

INTRODUCTION

Congratulations on your selection of an RDL HD-Series High-Efficiency commercial mixer amplifier. The HD-MA35A is part of the world's highest performance full-featured high-efficiency mixer amplifier series for commercial installations. This product includes a studio quality microphone input stage, line-level transformer isolation, equalization, remote control capability and integral analog compression coupled to a sonically pleasing analog-filtered high efficiency Zone 1 Class D output stage. The HD-Series mixer amplifiers are designed and manufactured in the U.S.A. using the most advanced automated manufacturing and testing processes for years of reliable high performance and cost savings.

CONNECTIONS

USE ONLY THE POWER SUPPLY SUPPLIED WITH THE MODULE.



USE ONLY THE TERMINAL BLOCK SUPPLIED WITH THE MODULE.



OUTPUT CONNECTIONS MUST BE MADE BY PERSONS ADVISED OR SUPERVISED TO AVOID DANGERS AND PREVENT RISKS WHICH ELECTRICITY MAY CREATE.

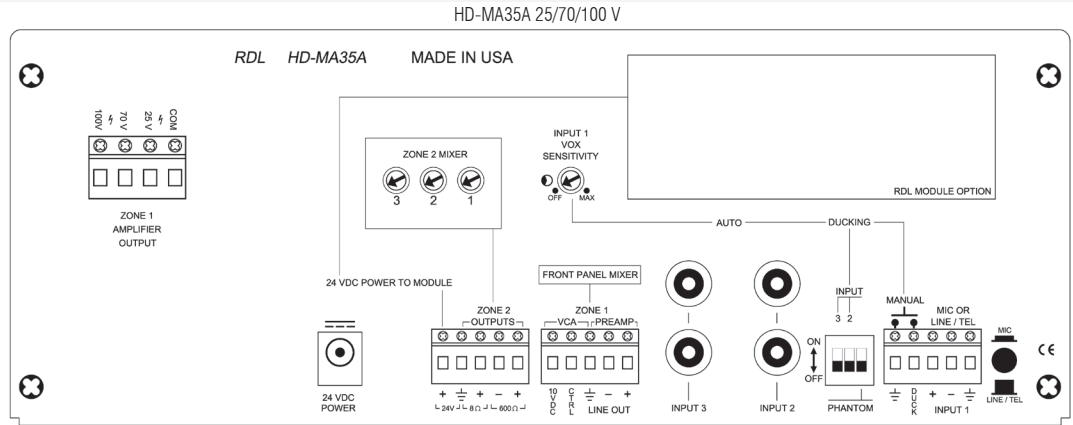

Connections are made on the rear panel. All connections are on detachable terminal blocks or connectors. The Zone 2 mixer, Input 1 MIC/LINE switch, ducking controls and assignments and phantom voltage selector are also provided on the rear panel. The Zone 1 mixer, tone controls, indicators and power button are on the front panel.

INPUT WIRING

Balanced MIC or LINE source connected using a single-pair shielded audio cable

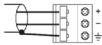

Balanced LINE signal from phone PBX or audio transformer



Unbalanced MIC or LINE source connected using a single-conductor shielded audio cable

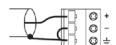

Three inputs may be connected. Each input is available on the primary Zone 1 front-panel mixer and on the Zone 2 rear-panel mixer. If used, the paging source is usually connected to Input 1.

INPUT 1

PHANTOM VOLTAGE

If a condenser mic may be connected to INPUT 1, set the phantom voltage ON (switch up).

MIC or LINE Gain

Set the Input Gain to MIC or LINE/TEL according to the input signal connected.

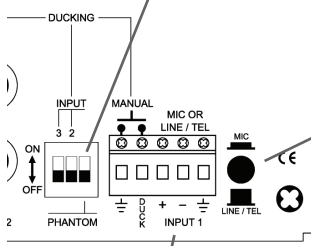

INPUT 1

Connect a MIC or LINE source. This is normally a paging mic or the line-level paging output from a phone PBX. The line-level input is transformer balanced (providing galvanic isolation) and may be connected balanced or unbalanced.

INPUTS 2 & 3

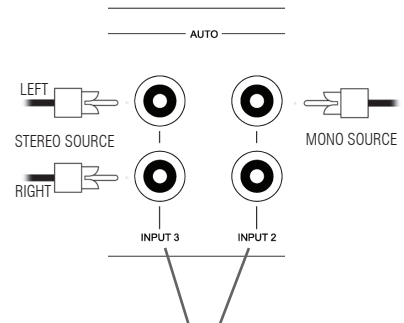

INPUTS 2 & 3

Connect a mono or stereo standard unbalanced -10 dBV audio source to INPUTS 2 and/or 3. The two input jacks associated with each input provide active summing of the left and right channels, thereby preserving the stereo separation of the audio source.

PRIORITY PAGING

VOX (VOICE-ACTIVATED PRIORITY)

If a paging signal is to automatically "duck" (fade down) other audio inputs, feed a normal paging signal into INPUT 1 and adjust the SENSITIVITY trimmer until the LED flashes regularly. Set the SENSITIVITY trimmer fully CCW to disable the VOX function.

INPUT DUCKING SELECTOR

Select one or both inputs (2 and/or 3) to be ducked when a paging priority is detected (VOX activated by audio signal on INPUT 1, or MANUAL activation by an external switch). Selected inputs are ducked only in Zone 1 (the primary amplified output). Set the switch ON (switch up) to duck the input in Zone 1; set the switch OFF to prevent ducking. Inputs are not ducked in Zone 2.

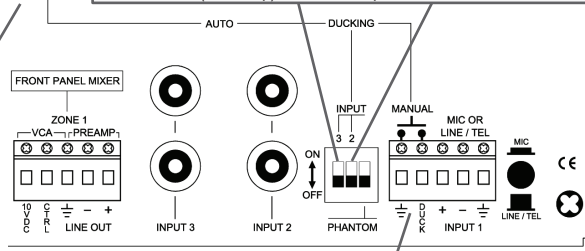

MANUAL PRIORITY

If a switch (such as a momentary paging mic push-to-talk switch) should "duck" (fade down) other audio inputs, connect the switch to the DUCK and Ground terminals.

REMOTE CONTROL FOR ZONE 1 AMPLIFIER OUTPUT

MASTER VCA REMOTE CTRL

Connect the VCA terminals directly to an RDL remote control. (Examples providing a single volume control location: RLC10K or RLC10KS; RLC10KM or RLC10KMS with pushbutton muting) Other RDL remote controls are available to provide multiple control locations. Visit rdlnet.com for details. The VCA may be controlled by an external 10 kOhm linear pot or from other equipment control outputs that provide 0 to 10Vdc.

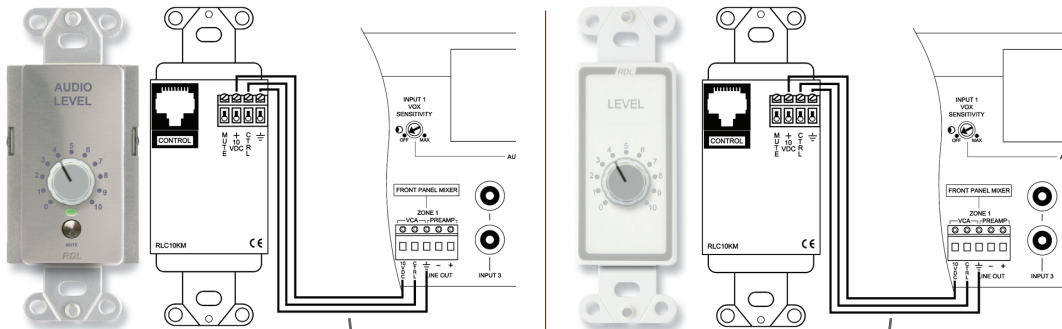

Wiring may be unshielded or single-pair shielded (connect the shield between the ground terminals). Shielded wiring is recommended for installations in environments where radio frequency emissions may be present.

External 10k Pot (Linear Taper)

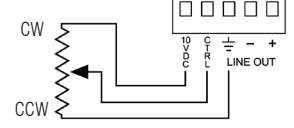

External Control 0 to 10 V

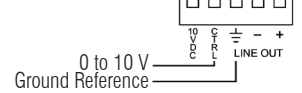

EXTERNAL MODULES

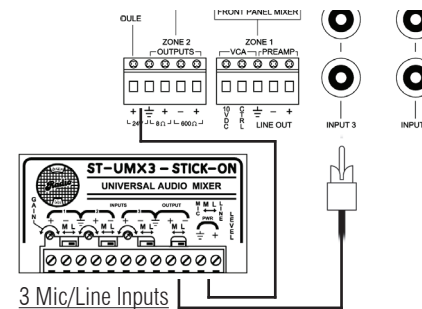

MODULE MOUNTING AREA

This area is reserved for mounting RDL STICK-ON or TX-Series modules. The example shows a mixer module that provides additional inputs to the mixer amplifier. Other possibilities include equalizers, signal detectors, crossovers or processors.

MODULE POWER

24 Vdc, 100 mA is available to power external modules.

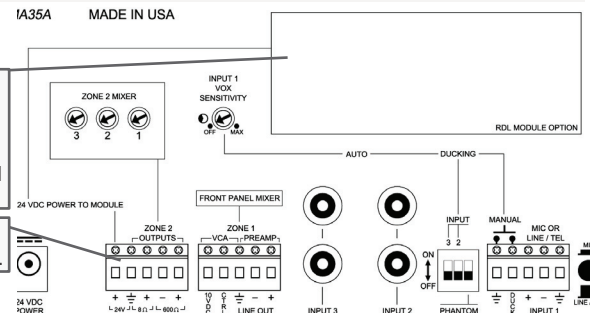

ZONE 1 OUTPUT CONNECTIONS

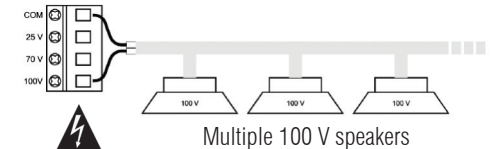
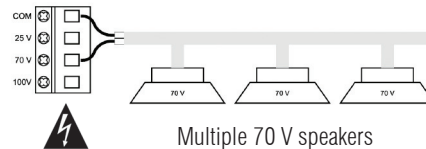
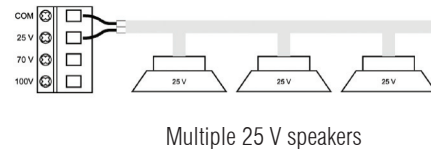

Unplug the power supply and remove the output terminal security cover. Connect constant voltage speakers to a single output voltage tap. Do not connect speakers with dissimilar voltages to multiple output taps. Total connected load must not exceed 35 W. Upon completion of the output terminal block wiring, re-install the cover over the terminal block prior to plugging in the power supply.

ZONE 2

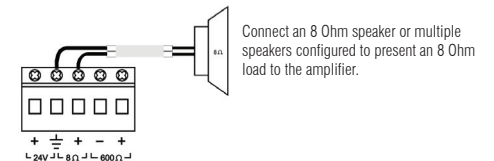
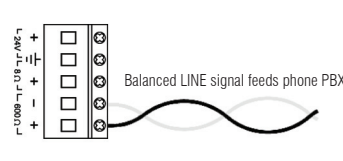
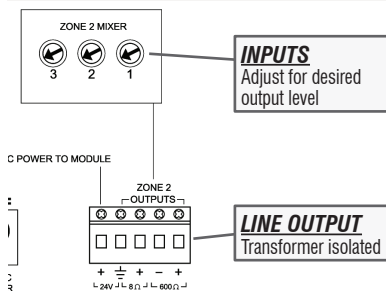

The Zone 2 mixer operates from the same 3 inputs as the front-panel Zone 1 mixer. Ducking assignments do not affect the signals in Zone 2. Each input source should be adjusted to the desired output level. Turn down unused inputs to remove them from the mix. Two Zone 2 outputs are provided. The 600 Ohm output is transformer isolated (providing galvanic isolation) to drive a phone PBX paging input or the input of another power amplifier. The 8 Ohm output drives an 8 ohm speaker with up to 2 W RMS.

ADDING ZONES

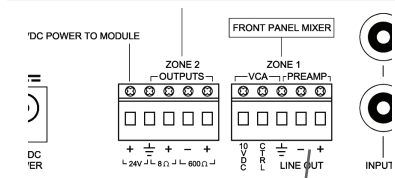

ADDITIONAL ZONE AMPLIFIERS

Connect the LINE OUTPUT to the line input of one or multiple additional RDL amplifiers to permit the Zone 1 mixer to feed other zones. The LINE OUTPUT is not controlled by the master VCA remote control so each additional zone may have its own master level control. The LINE OUTPUT provides "flat" audio without equalization by the front-panel tone controls. The LINE OUTPUT may also be used to feed recording equipment or an audio distribution amplifier.

OPERATION

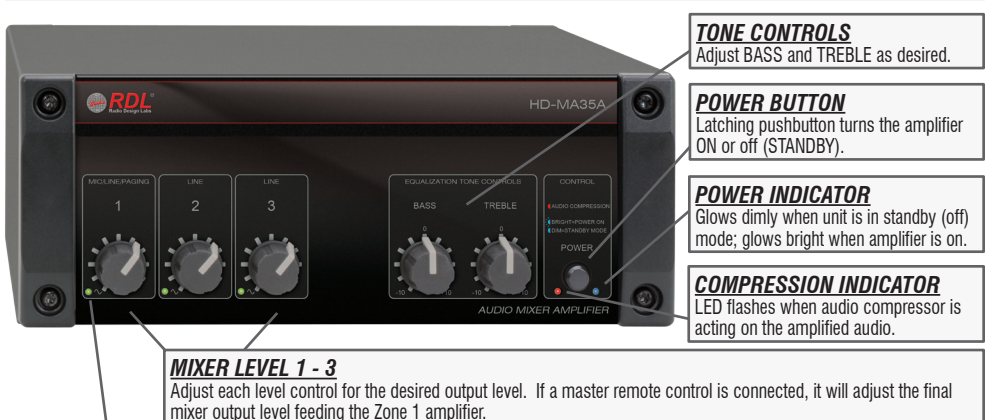

SIGNAL PRESENT 1 - 3 The green LED glows when audio is present at the input. The indication is not affected by the setting of the mixer level control.

Safety Instructions

Do not remove the cover or rear panel. This unit contains no user serviceable parts inside.

- 1) Read these instructions before operating the unit.
- 2) Keep these instructions.
- 3) Heed all warnings.
- 4) Follow all instructions.
- 5) Do not use this apparatus near water or moisture.
- 6) Clean only with dry cloth.
- 7) Do not block any ventilation openings. Install in accordance with the manufacturer's instructions.
- 8) Do not install near any heat sources such as radiators, heat registers, stoves, or other apparatus (including amplifiers) that produce heat.
- 9) Only use attachments/accessories specified by the manufacturer.
- 10) Unplug this apparatus during lightning storms or when unused for long periods of time.
- 11) Refer all servicing to qualified service personnel. Servicing is required when the apparatus has been damaged in any way, such as if the power-supply or plug is damaged, liquid has been spilled or objects have fallen into the apparatus, the apparatus has been exposed to rain or moisture, does not operate normally, or has been dropped.
- 12) To completely disconnect this apparatus from the AC mains, disconnect the power supply plug from the AC receptacle.
- 13) **WARNING** – To reduce the risk of fire or electric shock, do not expose this apparatus to rain or moisture.
- 14) Do not expose this equipment to dripping or splashing and ensure that no objects filled with liquids, such as vases, are placed on the equipment.
- 15) Warning labels may be attached to any surface (including the bottom) of the apparatus.



The exclamation point within an equilateral triangle is intended to alert the user to the presence of important operating and maintenance (servicing) instructions in the literature accompanying the product.



The lightning flash with arrowhead symbol, within an equilateral triangle, is intended to alert the user to the presence of uninsulated "dangerous voltage" within the product's enclosure that may be of sufficient magnitude to constitute a risk of electric shock to persons.

Consignes de sécurité

N'ôtez pas le couvercle ni le panneau arrière du boîtier. Cet appareil ne contient aucune pièce remplaçable par l'utilisateur.

- 1) Lisez ces instructions avant d'utiliser l'appareil.
- 2) Conservez ces instructions.
- 3) Respectez toutes les mises en garde.
- 4) Suivez toutes les instructions.
- 5) N'utilisez pas cet appareil près d'une source liquide ou dans un lieu humide.
- 6) Nettoyez-le uniquement avec un chiffon sec.
- 7) Ne bloquez pas aucune ouverture de ventilation. Installez l'appareil en suivant les instructions du fabricant.
- 8) Ne l'installez pas à proximité d'une source de chaleur, comme un radiateur, un four ou tout autre appareil (amplificateurs y compris) qui produisent la chaleur.
- 9) Utilisez uniquement les fixations/accessoires agréés par le fabricant.
- 10) Déconnectez l'appareil pendant les orages ou lors de périodes d'inutilisation prolongées.
- 11) Confiez toutes les réparations à un technicien qualifié. Vous devez faire contrôler cet appareil s'il a été endommagé de quelque façon que ce soit, comme lorsque l'alimentation ou les fiches sont endommagés, qu'un liquide ou des objets se sont infiltrés dans l'appareil, qu'il a été exposé à la pluie ou l'humidité, qu'il a subi un choc ou qu'il ne fonctionne pas normalement.
- 12) Pour déconnecter entièrement l'appareil du secteur, déconnectez la fiche de l'alimentation de la prise.
- 13) **MISE EN GARDE** – Pour réduire les risques d'incendie ou d'électrocution, n'exposez pas cet appareil aux intempéries ou à l'humidité.
- 14) N'exposez pas cet appareil à l'humidité ou aux projections liquides. Ne posez pas de récipient rempli de liquide, tel qu'un vase, sur cet appareil.
- 15) Des étiquettes d'avertissement peuvent être attachées à n'importe quelle surface (y compris le fond) de l'appareil.



Le point d'exclamation au centre d'un triangle équilatéral prévient l'utilisateur de la présence d'instructions importantes dans le mode d'emploi concernant la mise en oeuvre et l'entretien de l'appareil.



L'éclair de foudre fléché au centre d'un triangle équilatéral prévient l'utilisateur de la présence de courants élevés dans l'appareil, pouvant constituer un risque d'électrocution en cas de mise en contact avec les composants internes.

Instrucciones de seguridad

No quitar la tapa ni la parte posterior del chasis. Dentro del aparato no hay piezas susceptibles de ser reparadas por el usuario.

- 1) Lea estas instrucciones antes de comenzar a usar la unidad.
- 2) Conserve estas instrucciones.
- 3) Atienda todas las advertencias.
- 4) Siga todas las instrucciones.
- 5) No use este aparato cerca del agua o en lugares húmedos.
- 6) Limpie sólo con un paño seco.
- 7) No bloquee ningún orificio de ventilación. Instale de acuerdo con las instrucciones del fabricante.
- 8) No lo instale cerca de ninguna fuente de calor, como radiadores, registros de calefacción, estufas u otros aparatos (incluidos los amplificadores) que produzcan calor.
- 9) Use únicamente aditamentos o accesorios especificados por el fabricante.
- 10) Desenchufe este aparato durante las tormentas eléctricas o cuando no se use durante períodos prolongados de tiempo.
- 11) Refiera todo el servicio a personal cualificado. Se requiere servicio cuando el aparato se ha dañado de cualquier forma, como si se dañan el cable de alimentación o la clavija, si se ha vertido un líquido o han caído objetos al interior del aparato, si el aparato ha estado expuesto a la lluvia o la humedad, no funciona normalmente o ha caído.
- 12) Para desconectar completamente este aparato de la red de CA, desconecte el alimentación eléctrica del receptáculo de CA.
- 13) **ADVERTENCIA** – Para reducir el riesgo de incendio o descarga eléctrica, no exponga este aparato a la lluvia o la humedad.
- 14) No exponga este equipo a escurrimientos o salpicaduras, y asegúrese de que no se coloquen objetos llenos de líquido, como jarrones, sobre el equipo.
- 15) Las etiquetas de advertencia se pueden sujetar a cualquier superficie (parte inferior incluyendo) del aparato.



El signo de exclamación dentro de un triángulo equilátero alerta al usuario de la existencia de importantes instrucciones sobre funcionamiento y mantenimiento (asistencia) en el manual que acompaña al equipo.



El símbolo del relámpago con punta de flecha, dentro de un triángulo equilátero, alerta al usuario de la presencia de un "voltaje peligroso" sin aislar en el interior del producto, que puede ser de la suficiente magnitud como para constituir un riesgo de descarga eléctrica para las personas.

Sicherheitsvorkehrungen

Um die Gefahr eines Stromschlags zu verringern, sollten Sie weder Deckel noch Rückwand des Geräts entfernen. Im Innern befinden sich keine Teile, die vom Anwender gewartet werden können.

- 1) Lesen Sie diese Anweisungen bevor Sie das Gerät in Betrieb nehmen.
- 2) Bewahren Sie diese Anweisungen auf.
- 3) Beachten Sie alle Warnhinweise.
- 4) Befolgen Sie alle Anweisungen.
- 5) Benutzen Sie die Vorrichtung nie in der Nähe von Wasser oder Feuchtigkeit.
- 6) Nur mit trockenem Tuch reinigen.
- 7) Belüftungsöffnungen nicht blockieren. Den Anweisungen des Herstellers entsprechend installieren.
- 8) Installieren Sie die Vorrichtung nicht in der Nähe von Wärmequellen wie Radiatoren, Heizkörpern, Herden oder anderen Geräten (insbesondere Verstärkern), die Wärme erzeugen.
- 9) Verwenden Sie nur vom Hersteller zugelassenes Zubehör.
- 10) Ziehen Sie bei Gewittern oder bei längeren Stillstandzeiten den Netzstecker des Geräts.
- 11) Überlassen Sie alle Wartungsarbeiten qualifiziertem Personal. Ein Service wird erforderlich, wenn das Gerät in irgendeiner Weise beschädigt wurde, beispielsweise bei Beschädigung des Netzteils oder des Netzkabels, wenn Flüssigkeiten über das Gerät vergossen wurden oder Gegenstände in das Gerät gefallen sind, das Gerät Regen oder Feuchtigkeit ausgesetzt war, nicht ordnungsgemäß funktioniert oder fallen gelassen wurde.
- 12) Ziehen Sie den Netzstecker aus der Steckdose, um das Gerät vollständig vom Wechselstromnetz zu trennen.
- 13) **WARNHINWEIS:** Um die Gefahr vom Feuer oder Stromschlag zu vermeiden, darf das Gerät nicht Regen oder Feuchtigkeit ausgesetzt werden.
- 14) Lassen Sie nicht zu, dass Flüssigkeiten auf das Gerät tropfen oder gespritzt werden können, und achten Sie darauf, dass keine mit Wasser gefüllten Gegenstände wie Vasen auf das Gerät gestellt werden.
- 15) Warnaufkleber können sich an beliebiger Stelle (inklusive Unterseite) am Gehäuse des Apparates befinden.



Das Ausrufezeichen im gleichseitigen Dreieck soll den Anwender auf wichtige Bedienungs- und Wartungsanleitungen aufmerksam machen, die im mitgelieferten Informationsmaterial näher beschrieben werden.



Der Blitz mit Pfeilspitze im gleichseitigen Dreieck soll den Anwender vor nichtisolierter "gefährlicher Spannung" im Geräteinnern warnen. Diese Spannung kann so hoch sein, dass die Gefahr eines Stromschlags besteht.