

**MODEL : SB-3879**

HDMI Video Scaler



## HDMI Video Scaler 7x2 (mirrored) Multi Format HDMI Video Scaler Selector Switch 7 In's Converted to VGA & HDMI Output

### *HDTV Distribution Amplifier Series*

*Thank you for purchasing the SB-3879 HDMI Video Scaler. You will find this unit easy to install and highly reliable but it is essential that you read this manual thoroughly before attempting to use this HDMI Video Scaler.*



## SAFETY INFORMATION



1. To ensure the best results from this product, please read this manual and all other documentation before operating your equipment. Retain all documentation for future reference.
2. Follow all instructions printed on unit chassis for proper operation.
3. To reduce the risk of fire, do not spill water or other liquids into or on the unit, or operate the unit while standing in liquid.
4. Make sure power outlets conform to the power requirements listed on the back of the unit. Keep unit protected from rain, water and excessive moisture.
5. Do not attempt to clean the unit with chemical solvents or aerosol cleaners, as this may damage the unit. Dust with a clean dry cloth.
6. Do not use the unit if the electrical power cord is frayed or broken. The power supply cords should be routed so that they are not likely to be walked on or pinched by items placed upon or against them, paying particular attention to cords and plugs, convenience receptacles, and the point where they exit from the appliance.
7. Do not force switched or external connections in any way. They should all connect easily, without needing to be forced.
8. Always operate the unit with the AC ground wire connected to the electrical system ground. Precautions should be taken so that the means of grounding of a piece of equipment is not defeated.
9. AC voltage must be correct and the same as that printed on the rear of the unit. Damage caused by connection to improper AC voltage is not covered by any warranty.
10. Turn power off and disconnect unit from AC current before making connections.
11. Never hold a power switch in the "ON" position.
12. This unit should be installed in a cool dry place, away from sources of excessive heat, vibration, dust, moisture and cold. Do not use the unit near stoves, heat registers, radiators, or other heat producing devices.
13. Do not block fan intake or exhaust ports. Do not operate equipment on a surface or in an environment which may impede the normal flow of air around the unit, such as a bed, rug, carpet, or completely enclosed rack. If the unit is used in an extremely dusty or smoky environment, the unit should be periodically "blown free" of foreign dust and matter.
14. To reduce the risk of electric shock, do not remove the cover. There are no user serviceable parts inside. Refer all servicing to qualified service personnel. There are no user serviceable parts inside.
15. When moving the unit, disconnect input ports first, then remove the power cable; finally, disconnect the interconnecting cables to other devices.
16. Do not drive the inputs with a signal level greater than that required to drive equipment to full output.
17. The equipment power cord should be unplugged from the outlet when left unused for a long period of time.
18. Save the carton and packing material even if the equipment has arrived in good condition. Should you ever need to ship the unit, use only the original factory packing.
19. Service Information Equipment should be serviced by qualified service personnel when:
  - A. The power supply cord or the plug has been damaged.
  - B. Objects have fallen, or liquid has been spilled into the equipment.
  - C. The equipment has been exposed to rain
  - D. The equipment does not appear to operate normally, or exhibits a marked change in performance
  - E. The equipment has been dropped, or the enclosure damaged.

# TABLE OF CONTENTS

## CONTENTS

INTRODUCTION .....	1
FEATURES.....	2
SPECIFICATIONS .....	3
FRONT PANEL .....	4
REAR PANEL .....	5
REMOTE CONTROL .....	8
IR CODES .....	9
IR EXTENDER .....	10
TYPICAL APPLICATION .....	11
RESOLUTION SUPPORT .....	12
VIDEO TIMING LIST .....	16
OSD OPTIONS OVERVIEW .....	20
LIMITED WARRANTY .....	26

## INTRODUCTION

Congratulations on your purchase of a professional high-performance scaler and thank you for your support of ShinybowUSA products. The SB-3879 is a video graphics scaler that accepts seven types of signals: analog video, S-Video, component video, VGA, DVI, HDMI, and display port signals.

It scales the input signals into either VGA or HDMI signals, supporting higher full HD resolutions of 480i/p, 720p, 1080i/p. Designed to solve problems of compatibility between source devices and monitors, it is also useful for delivering one single image on a TV wall. In addition to the front panel buttons and the IR remote control, users may gain control over the SB-3879 using a PC through the RS-232 serial port or Ethernet port.

## PACKAGE CONTENTS

Check that you have the following components:

- SB-3879 Video Scaler
- IR Remote Control
- Rack Mounts
- IR extender receiver
- RS-232 driver CD (All Windows Operating Systems)
- RS-232 cable
- Users Guide
- AC/DC Adapter: 12 VDC, 2A universal type switch 50/60Hz, 100-230 VAC

## SAFETY PRECAUTIONS

Please read all instructions before attempting to unpack, install or operate this equipment and before connecting the power supply. Please keep the following in mind as you unpack and install this equipment:

- Always follow basic safety precautions to reduce the risk of fire, electrical shock and injury to persons.
- To prevent fire or shock hazard, do not expose the unit to rain, moisture or install this product near water.
- Never spill liquid of any kind on or into this product.
- Never push an object of any kind into this product through any openings or empty slots in the unit, as you may damage parts inside the unit.
- Do not attach the power supply cabling to building surfaces.
- Use only the supplied power supply unit (PSU). Do not use the PSU if it is damaged.
- Do not allow anything to rest on the power cabling or allow any weight to be placed upon it or any person walk on it.
- To protect the unit from overheating, do not block any vents or openings in the unit housing that provide ventilation and allow for sufficient space for air to circulate around the unit.

## DISCLAIMERS

The information in this manual has been carefully checked and is believed to be accurate. We assume no responsibility for any infringements of patents or other rights of third parties which may result from its use.

We assume no responsibility for any inaccuracies that may be contained in this document. We make no commitment to update or to keep current the information contained in this document.

We reserve the right to make improvements to this document and/or product at any time and without notice.

## COPYRIGHT NOTICE

No part of this document may be reproduced, transmitted, transcribed, stored in a retrieval system, or any of its part translated into any language or computer file, in any form or by any means — electronic, mechanical, magnetic, optical, chemical, manual, or otherwise — without express written permission and consent

© Copyright 1997. All Rights Reserved.

Version 1.2 SEPT 2013

## TRADEMARK ACKNOWLEDGMENTS

All products or service names mentioned in this document may be trademarks of the companies with which they are associated.



# FEATURES

## FEATURES

- Supports HDMI 1.4a 30 formals and suits HDMI V1.4 transmitter & receiver
- Compliant with HDMI 1.4, DVI 2.0, and HDCP 2.0
- Input support:
  - Analog: analog video, S-Video, composite video, VGA
  - Digital: DVI, HDMI and display port (2560x1600)
- Output support: VGA and HDMI 1080p with deep color 36-bit
- Output audio support: S/PDIF, stereo audio
- Advanced 30 de-interlace, smooth edge algorithm and 3:2/2:2 film mode processing
- 3D format functions: frame packing, side-by-side, top/bottom adjustment
- Bypasses XGA & 720p 120Hz 3D signal for DLP link 3D ready projector for active 3D display
- Supports full HD @24Hz, full HD 3D signal, with special algorithm for RH/LH synchronization
- Supports wide range of HD resolutions ranging from XGA to WUXGA 1920x1200 to
- HDTV/DTV resolutions 480i/480p, 576i/576p, 720p, 1080i & 1080p
- Compatible with all HDMI source devices, PC monitors, plasma HD display, HDTV and audio receivers/amplifiers
- Supports intelligent color adjustment (discrete RGB color adjustment, hue, saturation, sharpness, contrast, brightness, and preset color modes)
- Rack mountable: 19-inch ear rack mount
- Various user interface control:
- Windows-based GUI control via RS-232 port
  - Front panel push buttons, IR wireless remote control, Third party RS-232 controller (via simple ASCII), Ethernet
- Supports IR extender with maximum extend distance reaching 1000 feet / 300 meters
- Supports TV wall function, allowing the image to be divided on multiple displays/monitors
- Power supply DC 12V, universal type switch, 100-240 VAC, 50/50Hz

# SPECIFICATIONS

## SPECIFICATIONS

**Scaler Type:** 7 in 2 out HDMI Video Scaler

**Video Input Signal:** 1x Composite / 1x S-Video /1x Component / 1x VGA / 1x DVI / 1x HDMI / 1x DP

**Audio Input Signal:** Digital Audio (PCM), Stereo Audio

**Video Output Signal:** 1x RGB, 1x HDMI

**Audio Output Signal:** 1x S/PDIF Digital Audio, 1x Analog, Audio RH/LH, 1x HDMI Audio

**3D Support:** 3D Video Format in HDMI 1.4a (225MHz)

**Input Resolution:** Up to 1080p-60, 1920x1200, and DP 2560x1600

**Output Resolution:** Up to 1080p-60 and 1920x1200

**Source Status:** Automatic scanning of input/output status

**HDCP Support:** DVI/ HDMI/ Display Port, compliant with HDCP 2.0

**HDMI Compliance:** HDMI 1.4a receiver and transmitter

**HDMI Cable Distance:** Max. ~ 50 feet (15 meters), depending on cable quality

**Infrared Frequency:** 38KHz

**Chassis Material:** Metal

**IR Extend Distance:** ~1000 feet (300 meters) line cable via IR extender

**Control:** IR remote control, RS-232, front panel push buttons

**Dimensions:** 11.96 x 5.90 x 1.73 in (304x150x11mm)

**Rack Mount:** 19-inch panel type (1U-44L)

**Power Supply:** Input 100 ~ 240 VAC, 50/60 Hz / Output DC 12V, 3A

**Safety Approvals:** CE, FCC, RoHS (2002/95/EC)

**Temperature:** 32 ° F ~ 100 ° F (0 ° ~32 ° C)

**Shipping Weight:** 2.05 Kgs / 3.42 lbs

### Video Wall:

- Magnify, scroll, pan through all inputs
- Video wall function: Image split, cropping, and assign display location
- Pixel based overlap adjustment in all edges, up to 15x15 matrix displays
- Up to 2560x1600 input resolution via display port

### System Control:

- Box ID for easy independent control through IR, RS-232, and 5 selectable profile settings for difference display
- Ethernet control module with RJ45 connector
- Code update through RS-232
- ASCII control protocol over RS-232 and Ethernet
- One DC 12V/1A trigger output

### Advanced Video Processing:

- Advanced 3D de-interlace, smooth edge algorithm and 3:2/2:2 film mode
- High quality video and graphics scaling up and down
- Frame rate conversion

### Intelligent Color Adjustment:

- Discrete RGB, color adjustment, hue, saturation, sharpness, contrast, brightness, 4 preset color modes

### 3D Function:

- Auto detect standard 3D signal (with 3D index inside) from Blu-ray DVD or STB
- Supports full HD @ 24 Hz full HD 3D signal with special algorithm for RH/LH synchronization
- Bypass XGA & 720p 120 Hz 3D signal for DLP link
- 3D ready projector for active 3D display

As product improvements are continuous, specifications are subject to change without notice.

# FRONT PANEL

## FRONT PANEL

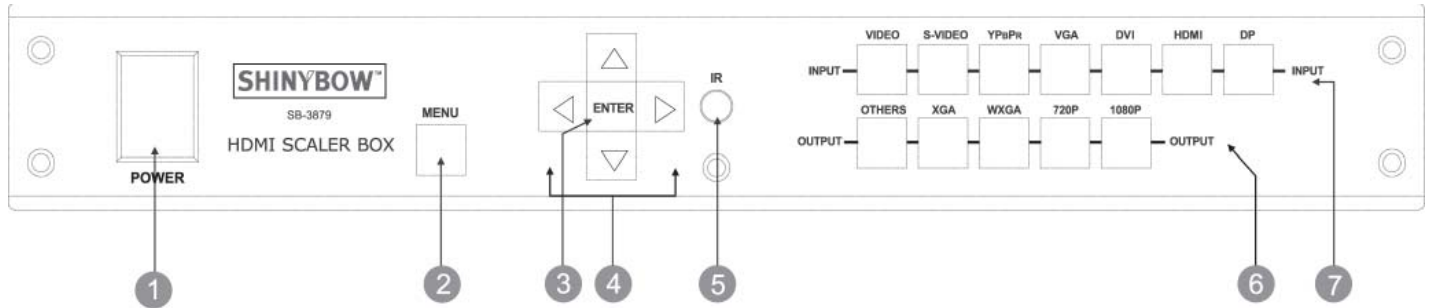

### 1. POWER ON SWITCH

The power switch turns the unit on and off. The LED will illuminate blue to indicate the switcher is ON and receiving power. The scaler will remember the last setting during a power cycle. When turned on again, it will automatically apply the setting last used.

### 2. MENU

Press menu to open the On-Screen Display interface. Press again to exit menu

### 3. ENTER

Press enter to confirm your entries.

### 4. ARROW KEYS

Use the arrow keys to move between the On-Screen Display options. Press the up key to enter the upper layer and the down key to enter the next layer. Press the left and right keys to select options in the same layer or change the value of a parameter.

### 5. IR SENSOR

The IR sensor receives IR commands from the supplied remote controller or a third party IR remitter.

### 6. OUTPUT SELECT BUTTONS

Select the desired resolution supported by your display devices. Press OTHERS for resolutions other than XGA, WXGA, 720p, 1080p. The button will illuminate blue to indicate it is selected. Advanced resolution adjustment can be found in the OSD options.

### 7. INPUT SELECT BUTTONS

Select from one of the 7 buttons the video signal you intend to be scaled. The button will illuminate blue to indicate it is selected.

# REAR PANEL

## REAR PANEL

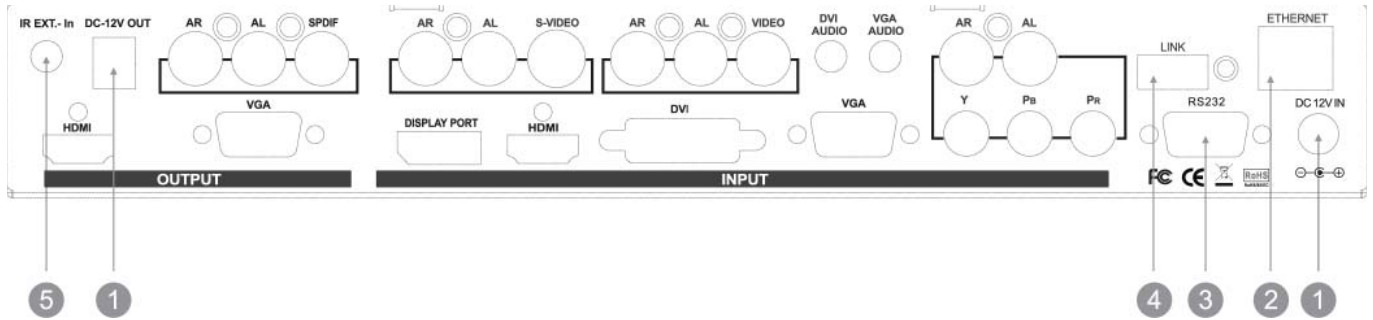

### 1. DC POWER INLET

The scaler suits a DC power plug-pack input connector. Please ensure the plug-pack used is of an approved type and of correct current, voltage output, and connector polarity. DV 12 Volt, power supply 2A.

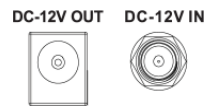

Power Jack:

DC Jack - Inner OD 2.1mm (+)  
Outside OD 5.5mm (GND)  
Power input - 12VDC, 2A

### 2. ETHERNET CONNECTION

Connect a CAT5 cable to the Ethernet port for control of the scaler from a computer.

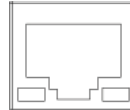

SPSC / RJ 45 connector

### 3. RS-232 CONNECTION

Connect a serial cable to the RS-232 port for control at the scaler from a computer.

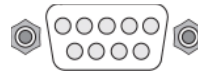

D-SUB 9-pin female connector

### 4. LINK

Connect the link port for firmware updates. Used for testing purpose.

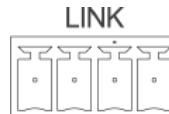

Terminal block connector

### 5. IR EXTENDER CONTROL

Supports remote control via IR extender. Maximum extend distance reaches 1000 feet (300 meters).



IR Extender Jack:

Female Jack - inner OD 3.5 mm

# REAR PANEL

## REAR PANEL

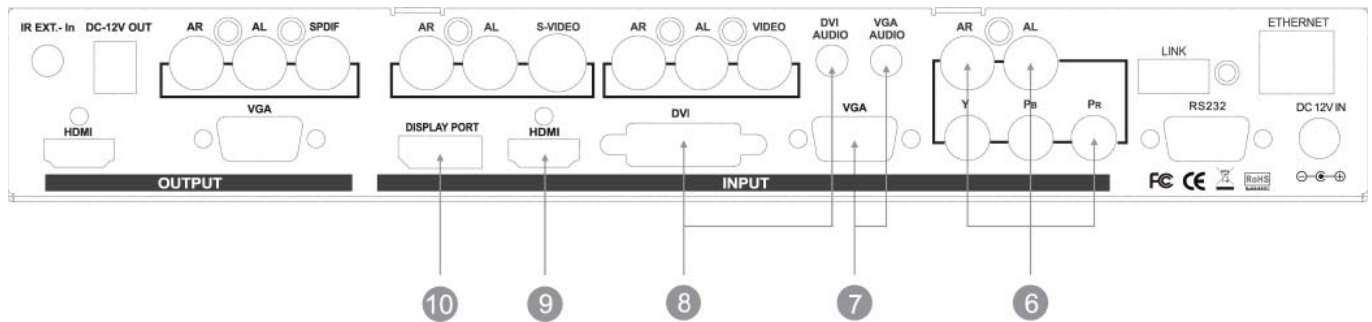

### 6. YPBPR + AR / AL AUDIO INPUT

Connect a signal of component video directly to the female RCA connector, which supports component video (YPBPR) to HDTV display devices. Connect the output port of your source audio device to the AR/AL inputs.

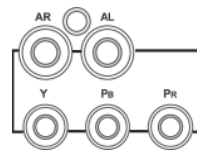

Component video via 3x RCAs  
Female RCA connectors  
Stereo audio via 2x RCAs  
Female RCA connectors

### 7. VGA + VGA AUDIO INPUT

Connect a signal of VGA (RGBHV) to the HD-15F female connector. Connect the output port of your source audio device to the audio input.

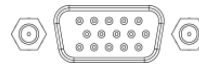

VGA video jack  
Female HD-15F connector

### 8. DVI + DVI AUDIO INPUT

Connect a signal of DVI to the digital video connector. Connect the output port of your source audio device to the audio input.



Female DVI connector

### 9. HDMI INPUT

Connect 8 signal link of HDMI direct digital video/audio to the HDMI connector, which supports HDMI digital video/audio and DVI digital video sources.

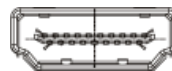

HDMI female jack

### 10. DISPLAY PORT INPUT

Connect a signal of display port to the DP port, which supports digital video and audio.



Display port digital video and audio connector



# REAR PANEL

## REAR PANEL

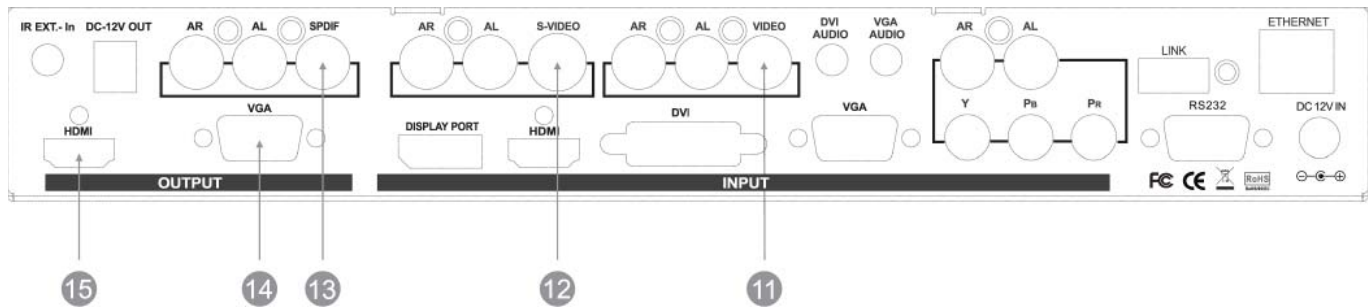

### 11. VIDEO + AR | AL AUDIO INPUT

Connect a signal of composite video to the RCA connector.  
Connect the output port of your source audio device to the AR/AL inputs.



Female RCA connector Stereo Audio (AR/AL) Via 1x 03.5mm ear phone jack connector  
Note: With 1x female phone jack each channel

### 12. S-VIDEO + AR / AL AUDIO INPUT

Connect a signal input of S-Video to the connector. Connect the output port of your source audio device to the AR/AL inputs.



Mini-DIN connector Stereo Audio (AR/AL) Via 1x 03.5mm ear phone jack connector  
Note: With 1x female phone jack each channel

### 13. SPDIF

Connect for digital audio output.



Female RCA connector

### 14. VGA OUTPUT

Connect a signal source of VGA(RGBHV) to the VGA connector.



Component Video (YPBPR) Via 3x RCAs  
Note: With 3x RCA female connectors.

### 15. HDMI OUTPUT

Connect a signal link of HDMI direct digital video/audio to this Female HDMI connector, which supports HDMI digital video/audio and DVI digital video sources.



HDMI digital video/audio connector  
HDMI female connector  
Note: With proper adapters, the scaler can be used with DVI digital video signals, and HDCP compliant.

# REMOTE CONTROL

## Before making any connections to the SB-3879. Observe the following:

Ensure the mains voltage supply matches the label on the supplied plug- Pack (+/- 10%)

Ensure that the power switch is OFF

Ensure that all system grounds (earth) are connected to a common point.

Avoid powering equipment within a system from multiple power sources that may be separated by large distances

Connect all audio video sources and destination equipment

Power up all source and destination audio-visual sources

For each destination output select the appropriate input source by using The front panel input select buttons. The supplied IR remote control. Or through the RS-232 serial communications port.

Upon power up the switcher will return to its last used setting before Powered down.

## REMOTE CONTROL

For guidance on the OSD options, please refer to the OSD instruction manual.

### IR REMOTE CONTROL KEY :

**1/2. POWER ON AND OFF:** Turns on or off the scaler

**3. MUTE:** Stops playing sounds

**4. SOURCE (HDMI, VGA, DVI, DP, YPBPR, VIDEO, S-VIDEO):**

Selects your input signal type

**5. ENTER:** Confirms your selection/enter the next layer of OSD options

**6. ARROW KEYS:** move up, down, left or right between the OSD options. Use left and right keys to adjust the value of a parameter. Use down key to enter the next layer of options and up key to move back.

**7. RETURN:** Return to the upper layer of OSD options

**8. MENU:** Opens up the OSD menu

**9. INFO:** Checks the connection status of input/output/ RS-232/Ethernet ports

**10. EXIT:** Leaves the OSD menu

**11. OUTPUT (XGA, WXGA, 720P, 1080P, OTHERS):** Selects the desired output resolution supported by your display device.

**12. OSD TIME OUT:** Adjusts the OSD menu display time

**13. VIDEO WALL:** Opens the video wall options

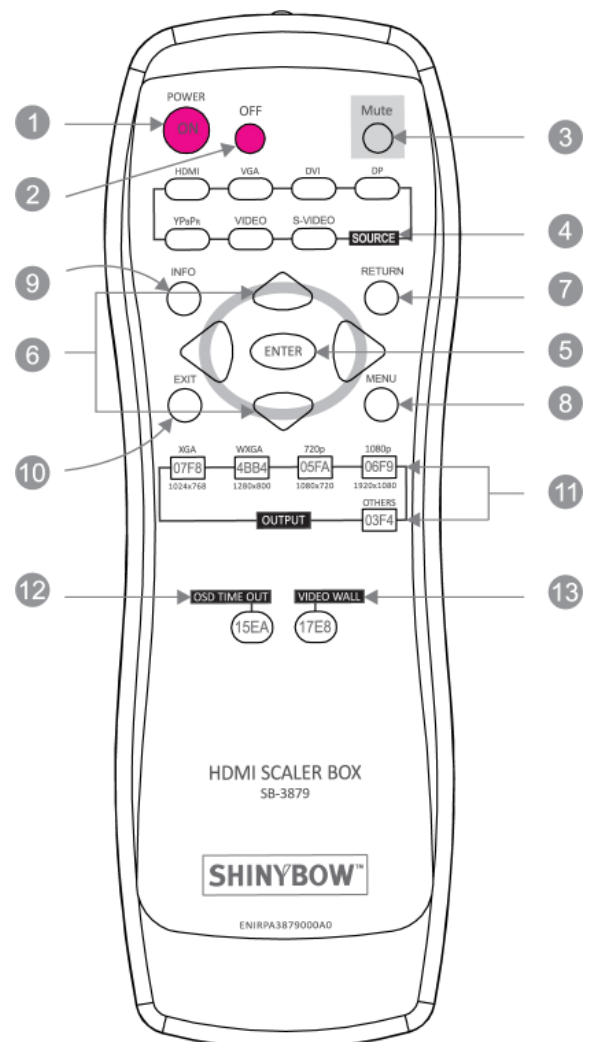

# IR CODES

## IR REMOTE CUSTOM AND DATA CODES (NEC STANDARD)

### HOW TO SETUP IR CODES:

CUSTOM CODE: 20DF

POWER ON: 20DF 5DA2  
POWER OFF: 20DF 5EA1  
Mute: 20DF 02FD

HDMI: 20DF 1FEO  
VGA: 20DF OAF5  
DVI: 20DF 50AF  
DP: 20DF 59A6  
YPBPR: 20DF 58A7  
VIDEO: 20DF 5AA5  
S-VIDEO: 20DF 5BA4

RETURN: 20DF 11EE  
MENU: 20DF 19EA  
INFO: 20DF 1BE4  
EXIT: 20DF 5CA3

ENTER: 20DF 51AE  
UP: 20DF 44BB  
RIGHT: 20DF 48B7  
LEFT: 20DF 1CE3  
DOWN: 20DF 1DE2

XGA: 20DF 07F8  
WXGA: 20DF 4BB4  
720p: 20DF 05FA  
1080p: 20DF 06F9  
OTHERS: 20DF 03FC

OSD TIME OUT: 20DF 15EA  
VIDEO WALL: 20DF 15EB

### Example 1: Select input VGA and output HDMI

The IR Data Code: 20DF OAF5 20DF 07F8

### Example 2: Open OSD-> move right -> move down to next layer -> enter to confirm selection

The IR Data Code: 20DF 15EA 20DF 48B7 20DF 1DE2 20DF 51AE

# IR EXTENDER

## REAR PANEL IR EXTENDER PORTS

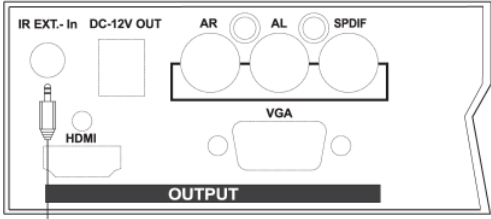

## IR EXTENDER CONNECTION

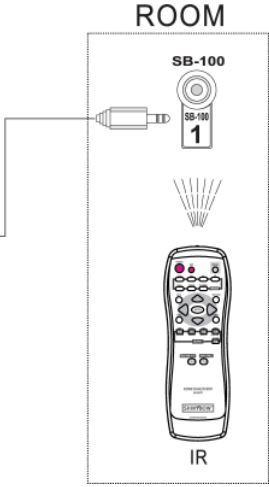

DISTANCE maximum 300 M / ~ 1000 feet

SHINYBOW SB-3879  
 IR Extender to a room  
 IR part number : SW-3879  
 IR Receiver : SB-100 (included)

••• When you plug the external IR extender into the scaler, the front panel IR receiver remains active . •••

## IR EXTENDER PACKAGE :

### HOW TO SETUP THE IR EXTENDER COMPONENTS

#### Step 1

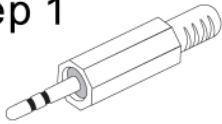

Tip:Signal  
 Ring:VCC  
 Sleeve:GND

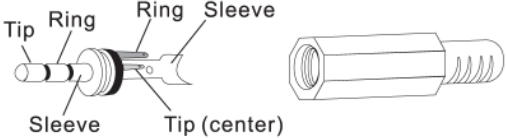

#### Step 2

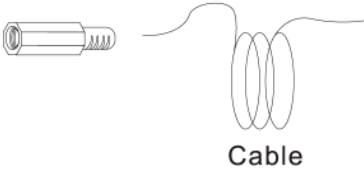

#### Step 3

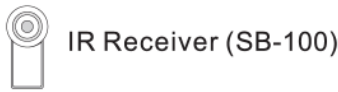
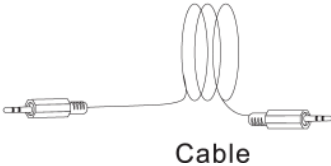
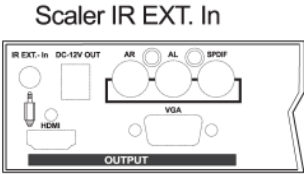
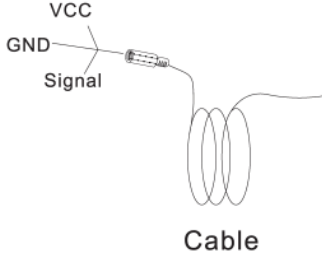
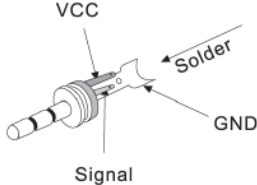

# TYPICAL APPLICATION

## 7 IN 2 OUT HDMI VIDEO SCALER

SHINYBOW  
SB-3879

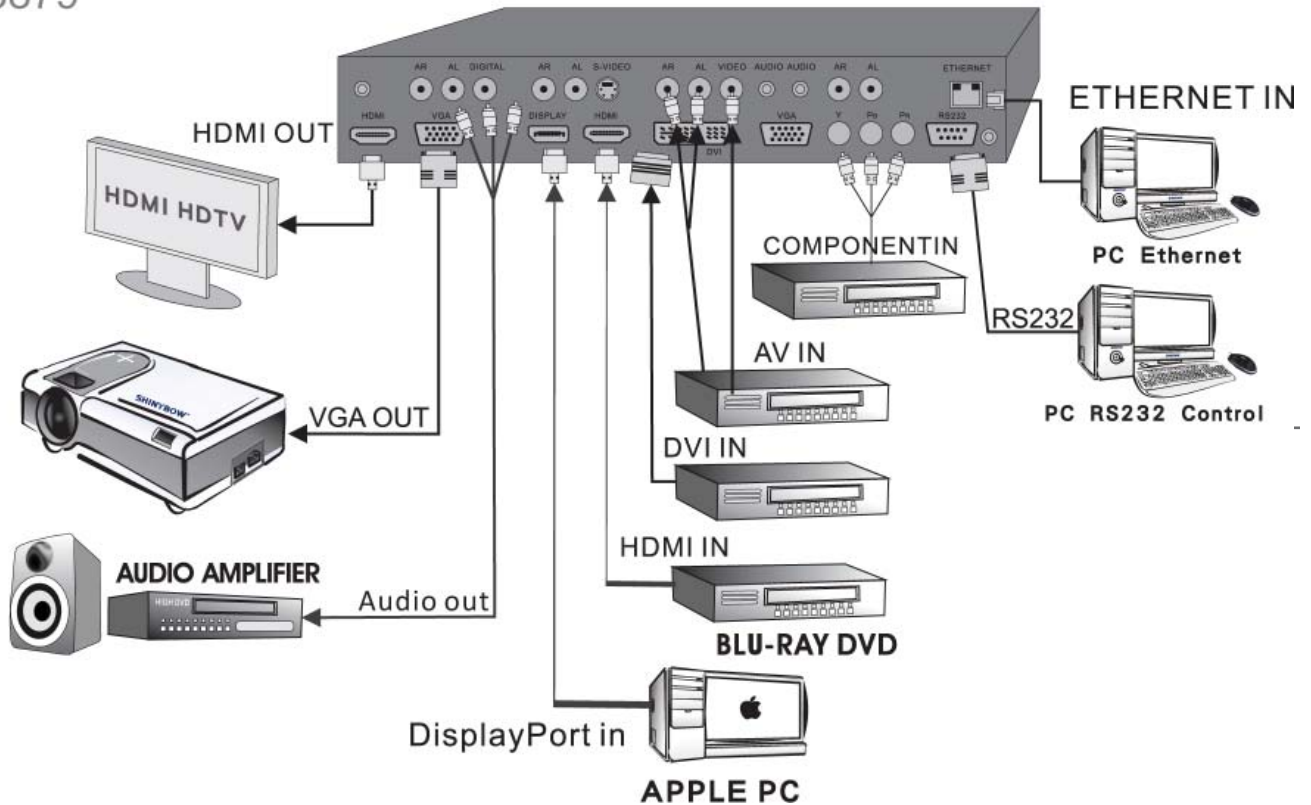

## INSTALLING

### CONTROL PORTS :

1. Front Panel - Function Key Press Buttons
2. IR Remote - IR Remote Controller
3. RS-232 Interface - RS-232 Interface System
4. Ethernet - Ethernet Interface System

**INPUTS 1 ~ 7 PORT SOURCE SIGNALS :** COMPONENT VIDEO, AV, DVI, HDMI, Display Port (5 input ports connected)

**OUTPUTS 1 ~ 2 PORT DISPLAY SIGNALS :** VGA, HDMI

SB-3879 SUPPORTS 7x INPUTS AND 2x OUTPUTS, CONTROL IR & RS-232 INTERFACE SYSTEM PORTS.

# INPUT RESOLUTION SUPPORT

Resolution		INPUT				
		COMPONENT	VGA	DVI	HDMI	Display Port
640x350 @ 85 Hz	480p / 480i	✓		✓	✓	✓
640x400 @ 85 Hz	576p / 576i			✓	✓	✓
640x480 @ 60 Hz	720p	✓	✓	✓	✓	✓
640x480 @ 72 Hz	VGA			✓	✓	✓
640x480 @ 75 Hz	VGA		✓	✓	✓	✓
720x400 @ 70 Hz	DOS		✓	✓	✓	✓
720x400 @ 85 Hz	1080p / 1080i	✓	✓	✓	✓	✓
800x600 @ 56 Hz	SVGA			✓	✓	✓
800x600 @ 60 Hz	SVGA		✓	✓	✓	✓
800x600 @ 72 Hz	SVGA		✓	✓	✓	✓
800x600 @ 75 Hz	SVGA		✓	✓	✓	✓
832x624 @ 75 Hz	SVGA		✓	✓	✓	✓
848x480 @ 59 Hz	WVGA		✓	✓	✓	✓
848x480 @ 60 Hz	WVGA		✓	✓	✓	✓
852x480 @ 60 Hz	480p		✓			
1024x768 @ 60 Hz	XGA		✓	✓	✓	✓
1024x768 @ 70 Hz	XGA			✓	✓	✓
1024x768 @ 75 Hz	XGA			✓	✓	✓
1152x864 @ 75 Hz	XGA+		✓	✓	✓	✓
1280x720 @ 48 Hz	HD 720		✓			
1280x720 @ 50 Hz	HD 720		✓	✓	✓	✓
1280x720 @ 60 Hz	HD 720		✓	✓	✓	✓
1280x768 @ 60 Hz	WXGA		✓	✓	✓	✓
1280x768 @ 75 Hz	WXGA		✓	✓	✓	✓
1280x768 @ 60 RB	WXGA		✓		✓	✓
1280x800 @ 60 Hz	WXGA		✓		✓	✓
1280x800 @ 75 Hz	WXGA		✓		✓	✓

# INPUT RESOLUTION SUPPORT

Resolution		INPUT				
		COMPONENT	VGA	DVI	HDMI	Display Port
1280x960 @ 60 Hz	SXGA		✓		✓	✓
1280x1024 @ 60 Hz	SXGA		✓	✓	✓	✓
1280x1024 @ 75 Hz	SXGA		✓	✓	✓	✓
1360x768 @ 60 Hz	SXGA		✓	✓	✓	✓
1360x768 @ 75 Hz	SXGA		✓			
1366x768 @ 60 Hz	WXGA		✓			
1400x788 @ 60 Hz	WXGA+		✓			
1400x1050 @ 60 Hz	SXGA+		✓	✓	✓	✓
1400x1050 @ 75 Hz	SXGA+		✓	✓	✓	✓
1400x1050 @ 60 RB	SXGA+		✓		✓	✓
1440x900 @ 60 Hz	WXGA+		✓		✓	✓
1440x900 @ 75 Hz	WXGA+				✓	✓
1440x1050 @ 60 Hz	SXGA+		✓	✓	✓	✓
1600x1200 @ 60 Hz	UXGA		✓	✓	✓	✓
1600x1200 @ 65 Hz	UXGA		✓			
1600x1200 @ 70 Hz	UXGA		✓			✓
1600x1200 @ 75 Hz	UXGA					✓
1680x1050 @ 60 Hz	WSXGA+		✓	✓	✓	✓
1792x1344 @ 60 Hz			✓			
1856x1392 @ 60 Hz			✓			
1920x1200 @ 60 RB	WUXGA		✓			
1920x1200 @ 60 Hz	WUXGA			✓	✓	✓
1920x1440 @ 60 Hz	WUXGA			✓	✓	✓
1920x1440 @ 75 Hz	WUXGA			✓	✓	✓
720x480p @ 59 Hz	DVD "NTSC"			✓	✓	✓
720x480p @ 59 PW	DVD "NTSC"			✓	✓	✓
720x576p @ 50 Hz	DVD "PAL"			✓	✓	✓

# INPUT RESOLUTION SUPPORT

Resolution		INPUT				
		COMPONENT	VGA	DVI	HDMI	Display Port
720x576p @ 50 PW	DVD "PAL"			✓	✓	✓
1280x720p @ 50 Hz	HDTV 720p			✓	✓	✓
1280x720p @ 60 Hz	HDTV 720p		✓	✓	✓	✓
1280x720p @ 100 Hz	HDTV 720p			✓	✓	✓
1280x720p @ 120 Hz	HDTV 720p			✓	✓	✓
1920x1080p @ 24 Hz	1080p HD				✓	✓
1920x1080p @ 30 Hz	1080i HD				✓	✓
1920x1080p @ 50 Hz	1080p HD				✓	✓
1920x1080p @ 60 Hz	1080p HD		✓	✓	✓	✓
1920x1080p @ 24 Hz	Full HD 1080p					✓
2048x1280 @ 60 Hz			✓			
2560x1600	WQXGA					✓



# OUTPUT RESOLUTION SUPPORT

Front Panel Buttons	Resolution	OUTPUT	
		VGA	HDMI
OTHERS	720x480	✓	✓
	800x600	✓	✓
	1280x800	✓	✓
	1280x1024	✓	✓
	1360x768	✓	✓
	1400x1050	✓	✓
XGA	1600x1200	✓	✓
WXGA	1920x1200	✓	✓
720p	1024x768	✓	✓
1080p	1280x720	✓	✓
1080p	1920x1080	✓	✓

**Note:** When the front panel button OTHERS is pressed, the scaler will automatically apply the resolution 1360x768. Users may continue pressing OTHERS to cycle through the following four resolutions: 1360x768 -> 1280x1024 -> 1600x1200 -> 1920x1200

To select 720x480, 800x600, 1280x800, open the OSD menu and go to the IMAGE PROPERTIES to adjust the settings in the output mode.

# VIDEO TIMING LIST (HDMI)

Resolution		H Freq. (Khz)	V Freq. (Hz)	Pixel Clock (MHz)	H Total Pixel	H Display Pixel	H Front Porch	H Sync Width	H Sync Pol	V Total Lines	V Display Lines	V Front Porch	V Sync Width	V Sync Pol
640x480	@ 60 Hz	31.484	59.97	25.1875	800	640	16	96	N	525	480	10	2	N
640x480	@ 72 Hz	37.861	72.809	31.5	832	640	24	40	N	520	480	9	3	N
640x480	@ 75 Hz	37.5	75	31.5	840	640	16	64	N	500	480	1	3	N
720x400	@ 70 Hz	31.458	70.063	28.3125	900	720	16	108	N	449	400	13	2	P
800x600	@ 56 Hz	35.156	56.25	36	1024	800	24	72	P	625	600	1	2	P
800x600	@ 60 Hz	37.879	60.317	40	1056	800	40	128	P	628	600	1	4	P
800x600	@ 72 Hz	48.077	72.188	50	1040	800	56	120	P	666	600	37	6	P
800x600	@ 75 Hz	46.875	75	49.5	1056	800	16	80	P	625	600	1	3	P
848x480	@ 59 Hz	29.83	59.659	31.5	1056	848	24	80	N	500	480	3	5	P
848x480	@ 60 Hz	31.02	60	33.75	1088	848	16	112	P	517	480	6	8	P
1024x768	@ 60 Hz	48.363	60.004	65	1344	1024	24	136	N	806	768	3	6	N
1024x768	@ 70 Hz	56.476	70.069	75	1328	1024	24	136	N	806	768	3	6	N
1024x768	@ 75 Hz	60.023	75.029	78.75	1312	1024	16	96	P	800	768	1	3	P
1152x864	@ 75 Hz	67.5	75	108	1600	1152	64	128	P	900	864	1	3	P
1280x720	@ 48 Hz	35.539	47.961	58	1632	1280	48	128	N	741	720	1	3	P
1280x720	@ 50 Hz	36.918	49.822	60.25	1632	1280	48	128	N	741	720	1	3	P
1280x720	@ 60 Hz	44.621	59.814	74.25	1664	1280	56	136	N	746	720	1	3	P
1280x768	@ 60 Hz	47.396	59.995	68.25	1440	1280	48	32	P	790	768	3	7	N
1280x768	@ 60 Hz	47.776	59.87	79.5	1664	1280	64	128	N	798	768	3	7	P
1280x768	@ 75 Hz	60.289	74.893	102.25	1696	1280	80	128	N	805	768	3	7	P
1280x800	@ 60 Hz	49.702	59.81	83.5	1680	1280	72	128	N	831	800	3	6	P
1280x800	@ 75 Hz	62.795	74.934	106.5	1696	1280	80	128	N	838	800	3	6	P
1280x960	@ 60 Hz	60	60	108	1800	1280	96	112	P	1000	960	1	3	P
1280x1024	@ 60 Hz	63.981	60.02	108	1688	1280	48	112	P	1066	1024	1	3	P
1280x1024	@ 75 Hz	79.976	75.025	135	1688	1280	16	144	P	1066	1024	1	3	P
1360x768	@ 60 Hz	47.712	60.015	85.5	1792	1360	64	112	P	795	768	3	6	P
1366x768	@ 60 Hz	48	60	72	1500	1366	14	56	P	800	768	1	3	P
1400x1050	@ 60 Hz	64.744	59.948	101	1560	1400	48	32	P	1080	1050	3	4	N
1400x1050	@ 60 RB	65.317	59.978	121.75	1864	1400	88	144	N	1089	1050	3	4	P
1400x1050	@ 75 Hz	82.278	74.867	156	1896	1400	104	144	N	1099	1050	3	4	P
1440x900	@ 60 Hz	55.935	59.887	106.5	1904	1440	80	152	N	934	900	3	6	P
1440x900	@ 75 Hz	70.506	74.847	136.5	1936	1440	96	152	N	942	900	3	6	P
1440x1050	@ 60 Hz	65.234	59.903	125.25	1920	1440	88	152	N	1089	1050	3	10	N
1600x1200	@ 60 Hz	75	60	162	2160	1600	64	192	P	1250	1200	1	3	P
1680x1050	@ 60 Hz	65.402	60.057	146.5	2240	1680	104	176	N	1089	1020	3	6	P
1920x1200	@ 60 RB	74.038	59.95	154	2080	1920	48	32	P	1235	1200	3	6	N
720x480p	@ 59 Hz	31.469	59.94	27	858	720	16	62	N	525	480	9	6	N
720x480p	@ 59 PW	31.469	59.94	27	858	720	16	62	N	525	480	9	6	N
720x576p	@ 50 Hz	31.25	50	27	864	720	12	64	N	625	576	5	5	N
720x576p	@ 50 PW	31.25	50	27	864	720	12	64	N	625	576	5	5	N
1280x720p	@ 50 Hz	37.5	50	74.25	1980	1280	440	40	P	750	720	5	5	P
1280x720p	@ 60 Hz	45	60	74.25	1650	1280	110	40	P	750	720	5	5	P
1280x720p	@ 100 Hz	75	100	148.5	1980	1280	440	40	P	750	720	5	5	P
1280x720p	@ 120 Hz	90	120	148.5	1650	1280	110	40	P	750	720	5	5	P
1920x108p	@ 24 Hz	27	24	74.25	2750	1920	638	44	P	1125	1080	4	5	P
1920x108p	@ 30 Hz	33.75	30	74.25	2200	1920	88	44	P	1125	1080	4	5	P
1920x108p	@ 50 Hz	56.25	50	148.5	2640	1920	528	44	P	1125	1080	4	5	P
1920x108p	@ 60 Hz	67.5	60	148.5	2200	1920	88	44	P	1125	1080	4	5	P

# VIDEO TIMING LIST (VGA)

Resolution		H Freq. (Khz)	V Freq. (Hz)	Pixel Clock (MHz)	H Total Pixel	H Display Pixel	H Front Porch	H Sync Width	H Sync Pol	V Total Lines	V Display Lines	V Front Porch	V Sync Width	V Sync Pol
640x480	@ 60 Hz	31.563	60.119	25.1875	800	640	16	96	N	525	480	10	2	N
640x480	@ 72 Hz	37.861	72.809	31.5	832	640	24	40	N	520	480	9	3	N
640x480	@ 75 Hz	37.5	75	31.5	840	640	16	64	N	500	480	1	3	N
720x400	@ 70 Hz	31.528	70.218	28.3125	900	720	16	108	N	449	400	13	2	P
800x600	@ 56 Hz	35.156	56.25	36	1024	800	24	72	N	625	600	1	2	P
800x600	@ 60 Hz	37.879	60.317	40	1056	800	40	128	N	628	600	1	4	P
800x600	@ 72 Hz	48.077	72.188	50	1040	800	56	120	N	666	600	37	6	P
800x600	@ 75 Hz	46.875	75	49.5	1056	800	16	80	P	625	600	1	3	P
848x480	@ 59 Hz	29.83	59.659	31.5	1056	848	24	80	N	500	480	3	5	P
848x480	@ 60 Hz	31.02	60	33.75	1088	848	16	112	P	517	480	6	8	P
1024x768	@ 60 Hz	48.363	60.004	65	1344	1024	24	136	N	806	768	3	6	N
1024x768	@ 70 Hz	56.476	70.069	75	1328	1024	24	136	N	806	768	3	6	N
1024x768	@ 75 Hz	60.023	75.029	78.75	1312	1024	16	96	N	800	768	1	3	P
1152x864	@ 75 Hz	67.5	75	108	1600	1152	64	128	P	900	864	1	3	P
1280x720	@ 48 Hz	35.539	47.961	58	1632	1280	48	128	N	741	720	1	3	P
1280x768	@ 60 RB	47.396	59.995	68.25	1440	1280	48	32	P	790	768	3	7	N
1280x768	@ 60 Hz	47.776	59.87	79.5	1664	1280	64	128	N	798	768	3	7	P
1280x768	@ 75 Hz	60.289	74.893	102.25	1696	1280	80	128	N	805	768	3	7	P
1280x800	@ 60 Hz	49.702	59.81	83.5	1680	1280	72	128	N	831	800	3	6	P
1280x800	@ 75 Hz	62.795	74.934	106.5	1696	1280	80	128	N	838	800	3	6	P
1280x960	@ 60 Hz	60	60	108	1800	1280	96	112	P	1000	960	1	3	P
1280x1024	@ 60 Hz	63.981	60.02	108	1688	1280	48	112	P	1066	1024	1	3	P
1280x1024	@ 75 Hz	79.976	75.025	135	1688	1280	16	144	P	1066	1024	1	3	P
1360x768	@ 60 Hz	47.712	60.015	85.5	1792	1360	64	112	P	795	768	3	6	P
1400x1050	@ 60 RB	64.744	59.948	101	1560	1400	48	32	P	1080	1050	3	4	N
1400x1050	@ 60 Hz	65.317	59.978	121.75	1864	1400	88	144	N	1089	1050	3	4	P
1400x1050	@ 75 Hz	82.278	74.867	156	1896	1400	104	144	N	1099	1050	3	4	P
1440x900	@ 60 Hz	55.935	59.887	106.5	1904	1440	80	152	N	934	900	3	6	P
1440x1050	@ 60 Hz	65.234	59.903	125.25	1920	1440	88	152	N	1089	1050	3	10	N
1600x1200	@ 60 Hz	75	60	162	2160	1600	64	192	P	1250	1200	1	3	P
1680x1050	@ 60 Hz	65.179	59.852	146	2240	1680	104	176	N	1089	1050	3	6	P
1920x1200	@ 60 RB	74.038	59.95	154	2080	1920	48	32	P	1235	1200	3	6	N

# VIDEO TIMING LIST (DISPLAY PORT)

Resolution		H Freq. (KHz)	V Freq. (Hz)	Pixel Clock (MHz)	H Total Pixel	H Display Pixel	H Front Porch	H Sync Width	H Sync Pol	V Total Lines	V Display Lines	V Front Porch	V Sync Width	V Sync Pol
640x480	@ 60 Hz	31.56	60.12	25.1875	800	640	16	96	N	525	480	10	2	N
640x480	@ 72 Hz	37.86	72.81	31.5	832	640	24	40	N	520	480	9	3	N
640x480	@ 75 Hz	37.5	75	31.5	840	640	16	64	N	500	480	1	3	N
720x400	@ 70 Hz	31.46	70.06	28.3125	900	720	16	108	N	449	400	13	2	P
800x600	@ 56 Hz	35.16	56.25	36	1024	800	24	72	P	625	600	1	2	P
800x600	@ 60 Hz	37.88	60.32	40	1056	800	40	128	P	628	600	1	4	P
800x600	@ 72 Hz	48.08	72.19	50	1040	800	56	120	P	666	600	37	6	P
800x600	@ 75 Hz	46.88	75	49.5	1056	800	16	80	P	625	600	1	3	P
848x480	@ 59 Hz	29.83	59.66	31.5	1056	848	24	80	P	500	480	3	5	P
848x480	@ 60 Hz	31.02	60	33.75	1088	848	16	112	P	517	480	6	8	P
1024x768	@ 60 Hz	48.36	60	65	1344	1024	24	136	N	806	768	3	6	N
1024x768	@ 70 Hz	56.48	70.07	75	1328	1024	24	136	N	806	768	3	6	N
1024x768	@ 75 Hz	60.02	75.03	78.75	1312	1024	16	96	P	800	768	1	3	P
1152x864	@ 75 Hz	67.5	75	108	1600	1152	64	128	P	900	864	1	3	P
1280x720	@ 48 Hz	35.54	47.96	58	1632	1280	48	128	N	741	720	1	3	P
1280x720	@ 50 Hz	36.92	49.82	60.25	1632	1280	48	128	N	741	720	1	3	P
1280x720	@ 60 Hz	44.62	59.81	74.25	1664	1280	56	136	N	746	720	1	3	P
1280x768	@ 60 Hz	47.4	59.99	68.25	1440	1280	48	32	P	790	768	3	7	N
1280x768	@ 60 Hz	47.78	59.87	79.5	1664	1280	64	128	N	798	768	3	7	P
1280x768	@ 75 Hz	60.29	74.89	102.25	1696	1280	80	128	N	805	768	3	7	P
1280x800	@ 60 Hz	49.7	59.81	83.5	1680	1280	72	128	N	831	800	3	6	P
1280x960	@ 60 Hz	60	60	108	1800	1280	96	112	P	1000	960	1	3	P
1280x1024	@ 60 Hz	63.98	60.02	108	1688	1280	48	112	P	1066	1024	1	3	P
1280x1024	@ 75 Hz	79.98	75.02	135	1688	1280	16	144	P	1066	1024	1	3	P
1360x768	@ 60 Hz	47.71	60.02	85.5	1792	1360	64	112	P	795	768	3	6	P
1366x768	@ 60 Hz	48	60	72	1500	1366	14	56	P	800	768	1	3	P
1400x1050	@ 60 Hz	64.74	59.95	101	1560	1400	48	32	P	1080	1050	3	4	N
1400x1050	@ 60 Hz	65.32	59.98	121.75	1864	1400	88	144	N	1089	1050	3	4	P
1400x1050	@ 75 Hz	82.28	74.87	156	1896	1400	104	144	N	1099	1050	3	4	P
1440x900	@ 60 Hz	55.93	59.89	106.5	1904	1440	80	152	N	934	900	3	6	P
1440x900	@ 75 Hz	70.51	74.85	136.5	1936	1440	96	152	N	942	900	3	6	P
1440x1050	@ 60 Hz	65.23	59.9	125.25	1920	1440	88	152	N	1089	1050	3	10	N
1600x1200	@ 60 Hz	75	60	162	2160	1600	64	192	P	1250	1200	1	3	P
1600x1200	@ 65 Hz	81.25	65	175.5	2160	1600	64	192	P	1250	1200	1	3	P
1600x1200	@ 70 Hz	87.5	70	189	2160	1600	64	192	P	1250	1200	1	3	P
1600x1200	@ 75 Hz	93.52	74.81	202	2160	1600	64	192	P	1250	1200	1	3	P
1680x1050	@ 60 Hz	65.18	59.85	146	2240	1680	104	176	N	1089	1050	3	6	P
1920x1200	@ 60 RB	74.04	59.95	154	2080	1920	48	32	P	1235	1200	3	6	N
1920x1200	@ 60 Hz	74.46	59.81	193	2592	1920	136	200	N	1245	1200	3	6	P
2560x1600	@ 60 Hz	98.53	59.86	268	2720	2560	48	32	P	1646	1600	3	6	N
720x480p	@ 59 Hz	31.47	59.94	27	858	720	16	62	N	525	480	9	6	N
720x480p	@ 59 PW	31.47	59.94	27	858	720	16	62	N	525	480	9	6	N
720x576p	@ 50 Hz	31.25	50	27	864	720	12	64	N	625	576	5	5	N
720x576p	@ 50 PW	31.25	50	27	864	720	12	64	N	625	576	5	5	N
1280x720p	@ 50 Hz	37.5	50	74.25	1980	1280	440	40	P	750	720	5	5	P
1280x720p	@ 60 Hz	45	60	74.25	1650	1280	110	40	P	750	720	5	5	P
1280x720p	@ 100 Hz	75	100	148.5	1980	1280	440	40	P	750	720	5	5	P
1280x720p	@ 120 Hz	90	120	148.5	1650	1280	110	40	P	750	720	5	5	P

## VIDEO TIMING LIST (DISPLAY PORT)

1920x1080i	@ 50 Hz	28.13	25	74.25	2640	1920	528	44	P	1125	1080	2	5	P
1920x108p	@ 24 Hz	27	24	74.25	2750	1920	638	44	P	1125	1080	4	5	P
1920x108p	@ 30 Hz	33.75	30	74.25	2200	1920	88	44	P	1125	1080	4	5	P
1920x108p	@ 50 Hz	56.25	50	148.5	2640	1920	528	44	P	1125	1080	4	5	P
1920x108p	@ 60 Hz	67.5	60	148.5	2200	1920	88	44	P	1125	1080	4	5	N

# OSD OPTIONS OVERVIEW

Layer 1	Layer2	Layer3	
Picture	Brightness		
	Contrast		
	Hue		
	Saturation		
	Sharpness		
	Automatic		
Image Setup	Manual	Clock / Phase / Clock	
	Horizontal Position		
	Vertical Position		
	Color	Preset Mode / Custom	
	Input Signal	DVI / HDMI / VGA / Display Port / Component / Composite / S-Video	
	Scaling	Original AR/ Full Screen	
	Output Mode	720x480, 800x600, 1280x800, 1280x1024, 1360x768, 1400x1050, 1600x1200, 1024x768, 1280x768, 1280x720, 1920x1080	
Video Wall	Zoom	Horizontal Zoom / Vertical Zoom	
	Pan	Horizontal Pan / Vertical Pan	
	Overlap	Left / Right / Top / Bottom (Edges) / Reset	
3D Properties	Input Format	Automatic / Side-By-Side / Top-Bottom	
	Output Format	Left Eye Frame / Right Eye Frame	
	1080p 24Hz Output	Enable / Disable	
Options	Information		
	Language	English	
	Reset	Reset All / Reset Video Wall	
	Accessibility	Button Repeat Rate (off, default, slow) / Menu Time Out / Logo Time Out	
	Setting	Mute	
		BOXID	
		Profile	
Network (serial port, Ethernet)			

# PICTURE

**PICTURE** allows you to digitally adjust the brightness, contrast, hue, saturation, and sharpness of the images. An unilluminated icon suggests the function is not available. To enable it, the unit color must be set in custom mode. Go to the 3rd icon in the first layer to change the setting in color: **Image properties -> color -> custom -> save**. Be sure to save your setting. Otherwise, the value will not be set.

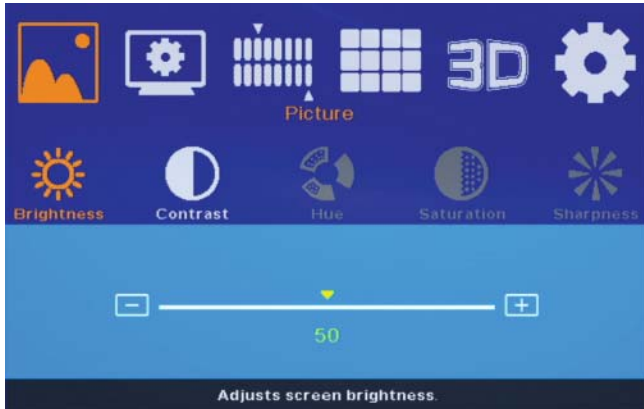

- Layer one, the 1st icon from left
- Choose the icon and use the down arrow key to open the next layer, which has five options: brightness, contrast, hue, saturation, and sharpness
- Hue, saturation, and sharpness, the three icons are illuminated only when signals of AV, S-Video, or component video are present on the scaler



## Brightness

Use arrow key right and left to adjust the value



## Contrast

Use arrow key right and left to adjust the value



## Hue

Use arrow key right and left to adjust the value

Adjustable only when the unit receives valid AV, S-Video, or component video signals.



## Saturation

Use arrow key right and left to adjust the value

Adjustable only when the unit receives valid AV, S-Video, or component video signals.



## Sharpness

Use arrow key right and left to adjust the value

Adjustable only when the unit receives valid AV, S-Video, or component video signals.

# IMAGE SETUP

To enable the **IMAGE SETUP**, a valid VGA signal must be present on the scaler. An illuminated icon indicates the presence of a VGA signal.

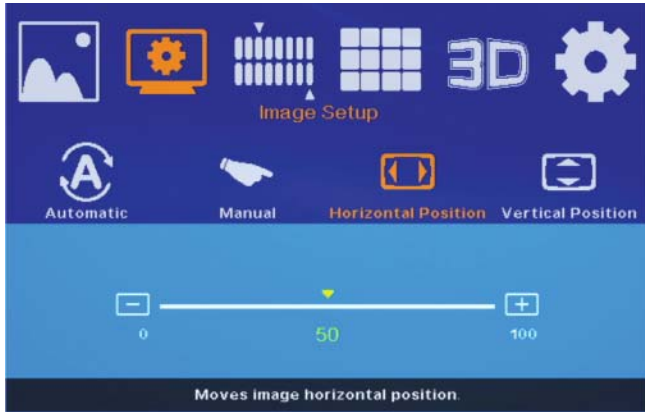

- First layer, the 2nd icon from left
- Choose the icon and use the down arrow key to open the second layer, which has four options: automatic, manual, horizontal position, vertical position



## **Automatic**

SB-3879 reads the Input signal and automatically sets the optimal value for the Output.



## **Manual**

Clock / Phase / Save



## **Horizontal Position**

Move the image to right or left.



## **Vertical Position**

Move the image up or down.



# IMAGE PROPERTIES

**IMAGE PROPERTIES** allow you to change Color, select Input Signal, adjust scaling, and change Output Resolution. Resolutions not listed on the front panel button can be selected here, under the output mode.



- Layer one, the 3rd icon from left
- Choose the icon and use the down arrow key to open up the second layer, which has four options: color, input signal, scaling, output mode
- Setting the color in custom mode can enable the PICTURE function (layer one, the 1st icon from left).



## Color

Preset Mode: Standard, RGB, warm, cold  
Custom: Red, Green, Blue, Save



## Input Signal

DVI, HDMI, VGA, Display Port, Component, Composite Video, S-Video



## Scaling

Original AR, Full Screen



## Output Mode

Select one desired output resolution from the following 11 choices.

OTHERS	720x480, 800x600, 1280x800, 1280x1024, 1360x768, 1400x1050, 1600x1200, 1920x1200
XGA	1024x768
WXGA	1280x768
720p	1280x720
1080p	1920x1080

When the front panel button OTHERS is pressed, the scaler will automatically apply the resolution 1360x768.

Users may continue pressing OTHERS to cycle through the following four resolutions:

**1360x768 -> 1280x1024 -> 1600x1200 -> 1920x1200**

# TV WALL

SB-3879 scaler is able to send divided images on multiple display devices and build a video wall, be it a wall of size 1x2, 2x2, or 10x10. Maximally, the scaler can make possible a video wall of 15 by 15 screens. Note that an SB-3879 is required for each output. Users may arrange the position and adjust the size of each image block under the TV WALL function.



- Layer one, the 3rd icon from the left
- Choose the TV wall icon, use the down arrow key to open the next layer, which has three options: zoom, pan, overlap

**ZOOM:** Use right / left key to adjust the value of the parameter:  
**Horizontal zoom:** enlarge the image on the left and right ends.  
**Vertical zoom:** enlarge the image upwardly and downwardly.

**PAN:** Arrange the relative position of the image in the TV wall. First calculate the size of the TV wall: the number of displays horizontally and vertically connected. Then, assign numbers to indicate relative position. Take the following two TV walls for example.

**3x2 TV wall (Horizontal: 3 ; Vertical: 2)**

**Display No.4 should be assigned:**

Horizontal Zoom = 1

Vertical Zoom = 2

**Display No.5 should be assigned:**

Horizontal Zoom = 2

Vertical Zoom = 2

1	2	3
4	5	6

**3x3 TV wall (Horizontal: 3 ; Vertical: 3)**

**Display No.9 should be assigned:**

Horizontal Zoom = 3

Vertical Zoom = 3

1	2	3
4	5	6
7	8	9

**OVERLAP:** Align the overlapping images for visual continuum. Move the image up, down or to left, right by adjusting the parameters of the top edge, bottom edge, left edge, and right edge. To return to the original setting, press RESET.

# OPTIONS

**OPTIONS** allows you to check the connection status, change menu language, return to factory default, save setting, and make adjustments to the setting of the OSD menu .



- Layer one, the 6th icon from left
- Press the down arrow key to open up the second layer, which has five options: info, language, reset, accessibility, setting

**INFO:** Check the connection status of Input/Output ports, the model name, the connection status of RS-232/Ethernet ports, and firmware version.

**LANGUAGE:** Arrange the relative position of the image in the TV wall. First calculate the size of the TV wall: the number of displays horizontally and vertically connected. Then, assign numbers to indicate relative position. Take the following two TV walls for example.

**RESET:** Return to factory default setting.

**Reset all:** reset all options.

**Reset video wall:** reset all the options relating to video wall function only.

### **Accessibility:**

**Button repeat rate:** Adjust the unit response time when MENU button is pressed.

**Off:** Press MENU button, and the MENU shows up/disappears once.

**Default:** Return to the factory default setting.

**Slow:** Press MENU button and hold on for longer seconds, the unit will take more time than default to respond.

**Menu time out:** Adjust the length of time OSD menu stays on screen.

**On:** The OSD menu will disappear after a period of time. You can lengthen or shorten the menu display time.

**Off:** Stop the OSD menu from disappearing automatically. When the function is turned off, the OSD menu will not disappear until MENU button is pressed again.

**Logo time out:** Adjust the length of time the logo stays on screen when the unit is turned on.

### **SETTING:**

**Mute:** Stop playing sounds.

**BOX 10:** Check the 10 of the unit.

**Profile:** Save and reload the settings. The unit can memorize a total of 5 different settings.

**Network:** Serial Port, Ethernet

# LIMITED WARRANTY

PLEASE READ THE FOLLOWING TERMS AND CONDITIONS CAREFULLY BEFORE USING THIS HARDWARE, COMPONENTS AND SOFTWARE PROVIDED BY, THROUGH OR UNDER SHINYBOWUSA, INC (COLLECTIVELY, THE "PRODUCT"). By using installing or using the Product, you unconditionally signify your agreement to these Terms and Conditions. If you do not agree to these Terms and Conditions, do not use the Product and return the Product to SHINYBOWUSA, Inc. at the return address set forth on the Product's packing label at your expense. SHINYBOWUSA, Inc. may modify these Terms and Conditions at anytime, without notice to you.

## **RESTRICTIONS ON USE OF THE PRODUCT**

It is your responsibility to read and understand the installation and operation instructions, both verbal and in writing, provided to you with respect to the Product. You are authorized to use the Product solely in connection with such instructions. Any use of the Product not in accordance with such instructions shall void any warranty pertaining to the Product. Any and all damages that may occur in the use of the Product that is not strictly in accordance with such instructions shall be borne by you and you agree to indemnify and hold harmless SHINYBOWUSA, Inc. from and against any such damage.

The Product is protected by certain intellectual property rights owned by or licensed to SHINYBOWUSA. Any intellectual property rights pertaining to the Product are licensed to you by SHINYBOWUSA, Inc. and/or its affiliates, including any manufacturers or distributors of the Product (collectively, "SHINYBOWUSA") for your personal use only, provided that you do not change or delete any proprietary notices that may be provided with respect to the Product.

The Product is sold to you and any use of any associated intellectual property is deemed to be licensed to you by SHINYBOWUSA for your personal use only. SHINYBOWUSA does not transfer either the title or the intellectual property rights to the Product and SHINYBOWUSA retains full and complete title to the intellectual property rights therein. All trademarks and logos are owned by SHINYBOWUSA or its licensors and providers of the Product, and you may not copy or use them in any manner without the prior written consent of SHINYBOWUSA, which consent may be withheld at the sole discretion of SHINYBOWUSA.

The functionality and usability of the Product is controlled by SHINYBOWUSA, Inc. from its offices within the State of Texas, United States of America. SHINYBOWUSA makes no representation that materials pertaining to the Product are appropriate or available for use in other locations other than the shipping address you provided with respect thereto. You are advised that the Product may be subject to U.S. export controls.

Disclaimers and Limitation of Liability

SHINYBOWUSA may change or modify the Product at any time, from time to time.

THE PRODUCT IS PROVIDED "AS IS" AND WITHOUT WARRANTIES OF ANY KIND EITHER EXPRESS OR IMPLIED. SHINYBOWUSA DOES NOT WARRANT OR MAKE ANY REPRESENTATIONS REGARDING THE USE OR THE RESULTS OF THE USE OF THE PRODUCT'S CORRECTNESS, ACCURACY, RELIABILITY, OR OTHERWISE.

SHINYBOWUSA has no duty or policy to update any information or statements pertaining to the Product and, therefore, such information or statements should not be relied upon as being current as of the date you use the Product. Moreover, any portion of the materials pertaining to the Product may include technical inaccuracies or typographical errors. Changes may be made from time to time without notice with respect to the Product.

TO THE FULLEST EXTENT PERMISSIBLE PURSUANT TO APPLICABLE LAW, SHINYBOWUSA DISCLAIMS ALL WARRANTIES, EXPRESS OR IMPLIED, INCLUDING, BUT NOT LIMITED TO IMPLIED WARRANTIES OF MERCHANTABILITY, FITNESS FOR A PARTICULAR PURPOSE AND NON-INFRINGEMENT. SHINYBOWUSA DOES NOT WARRANT THE ACCURACY, COMPLETENESS OR USEFULNESS OF ANY INFORMATION WITH RESPECT TO THE PRODUCT. SHINYBOWUSA DOES NOT WARRANT THAT THE FUNCTIONS PERTAINING TO THE PRODUCT WILL BE ERROR-FREE, THAT DEFECTS WITH RESPECT TO THE PRODUCT WILL BE CORRECTED, OR THAT THE MATERIALS PERTAINING THERETO ARE FREE OF DEFECTS OR OTHER HARMFUL COMPONENTS. SHINYBOWUSA WILL USE ITS REASONABLE EFFORTS TO CORRECT ANY DEFECTS IN THE PRODUCT UPON TIMELY WRITTEN NOTICE FROM YOU NOT TO EXCEED 10 BUSINESS DAYS AFTER RECEIPT BY YOU OF THE PRODUCT, BUT YOU (AND NOT SHINYBOWUSA) ASSUME THE ENTIRE COST OF ALL NECESSARY SERVICING, REPAIR AND CORRECTION THAT WAS CAUSED BY YOU UNLESS OTHERWISE AGREED TO IN A SEPARATE WRITING BY SHINYBOWUSA.

UNDER NO CIRCUMSTANCES, INCLUDING, BUT NOT LIMITED TO, NEGLIGENCE, SHALL SHINYBOWUSA BE LIABLE FOR ANY SPECIAL OR CONSEQUENTIAL DAMAGES THAT RESULT FROM THE USE OF, OR THE INABILITY TO USE THE PRODUCT IN ACCORDANCE WITH ITS SPECIFICATIONS, EVEN IF SHINYBOWUSA OR ITS REPRESENTATIVES HAVE BEEN ADVISED OF THE POSSIBILITY OF SUCH DAMAGES. IN NO EVENT SHALL SHINYBOWUSA'S TOTAL LIABILITY TO YOU FROM ALL DAMAGES, LOSSES, AND CAUSES OF ACTION (WHETHER IN CONTRACT, OR OTHERWISE) EXCEED THE AMOUNT YOU PAID TO SHINYBOWUSA, IF ANY, FOR THE PRODUCT.

END OF DOCUMENT

# SHINYBOW™ USA

MULTIMEDIA AUDIO AND VISUAL

---