

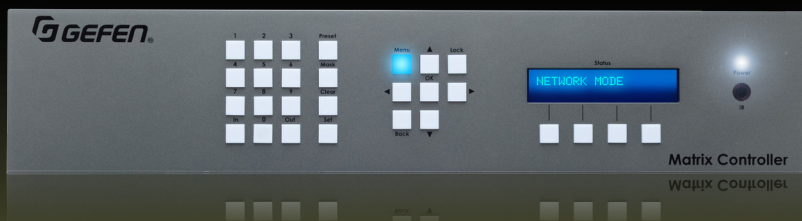

Matrix Controller

EXT-CU-LAN

User Manual



Release A5

Important Safety Instructions

1. Read these instructions.
2. Keep these instructions.
3. Heed all warnings.
4. Follow all instructions.
5. Do not use this product near water.
6. Clean only with a dry cloth.
7. Do not block any ventilation openings. Install in accordance with the manufacturer's instructions.
8. Do not install or place this product near any heat sources such as radiators, heat registers, stoves, or other apparatus (including amplifiers) that produce heat.
9. Do not defeat the safety purpose of the polarized or grounding-type plug. A polarized plug has two blades with one wider than the other. A grounding type plug has two blades and a third grounding prong. The wide blade or the third prong are provided for your safety. If the provided plug does not fit into your outlet, consult an electrician for replacement of the obsolete outlet.
10. Protect the power cord from being walked on or pinched particularly at plugs, convenience receptacles, and the point where they exit from the apparatus.
11. Only use attachments/accessories specified by the manufacturer.
12. To reduce the risk of electric shock and/or damage to this product, never handle or touch this unit or power cord if your hands are wet or damp. Do not expose this product to rain or moisture.
13. Unplug this apparatus during lightning storms or when unused for long periods of time.
14. Refer all servicing to qualified service personnel. Servicing is required when the apparatus has been damaged in any way, such as power-supply cord or plug is damaged, liquid has been spilled or objects have fallen into the apparatus, the apparatus has been exposed to rain or moisture, does not operate normally, or has been dropped.
15. Batteries that may be included with this product and/or accessories should never be exposed to open flame or excessive heat. Always dispose of used batteries according to the instructions.

Warranty Information

Gefen warrants the equipment it manufactures to be free from defects in material and workmanship.

If equipment fails because of such defects and Gefen is notified within two (2) years from the date of shipment, Gefen will, at its option, repair or replace the equipment, provided that the equipment has not been subjected to mechanical, electrical, or other abuse or modifications. Equipment that fails under conditions other than those covered will be repaired at the current price of parts and labor in effect at the time of repair. Such repairs are warranted for ninety (90) days from the day of reshipment to the Buyer.

This warranty is in lieu of all other warranties expressed or implied, including without limitation, any implied warranty or merchantability or fitness for any particular purpose, all of which are expressly disclaimed.

1. Proof of sale may be required in order to claim warranty.
2. Customers outside the US are responsible for shipping charges to and from Gefen.
3. Copper cables are limited to a 30 day warranty and cables must be in their original condition.

The information in this manual has been carefully checked and is believed to be accurate. However, Gefen assumes no responsibility for any inaccuracies that may be contained in this manual. In no event will Gefen be liable for direct, indirect, special, incidental, or consequential damages resulting from any defect or omission in this manual, even if advised of the possibility of such damages. The technical information contained herein regarding the features and specifications is subject to change without notice.

For the latest warranty coverage information, refer to the Warranty and Return Policy under the Support section of the Gefen Web site at www.gefen.com.

Technical Support

(818) 772-9100 (800) 545-6900
8:00 AM to 5:00 PM Monday - Friday, Pacific Time

Fax

(818) 772-9120

Email

support@gefen.com

Web

<http://www.gefen.com>

Mailing Address

Gefen, LLC
c/o Customer Service
20600 Nordhoff St.
Chatsworth, CA 91311

Product Registration

Register your product here: <http://www.gefen.com/kvm/Registry/Registration.jsp>

- You should have a managed gigabit switch with 8K (or greater) jumbo-frame capability.
- The Matrix Controller has been tested with both Cisco and NetGear switches. However, performance and results may vary between depending upon the switch that is used and your network.
- The “discovery” feature, used by the Matrix Controller, relies on a proprietary network broadcast protocol that is used for identification of Gefen KVM over IP products. Broadcast packets and access using ports 53334 and 53335 is required for this feature to work.
- The Gefen Video-over-IP product line is compatible with a wide variety of data switches:
 - ▶ For simple installations, the **Netgear GS724T / GS748T / GS748TPS** (PoE version) are low-cost 24-port or 48-port Gigabit Smart Switches that meet all necessary requirements. They have two SFP ports that can be equipped with fiber SFP modules for greater distances.
 - ▶ For cascaded or extended switch architecture, more than 1 Gigabit bandwidth may be required between switches. For these situations, the **Netgear PROSAFE GS728TXS Gigabit Stackable Smart Switch** offers four 10-Gigabit SFP uplink ports for expanded bandwidth between switches.
 - ▶ Other Gigabit managed switches, such as the **Cisco Small Business SG300** or **SG500X** (“X” indicates 10G SFP uplink port) switches may also be used. However, the configuration will be up to the user.
- In order to properly manage the video traffic, both Jumbo Frames and IGMP Snooping must be *enabled*.

Netgear GS7xxT-series switches:

1. Login to the switch with a Web browser.
2. Go to the **Switching** tab and select **Ports > Port Configuration**.
3. Check the **All** checkbox, and set **Maximum Frame Size** to 9216.
4. Click **Apply** to save the settings.
5. Go to **Multicast > IGMP Snooping > IGMP Snooping Configuration**.
6. Enable **IGMP Snooping Status**.
7. Disable **Validate IGMP IP Header**.
8. Click **Apply** to save the settings.
9. Go to **IGMP Snooping VLAN Configuration**.
10. Enter 1 under **Vlan ID**.
11. Enable **Fast Leave Admin Mode** and **Query Mode**.
12. Click **Apply** to save the settings.

Cisco SG300 or SG500-series switches:

1. Login to the switch with a Web browser.
 2. Go to **Admin > Port Management > Port Settings**.
 3. Click **Enable Jumbo Frames**.
 4. Click **Apply** to save the settings.
 5. Click **Multicast > Properties**.
 6. Enable **Bridge Multicast Filtering**.
 7. Click **Apply** to save the settings.
 8. Go to **Multicast > IGMP Snooping**.
 9. Enable **IGMP Snooping**.
 10. Click **Apply** to save the settings.
- The [Gefen Syner-G Software Suite](#) is a free downloadable application from Gefen that provides network configuration assistance and automatic download and installation firmware upgrades for this product. Always make sure that the Matrix Controller is running the latest firmware.

Matrix Controller is a trademark of Gefen, LLC.

© 2015 Gefen, LLC. All Rights Reserved. All trademarks are the property of their respective owners.

Gefen, LLC reserves the right to make changes in the hardware, packaging, and any accompanying documentation without prior written notice.



This product uses UL or CE listed power supplies.

This product uses software that is subject to open source licenses, including one or more of the General Public License Version 2 and Version 2.1, Lesser General Public License Version 2.1 and Version 3, BSD, and BSD-style licenses. Distribution and use of this product is subject to the license terms and limitations of liability provided in those licenses. Specific license terms and Copyright Notifications are provided in the source code.

For three years from date of activation of this product, any party may request, and we will supply, for software covered by an applicable license (e.g. GPL or LGPL), a complete machine-readable copy of the corresponding open source code on a medium customarily used for software interchange. The following software and libraries are included with this product and subject to their respective open source licenses:

- Linux

Features

- Detects, configures, and controls all Gefen Video and KVM over IP products
- Built-in web server allows access from any web-enabled device, including phones, tablets, and PCs
- Two Ethernet ports with independent IP and MAC Addresses allow segregation of Video/KVM LAN and control LAN, and help provide separate security layers for administrators and end-users
- Seamless integration with Gefen Syner-G™ software allows for quick installation and configuration on a network
- Automatic assignment of IP addresses for all Gefen Video and KVM over IP devices on a network
- Front panel control push-buttons/display, handheld IR remote, and web server interface allow easy and convenient end-user operation
- Automation control system interface via Telnet and UDP
- POE (Power Over Ethernet) on LAN 1 port eliminates the need for an external power supply
- Password-protected independent user and administrative access
- Easy to read 2 line/20 characters per line Liquid Crystal Display
- System Configuration Upload/Download function
- Plug-and-Play installation with little to no set-up
- Locking power supply connector
- 2U tall rack-mountable enclosure, detachable rack ears included
- Slanted front panel for ergonomic push-button access and display visibility when placed on a table

Packing List

The Matrix Controller ships with the items listed below. If any of these items are not present in the box when you first open it, immediately contact your dealer or Gefen.

- 1 x Matrix Controller
- 1 x IR Remote Control Unit
- 1 x 5V DC Power Supply
- 1 x Rack Ears (set)
- 6 x Rubber Feet
- 4 x Machine Screws
- 1 x Quick-Start Guide

1 Getting Started

Introduction.....	2
Panel Layout.....	2
IR Remote Control.....	5
Installing the Batteries.....	7
Setting the IR Channel.....	8
Installation.....	9
Combined Mode.....	9
Separate Mode.....	13
Configuring Slave Units.....	16
Device Configuration.....	20

2 Basic Operation

Groups, Users, and Members.....	28
Users.....	30
Creating Users.....	30
User Access Level Summary.....	32
Deleting Users.....	33
Editing Users.....	34
Groups.....	36
The Default Group.....	36
Creating Groups.....	38
Deleting Groups.....	40
Editing Groups.....	41
Adding Inputs and Outputs.....	42
Removing Inputs and Outputs.....	45
Adding Members.....	47
Removing Members.....	49
Routing.....	51
Inputs to Outputs.....	51
Outputs to Inputs.....	53
Blocking Inputs.....	54
Masking Outputs.....	56
Matrix View Mode.....	58
Using Presets.....	63
Creating User Presets.....	63
Creating Group Presets.....	66
Creating Quick Presets.....	70
Editing Quick Presets.....	72
Using Quick Presets.....	74
Menu System.....	75
Accessing the Menu System.....	75
Routing Inputs to Outputs.....	78
Routing Outputs to Inputs.....	84
Adding Outputs.....	89

Masking an Output	91
Selecting Presets	93
Setting the Network Mode	97
Control IP Settings	100
Video IP Settings	107
Telnet / TCP Settings	113
UDP Settings	118
Discovery Settings	124
Setting the IR Channel for the Matrix Controller	127
Front Panel Lockout	129
Front Panel Timeout	131
Resetting the Matrix Controller	133
Rebooting the Matrix Controller	137
Locking / Unlocking the Matrix Controller	140
Web Interface	141
Login Screen	141
Main	142
Groups > Inputs / Outputs	147
Groups > Members	148
Users	151
I/O	152
Network > IP	157
Network > TCP	159
Network > UDP	160
Network > Discovery	161
System > Basic Settings	163
System > Slave Config	165

3 Advanced Operation

Commands	170
----------------	-----

4 Appendix

Firmware Update Procedure	218
Updating the Matrix Controller	218
Updating Sender and Receiver Units	221
Menu System Summary	229
Specifications	232
Index	233

This page left intentionally blank.

This page left intentionally blank.

Matrix Controller

1

Getting Started

Panel Layout

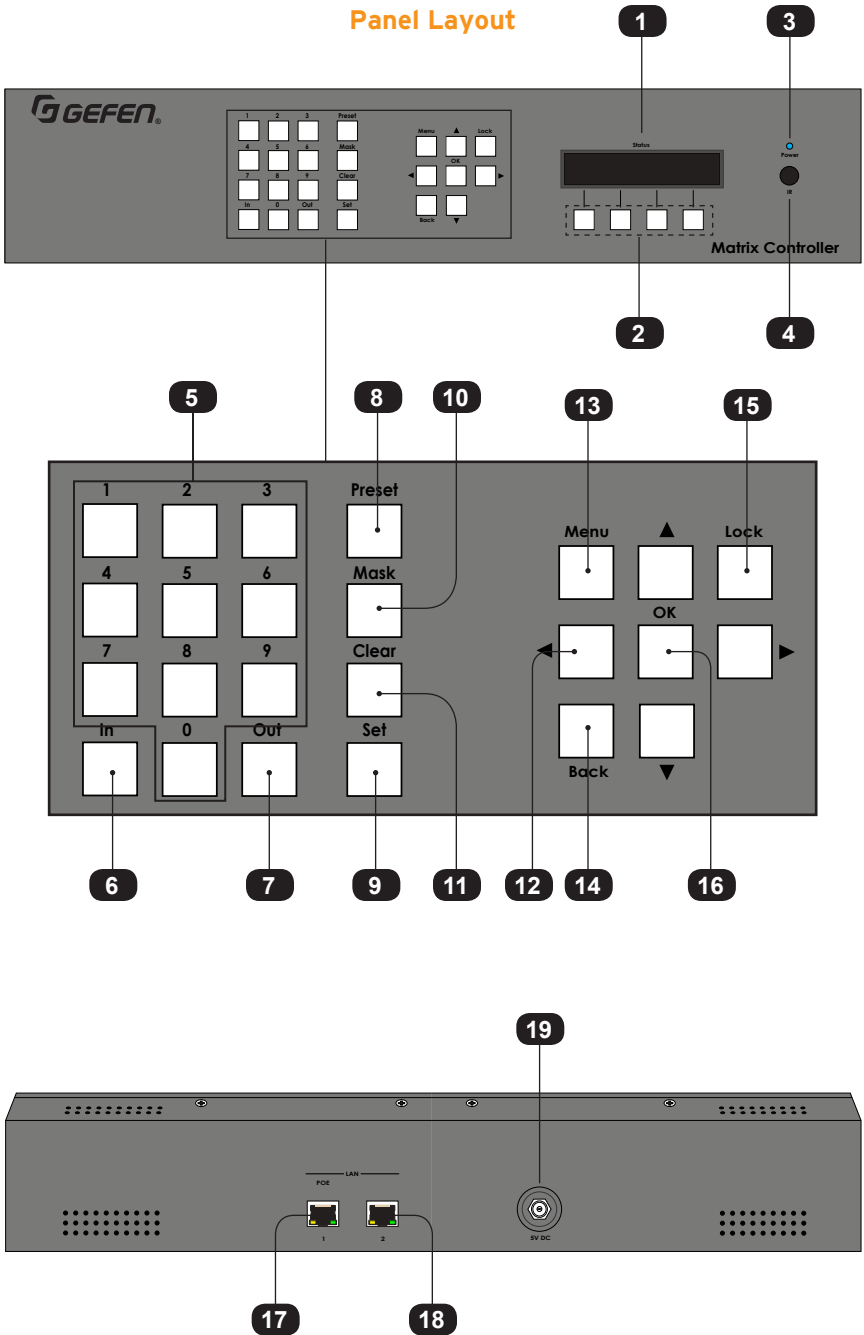

ID	Name	Description
1	LCM display	Provides feedback and status of the Matrix Controller during various operations.
2	Soft buttons	Each of these buttons will have a different function, depending upon the read-out in the LCM display.
3	Power	This LED indicator will glow solid blue when the Matrix Controller is powered.
4	IR sensor	This IR sensor receives signals from the included IR remote control.
5	Numeric keypad (0- 9)	Use this keypad to enter numerical values.
6	In	Press to select the desired input.
7	Out	Press to select the desired output.
8	Preset	Press this button to select the desired preset. Define presets in the Web interface. See Using Presets (page 63) .
9	Set	Press this button to accept the current entry or setting within the LCM display. This button has the same function as the OK button.
10	Mask	Press this button to mask an output. See Masking an Output (page 91) for more information.
11	Clear	Press this button to clear the current entry, when using the numerical keypad.
12	Arrow buttons	Press these buttons to move the cursor within each setting or to select the desired menu system.
13	Menu	Press this button to enter the Menu System. See Accessing the Menu System (page 75) for more information.

ID	Name	Description
14	Back	Press this button to return to a previous screen in the LCM display.
15	Lock	Press this button to lock the Matrix Controller. When the Matrix Controller is locked, the enter passcode screen will be shown in the LCM display.
16	OK	Press this button to accept the current entry or setting within the LCM display.
17	LAN 1 (POE)	Connect an Ethernet cable from this port to the LAN. See Combined Mode (page 9) and/or Separate Mode (page 13) .
18	LAN 2	Connect an Ethernet cable from this port to a managed switch. This port is only used if the video devices are on a separate switch. See Separate Mode (page 13) for more information.
19	5V DC	Connect the included 5V DC power supply to this power receptacle. Connect the power cord to an available electrical outlet. NOTE: If the LAN 1 port is connected to a PoE Switch (e.g Netgear ProSafe GS748TPS), then a separate power connection is not required.

IR Remote Control

Each of the buttons on the IR Remote Control are identical in functionality to those of the buttons on the front panel.

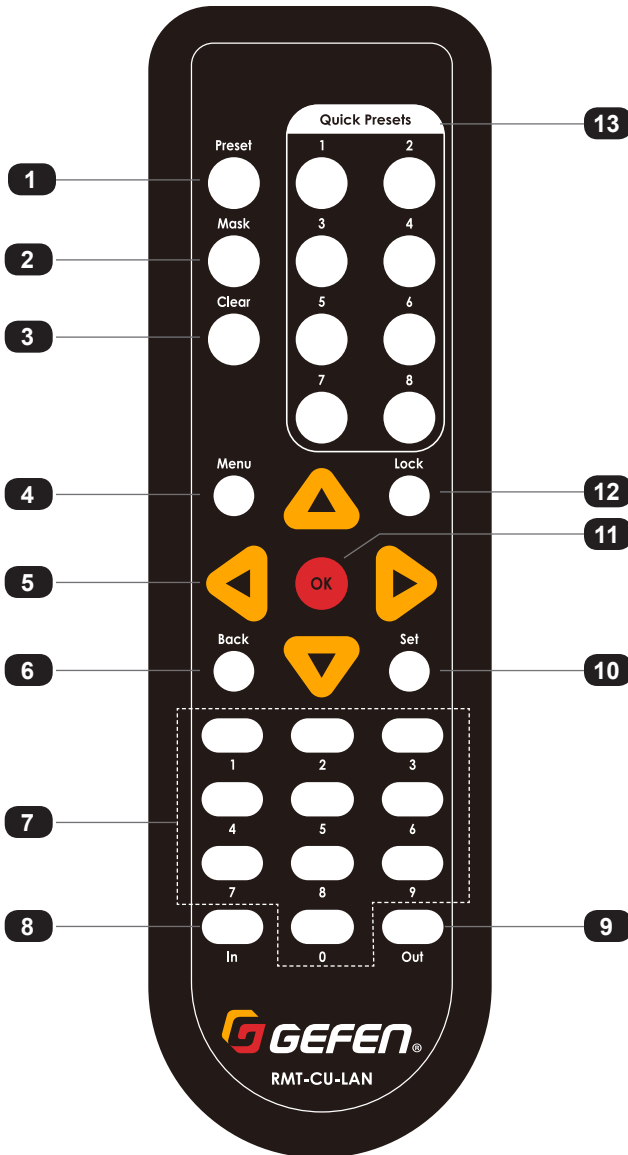

ID	Name	Description
1	Preset	Press this button to select a preset.
2	Mask	Press this button to mask an output. See Masking an Output (page 91) for more information.
3	Clear	Press this button to clear the current entry.
4	Menu	Press this button to access the menu system.
5	Arrow Buttons	Press these buttons to move the cursor within each setting or to select the desired menu system.
6	Back	Press this button to return to the previous screen.
7	Numeric Keypad (0 - 9)	Use these buttons to enter the desired values for each setting.
8	In	Press this button to specify an input.
9	Out	Press this button to specify an output.
10	Set	Press this button to accept the current value.
11	OK	Press this button to accept the current settings.
12	Lock	Press this button to lock the front panel.
13	Quick Presets	Press these buttons to instantly recall the desired preset. See Creating Quick Presets (page 70) for more information.
14	IR Sensor (front of remote)	Point the IR sensor at the front panel of the Matrix Controller.

Installing the Batteries

1. Remove the back cover the IR remote control unit.
2. Insert two 1.5V AAA-type batteries, as shown, within the battery compartment.

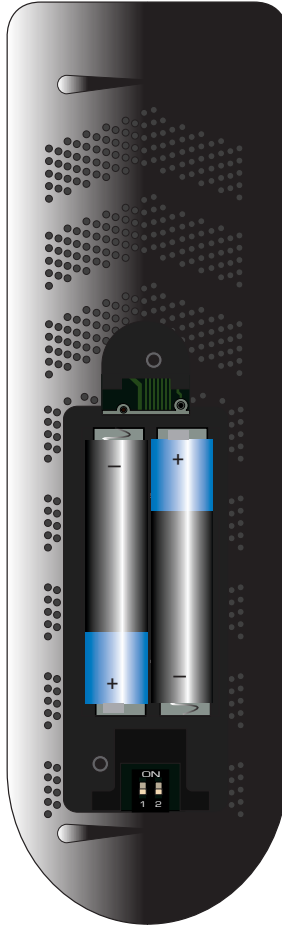

3. Replace the back cover.



Warning!

Risk of explosion if battery is replaced by an incorrect type. Dispose of used batteries according to the instructions.

Setting the IR Channel



Information

In order for the IR remote control to function properly, both the Matrix Controller and the IR remote control must be set to the same IR channel.

In order for the included IR remote control to communicate with the Matrix Controller, the IR remote control must be set to the same channel as the matrix. See [Setting the IR Channel for the Matrix Controller](#) (page 127) for more information.

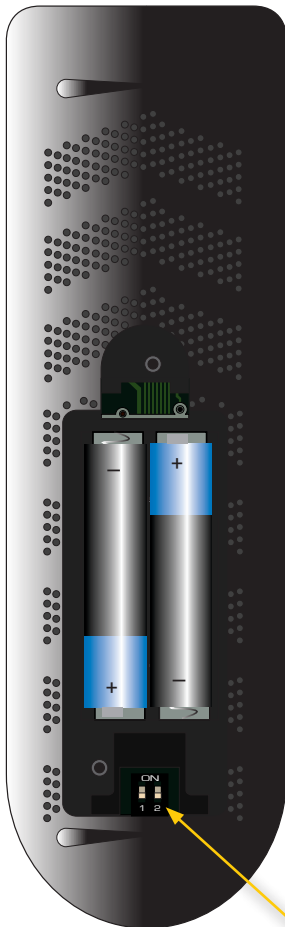

Channel 0 (default):



DIP1 = OFF
DIP2 = OFF

Channel 1:



DIP1 = ON
DIP2 = OFF

Channel 2:



DIP1 = OFF
DIP2 = ON

Channel 3:

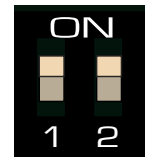

DIP1 = ON
DIP2 = ON

DIP switches

The Matrix Controller is designed to manage and control the Gefen family of Video and KVM over IP products in a virtual matrix environment. The Matrix Controller provides two methods of network control:

► **Combined mode**

This mode is used when the Matrix Controller is connected to the same switch as the KVM over IP products. This is the default setting.

When using *combined mode*, network performance may be degraded because of the large amount of bandwidth required to support video signals on the same switch. To solve this issue, *separate mode* can be used. To use *separate mode*, an independent managed switch must be installed to support the Gefen KVM over IP products. See [Separate Mode \(page 13\)](#) for more information.

► **Separate mode**

This mode is used when the KVM over IP products are connected to a separate (dedicated) managed switch.

Combined Mode

1. Connect a shielded CAT-5e (or better) cable from each of the Gefen KVM over IP units to a managed switch. Refer to the User Manual(s) for the Gefen KVM over IP units to obtain the network requirements.

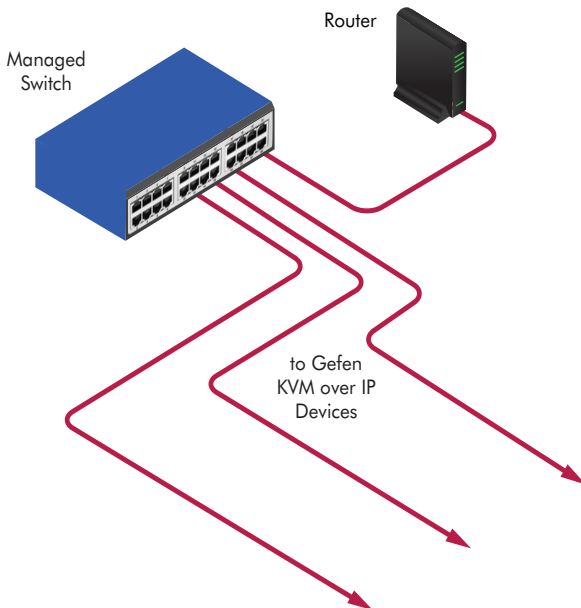

2. Connect a shielded CAT-5e (or better) cable from the **LAN 1** port on the Matrix Controller to the same network where the Gefen KVM over IP units are connected.
3. Connect the included power supply to the **5V DC** power receptacle on the rear panel of the Matrix Controller. Connect the power cord to an available electrical outlet.

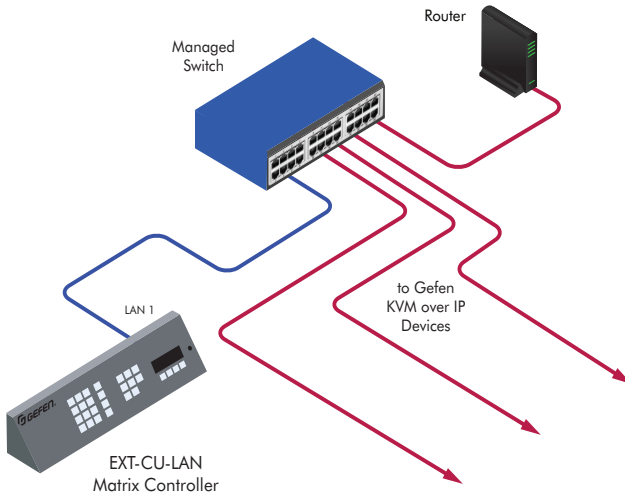

4. The Matrix Controller will begin the initialization process. This may take several seconds.

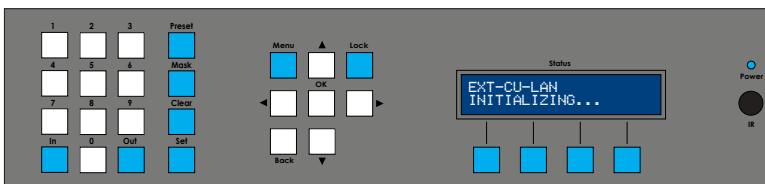

5. After the Matrix Controller has completed the initialization process, the following message will appear in the LCM display on the front panel. The default passcode used to access the front panel is 123456.

To change this passcode, see [Editing Users](#) (page 34).

ENTER PASSCODE:

Entering the correct passcode will allow us to control routing and other functions using the front panel. However, before we can use the front panel controls, we must configure the Matrix Controller through the built-in Web interface. The front panel controls will be covered in the section [Accessing the Menu System \(page 75\)](#).

6. Connect a computer to the same network as the Matrix Controller, as shown below. Set the computer's IP address to `192.168.1.xxx`, where `xxx` is a value between 1 and 254.



Important

Do not use the IP address `192.168.1.74` because this is the IP address of the Matrix Controller. If the current network configuration is already within this range, make sure that the IP address `192.168.1.74` is not assigned to another device in order to avoid conflicts.

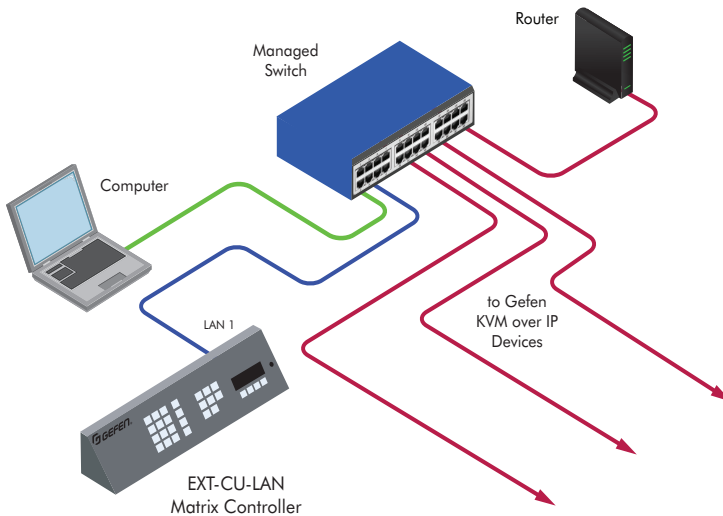

7. Set the subnet mask to `255.255.255.0`.
8. Open a Web browser and enter the following address: `192.168.1.74`.
9. The login page to the Matrix Controller will be displayed.

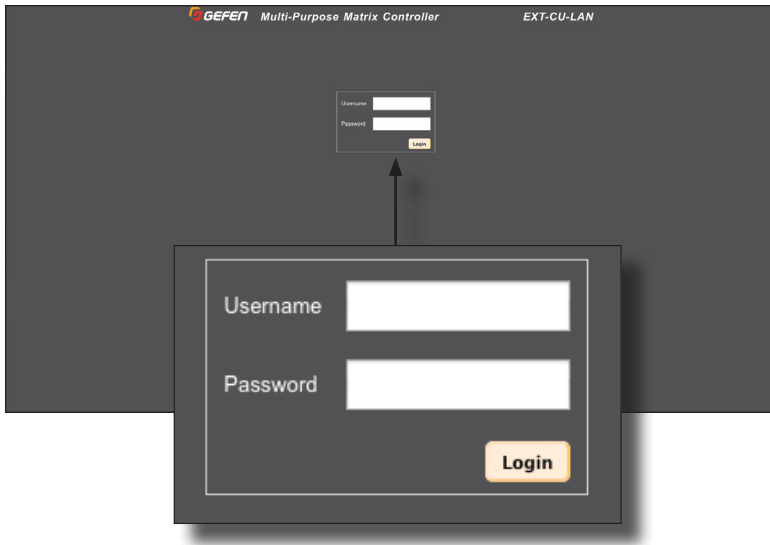

10. Type `admin` (case-sensitive) in both the **Username** and **Password** fields, then click the **Login** button.
11. To continue, skip to [Device Configuration](#) (page 20).

Separate Mode

This mode is used when the KVM over IP products are connected to a separate (dedicated) managed switch. Two CAT-5e (or better) cables will be required to connect the Matrix Controller. If a single switch will be connecting Gefen KVM over IP products in addition to your other network devices, then refer to [Combined Mode \(page 9\)](#).

1. Connect a shielded CAT-5e (or better) cable from each of the Gefen KVM over IP units to a managed switch. Refer to the User Manual(s) for the Gefen KVM over IP units to obtain the network requirements..



Information

The Matrix Controller has been tested with both Cisco and NetGear switches. However, performance and results may vary between depending upon the switch that is used and your network.

2. Connect a CAT-5e (or better) cable from the **LAN 1** port on the Matrix Controller to the network switch.
3. Connect a secondary CAT-5e (or better) cable from the **LAN 2** port on the Matrix Controller to the dedicated AV/KVM gigabit switch.

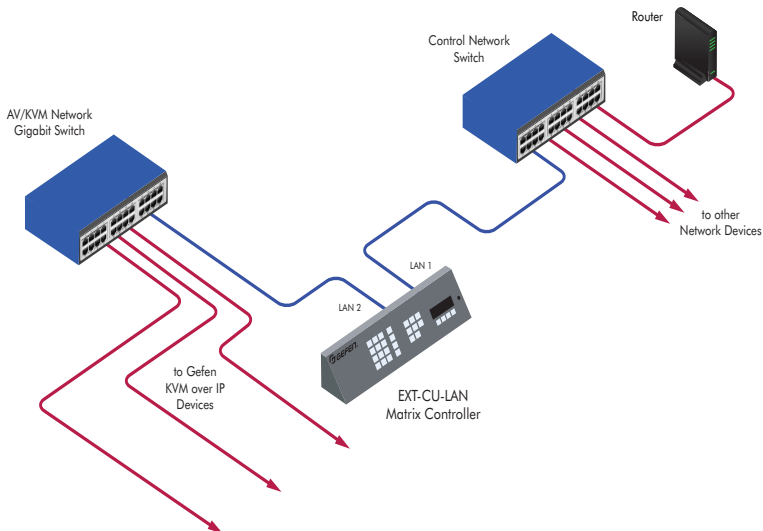

4. Connect the included power supply to the **5V DC** power receptacle on the rear panel of the Matrix Controller. Connect the power cord to an available electrical outlet.

- The Matrix Controller will begin the initialization process. This may take several seconds.

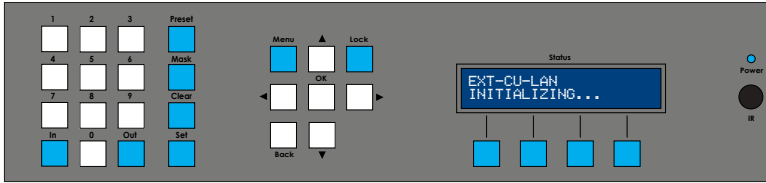

- After the Matrix Controller has completed the initialization process, the following message will appear in the LCM display on the front panel. The default passcode used to access the front panel is 123456.

To change this passcode, see [Editing Users \(page 34\)](#).

ENTER PASSCODE:

Entering the correct passcode will allow us to control routing and other functions using the front panel. Before we can use the front panel controls, we must configure the Matrix Controller through the built-in Web interface. The front panel controls will be covered in another section.

- Connect a computer to the same network as the Matrix Controller, as shown below. Set the computer's IP address to 192.168.1.xxx, where xxx is a value between 1 and 254.

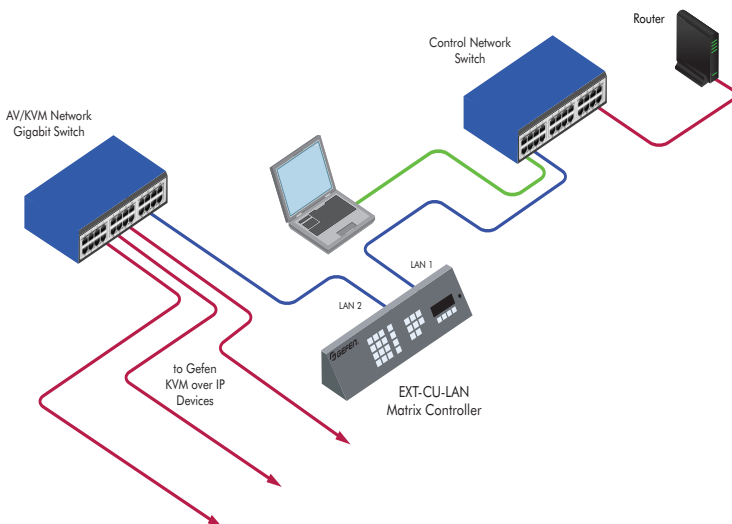



Important

Do not use the IP address 192.168.1.74 because this is the IP address of the Matrix Controller. If the current network configuration is already within this range, make sure that the IP address 192.168.1.74 is not assigned to another device in order to avoid conflicts.

8. Set the subnet mask to 255.255.255.0.
9. Open a Web browser and enter the following address: 192.168.1.74.
10. The login page to the Matrix Controller will be displayed.

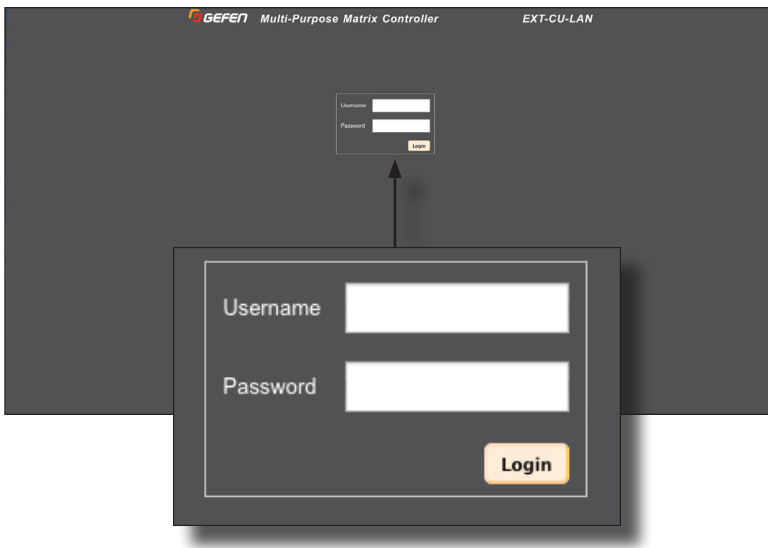

10. Type `admin` (case-sensitive) in both the **Username** and **Password** fields, then click the **Login** button.

Configuring Slave Units

More than one Matrix Controller can be connected to a network. When using multiple Matrix Controllers, one Matrix Controller must be configured as a *master* and the remaining Matrix Controllers are configured as *slave*. By default, each Matrix Controller is configured as a *master*. Matrix Controllers can be configured as a *slave* in either [Combined Mode](#) (page 9) or [Separate Mode](#) (page 13) mode.

1. Connect a shielded CAT-5e (or better) cable from the network to the **LAN 1** port of the Matrix Controller that will be configured as a *slave*.

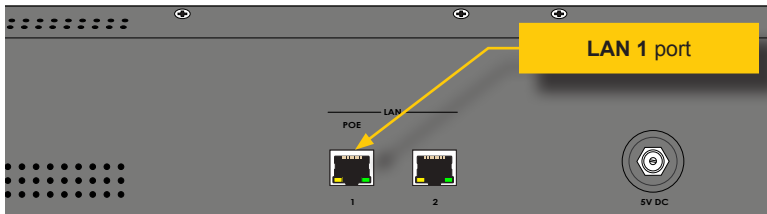

2. Access the web interface of the Matrix Controller and click the **System > Basic Settings** tab.
3. Click the **Slave** button. The button will turn red when it is activated.

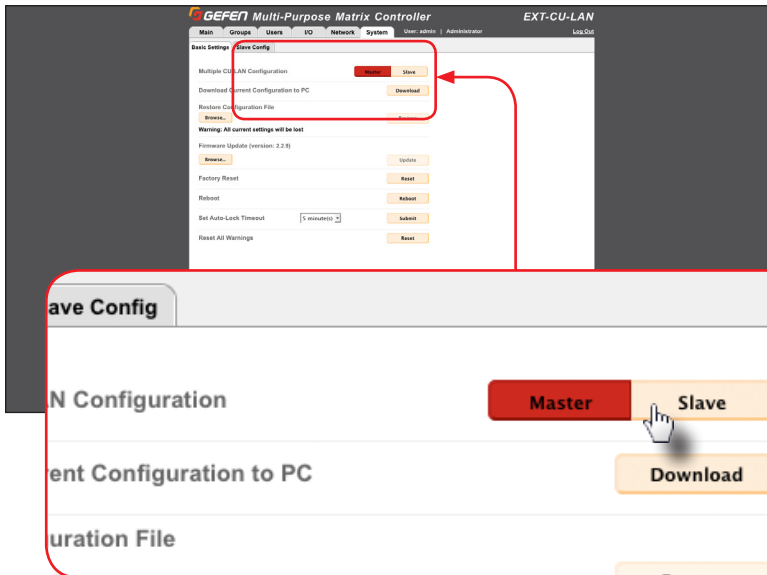

- The following message box will be displayed:

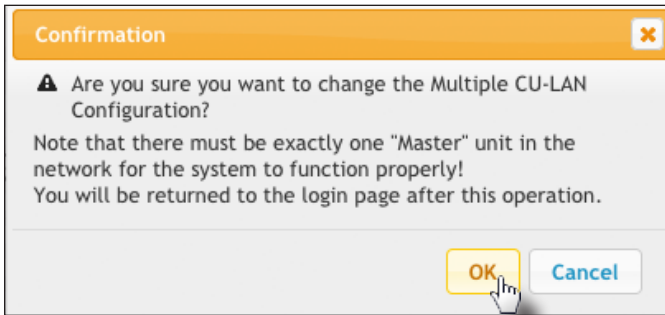

- Click the **OK** button.
- The login screen will be displayed. Enter the administrator username and password and then click the **Login** button.

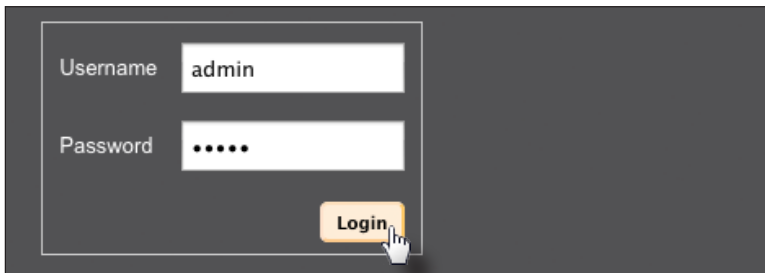

- Return to the **System > Basic Settings** tab and click the **Reboot** button.

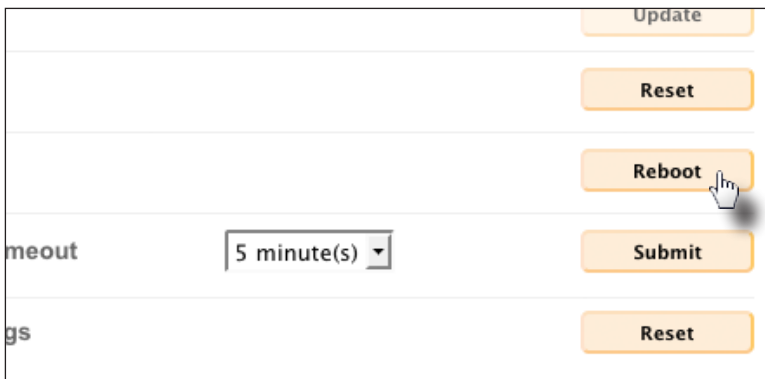

- The following message box will be displayed. Click the **OK** button to reboot the Matrix Controller.

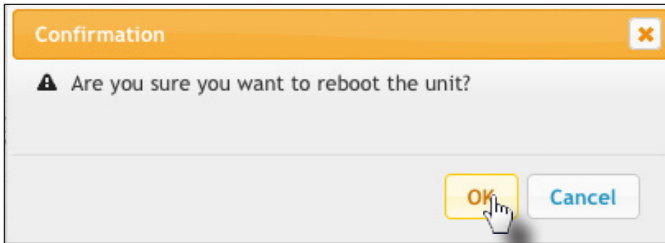

- Click the **OK** on the following message box when it is displayed:

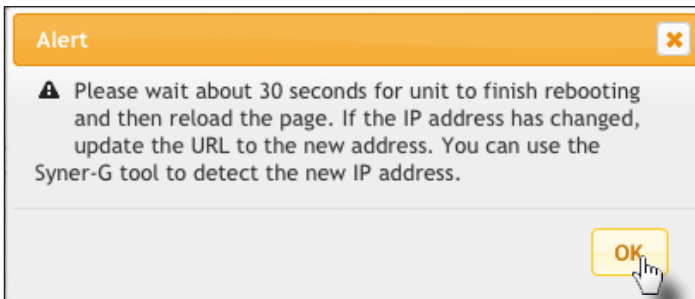

- The following message box will be displayed while the Matrix Controller is rebooting.

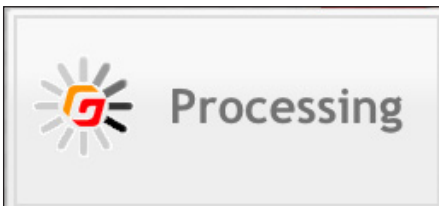

The Matrix Controller is now set-up as a *slave*. Next, we have to let the Master system know about the *slave* system.

- Access the web interface of the *Master* system.
- Click the **Refresh** button under the **System > Slave Config** tab.

The *slave* Matrix Controller will now appear under the **Connected Slaves** section, as shown on the next page.

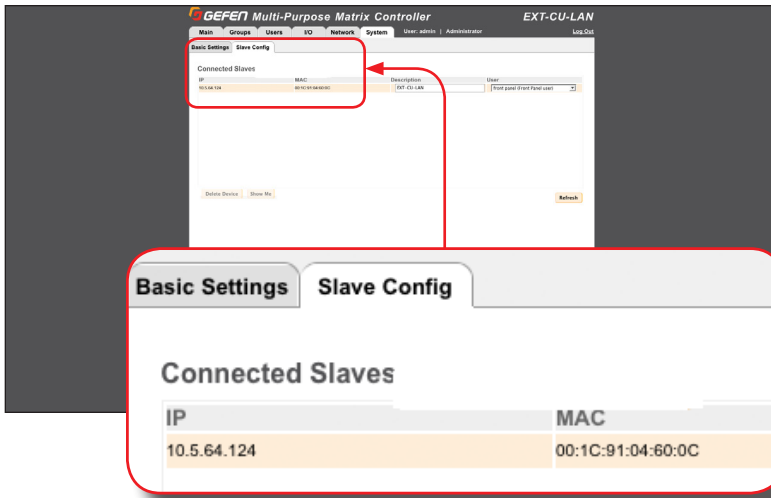

To the right of the IP address and MAC address, the **Description** and **User** fields are displayed. The **Description** field can be changed as desired. For example, we could change this field to “EXT-CU-LAN Slave” for easy identification by the Gefen Syner-G software.

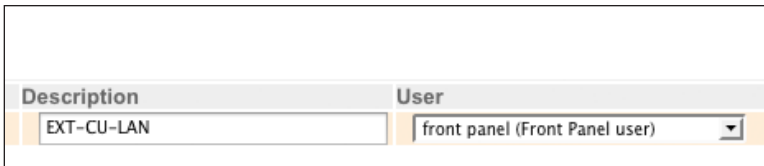

Notes and restrictions on using *slave* Matrix Controllers:

- ▶ Users with Slave access level do not have access to the menu system on the front panel. To allow access to the menu system on a *slave* unit, add the front panel user.
- ▶ Additional time may be required for a *slave* Matrix Controller to register changes within the system. This includes adding new users and connecting KVM over IP-based products to the network.
- ▶ If a KVM over IP-based product is removed from the system, it is recommended to click the **Refresh** button under the **System > Slave Config** tab of the *master* Matrix Controller.
- ▶ To switch a *slave* Matrix Controller to a *master*, the *slave* Matrix Controller must be reset to factory-default settings. Click the **Reset** button under the **System > Basic Settings** tab of the *slave* Matrix Controller.

This section will concentrate on the configuration of each KVM over IP device on the network. Configuration of KVM over IP devices must always be handled using the *master* Matrix Controller.

1. Click the **I/O** tab.
2. All Gefen KVM over IP products, that are connected to the network, will be displayed under the **Input** and **Output** lists, as shown below. The Matrix Controller automatically discovers all available Gefen KVM over IP products.

Inputs

Ch	IP	MAC	Description	Mode
1	192.168.1.80	00:1C:91:04:41:09	LG blu-ray	Auto
2	192.168.1.81	00:1C:91:04:31:01	DSPM- Coke	Auto
3	192.168.1.82	00:1C:91:04:41:03	DSPM Gefen products	Auto
5	192.168.1.84	00:1C:91:04:30:80	DSPM2	Auto
6	192.168.1.85	00:1C:91:03:D2:B8	VGA-Siggen	Auto
8	192.168.1.87	00:1C:91:03:C0:8A	none	Auto
9	192.168.1.88	00:1C:91:04:32:08	Roku3	Auto
10	192.168.1.83	00:1C:91:04:30:78	Fitzi-Teemu	Auto
11	192.168.1.86	00:1C:91:03:C2:48	DTS blu-ray	Auto

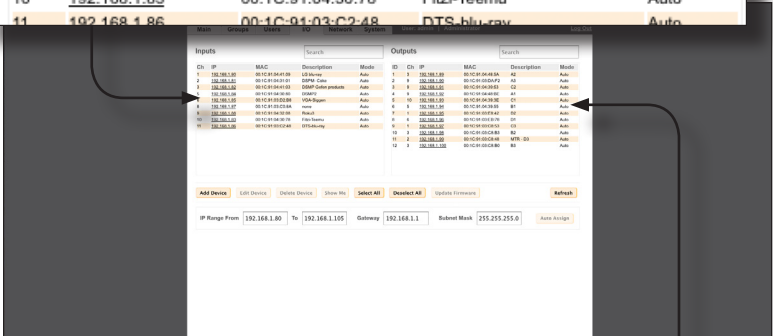

Outputs

ID	Ch	IP	MAC	Description	Mode
1	3	192.168.1.89	00:1C:91:04:48:5A	A2	Auto
2	9	192.168.1.90	00:1C:91:03:DA:F2	A3	Auto
3	9	192.168.1.91	00:1C:91:04:39:53	C2	Auto
4	9	192.168.1.92	00:1C:91:04:48:BE	A1	Auto
5	10	192.168.1.93	00:1C:91:04:39:3E	C1	Auto
6	5	192.168.1.94	00:1C:91:04:39:55	B1	Auto
7	1	192.168.1.95	00:1C:91:03:E8:42	D2	Auto
8	6	192.168.1.96	00:1C:91:03:EB:78	D1	Auto
9	1	192.168.1.97	00:1C:91:03:C8:53	C3	Auto

Important

Before proceeding, contact your IT administrator for a valid range of consecutive IP addresses that can be applied to the Gefen KVM over IP products (e.g. 192.168.1.100 to 192.168.1.150).

- Enter the provided IP addresses (from the IT administrator) in the IP Range From and To fields. The IP address range should meet the following requirements:
 - The range should be large enough to include all of the devices that will eventually be added to the network, with room for possible expansion.
 - The IP addresses should be outside of the assigned DHCP range assigned by the network router.
 - The IP addresses should not be assigned to any existing devices in this range (including devices such as laptop computers that may currently be disconnected, but which have previously been assigned addresses in this range).



- Click the **Select All** button to select all discovered devices under the **Input** and **Output** list. Any time a device is selected from either list, it will be highlighted in red.

Ch	IP	MAC	Description	Mode
1	192.168.1.80	00:1C:91:04:41:09	LG blu-ray	Auto
2	192.168.1.81	00:1C:91:04:31:01	DSPM- Coke	Auto
3	192.168.1.82	00:1C:91:04:41:03	DSMP Gefen products	Auto
5	192.168.1.84	00:1C:91:04:30:80	DSMP2	Auto
6	192.168.1.85	00:1C:91:03:D2:B8	VGA-Siggen	Auto
8	192.168.1.87	00:1C:91:03:C0:8A	none	Auto
9	192.168.1.88	00:1C:91:04:32:08	Roku3	Auto
10	192.168.1.83	00:1C:91:04:30:78	Fitzj-Teemu	Auto
11	192.168.1.86	00:1C:91:03:C2:48	DTS-blu-ray	Auto

5. Click the **Auto Assign** button on the right side of the screen, under the **Outputs** list.

ID	Ch	IP	MAC	Description	Mode
1	3	192.168.1.89	00:1C:91:04:48:5A	A2	Auto
2	9	192.168.1.90	00:1C:91:03:DA:F2	A3	Auto
3	9	192.168.1.91	00:1C:91:04:39:53	C2	Auto
4	9	192.168.1.92	00:1C:91:04:48:BE	A1	Auto
5	10	192.168.1.93	00:1C:91:04:39:3E	C1	Auto
6	5	192.168.1.94	00:1C:91:04:39:55	B1	Auto
7	1	192.168.1.95	00:1C:91:03:E8:42	D2	Auto
8	6	192.168.1.96	00:1C:91:03:EB:78	D1	Auto
9	1	192.168.1.97	00:1C:91:03:C8:53	C3	Auto
10	3	192.168.1.98	00:1C:91:03:C8:B3	B2	Auto
11	2	192.168.1.99	00:1C:91:03:C8:48	MTR - D3	Auto
12	3	192.168.1.100	00:1C:91:03:C8:B0	B3	Auto

6. The following message box will be displayed:

Confirmation
✕

⚠ The Auto Assign feature will take several minutes to complete. Length of time will depend on the quantity of selected devices. Multiple resets on each device will occur during this process. The EXT-CU-LAN will not be accessible during this process. Would you like to continue?

During the **Auto Assign** procedure, the Gefen KVM over IP products may reboot multiple times.

The Web interface will not be available during this process. DO NOT attempt to refresh the page during the process.

7. Click the **OK** button to continue.
8. The following message box will be displayed and will disappear when the process has completed:

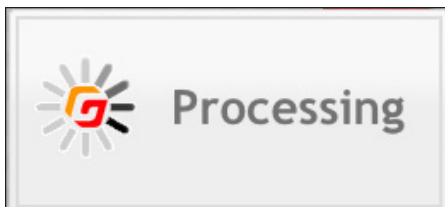

9. Provide a unique description for each input and output device. Make sure the descriptions are meaningful (e.g. "Blu-ray", "Samsung 65", etc.). This step is highly recommended and will provide easy management of devices, particularly in large-scale setups.



Important

Do not use special characters, such as double-quotes ("), asterisks (*), etc., in any text field. Only these special characters are supported: (space), underscore (_), hyphen (-), and period (.).

To change the description of an input or output unit, do the following:

- a. Click on the desired unit, from the **Input** or **Output** list, to select it. In this example, we will begin by selecting an input device.

Inputs				
Ch	IP	MAC	Description	Mode
1	192.168.1.80	00:1C:91:04:41:09	LG blu-ray	Auto
2	192.168.1.81	00:1C:91:04:31:01	DSPM- Coke	Auto
3	192.168.1.82	00:1C:91:04:41:03	DSMP Gefen products	Auto
5	192.168.1.84	00:1C:91:04:30:80	DSMP2	Auto

- b. When selected, the device will be highlighted in red.

Inputs				
Ch	IP	MAC	Description	Mode
1	192.168.1.80	00:1C:91:04:41:09	LG blu-ray	Auto
2	192.168.1.81	00:1C:91:04:31:01	DSPM- Coke	Auto
3	192.168.1.82	00:1C:91:04:41:03	EXT-HD2IRS-LAN-S	Auto
5	192.168.1.84	00:1C:91:04:30:80	DSMP2	Auto
6	192.168.1.85	00:1C:91:04:30:80	VGA-Sigma	Auto

- c. Click the **Edit Device** button. Note that only one device can be changed at a time. If more than one device is selected, then the **Edit Device** button will be disabled.

Inputs

Search

Ch	IP	MAC	Description	Mode
1	192.168.1.80	00:1C:91:04:41:09	LG blu-ray	Auto
2	192.168.1.81	00:1C:91:04:31:01	DSPM- Coke	Auto
3	192.168.1.82	00:1C:91:04:41:03	EXT-HD2IRS-LAN-S	Auto
5	192.168.1.84	00:1C:91:04:30:80	DSMP2	Auto
6	192.168.1.85	00:1C:91:03:D2:B8	VGA-Siggen	Auto
8	192.168.1.87	00:1C:91:03:C0:8A	none	Auto
9	192.168.1.88	00:1C:91:04:32:08	Roku3	Auto
10	192.168.1.83	00:1C:91:04:30:78	Fitzi-Teemu	Auto
11	192.168.1.86	00:1C:91:03:C2:48	DTS-blu-ray	Auto

Add Device

Edit Device

Delete Device

Show Me

Select All

- d. The **Edit Device** dialog box will be displayed.

Edit Device
✕

Channel	3	DNS	Optional
Name	EXT-HD2IRS-LAN-S	Web GUI Port	80
MAC	00:1C:91:04:41:03	Telnet Port	23
IP	192.168.1.82	FW Version	V1.63hs
IP Mode	Static	HW Version	ast1510hv
Gateway	192.168.1.1	Web GUI	http://192.168.1.82:80
Subnet	255.255.255.0	Description	EXT-HD2IRS-LAN-S

Save

Cancel

- e. The default device name will be displayed in the **Description** field. Click in the **Description** field and change the name.

Web GUI <http://192.168.1.82:80>

Description

- f. Click the **Save** button on the **Edit Device** dialog.

Web GUI <http://192.168.1.82:80>

Description

Save **Cancel**

- g. The *processing* message box will be displayed and after a few seconds, the device description will be updated.

Inputs

Ch	IP	MAC	Description	Mode
1	192.168.1.80	00:1C:91:04:41:09	LG blu-ray	Auto
2	192.168.1.81	00:1C:91:04:31:01	DSMP- Coke	Auto
3	192.168.1.82	00:1C:91:04:41:03	DSMP Gefen products	Auto
5	192.168.1.84	00:1C:91:04:30:80	DSMP2	Auto

- h. Repeat steps a - g for each device under both the Input and Output list.



Important

Before continuing, verify that all units have an IP address that is within the specified range. Each input device should have a unique Channel number. Each output device should have a unique ID number.

This page left intentionally blank.

Matrix Controller

2

Basic Operation

Groups, Users, and Members

In order to introduce a level of organization to how end-users interact with the Matrix Controller, it is important to first define the concepts of *groups*, *users*, and *members*.

- ▶ A *group* is a collection of both *members* and inputs / outputs. Groups are created under the **Groups** tab in the Web interface. See [Creating Groups \(page 38\)](#).
- ▶ A *user* is a name identifier that is created and assigned an administrator or operator *access level*. We'll discuss *access level* in the next section. Users are created under the **Users** tab in the Web interface. See [Creating Users \(page 30\)](#).
- ▶ A *member* is a *user* that has been assigned to a *group*. It is important to make the distinction between a *user* and a *member*. *Members* are managed under the **Groups > Members** tab in the Web interface. See [Adding Members \(page 47\)](#).

Now that we have defined each term, we can put them together in an illustration.

In the diagram, below, we have created two *groups*: **Sales and Accounting**. Each *group* contains three *members*. The small rectangles within each *group* represent an arbitrary number of inputs and outputs that are assigned to the *group*.

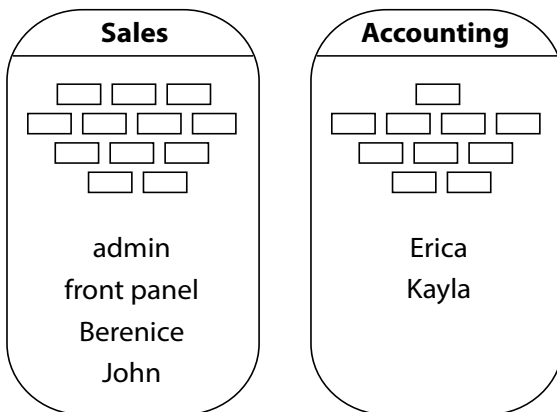

It should be noted that *users* only have routing access to the *group* (or groups) to which they are assigned. Let's look at an example

The user “Berenice” is currently assigned to **Sales** and she will only be able to access the set of inputs and outputs that are within the **Sales group**. She cannot access the inputs and outputs in the **Accounting group** because she is not a *member* of that *group*.

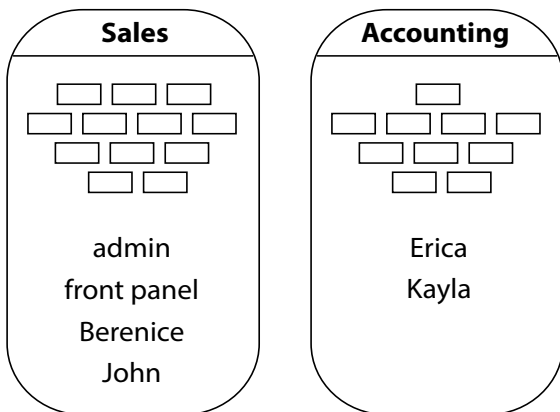

Now, let’s add “Berenice” to the **Accounting group**. When logging in to the Web interface, “Berenice” will now be able to access the inputs and outputs under both the **Sales group** and the **Accounting group**.

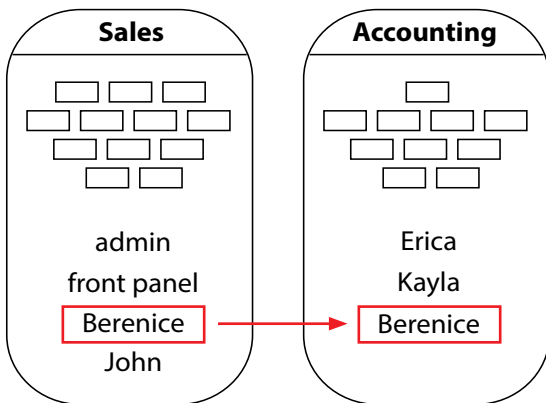

Creating Users

The Matrix Controller includes two default *users*: **admin** and **front panel**. When a *user* is created, they can have one of the following *access levels*: **Administrator**, **Group Administrator**, or **Operator**. By default, both **admin** and **front panel** users have **Administrator** access. Creating *users* requires **Administrator** access.

1. Click the **Users** tab.

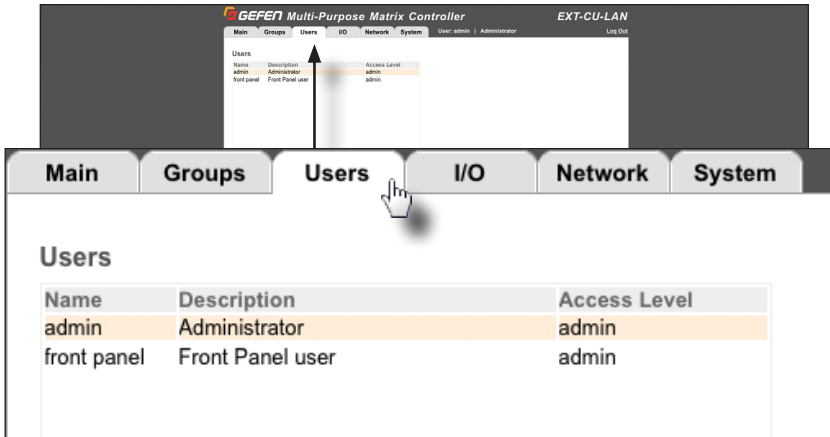

2. Click the **Add User** button.

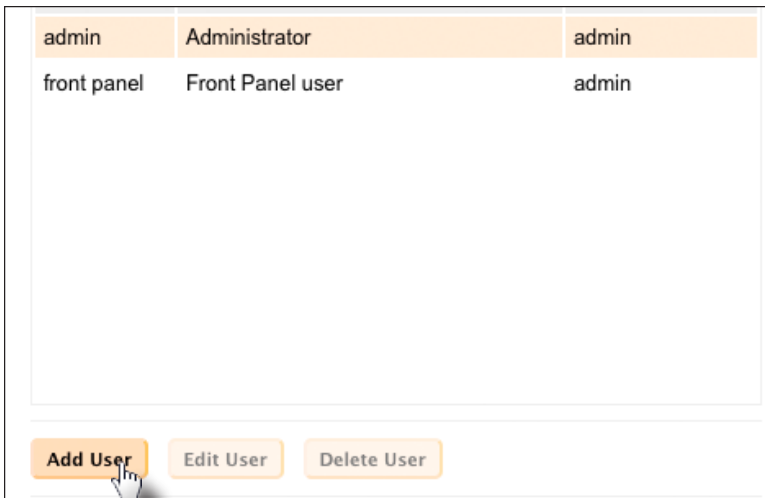

3. The **Add User** dialog will be displayed.
 - d. Type the name of the *user* in the **Name** field.
 - e. Enter a description for the *user* in the **Description** field.
 - f. Click on the **Access Level** drop-down list to select the user access level: **Operator**, **Group Administrator**, **Administrator**, or **Slave**. See [User Access Level Summary \(page 32\)](#) for detailed information on user access levels.

The screenshot shows the 'Add User' dialog box. The 'Name' field contains 'Berenice'. The 'Description' field contains 'Sales Administrator'. The 'Access Level' dropdown menu is open, showing the following options: 'Operator', 'Group Administrator' (which is highlighted in blue), 'Administrator', and 'Slave'. The 'Password' and 'Group Memberships' fields are empty. At the bottom of the dialog, there are two buttons: 'Add' and 'Cancel'.

- g. Create a password for the *user*. The password can be up to 10 characters in length. The password will be masked when entered.
- h. Click the **Add** button.



Important

If the user "front panel" is set to Operator access level, then the menu system cannot be accessed through the front panel.

4. Repeat Steps 2 - 3 for each *user* that is created.

Although you may create any *user ID* you wish, it is not recommended to create a *user* called "operator" or "administrator" as this can be confused with the *access level* of the *user*.

User Access Level Summary

The following tables provide an overview of the features and functions that are available to a user, based on their *access level*.

General					
Access Level	Password	Routing	Blocking	Masking	Edit System Settings
Administrator	Alphanumeric	Yes	Yes	Yes	Yes
Front Panel	Numeric	Yes	Yes	Yes	Yes
Group Administrator	Alphanumeric	Yes	Yes	Yes	No
Operator	Alphanumeric	Yes	Yes	Yes	No
Slave	Numeric	Yes	Yes	Yes	No

Preset Management *			
Access Level	User Presets	Group Presets	Quick Presets
Administrator	Yes	Yes	No
Front Panel	Yes	Yes	Yes
Group Administrator	Yes	Yes	No
Operator	Yes	No	No
Slave	Yes	No	Yes

* Indicates the capabilities of a user to create, edit, and access a **User**, **Group**, or **Quick** preset.

Group Management **		
Access Level	Create Groups	Manage Group Members
Administrator	Yes	Yes
Front Panel	Yes	Yes
Group Administrator	No	Yes
Operator	No	No
Slave	No	No

** Indicates the capabilities of a user to create *groups* or manage *group members*.

Deleting Users

Deleting a *user* will remove that *user* from the **Users** list. To remove a *user* from a *group*, without permanently deleting the *user* profile, see [Removing Members \(page 49\)](#).

1. Click the **Users** tab.
2. Click on the *user* to be deleted. In the example, below, we delete the *user* **jeff**.

Users

Name	Description	Access Level
admin	Administrator	admin
front panel	Front Panel user	admin
Berenice	Sales Administrator	admin
Jeff	Accounting	operator



Add User **Edit User** **Delete User**

3. Click the **Delete user** button.
4. The *user* will be deleted.

Users

Name	Description	Access Level
admin	Administrator	admin
front panel	Front Panel user	admin
Berenice	Sales Administrator	admin

Editing Users

Editing a *user* allows you to change the **Description**, **Access Level**, and/or **Password** of any *user*. The two exceptions are: 1) The `admin user` can only have the password changed. 2) The `front panel user` can only have the *access level* and/or *passcode* changed.



Information

The `front panel passcode` must consist of six numerical digits and must be between four and ten characters in length. Alphabetic characters are not permitted.

1. Click the **Users** tab.
2. Click on the *user* to be edited. In the example, below, we have selected **Berenice**.

Users

Name	Description	Access Level
admin	Administrator	admin
front panel	Front Panel user	admin
Berenice	Sales Administrator	group administrator

Add User
Edit User
Delete User

3. Click the **Edit User** button to display the **Edit User** dialog.

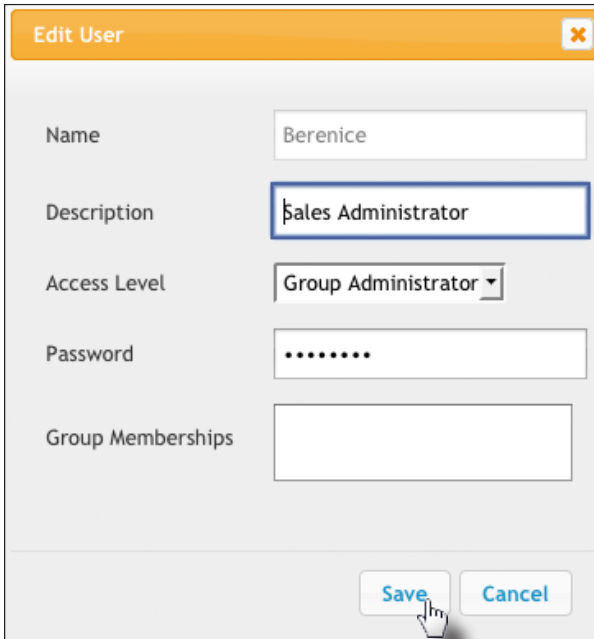

The screenshot shows a dialog box titled "Edit User" with a close button in the top right corner. The dialog contains the following fields:

- Name:** Berenice
- Description:** Sales Administrator
- Access Level:** Group Administrator (dropdown menu)
- Password:** Masked with seven dots
- Group Memberships:** Empty text box

At the bottom of the dialog are two buttons: "Save" and "Cancel". A mouse cursor is hovering over the "Save" button.

4. Make any desired changes to the **Description**, **Access Level**, and/or **Password** fields.

The **Name** field cannot be changed. To change the *user* name, delete the *user* from the **Members** tab, then create the new *user* name. See [Deleting Users \(page 33\)](#) and [Adding Members \(page 47\)](#) for more information.

If the *user* is already a *member* of a *group*, then the **Group Memberships** field will automatically be filled with the name of each *group*.

Note that if the *user* is not a *member* of a *group*, then this field will be blank.

5. After the desired changes have been made, click the **Save** button.

The Default Group

The **DEFAULT** group is automatically provided by the Matrix Controller and allows immediate access to routing capabilities without having to create *groups* and *users*. Unlike other groups that are created, the **Edit name/description** button and the **Delete group** button will not be available when the **DEFAULT** group is used.

1. Click the **Groups** tab.
2. Click the **Input/Output** tab.
3. The **DEFAULT** group will be displayed.

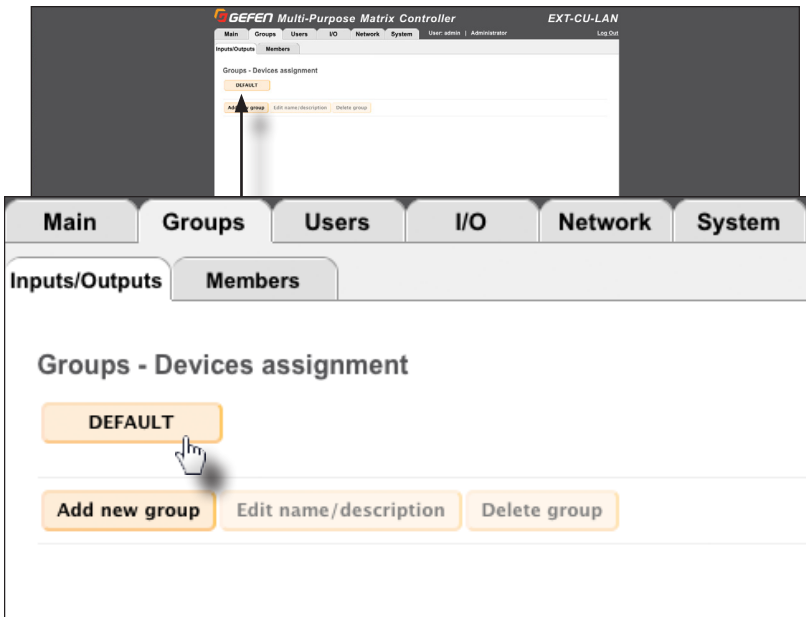

4. Click the **DEFAULT** group button.
 5. The list of all detected inputs will be listed under the **Associated Inputs** column.
 6. The list of all detected outputs will be listed under the **Associated Output** column.
- See the next page for an illustration.

Associated Inputs

Search

Name	IP	MAC	Description
EXT-HD2IRS-...	192.168.1.80	00:1C:91:04:4...	LG blu-ray
EXT-DVIKVM-...	192.168.1.81	00:1C:91:04:3...	DSPM - Coke
EXT-HD2IRS-...	192.168.1.82	00:1C:91:04:4...	DSPM Gefen ...
EXT-DVIKVM-...	192.168.1.83	00:1C:91:04:3...	Fitzi-Teemu
EXT-DVIKVM-...	192.168.1.84	00:1C:91:04:3...	DSMP2
EXT-HDKVM-...	192.168.1.86	00:1C:91:03:C...	DTS-blu-ray
EXT-DVIKVM-...	192.168.1.87	00:1C:91:03:C...	none
EXT-DVIKVM-...	192.168.1.88	00:1C:91:04:3...	Roku3
EXT-VGAKVM...	192.168.1.85	00:1C:91:03:D...	VGA-Siggen

The screenshot shows the 'Groups - Devices assignment' page. It features a navigation bar with 'Main', 'Groups', 'Users', 'IO', 'Network', 'System', 'User administration', and 'Administration'. Below the navigation, there are tabs for 'Inputs/Outputs' and 'Members'. The 'Groups - Devices assignment' section includes a 'SEARCH' button and a 'test' button. There are also buttons for 'Add new group', 'Edit group description', and 'Delete group'. The 'Associated Inputs' section has a search bar and a list of inputs with columns for Name, IP, MAC, and Description. The 'Associated Outputs' section also has a search bar and a list of outputs with the same columns. Arrows indicate the mapping between the tables in the screenshot and the tables in the document.

Associated Outputs

Search

Name	IP	MAC	Description
EXT-HDKVM-...	192.168.1.99	00:1C:91:03:C...	MTR - D3
EXT-DVIKVM-...	192.168.1.95	00:1C:91:03:E...	D2
EXT-HDKVM-...	192.168.1.100	00:1C:91:03:C...	B3
EXT-HD2IRS-...	192.168.1.92	00:1C:91:04:4...	A1
EXT-DVIKVM-...	192.168.1.93	00:1C:91:04:3...	C1
EXT-DVIKVM-...	192.168.1.94	00:1C:91:04:3...	B1
EXT-HD2IRS-...	192.168.1.89	00:1C:91:04:4...	A2
EXT-DVIKVM-...	192.168.1.96	00:1C:91:03:E...	D1
EXT-HDKVM-...	192.168.1.97	00:1C:91:03:C...	C3
EXT-HDKVM-...	192.168.1.98	00:1C:91:03:C...	B2
EXT-DVIKVM-...	192.168.1.91	00:1C:91:04:3...	C2
EXT-VGAKVM...	192.168.1.90	00:1C:91:03:D...	A3

Creating Groups

A *group* contains both a set of units (inputs and outputs) for routing. Within each *group*, one or more *members* are included. Once a *group* is created, we can add the units and the users that will be able to access them. An unlimited number of groups can be created. See [Groups, Users, and Members](#) (page 28) for more information on groups.

1. Click the **Groups** tab.
2. Click the **Input/Output** tab.

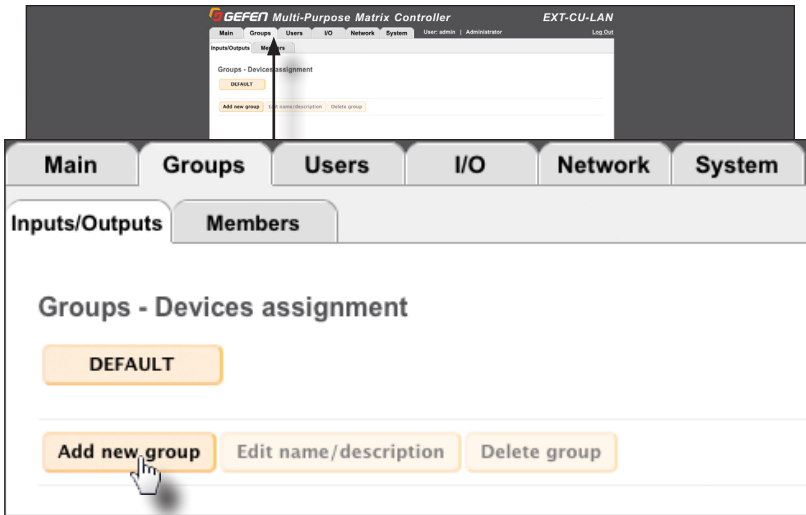

3. Click the **Add new group** button to view the **Add new group** dialog.

The screenshot shows the 'Add new group' dialog box. It has a title bar with the text 'Add new group' and a close button (X). The dialog contains two text input fields: 'Name' and 'Description'. Both fields have a blue border and the text 'Required' inside. Below the fields are two buttons: 'Save' and 'Cancel'.

4. Enter the name of the *group* in the **Name** field.
5. Enter the description for the *group* in the **Description** field.

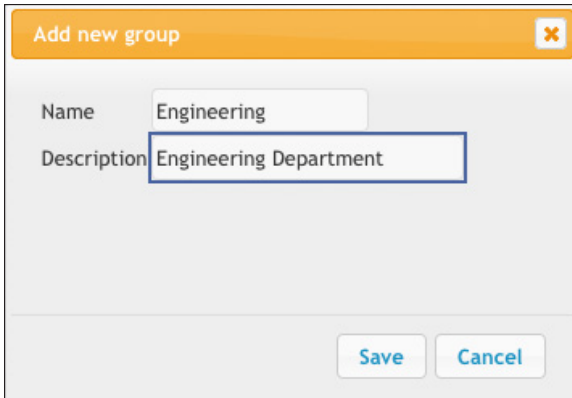

The screenshot shows a dialog box titled "Add new group". It has a close button in the top right corner. The "Name" field contains the text "Engineering" and the "Description" field contains the text "Engineering Department". At the bottom of the dialog are two buttons: "Save" and "Cancel".

Creating groups allows the administrator to restrict user-access to specified inputs and outputs. When using a large number of KVM over IP devices, it will be necessary to create and manage groups of devices for tracking, management, and ease-of-use.

6. Click the **Save** button to create the group. Each group that is created will appear as a button.

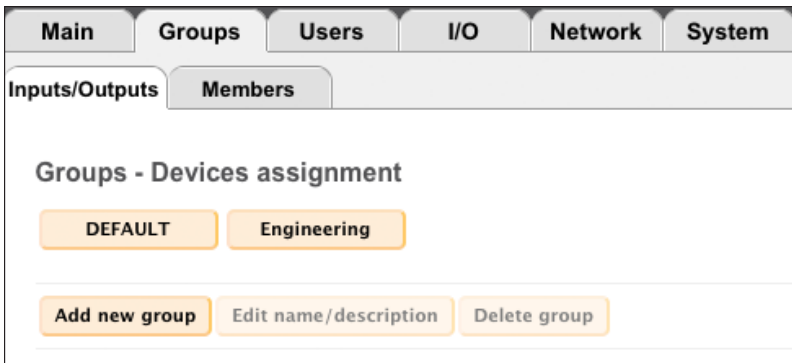

Deleting Groups

1. Click the **Groups** tab.
2. Click either the **Inputs/Outputs** or **Members** tab. In this example, we will click the **Members** tab.
3. Click on the *group* to be deleted. In the example, below, we have clicked the **Sales** *group* button.
4. Click the **Delete group** button.

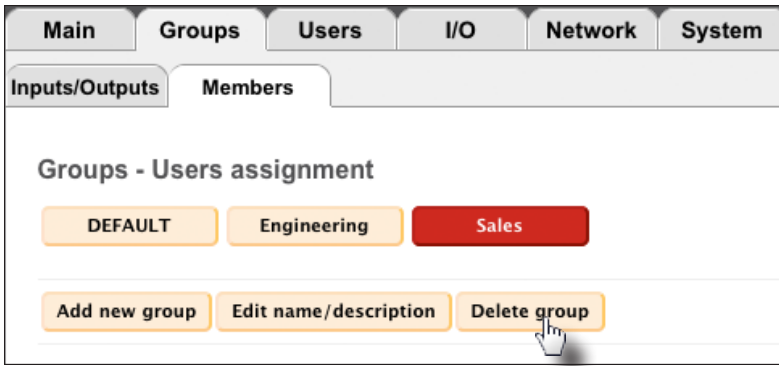

5. The following message box will be displayed.

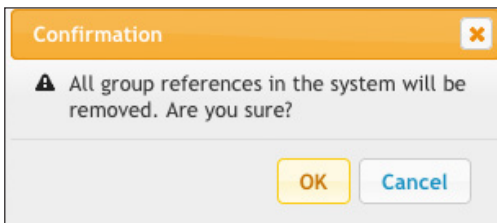

6. Click the **OK** button to delete the selected *group*. Click the **Cancel** button to cancel the procedure.

Editing Groups

1. Click the **Groups** tab.
2. Click either the **Inputs/Outputs** or **Members** tab. In this example, we will click the **Members** tab.
3. Click on the desired *group*. In the example, below, we have clicked the **Engineering** *group* button.
4. Click the **Edit name / description** button.

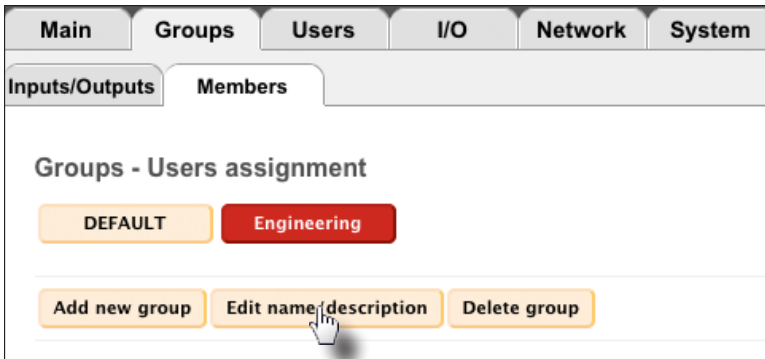

5. The **Update group** dialog will be displayed.

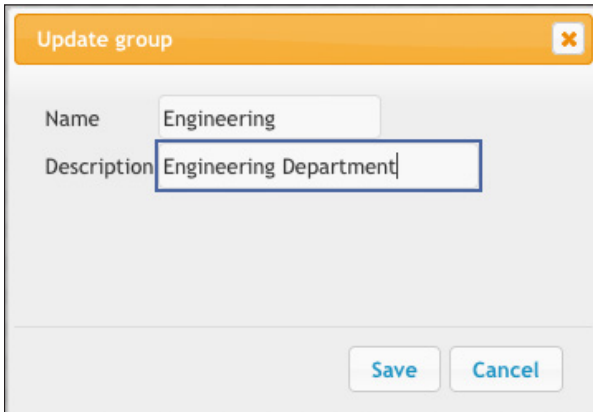

6. Change the **Name** and/or **Description** fields, as desired.
7. Click the **Save** button to accept the changes. Click the **Cancel** button to cancel the changes.

Adding Inputs and Outputs

Before we can route an input to one or more outputs, we must first define which inputs and outputs are available within the *group*. We do this by adding inputs and outputs to the **Associated Inputs** and **Associated Outputs** list.

1. Click the **Groups** tab.
2. Click the **Inputs/Outputs** tab.
3. Click on the desired *group*.
4. Select the desired inputs, under the **Available Inputs** list. All available input devices, detected by the Matrix Controller, will be listed under the **Available Inputs** list.

Available Inputs

Name	IP	MAC	Description
EXT-HD2IRS-...	192.168.1.80	00:1C:91:04:4...	LG blu-ray
EXT-DVIKVM-...	192.168.1.81	00:1C:91:04:3...	DSPM- Coke
EXT-HD2IRS-...	192.168.1.82	00:1C:91:04:4...	DSMP Gefen ...
EXT-DVIKVM-...	192.168.1.83	00:1C:91:04:3...	Fitzi-Teemu
EXT-DVIKVM-...	192.168.1.84	00:1C:91:04:3...	DSMP2
EXT-HDKVM-...	192.168.1.86	00:1C:91:03:C...	DTS-blu-ray
EXT-DVIKVM-...	192.168.1.87	00:1C:91:03:C...	none
EXT-DVIKVM-...	192.168.1.88	00:1C:91:04:3...	Roku3
EXT-VGAKVM...	192.168.1.85	00:1C:91:03:D...	VGA-Siggen

5. Click the arrow icon, pointing to the right.

Name	IP	MAC	Description
D2IRS-...	192.168.1.80	00:1C:91:04:4...	LG blu-ray
VIKVM-...	192.168.1.81	00:1C:91:04:3...	DSPM- Coke
D2IRS-...	192.168.1.82	00:1C:91:04:4...	DSMP Gefen ...
VIKVM-...	192.168.1.83	00:1C:91:04:3...	Fitzi-Teemu
VIKVM-...	192.168.1.84	00:1C:91:04:3...	DSMP2
DKVM-...	192.168.1.86	00:1C:91:03:C...	DTS-blu-ray
VIKVM-...	192.168.1.87	00:1C:91:03:C...	none
VIKVM-...	192.168.1.88	00:1C:91:04:3...	Roku3
AKVM-...	192.168.1.85	00:1C:91:03:D...	VGA-Siggen

6. The selected inputs will appear under the **Associated Inputs** list.

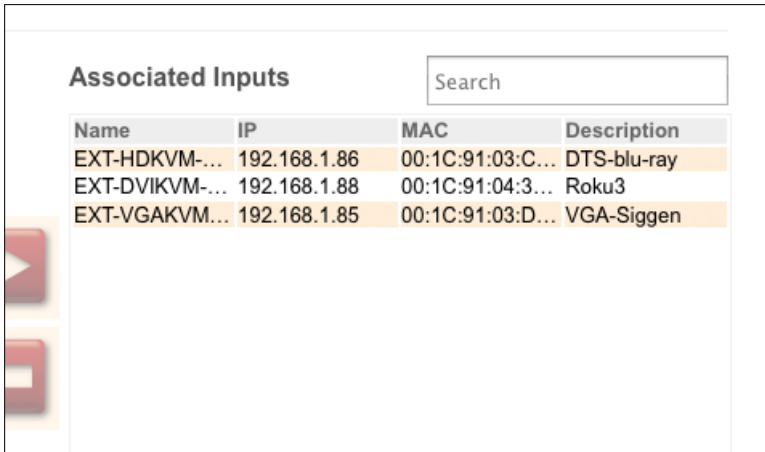

Name	IP	MAC	Description
EXT-HDKVM-...	192.168.1.86	00:1C:91:03:C...	DTS-blu-ray
EXT-DVIKVM-...	192.168.1.88	00:1C:91:04:3...	Roku3
EXT-VGAKVM-...	192.168.1.85	00:1C:91:03:D...	VGA-Siggen

7. Select the desired outputs, under the **Available Outputs** list, to be associated with this *group*. All available output devices, detected by the Matrix Controller, will be listed under the **Available Outputs** list.

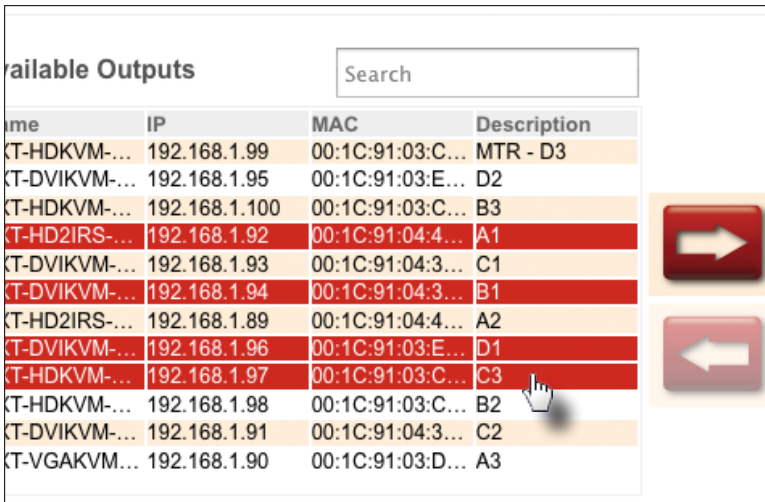



Name	IP	MAC	Description
KT-HDKVM-...	192.168.1.99	00:1C:91:03:C...	MTR - D3
KT-DVIKVM-...	192.168.1.95	00:1C:91:03:E...	D2
KT-HDKVM-...	192.168.1.100	00:1C:91:03:C...	B3
KT-HD2IRS-...	192.168.1.92	00:1C:91:04:4...	A1
KT-DVIKVM-...	192.168.1.93	00:1C:91:04:3...	C1
KT-DVIKVM-...	192.168.1.94	00:1C:91:04:3...	B1
KT-HD2IRS-...	192.168.1.89	00:1C:91:04:4...	A2
KT-DVIKVM-...	192.168.1.96	00:1C:91:03:E...	D1
KT-HDKVM-...	192.168.1.97	00:1C:91:03:C...	C3
KT-HDKVM-...	192.168.1.98	00:1C:91:03:C...	B2
KT-DVIKVM-...	192.168.1.91	00:1C:91:04:3...	C2
KT-VGAKVM-...	192.168.1.90	00:1C:91:03:D...	A3

8. Press the arrow icon, pointing to the right, to move the selected outputs under the **Associated Outputs** list.

Available Outputs



Name	IP	MAC	Description
EXT-HDKVM-...	192.168.1.99	00:1C:91:03:C...	MTR - D3
EXT-DVIKVM-...	192.168.1.95	00:1C:91:03:E...	D2
EXT-HDKVM-...	192.168.1.100	00:1C:91:03:C...	B3
EXT-HD2IRS-...	192.168.1.92	00:1C:91:04:4...	A1
EXT-DVIKVM-...	192.168.1.93	00:1C:91:04:3...	C1
EXT-DVIKVM-...	192.168.1.94	00:1C:91:04:3...	B1
EXT-HD2IRS-...	192.168.1.89	00:1C:91:04:4...	A2
EXT-DVIKVM-...	192.168.1.96	00:1C:91:03:E...	D1
EXT-HDKVM-...	192.168.1.97	00:1C:91:03:C...	C3
EXT-HDKVM-...	192.168.1.98	00:1C:91:03:C...	B2

9. The selected outputs will appear under the **Associated Outputs** list.

Associated Outputs

Name	IP	MAC	Description
EXT-HD2IRS-...	192.168.1.92	00:1C:91:04:4...	A1
EXT-DVIKVM-...	192.168.1.94	00:1C:91:04:3...	B1
EXT-DVIKVM-...	192.168.1.96	00:1C:91:03:E...	D1
EXT-HDKVM-...	192.168.1.97	00:1C:91:03:C...	C3

Removing Inputs and Outputs

Removing inputs and/or outputs is the opposite of adding them. Removing an input or output moves it to the **Available Inputs** or **Available Outputs** list, respectively, making it unavailable for routing.

1. Click the **Groups** tab.
2. Click the **Inputs/Outputs** tab.
3. Click on the desired *group*.
4. Start with either the **Associated Inputs** or **Associated Outputs** list. The process for removing inputs or outputs is the same. In this example, we will remove two inputs.
5. Select the desired input(s).

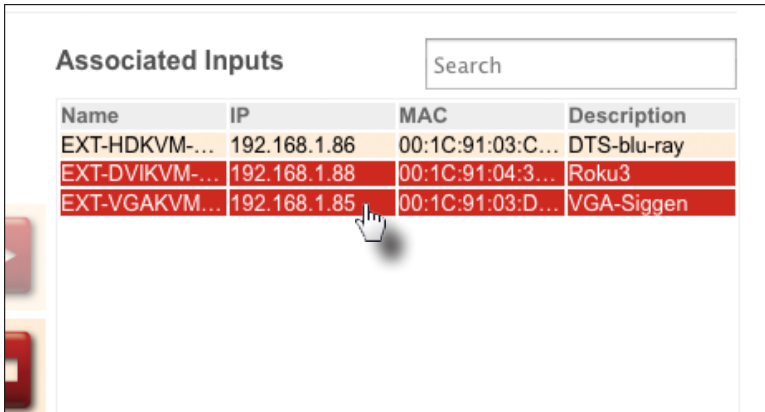

6. Click the arrow icon, pointing to the left.

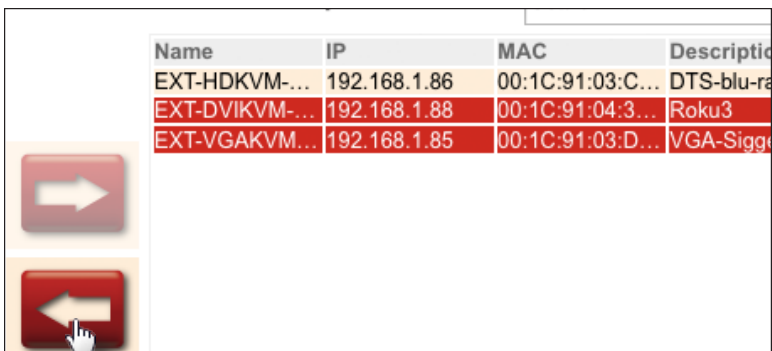

7. The selected inputs, under the **Associated Inputs** list will be moved under the **Available Inputs** list.

Associated Inputs

Name	IP	MAC	Description
EXT-HDKVM-...	192.168.1.86	00:1C:91:03:C...	DTS-blu-ray

Available Inputs

Name	IP	MAC	Description
EXT-HD2IRS-...	192.168.1.80	00:1C:91:04:4...	LG blu-ray
EXT-DVIKVM-...	192.168.1.81	00:1C:91:04:3...	DSMP- Coke
EXT-HD2IRS-...	192.168.1.82	00:1C:91:04:4...	DSMP Gefen ...
EXT-DVIKVM-...	192.168.1.83	00:1C:91:04:3...	Fitzi-Teemu
EXT-DVIKVM-...	192.168.1.84	00:1C:91:04:3...	DSMP2
EXT-DVIKVM-...	192.168.1.87	00:1C:91:03:C...	none
EXT-DVIKVM-...	192.168.1.88	00:1C:91:04:3...	Roku3
EXT-VGAKVM-...	192.168.1.85	00:1C:91:03:D...	VGA-Siggen

Now, when routing inputs to outputs (under the **Main** tab), this particular *group* will have only one input instead of three.

Adding Members

Next, we need to add users to each *group* that we created. When a *user* is added to a *group*, the *user* is referred to as a *member*.

1. Click the **Groups** tab.
2. Click the **Members** tab.
3. Click on the desired *group*.

Groups - Users assignment

DEFAULT Engineering **Sales**

Add new group Edit name/description Delete group

Available users

Name	Description	Access
admin	Administrator	admin
front panel	Front Panel user	admin
Berenice	Sales Administrator	group administrator
John	Sales Representative	operator
Erica	Accounting AR	group administrator

4. Click the desired *user*(s) to be assigned to the selected *group*.

Available users

Name	Description	Access
admin	Administrator	admin
front panel	Front Panel user	admin
Berenice	Sales Administrator	group administrator
John	Sales Representative	operator
Erica	Accounting AR	group administrator
Kayla	Accounting AP	operator



Important

The `admin` user must be added to the group in order for the group to appear under the **Main** tab. In addition, the `front_panel` user must be added to a group in order to allow routing from the front panel of the Matrix Controller. See [Routing \(page 51\)](#) for more information on the **Main** tab.

- Click the arrow icon, pointing to the right, to move the selected *user(s)* under the **Members** list. Users can belong to multiple groups.

Description	Access
Administrator	admin
Front Panel user	admin
Sales Administrator	group administrator
Sales Representative	operator
Accounting AR	group administrator
Accounting AP	operator



- The selected *users* (`admin`, `front panel`, `john`, and `kayla`) are now *members* of this *group*.

Members			Search
Name	Description	Access	
admin	Administrator	admin	
front panel	Front Panel user	admin	
Berenice	Sales Administrator	group administrator	
John	Sales Representative	operator	



Removing Members

As with removing inputs and/or outputs, removing a *member* from a *group* does not delete the *member*. Removing a *member* from a *group* simply prevents that *user* from accessing the *group*. To permanently delete a *member* / *user*, see [Deleting Users](#) (page 33).

1. Click the **Groups** tab.
2. Click the **Members** tab.
3. Click on the desired *group*.
4. Click the desired *user* under the **Members** list. In this example, we will select **John**.

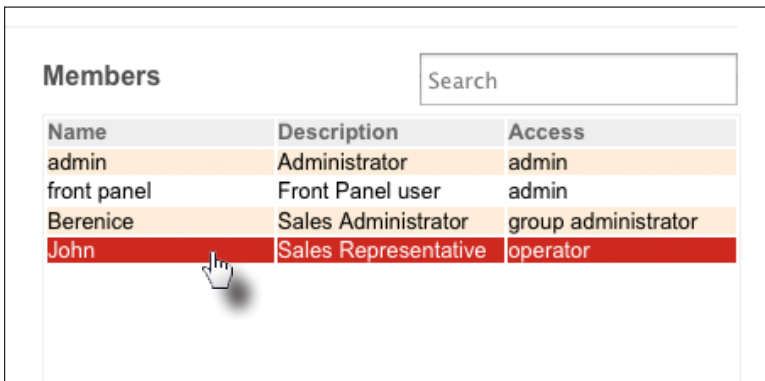

Members		
Name	Description	Access
admin	Administrator	admin
front panel	Front Panel user	admin
Berenice	Sales Administrator	group administrator
John	Sales Representative	operator

5. Click the arrow icon, pointing to the left.

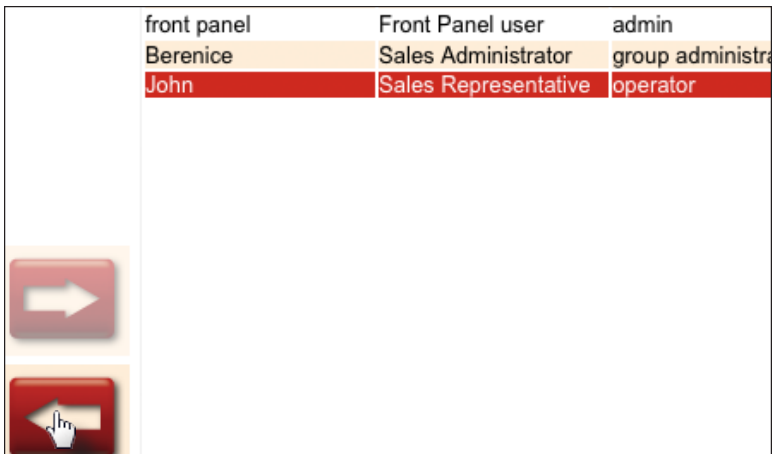

front panel	Front Panel user	admin
Berenice	Sales Administrator	group administrator
John	Sales Representative	operator

6. The selected *member* is now moved under the **Available users** list.

Members

Name	Description	Access
admin	Administrator	admin
front panel	Front Panel user	admin
Berenice	Sales Administrator	group administrator

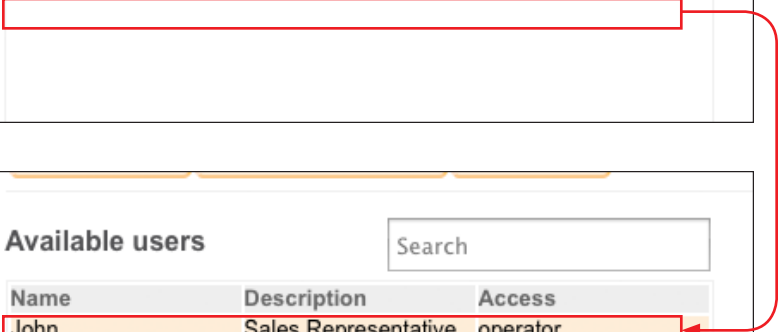

Available users

Name	Description	Access
John	Sales Representative	operator
Erica	Accounting AR	group administrator
Kayla	Accounting AP	operator

Inputs to Outputs

1. Click **Main** tab.
2. Click the desired *group* button.

The screenshot shows the 'Main' tab selected in the top navigation bar. Below it, the 'Groups' section has three buttons: 'DEFAULT', 'Engineering' (highlighted in red), and 'Sales'. A 'Dynamic Help' box contains the text: 'Select one or more outputs and then click Route to apply ch'. Below this, the 'Inputs' section has two buttons: 'Block On' and 'Block Off', followed by a search input field. A table lists the inputs:

Ch	Name	Description
1	EXT-HD2IRS-LAN-S	LG blu-ray
5	EXT-DVIKVM-LAN-L-S	DSMP2
10	EXT-DVIKVM-LAN-L-S	Fitzi-Teemu

A mouse cursor is pointing at the first row of the table. To the right, a 'Route' button with a left-pointing arrow is partially visible.

3. Click to select an input from the **Inputs** list. To deselect the input, click on it again. Only one input can be selected at a time. If the selected input is already routed to one or more outputs, the outputs will be highlighted in orange, as shown below:

The screenshot shows the 'Outputs' section of the interface. It has two buttons: 'Mask On' and 'Mask Off', followed by a search input field. A table lists the outputs:

ID	Ch	Name	Description
7	1	EXT-DVIKVM-LAN-R	D2
11	2	EXT-HDKVM-LAN-R	MTR - D3
12	3	EXT-HDKVM-LAN-R	B3

- Click to select the desired outputs, under the **Outputs** list.

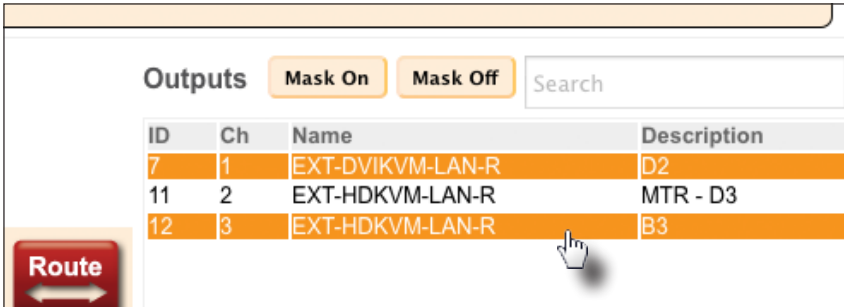

- Click the **Route** button.

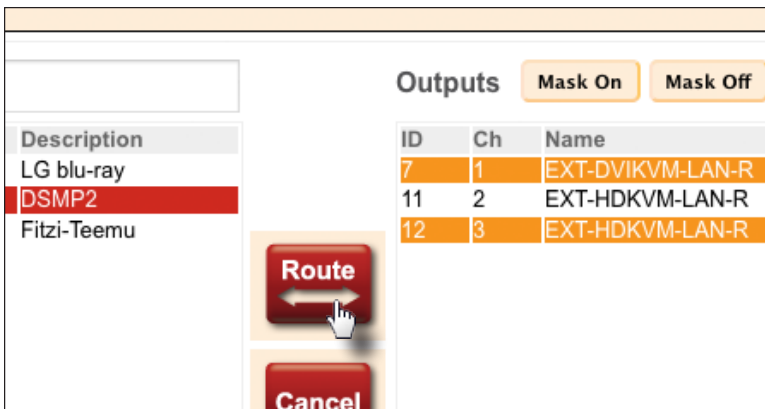

- The processing message box will be displayed, while the new routing process takes effect. This message box will disappear when the routing process is complete.

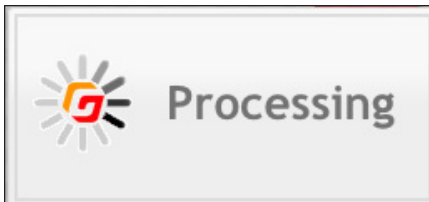

Outputs to Inputs

1. Click the desired output(s) from the **Output** list. To deselect the output, click on it again. If the output is already routed to an input, the input will be highlighted in red, under the **Inputs** list.

Outputs Mask On Mask Off Search

ID	Ch	Name	Description
7	1	EXT-DVIKVM-LAN-R	D2
11	2	EXT-HDKVM-LAN-R	MTR - D3
12	3	EXT-HDKVM-LAN-R	B3

2. Select the desired input, from the **Inputs** list. Only one input can be selected at a time.

Inputs Block On Block Off Search

Ch	Name	Description
1	EXT-HD2IRS-LAN-S	LG blu-ray
5	EXT-DVIKVM-LAN-L-S	DSMP2
10	EXT-DVIKVM-LAN-L-S	Fitzi-Teemu

3. Select additional outputs, from under the **Outputs** list, as desired.
4. Click the **Route** button.

Outputs Mask On Mask Off Search

ID	Ch	Name	Description
7	1	EXT-DVIKVM-LAN-R	D2
11	2	EXT-HDKVM-LAN-R	MTR - D3
12	3	EXT-HDKVM-LAN-R	B3

Route

Blocking Inputs

The Matrix Controller allows an input to be blocked. This prevents the input signal from reaching one or more output(s). Depending upon where the input is routed, this can affect multiple outputs at a time. To block the signal on specific outputs, see [Masking Outputs](#) (page 56).

1. Click the **Main** tab.
2. Click the desired *group* button.
3. Click the desired input from the **Inputs** list. Only one input can be clicked at a time. In this example, we will select the first input (**LG blu-ray**).

The screenshot shows the GEFEN Multi-Purpose Matrix Controller interface. The 'Inputs' section is active, displaying a table of inputs. The first input, 'EXT-HD2IRS-LAN-S', is highlighted in red and has the description 'LG blu-ray'. A mouse cursor is pointing at the 'Block On' button above the table.

Ch	Name	Description
1	EXT-HD2IRS-LAN-S	LG blu-ray
5	EXT-DVIKVM-LAN-L-S	DSMP2
10	EXT-DVIKVM-LAN-L-S	Fitzi-Teemu

4. Click the **Block On** button.

This close-up screenshot shows the 'Inputs' list with the 'Block On' button highlighted by a mouse cursor. The table below shows the same three inputs as in the previous screenshot.

Ch	Name	Description
1	EXT-HD2IRS-LAN-S	LG blu-ray
5	EXT-DVIKVM-LAN-L-S	DSMP2
10	EXT-DVIKVM-LAN-L-S	Fitzi-Teemu

5. The following message box will be displayed, as the selected input is blocked.

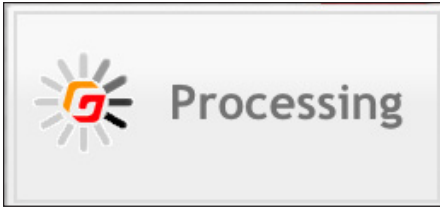

6. Once the input is blocked, a black rectangle will appear under the **Ch** column, next to the selected input, as shown:

Dynamic Help: Select one or more outputs and then click Route to apply changes.

Inputs	Block On	Block Off	Search
Ch	Name	Description	
1	EXT-HD2IRS-LAN-S	LG blu-ray	
5	EXT-DVIKVM-LAN-L-S	DSMP2	
10	EXT-DVIKVM-LAN-L-S	Fitzi-Teemu	

All outputs to which this input is routed, will not longer receive the source signal.

7. To unblock an input, select the blocked input and click the **Block Off** button.

Masking Outputs

The Matrix Controller allows selected outputs to be masked. When an output is masked, the signal is blocked on the output. To block the signal on the input, see [Blocking Inputs](#) (page 54).

1. Click the **Main** tab.
2. Click the desired *group* button.
3. Click the desired output(s) from the **Output** list. In this example, we will click on the following outputs: **D2** and **B3**.

The screenshot shows the GEFE Multi-Purpose Matrix Controller interface. The 'Outputs' list is displayed with the following data:

ID	Ch	Name	Description
7	1	EXT-DVIKVM-LAN-R	D2
11	2	EXT-HDKVM-LAN-R	MTR - D3
12	3	EXT-HDKVM-LAN-R	B3

The 'Mask On' button is highlighted, and a mouse cursor is pointing at the 'B3' output row.

4. Click the **Mask On** button.

The close-up screenshot shows the 'Outputs' list with the 'Mask On' button highlighted by a mouse cursor. The data in the table is the same as in the previous screenshot:

ID	Ch	Name	Description
7	1	EXT-DVIKVM-LAN-R	D2
11	2	EXT-HDKVM-LAN-R	MTR - D3
12	3	EXT-HDKVM-LAN-R	B3

5. The following message box will be displayed, as the selected output is masked.

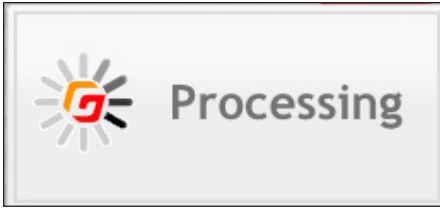

6. Once the outputs are masked, a black rectangle will appear under the **Ch** column, next to the selected outputs, as shown:

The screenshot shows the GEFEN Multi-Purpose Matrix Controller interface. The main window displays a routing table with columns for ID, Ch, Name, and Description. A modal window titled 'Outputs' is open, showing a table with the same columns. The 'Ch' column in the modal window has black rectangles under the rows with IDs 7, 11, and 12, indicating they are masked. A mouse cursor is pointing at the black rectangle under ID 12.

ID	Ch	Name	Description
7	1	EXT-DVIKVM-LAN-R	D2
11	2	EXT-HDKVM-LAN-R	MTR - D3
12	3	EXT-HDKVM-LAN-R	B3

7. To unmask an output, select the masked output(s) and click the **Mask Off** button.

Matrix View Mode

By default, inputs and outputs are arranged in a *list view*. *Matrix view* arranges all inputs and outputs in a “grid”, providing an intuitive layout during routing process.

1. Click the **Main** tab.
2. Click the desired *group* button.
3. Click the **Matrix View** icon, next to the **List View** icon.

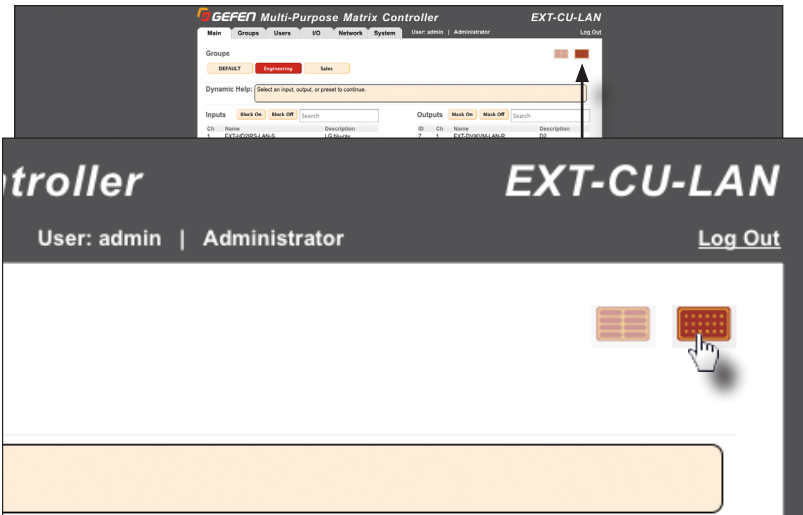

4. The *matrix view* will be displayed for the selected *group*.

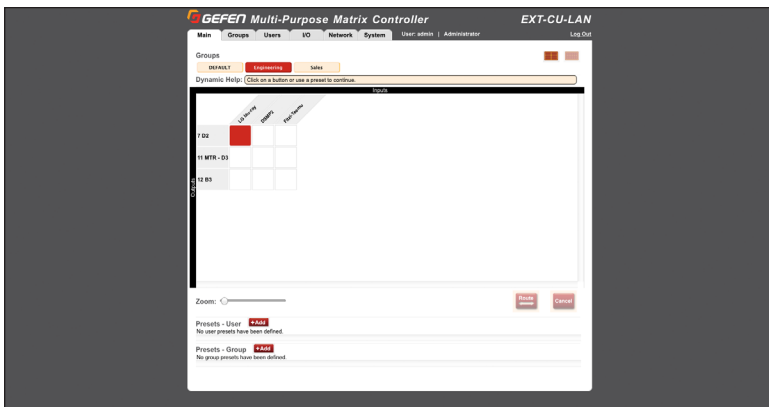

If we look at *matrix view*, we can see that it contains a listing of each input and output that was assigned to the *group*. In this case, the **Engineering** *group* has three inputs and three outputs.

When the *matrix view* is displayed, it will always indicate the current routing status of each input and output. Inputs are listed by column and the outputs are listed by row.

In the example, below, the device **LG blu-ray** (input) is routed to **7 D2** (output). For each output, the *channel number* precedes the *device description*.

The screenshot shows a web interface for routing. At the top, there are tabs: Main, Groups, Users, I/O, Network, and System. The 'Groups' tab is active, showing three buttons: DEFAULT, Engineering (highlighted in red), and Sales. Below the buttons is a 'Dynamic Help' box with the text: 'Click on a button or use a preset to continue.'

The main area is a routing matrix. The columns are labeled 'Inputs' and contain: LG blu-ray, DSMP2, and Fitzi-Teemu. The rows are labeled 'Outputs' and contain: 7 D2, 11 MTR - D3, and 12 B3. A red square is located at the intersection of the '7 D2' row and the 'LG blu-ray' column, indicating a routing assignment.

Outputs	Inputs	LG blu-ray	DSMP2	Fitzi-Teemu
7 D2				
11 MTR - D3				
12 B3				

5. Locate the desired input using the columns. For this example, we will route **DSMP2** (input) to both of the following outputs: **11 MTR - D3** and **12 B3**.

We can perform the routing in any order and will start by routing **DSMP2** to **11 MTR - D3** by placing the mouse cursor over the "intersection" of both **DSMP2** and **11 MTR - D3**.

The location of the mouse cursor will be indicated by a highlighted column and row, within the *matrix view*, as shown:

Groups

DEFAULT **Engineering** Sales

Dynamic Help: Click on a button or use a preset to continue.

		Inputs		
		LG blu-ray	DSMP2	Fitzzi-Teemu
Outputs	7 D2			
	11 MTR - D3			
	12 B3			

- Click where the mouse cursor is located. The square, indicated by the highlighted column and row, will turn red.

		Inputs		
		LG blu-ray	DSMP2	Fitzzi-Teemu
Outputs	7 D2			
	11 MTR - D3			
	12 B3			

7. Select any additional inputs and outputs using the same process. In our example we also wanted to route **DSMP2** to **12 B3**.

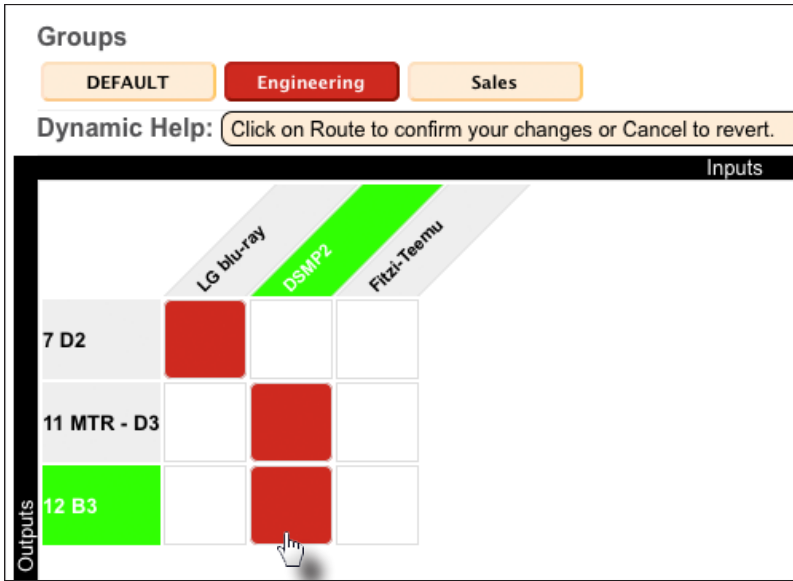

8. After the desired inputs and outputs are selected, click the **Route** button in the lower-left corner of the screen.

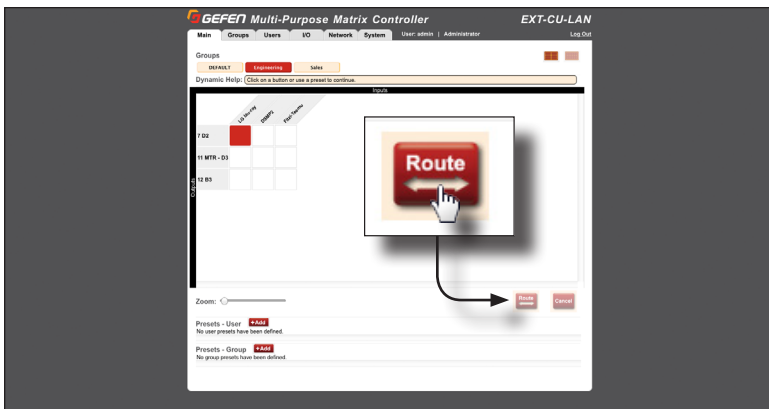

9. To access the *matrix view* for a different group, click the desired *group* button.
10. The *matrix view* for the selected *group* will automatically be displayed.

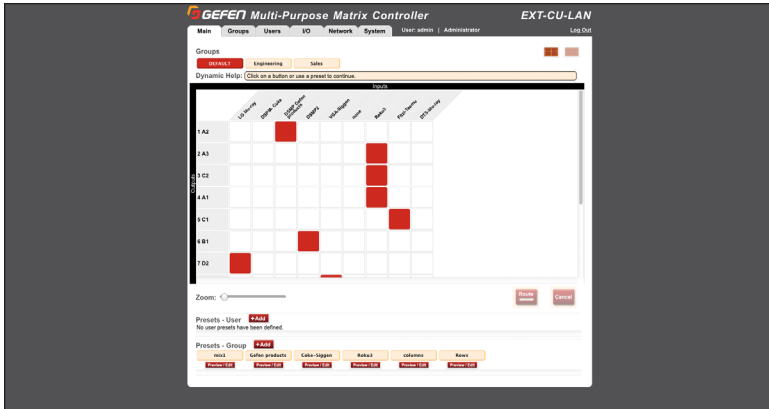

If the matrix view extends beyond the window, use the **Zoom** slider bar to fit the *matrix view* within the window.

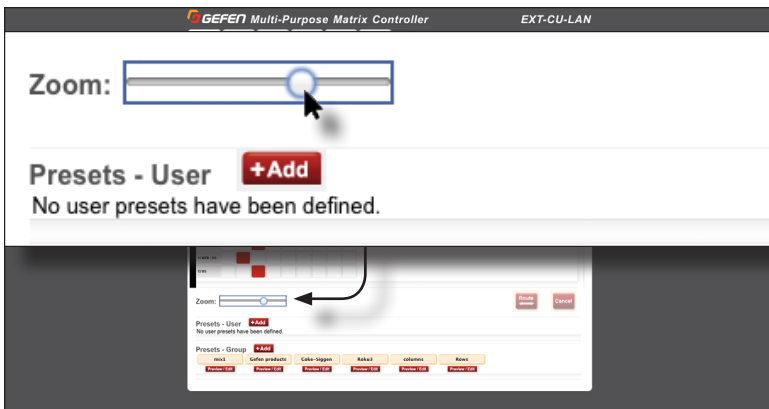

11. To return to the list view, click the List View icon, next to the Matrix View icon:

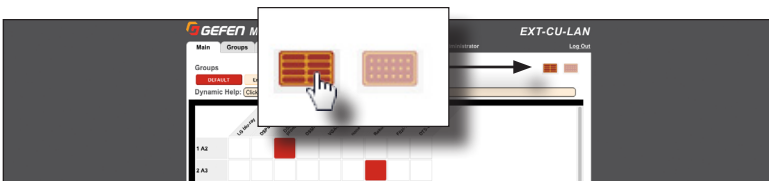

The Matrix Controller provides two types of presets: **User** and **Group**. When a *user preset* is created, it will only be available to the *user* for which it was created. When a *group preset* is created, it will be available to all users. In the examples, below, we will illustrate the creation of both a *user preset* and a *group preset*.

Creating User Presets

1. Click the **Main** tab.
2. Click the desired *group* button.
3. Near the bottom of the screen, click the **+Add** button, next to **Presets - User**.

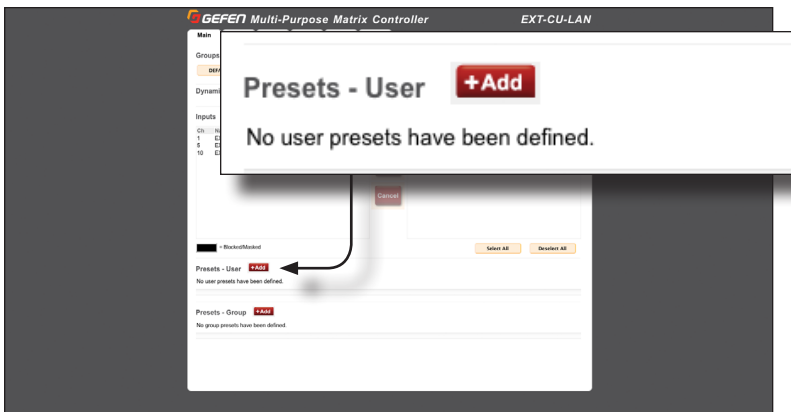

4. The **New preset** dialog will be displayed.

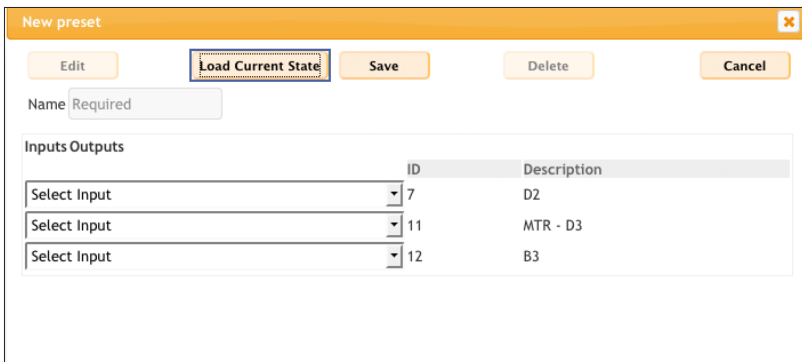

5. Enter the name of the preset in the **Name** field. This is required.
6. Perform one of the following:
 - ▶ Click the **Load Current State** button to use the current routing state as a preset. If this option is used, skip to Step 9.
 - ▶ Click the drop-down list, under the **Inputs** column.
7. The drop-down list will display all available inputs. The **Outputs** column will list all available outputs.
8. Select the desired input from the drop-down list, for each output that is listed.

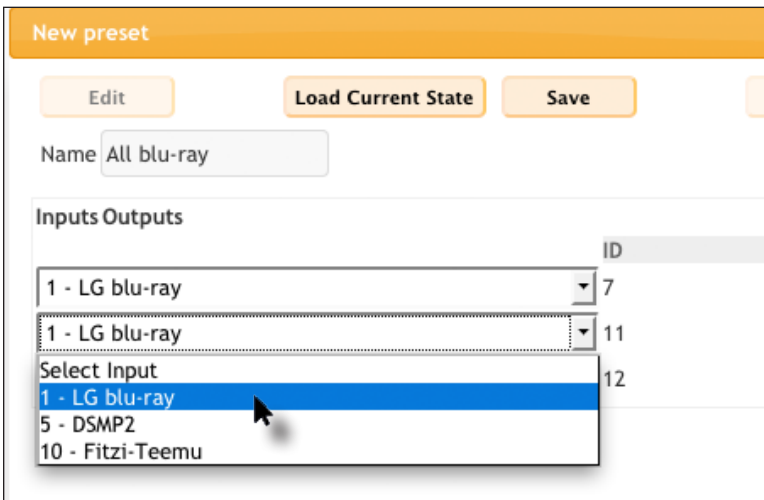

For demonstration purposes, our *group* only contains three inputs and three outputs. The input(s) and output(s) that are displayed in this dialog box will be determined by the devices which have been assigned to the **Associated Inputs** and **Associated Outputs** column under the **Group** menu.

When creating *user* presets, only one input can be selected for each output that is listed. Only inputs can be selected. Outputs cannot be selected when creating a preset. If you wish to change the availability of an output, under the **Outputs** column, go to the **Groups** menu and change the list of **Associated Outputs**, as desired.

See [Creating Groups \(page 38\)](#) for more information.

9. Click the **Save** button to save the preset or click the **Cancel** button to close the **New preset** dialog box.
10. After the preset has been saved, a button will appear (with the provided name), under the **Presets - User** column, near the bottom of the page.

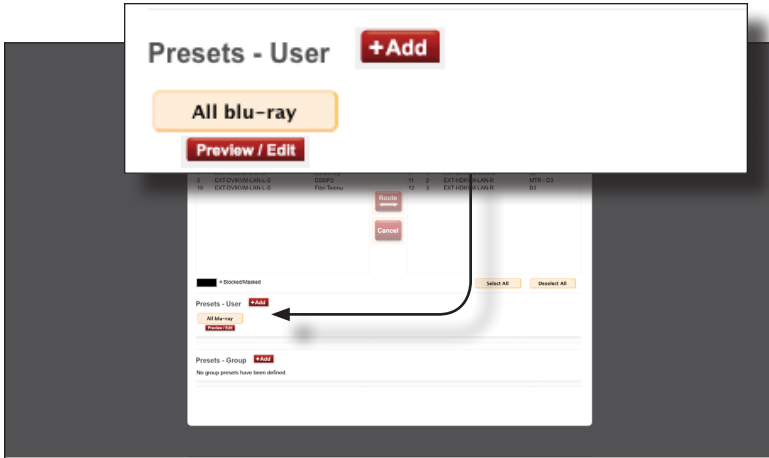

11. To create additional presets, repeat steps 3 - 9.
12. To edit a preset, click the **Preview / Edit** button under the desired preset.

Creating Group Presets

When a *group preset* is created, it will be available to all groups. If you wish to create presets that are dependent upon the *user*, refer to [Creating User Presets \(page 63\)](#).

1. Click the **Main** tab.
2. Click the desired *group* button to display the available inputs and outputs.
3. Near the bottom of the screen, click the **+Add** button, next to **Presets - Groups**.

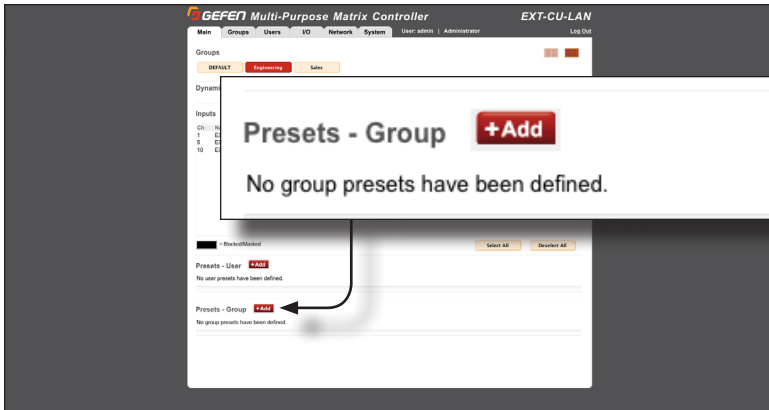

4. The **New preset** dialog will be displayed.

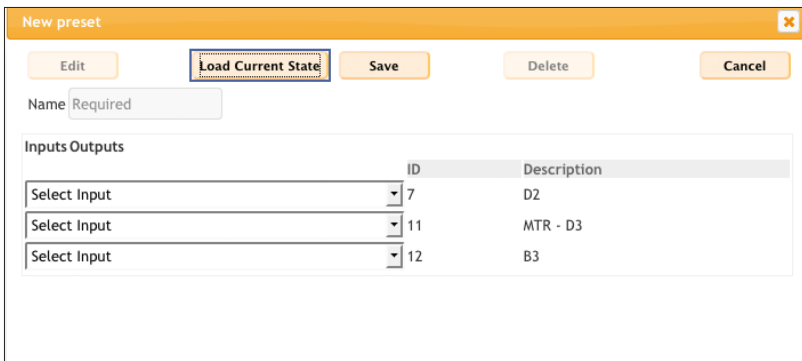

5. Enter the name of the preset in the **Name** field. This is required.
6. Perform one of the following:
 - ▶ Click the **Load Current State** button to use the current routing state as a preset. If this option is used, skip to Step 8.
 - ▶ Click the drop-down list, under the **Inputs** column.
7. Click the drop-down list, under the **Inputs** column, and select the desired input. Only one input can be selected.

Inputs	Outputs	ID	De
5 - DSMP2		7	DZ
5 - DSMP2		11	MT
Select Input		12	B3

For demonstration purposes, our *group* only contains three inputs and three outputs. The input(s) and output(s) that are displayed in this dialog box will be determined by the devices which have been assigned to the **Associated Inputs** and **Associated Outputs** column under the **Group** menu.

When creating *user* presets, only one input can be selected for each output that is listed. Only inputs can be selected. Outputs cannot be selected when creating a preset. If you wish to change the availability of an output, under the **Outputs** column, go the **Groups** menu and change the list of **Associated Outputs**, as desired.

See [Creating Groups \(page 38\)](#) for more information.

8. Click the **Save** button to save the changes to the preset or click the **Cancel** button to close the **New preset** dialog box.
9. After the preset has been saved, a button will appear (with the provided name), under the **Presets - User** column, near the bottom of the page.

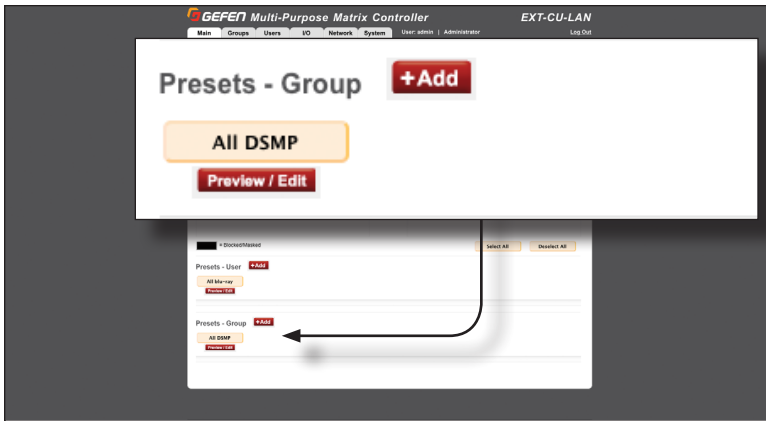

In the example, below, we've created both a *user preset* and a *group preset*. See [Creating User Presets \(page 63\)](#) for more information on User Presets.

Although not visible on the button, a prefix number is automatically assigned to the preset. The prefix numbers are used by the front panel display, as well as Telnet commands, when specifying a preset.

To view the assigned number of a preset, click the **Preview / Edit** button of the desired preset.

In the example, below, we can see that the Matrix Controller has assigned this preset as **1**.

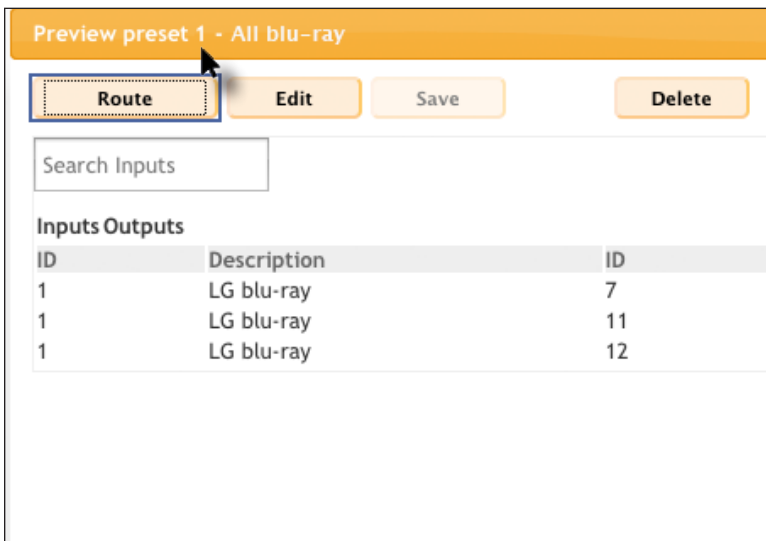

Once a preset number is known, it can be entered directly through the front panel.

If the number of the preset is unknown, the Browse soft button can be used to select a preset by name.

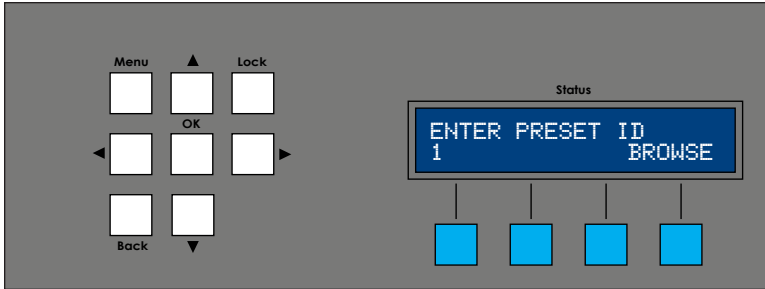

See [Selecting Presets \(page 93\)](#) for more information on selecting presets using the front panel.

10. To create additional *group* presets, repeat steps 3 - 7.
11. To edit a preset, click the **Preview / Edit** button under the desired preset.

Creating Quick Presets

Each *user* or *group* preset can be assigned a *quick preset*. The quick preset provides a one-button solution to accessing a *user* or *group* preset. The Matrix Controller provides a total of eight *quick presets*, which can be used across all *groups*. *Quick presets* can be split between multiple *groups* or they can be used within a single *group*. *Quick presets* can only be created under the front panel user or a user with *Slave access level*. *Quick presets* are accessed from the IR remote control.

1. Login to the web interface as **front panel** or as a user with **Slave access level**.
2. Click the **Main** tab.
3. Click the desired *group* button where the *quick preset* will be assigned.
4. Create a *user* or *group* preset but complete the following steps before saving the preset. See [Creating User Presets \(page 63\)](#) or [Creating Group Presets \(page 66\)](#) for more information.

If a user or group preset already exists, see [Editing Quick Presets \(page 72\)](#) for more information.

5. Click the **Quick Presets** drop-down list, next to the name of the preset and select the desired preset (1 - 8). If this drop-down list is not shown, verify that you are logged in as **front panel**.

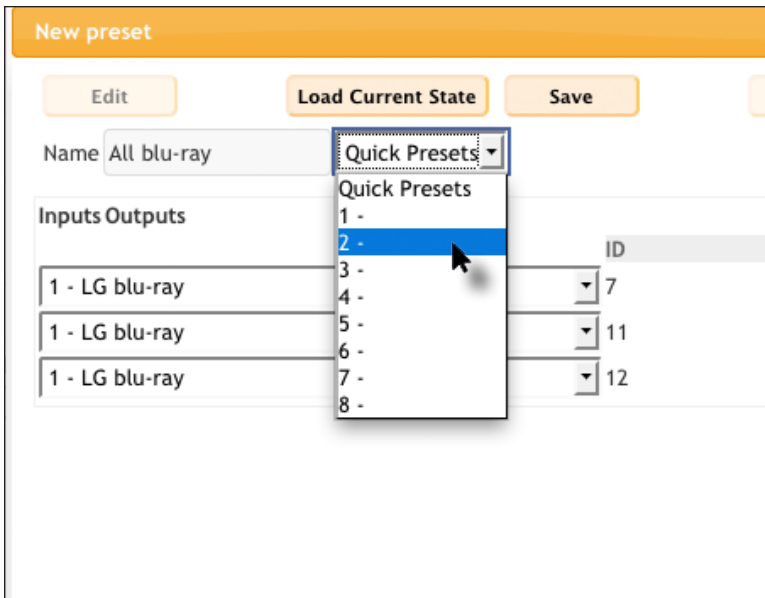

6. Click the **Save** button.
7. The **Preset** dialog will be displayed.
 - ▶ Click the **Route** button to instantly execute this preset.
 - ▶ Click the **Edit** button to edit the preset.
 - ▶ Click the **Delete** button to delete the preset.
 - ▶ Click the **Cancel** button to return to the **Main** tab.

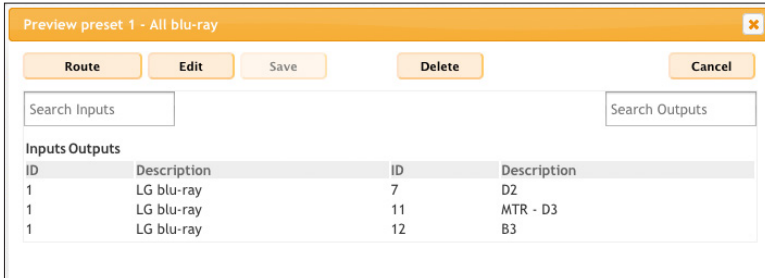

Note that when a quick preset is created, the *quick preset* number may not be the same as the *preset* number. In the example, above, we created **preset 1**. However, when we created the *quick preset*, we assigned it **quick preset 2**.

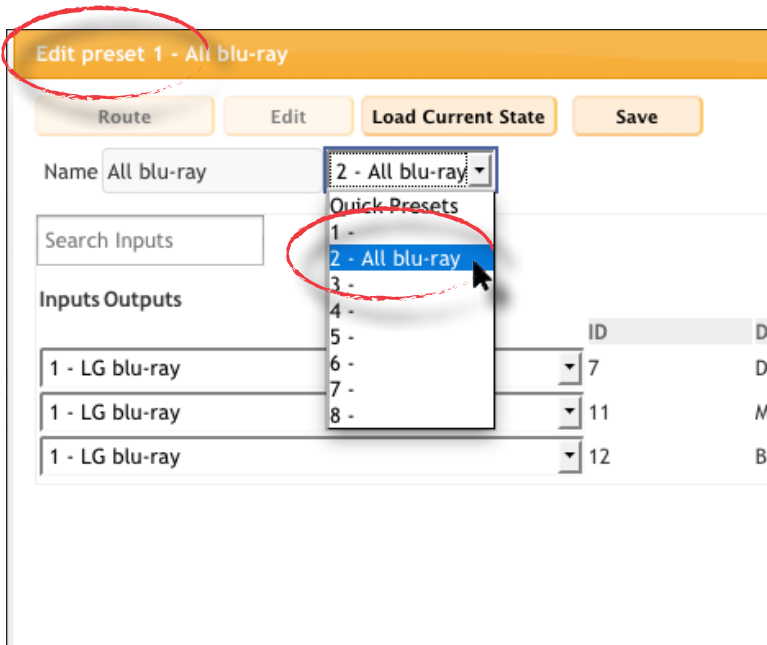

Editing Quick Presets

The number assignment for a *quick preset* (*user* or *group*) can be changed, if desired. In addition, the *preset Name* and *Inputs* can be changed as well. In order for a *quick preset* to be edited, a *user* or *group preset* must exist.

1. Login to the web interface as **front panel**.
2. Click the **Main** tab.
3. Click the desired *group* button to display the available inputs and outputs.
4. Click the **Preview / Edit** button under the *preset* (*user* or *group*) to be edited.

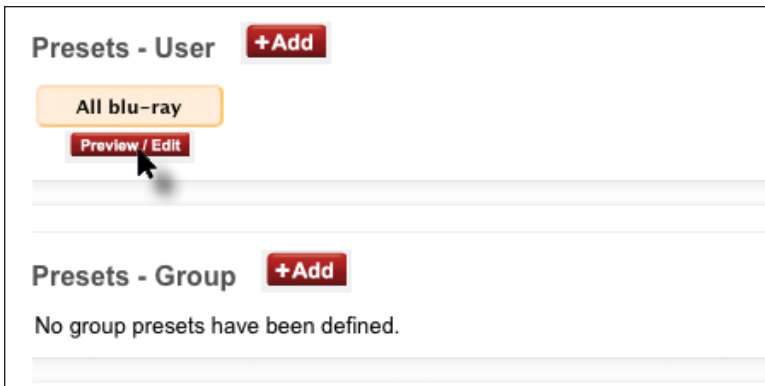

5. The **Preview preset** dialog will be displayed.
6. Click the **Edit** button.

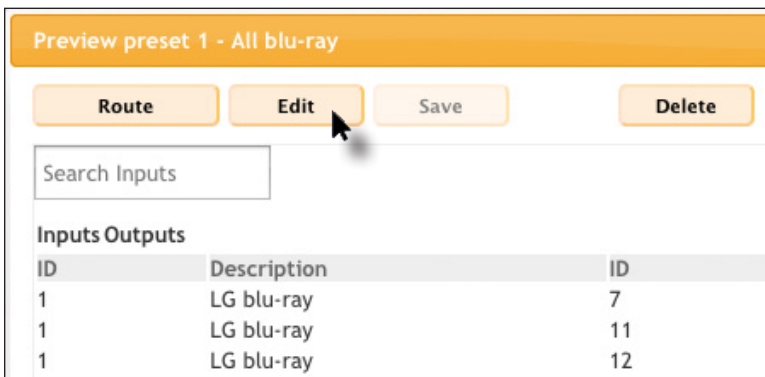

7. The **Edit preset** dialog will be displayed.
8. Click the drop-down list and select the desired preset.

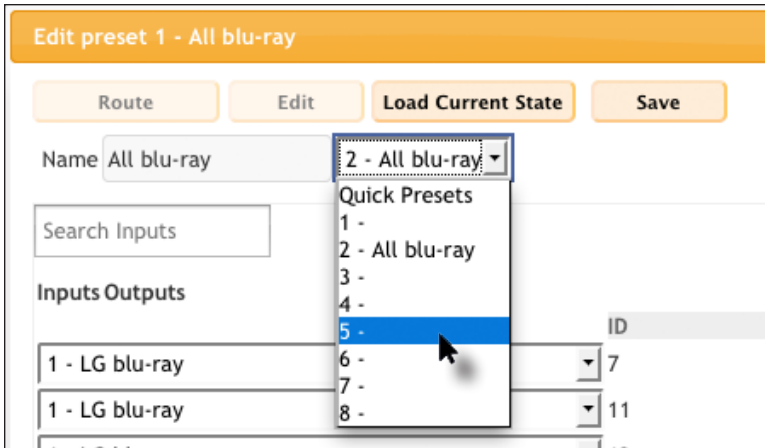

9. Click the **Save** button to save the changes.

If an existing quick preset is selected from the drop-down list, then saved, the following message box will be displayed:

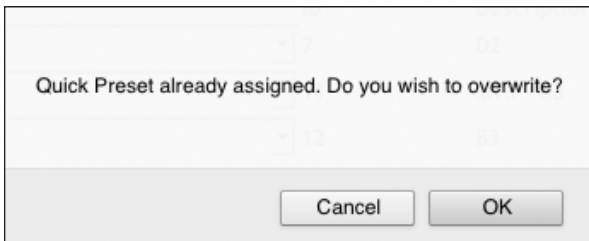

- ▶ Click the **OK** button to overwrite the existing quick preset.
- ▶ Click the **Cancel** button to cancel the operation and select another *quick preset* from the drop-down list.

Using Quick Presets

Quick presets can only be accessed from the IR remote control. For information on creating *quick presets*, see [Creating Quick Presets \(page 70\)](#).

1. From any screen, press the desired *quick preset* from the **Quick Presets** section on the IR remote control.

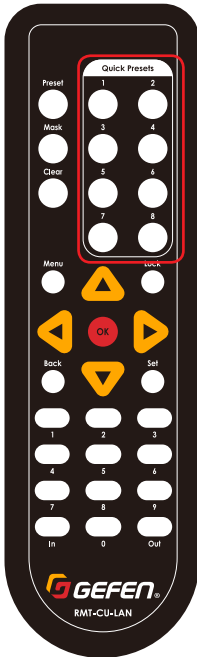

2. Press the desired *quick preset* button (1 - 8).
3. Once the quick preset has been applied, the following screen will be displayed.

```
ROUTING QUICK PRESET
2 ALL BLU-RAY
```

In the example, above, the bottom line reads “2 All Blu-Ray”. Here, “2” is the *quick preset* number that was assigned to the *user preset* called “All Blu-Ray”

4. The *quick preset* is now applied.
5. After a few moments, the previous screen which was displayed, will be shown.

Accessing the Menu System

1. After connecting power to the Matrix Controller, the following message will appear in the **Status** window:

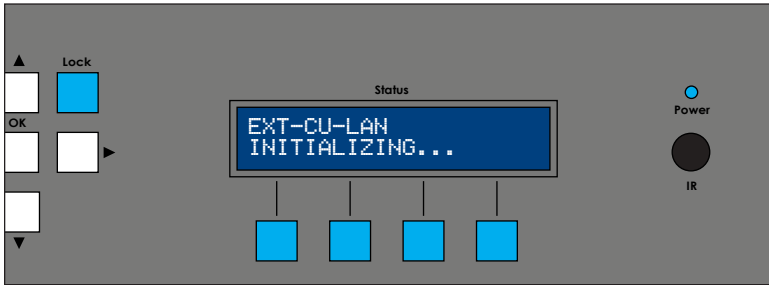

2. After a few moments, the passcode screen will be displayed. This screen is also displayed after about 1 minute of inactivity, for security purposes.



3. Use the numerical keypad to enter the passcode. The default passcode is 123456. To change the passcode, refer to [Creating Groups](#) (page 38).

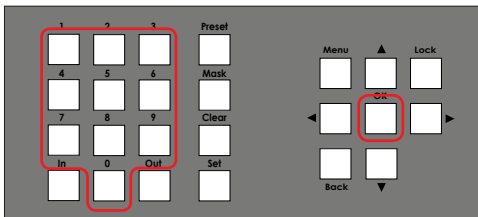

OR

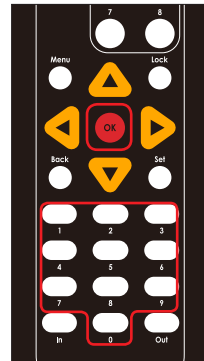

4. Press the **OK** button.
5. The *standby* screen will be displayed:

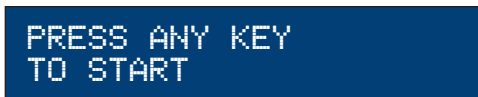

- Press the **Menu** button.
- The **Menu** button, on the front panel, will glow solid blue and the **Network** menu will be displayed.

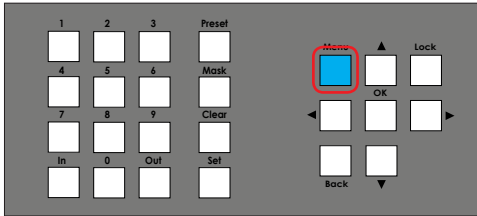

OR

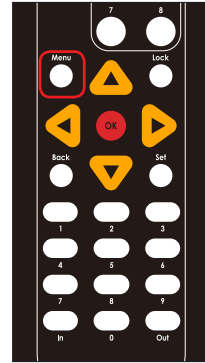

- The menu system contains two menus: **Network** and **System**. Press the ▲ or ▼ buttons to select either menu system.

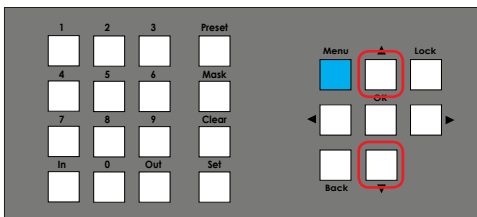

OR

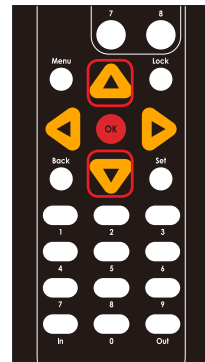

- Once the desired menu is selected, press the **OK** button to enter the menu system. Refer to the following pages for details on each menu system option.

10. To return to the *standby screen*, press the **Back** button.

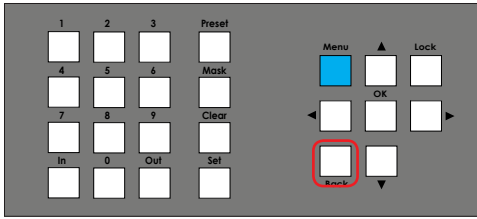

OR

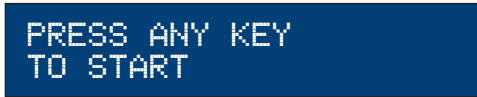
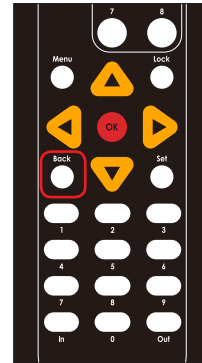

Routing Inputs to Outputs

- From the *standby screen*, press the **In** button. See [Accessing the Menu System](#) (page 75) for information on how to display the *standby screen*.

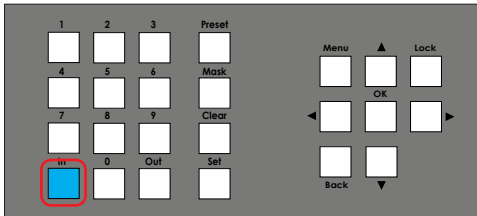

OR

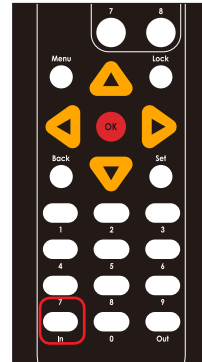

- The four buttons under the **Status** window will glow solid blue and the *group* selection screen will be displayed. The currently selected *group* is displayed in the top row.

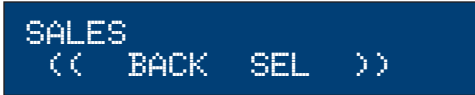

- Select the desired *group* using the << or >> soft buttons on the front panel or the ◀ or ▶ buttons on the IR remote control.

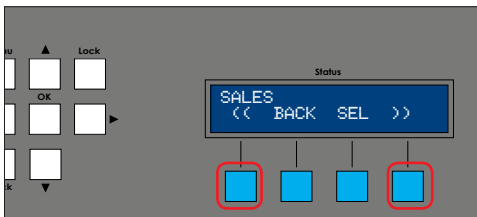

OR

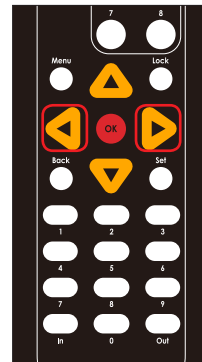

4. Once the desired *group* is selected, press the **SEL** button. To return to the previous screen, press the **BACK** button
5. The following screen will be displayed:

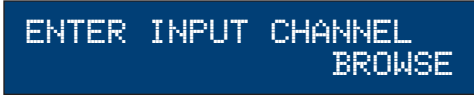

6. Select the desired input within the *group*. There are two methods:

- ▶ Select by Input Channel
 - a. Use the numbers on the keypad to enter the number. If you make a mistake, press the **Clear** button to erase the entry.
 - b. Press the **OK** button to accept the selection.

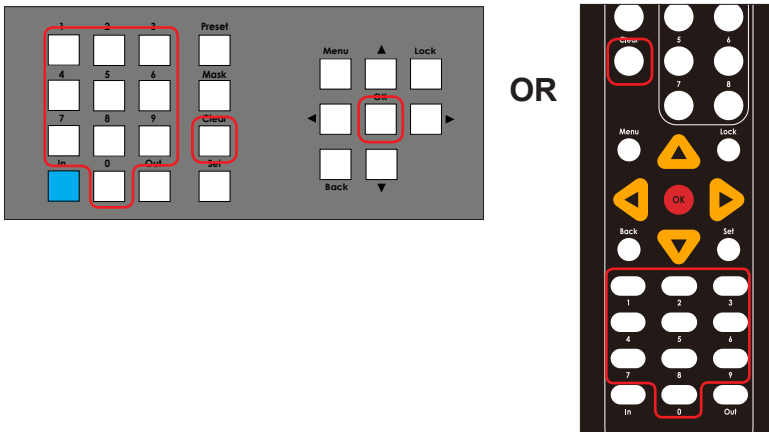

- ▶ Browse by Input
 - a. The second option is to press the **BROWSE** button on the front panel.

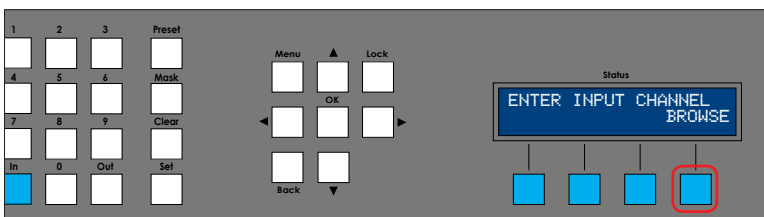

- b. Use the << or >> soft buttons on the front panel or the ◀ or ▶ buttons on the IR remote control to select the desired input. Each input will be listed by description, as shown in the example below.



- c. Press the **SEL** button on the front panel or the **OK** button on the IR remote control to select the currently displayed source.

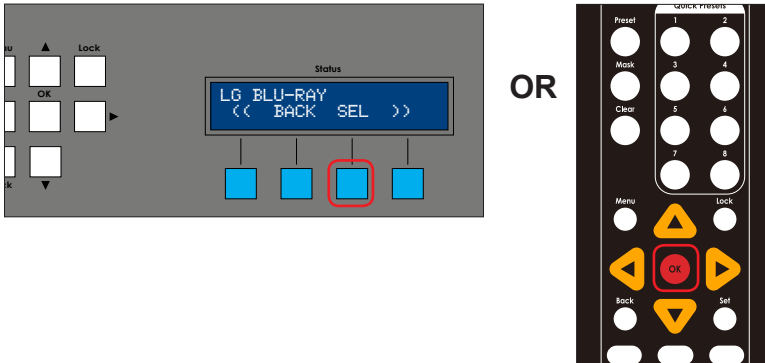

- d. The output screen will be displayed.



7. Select the output by one of the following methods:

► Select by Output Channel

- a. Use the numeric keypad to enter the Output ID. If you make a mistake, press the **Clear** button to erase the entry. Press the **OK** button to accept the selection.

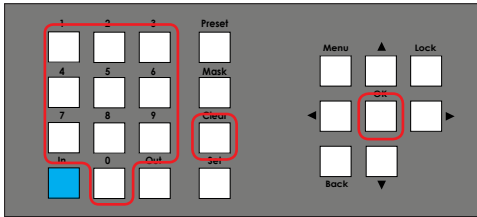

OR

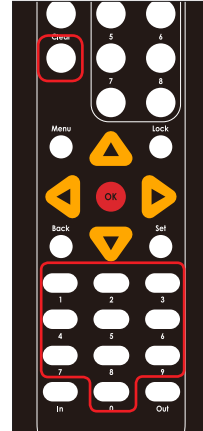

► Browse by Output

- a. Press the **BROWSE** button on the front panel.
- b. The output selection screen will be displayed:



- c. Use the ◀ or ▶ buttons to select the desired output.
- d. Press the **SEL** button on the front panel or the **OK** button on the IR remote control to select the current output.

Press the **BACK** on the front panel or on the IR remote control to return to the previous screen.

8. The *route details* screen will be displayed.



From this screen, you can:

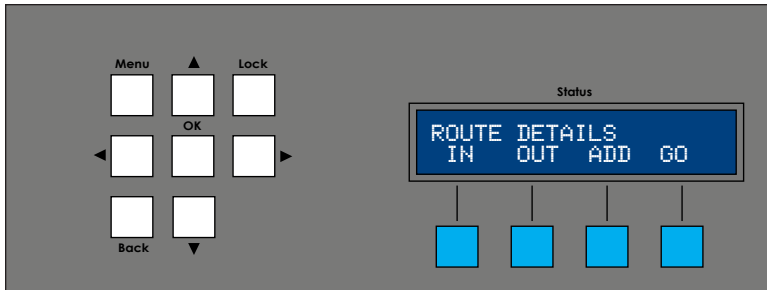

- a. Press the **IN** button to display the selected input.

```

LG BLU-RAY
BACK
  
```

- b. Press the **OUT** button to display the selected output(s).

```

MTR-D3
BACK (< >)
  
```

- c. Press the **ADD** button to add more outputs. See [Adding Outputs \(page 89\)](#) for more information.
- d. Press the **GO** button to initiate the routing process.

```

INITIATE ROUTES
  
```

9. Press the **Back** button to exit the *route details* screen.

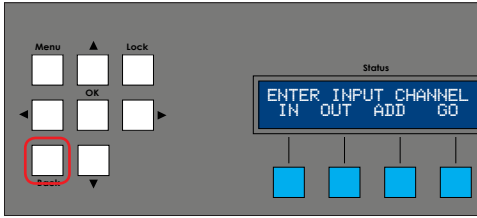

OR

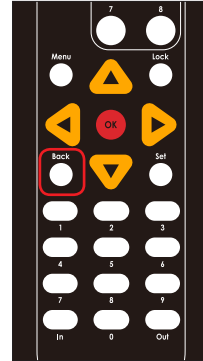

Routing Outputs to Inputs

Normally, when routing, the input is selected first, followed by the desired output(s). However, the Matrix Controller also provides the option to select the output(s) first, followed by the input.

1. From the *standby screen*, press the **Out** button. See [Accessing the Menu System \(page 75\)](#) for information on how to display the *standby screen*.

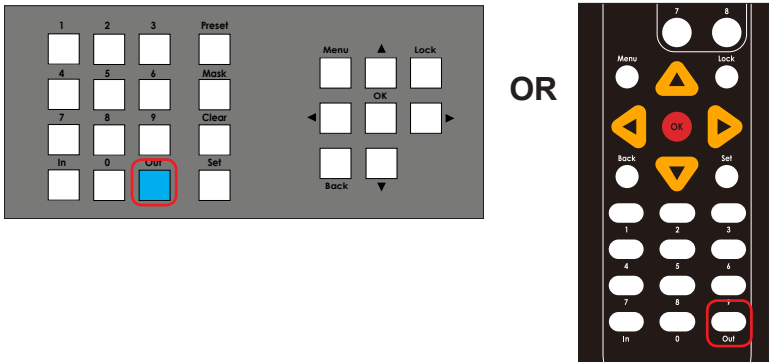

2. The **Out** button and the four buttons under the **Status** window will glow solid blue.
3. The *group* selection screen will be displayed. The currently selected *group* is displayed in the top row.

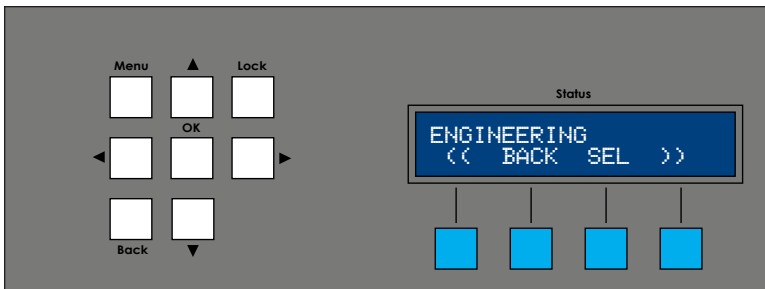

4. Press the << or >> soft buttons on the front panel or the ◀ or ▶ buttons on the IR remote control to list the available *groups*.

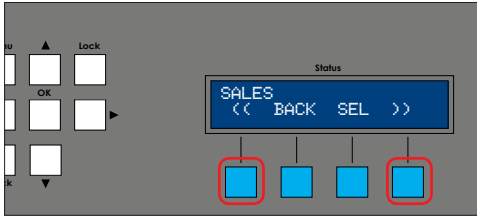

OR

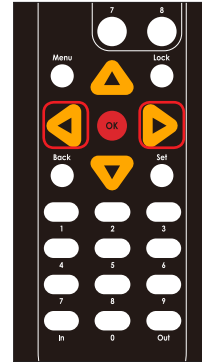

5. Press the **SEL** button on the front panel or the **OK** button on the IR remote control to select the displayed *group*. To return to the previous screen, press the **BACK** button on the front panel or on the IR remote control.

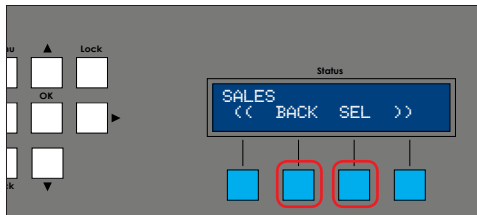

OR

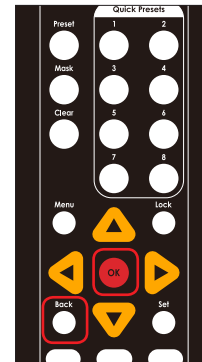

6. The following screen will be displayed:



7. Select the desired output within the *group*. There are two methods:

- ▶ Select by Output Channel
 - a. Use the numbers on the keypad to enter the number. If you make a mistake, press the **Clear** button to erase the entry.
 - b. Press the **OK** button to accept the selection.

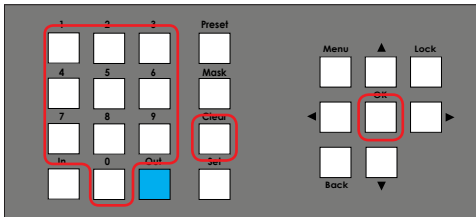

OR

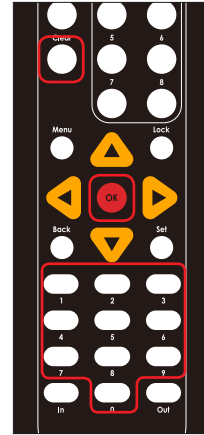

▶ Browse by Output

- Press the **BROWSE** button on the front panel and select the output from a list.

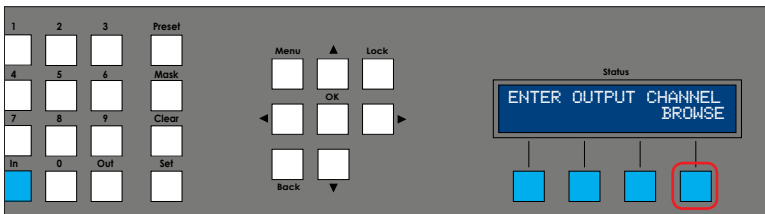

7. Select the desired output within the *group*. There are two methods:
 - a. The output selection screen will be displayed:



- b. Press the ◀ or ▶ buttons to select the desired input.
 - c. Press the **SEL** button on the front panel of the **OK** button on the IR remote control to select the current input.

Press the **BACK** button on the front panel or on the IR remote control to return to the previous screen.

8. The *route details* screen will be displayed. From this screen, you can:

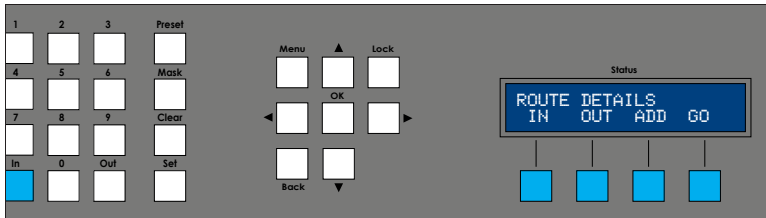

- ▶ Press the **GO** button to initiate the routing process.



- ▶ Press the **IN** button to display the selected input.



- ▶ Press the **OUT** button to display the selected output(s).



- d. Press the **ADD** button to add more outputs. See [Adding Outputs \(page 89\)](#) for more information.
5. Press the **Back** button on the front panel or on the IR remote control to exit the *route details* screen.

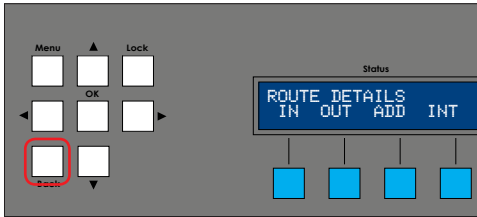

OR

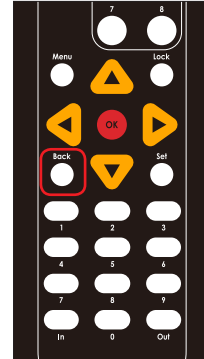

Adding Outputs

In order to add outputs, at least one input must be routed to an output within a *group*. See [Routing Inputs to Outputs \(page 78\)](#) for more information.

1. From the *route details* screen, press the **Add** button on the front panel.

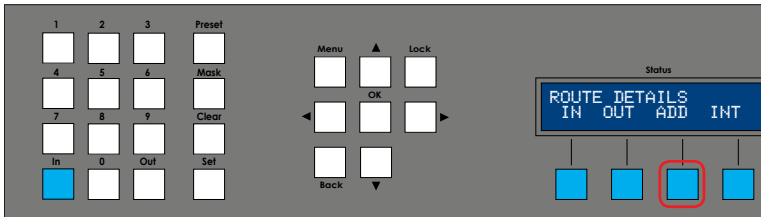

2. The add outputs screen will be displayed.

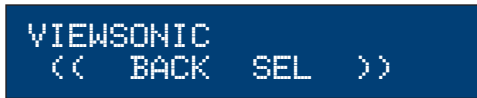

3. Use the ◀ or ▶ buttons on the front panel or on the IR remote control to scroll through each of the available outputs.

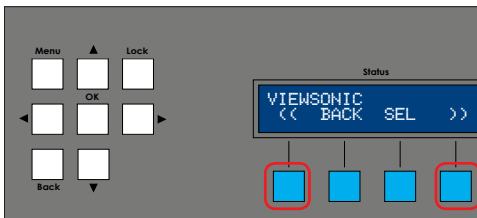

OR

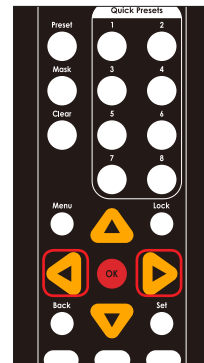

If no other outputs are available, then the following screen will be displayed.

NO REMAINING OUTPUTS
BACK

If this is the case, press the **BACK** button on the front panel or on the IR remote control to return to the *route details* screen.

4. Once the desired output is selected, press the **SEL** button on the front panel or the **OK** button on the IR remote control.
5. Repeat steps 1 - 4 to continue adding outputs.
6. Press the **BACK** button on the front panel or on the IR remote control.



7. Press the **GO** button on the front panel to initialize the new routing configuration.

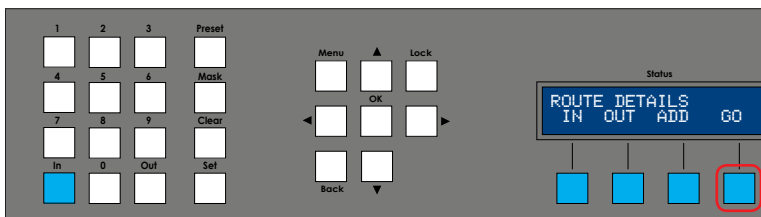

Masking an Output

The Matrix Controller allows selected outputs to be masked. When an output is masked, the signal is not displayed on the output. To *block* the input signal, see [Blocking Inputs](#) (page 54).

1. From any screen, press the **Mask** button. The **Mask** button will glow solid blue.
2. The *output selection* screen will be displayed and the four buttons under the **Status** window will glow solid blue.

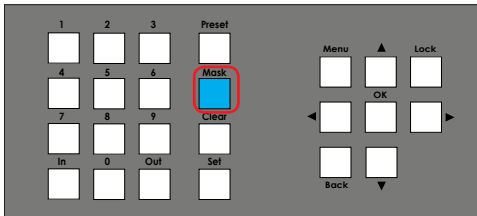

OR

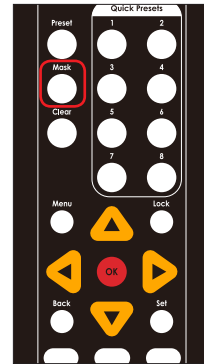

3. Use the ◀ or ▶ buttons to select the desired group.

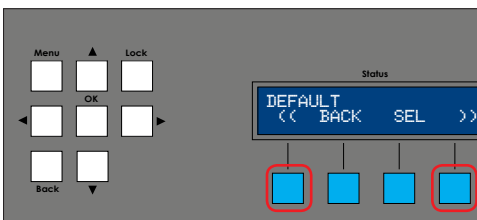

OR

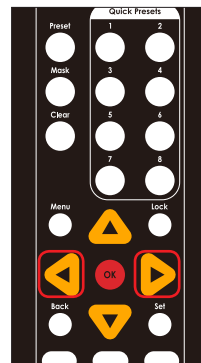

- Press the **SEL** soft button on the front panel or press the **OK** button on the IR remote control.

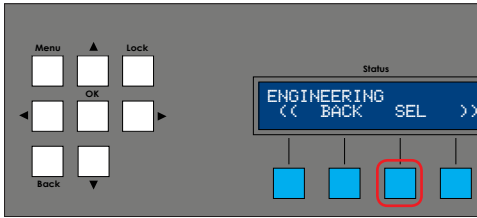

OR

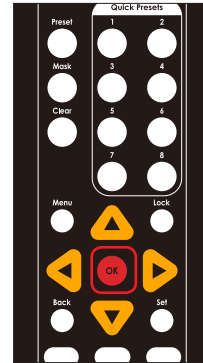

- Use the numeric buttons to enter the desired output to be masked. In the example below, we will mask output 2, by entering the number 2.

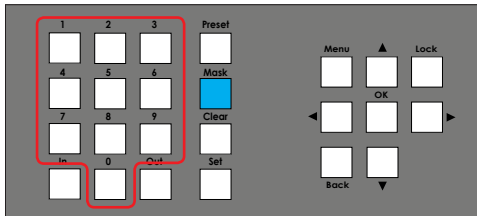

OR

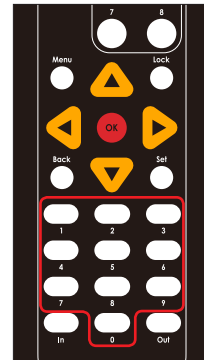

- Press the **OK** button to execute the masking process. The masking process will be completed once the following screen is displayed:



- To mask additional outputs, repeat steps 1 - 6. To *unmask* an output, repeat steps 1 - 6 and enter the number of the output that is currently masked.

Selecting Presets

Before using the front panel to select presets, use the built-in Web interface to add and configure presets. See [Using Presets \(page 63\)](#) for more information. To access routing presets, use the following procedure.

1. From the *standby screen*, press the **Presets** button. See [Accessing the Menu System \(page 75\)](#) for information on how to display the *standby screen*.

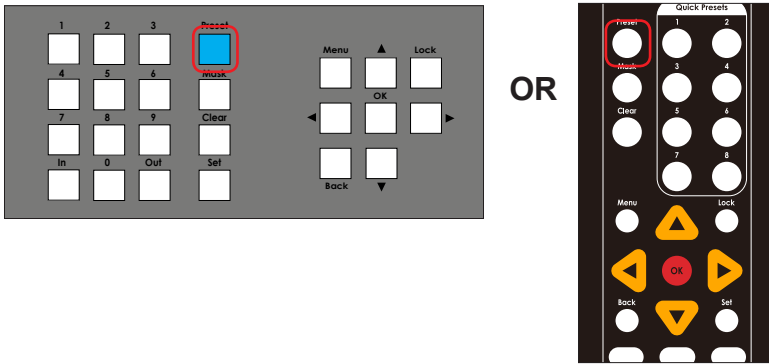

2. The *Enter Preset ID* screen will be displayed:



3. Select the desired preset. There are two methods:
 - ▶ Select by Preset ID
 - a. Use the numeric keypad to enter the Preset ID. If you make a mistake, press the **Clear** button to erase the entry. Press the **OK** button to accept the selection.

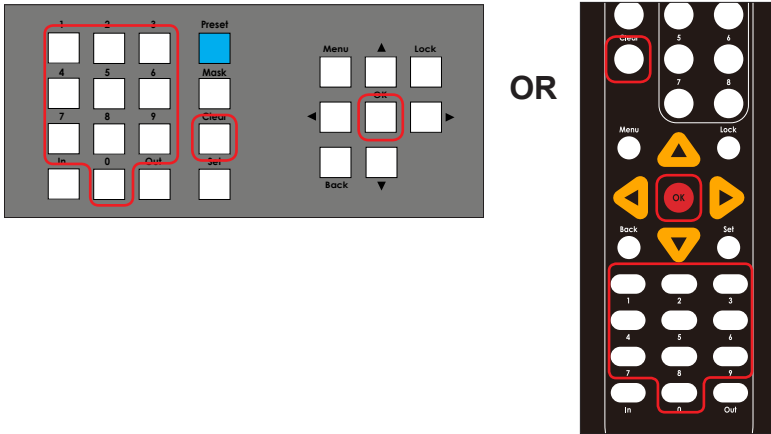

- b. Press the **OK** button to accept the selection.
- c. Once the preset is selected, the *initiate preset* screen will be displayed, indicating that the preset has been selected.

INITIATE
PRESET

- Browse by Preset Name
 - a. Press the **BROWSE** button on the front panel.

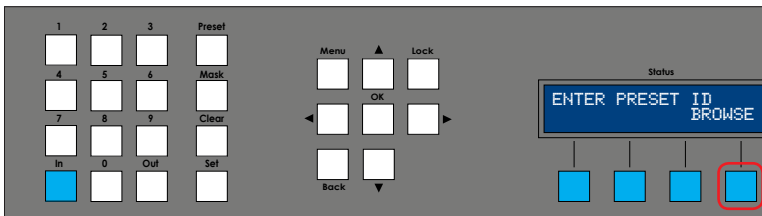

- b. Use the ◀ or ▶ buttons to list the available presets. Each preset will be listed by the name that it was given in the Web interface.

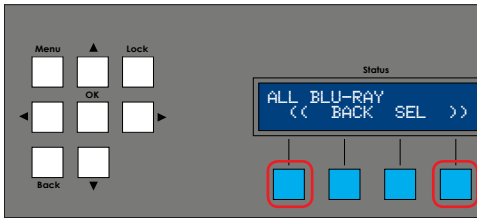

OR

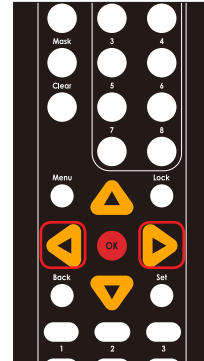

- c. Press the **SEL** button on the front panel or the **OK** button on the IR remote control to select the desired preset.

Press the **BACK** button on the front panel or on the IR remote control to return to the *Enter Preset ID* screen.

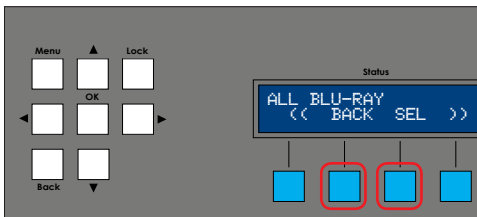

OR

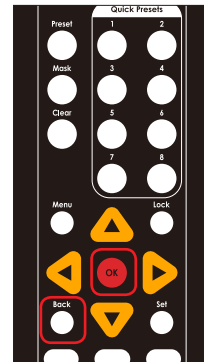

- d. Once the preset is selected, the *initiate preset* screen will be displayed, indicating that the preset has been selected.



INITIATE
PRESET

5. After a few moments, the *route details* screen will be displayed.

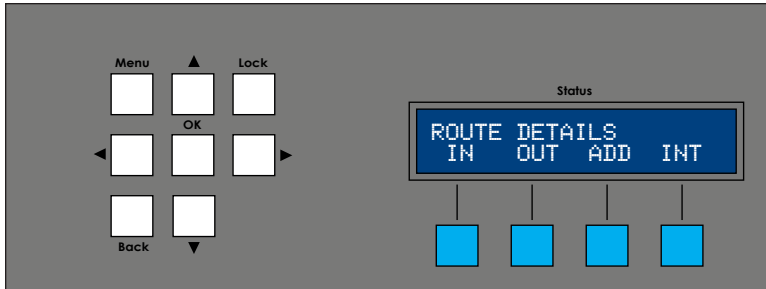

Setting the Network Mode

- From the *standby screen*, press the **Menu** button. See [Accessing the Menu System \(page 75\)](#) for information on how to display the *standby screen*.

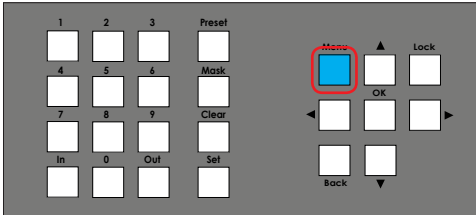

OR

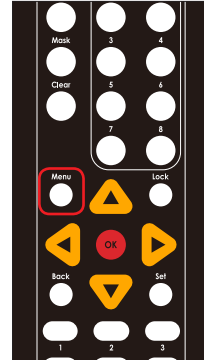

- The **Network** menu will be displayed.



- Press the **OK** button to enter the **Network Menu** menu.

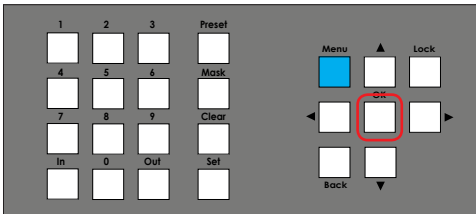

OR

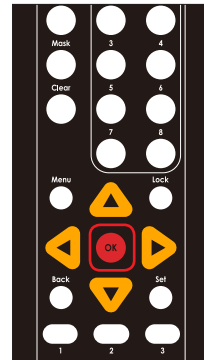

- Press the **OK** button again to change the network mode.

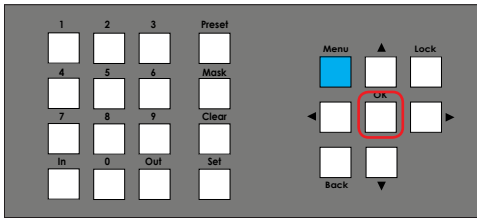

OR

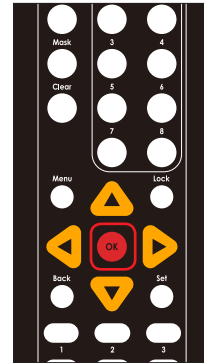

NETWORK MODE: (EDIT)
SEPARATE

5. Press the ▲ or ▼ buttons to select either **Separate** or **Combined**. In the example, below, we have selected **Combined**.

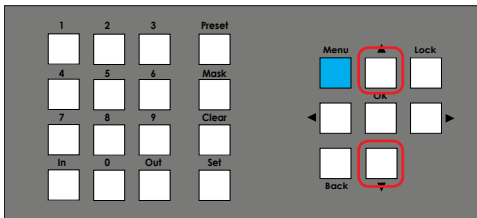

OR

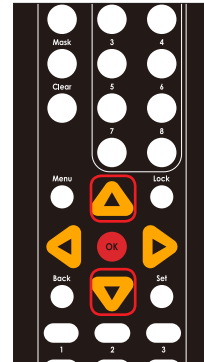

NETWORK MODE: (EDIT)
COMBINED

6. Press the **OK** button to save the change.
7. The following screen will be displayed:

PLEASE REBOOT UNIT
TO APPLY CHANGES

8. Reboot the unit to apply the changes. To ignore the changes and return to the *standby screen*, continuously press and release the **Back** button.

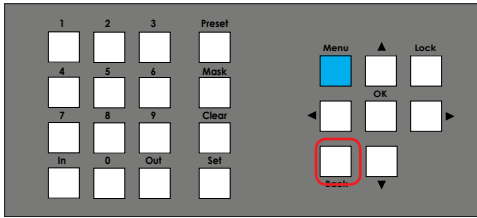

OR

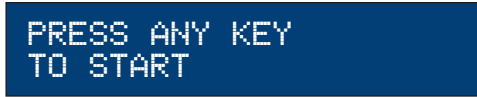
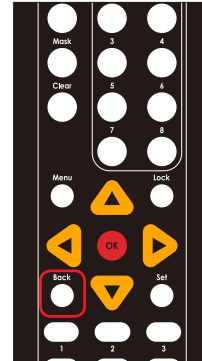

Control IP Settings

The Control IP Settings menu allows you to set the IP mode (Static or DHCP), IP address, subnet mask, gateway address, and HTTP listening port of the Matrix Controller.

1. From the *standby screen*, press the **Menu** button. See [Accessing the Menu System \(page 75\)](#) for information on how to display the *standby screen*.
2. The **Network** menu will be displayed.

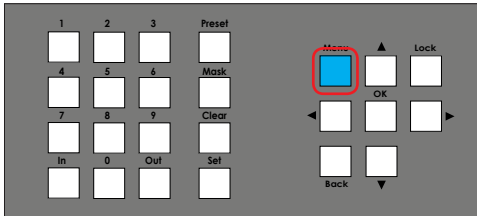

OR

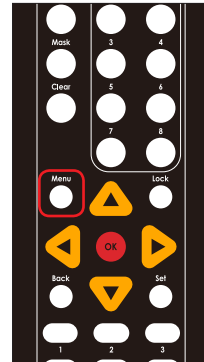

3. Press the **OK** button to enter the **Network Menu** menu.

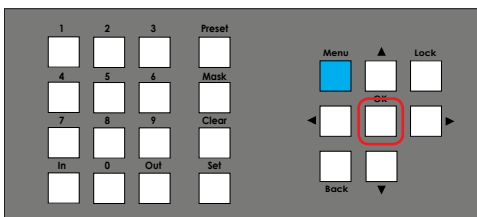

OR

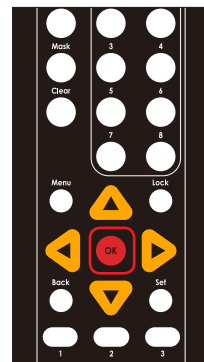

4. Press the ▲ or ▼ buttons to select **Control IP Settings**.

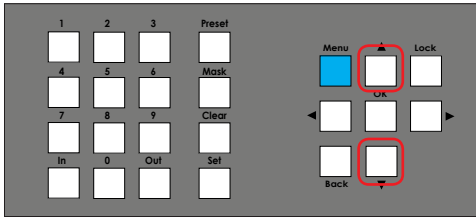

OR

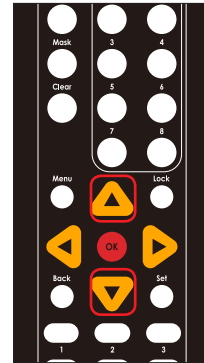

5. Press the **OK** button to enter the **Control IP Settings** menu. The current IP mode setting will be displayed.



6. Press the **OK** button, again, to edit the current setting.



7. Press the ▲ or ▼ buttons to select either **Static** or **DHCP**. In this example, we will leave the IP mode setting as **Static**. Consult your network administrator, if necessary, for required network configuration settings.



8. Press the **OK** button to save the current changes.
9. The following screen will be displayed, momentarily:

PLEASE REBOOT UNIT
TO APPLY CHANGES



Important

Any time a setting has been changed, the "please reboot unit" message will be displayed. However, it is not required to reboot the unit until all desired changes have been made. All changed settings are "saved" but will *only* be applied once the unit is rebooted.

10. Continue by pressing the **▲** or **▼** buttons to select the **IP Address** setting. The current IP address will be displayed.

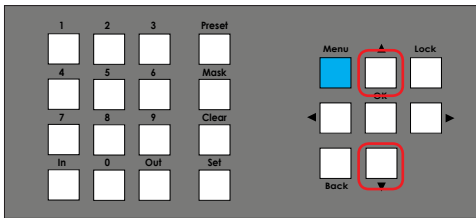

OR

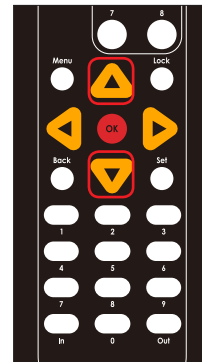

IP ADDRESS:
192.168.1.74

11. Press the **OK** button to change the setting. The first digit of the IP address will flash.

IP ADDRESS:
_92.168.001.074

12. Use the numeric keypad to enter the desired IP address.

If a one or more digits in the IP address is less than three digits in length, then preceding zeros must be used to pad the value. For example, if one of the numbers is 10, then you would enter 010 on the keypad. If the number is 5, then you would enter 005.

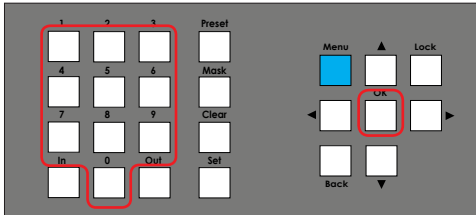

OR

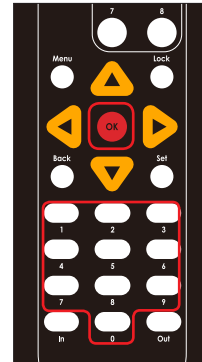

13. The cursor will automatically advance to the next digit in the IP address. If an error is made, use the ◀ or ▶ to move backward or forward between each digit.
14. Press the **OK** button to save the change.



15. Press the ▲ or ▼ buttons to select the **Subnet Mask** setting. The subnet mask address will be displayed.

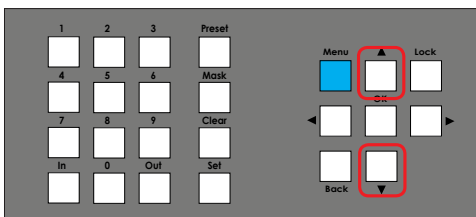

OR

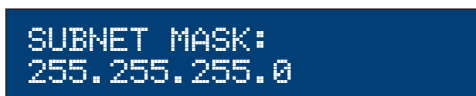
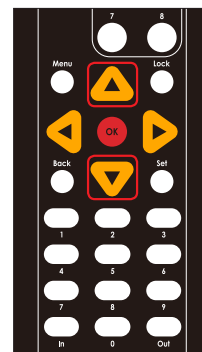

16. Press the **OK** button to edit the current selection. The first digit of the address will flash.



```
SUBNET MASK:
_55.255.255.000
```

17. Use the numeric keypad to enter the desired subnet mask.

If a one or more digits in the subnet mask is less than three digits in length, then preceding zeros must be used to pad the value. For example, if one of the numbers is 10, then you would enter 010 on the keypad. If the number is 5, then you would enter 005.

The cursor will automatically advance to the next digit in the subnet mask. If an error is made, use the ◀ or ▶ to move backward or forward between each digit.

18. Press the **OK** button to save the change. For this example, we will leave the subnet mask at 255.255.255.0.



```
SUBNET MASK:
255.255.255.0
```

19. Press the ▲ or ▼ buttons to select the **Gateway** setting. The gateway address will be displayed.



```
GATEWAY
192.168.1.1
```

20. Press the **OK** button to change the setting. The first digit of the gateway address will flash.



```
GATEWAY
_92.168.1.1
```

21. Use the numeric keypad to enter the desired address.

If a one or more digits in the IP address is less than three digits in length, then preceding zeros must be used to pad the value. For example, if one of the numbers is 10, then you would enter 010 on the keypad. If the number is 5, then you would enter 005.

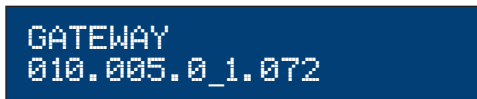
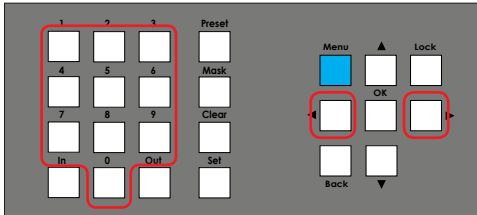

OR

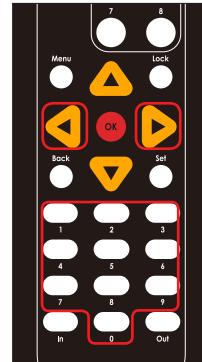

22. The cursor will automatically advance to the next digit in the IP address. If an error is made, use the ◀ or ▶ to move backward or forward between each digit.
23. Press the **OK** button to save the change.

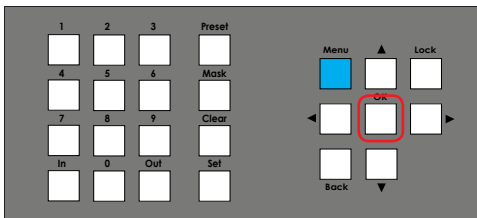

OR

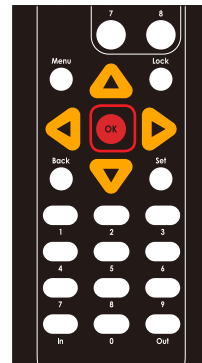

24. Press the ▲ or ▼ buttons to select the **HTTP Port** setting. The current HTTP listening port is displayed.



25. Press the **OK** button to edit the current port settings. The first available digit of the port number will flash.



26. Use the numeric keypad to enter the desired listening port.

The port range is 1 to 65535. Use preceding zeros to pad numbers less than 5 digits. For example, if the listening port is 80, then you would enter 00080.

If an error is made, use the ◀ or ▶ to move backward or forward between each digit.



27. Press the **OK** button to save the change.



28. To make changes to any of the IP settings, again, press the ▲ or ▼ buttons to select the desired menu, then press the **OK** button to make changes to the selected setting.
29. To return to the standby screen, consecutively press and release the **Back** button until the *standby screen* is displayed.

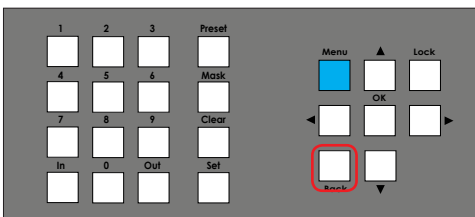

OR

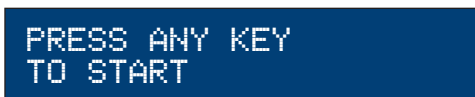
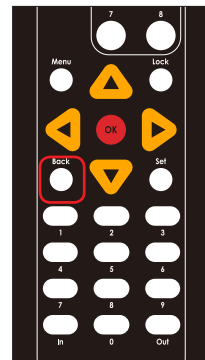

Video IP Settings

Video IP settings are only used in *separate mode* and allows you to access the Web interface using the Video IP address. Refer to [Separate Mode \(page 13\)](#) for more information on *separate mode*.

1. From the *standby screen*, press the **Menu** button. See [Accessing the Menu System \(page 75\)](#) for information on how to display the *standby screen*.
2. The **Network** menu will be displayed.

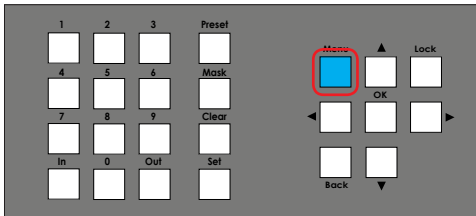

OR

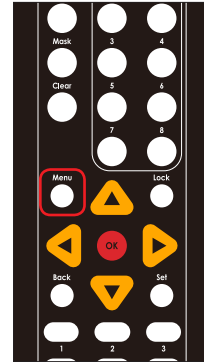

3. Press the **OK** button to enter the **Network Menu** menu.

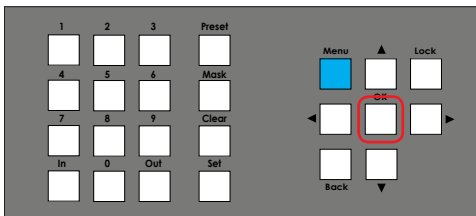

OR

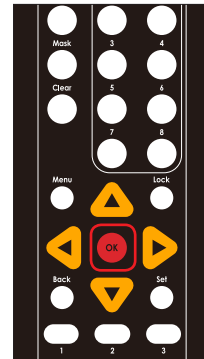

4. Press the ▲ or ▼ buttons to select **Video IP Settings**.

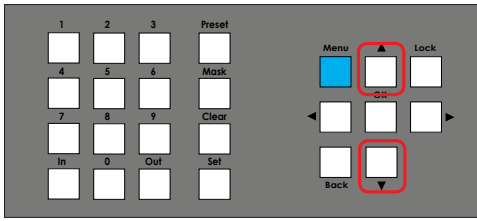

OR

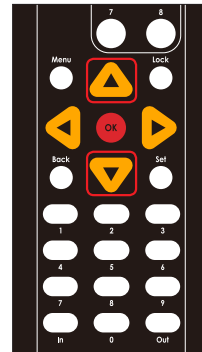

5. Press the **OK** button to enter the **Video IP Settings** menu. The current IP mode setting will be displayed.



The **IP Mode** for **Video IP Settings** cannot be changed. It will always be set to *static*.

6. Continue by pressing the ▲ or ▼ buttons to select the **IP Address** setting.



7. Press the **OK** button, again, to edit the current setting.

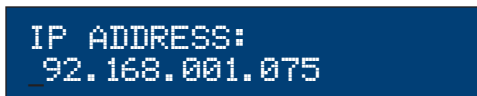

8. Use the numeric keypad to enter the desired IP address.

If a one or more digits in the IP address is less than three digits in length, then preceding zeros must be used to pad the value. For example, if one of the numbers is 10, then you would enter 010 on the keypad. If the number is 5, then you would enter 005.

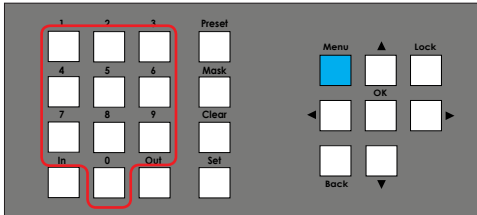

OR

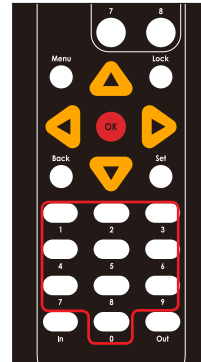

9. The cursor will automatically advance to the next digit in the IP address. If an error is made, use the ◀ or ▶ to move backward or forward between each digit.

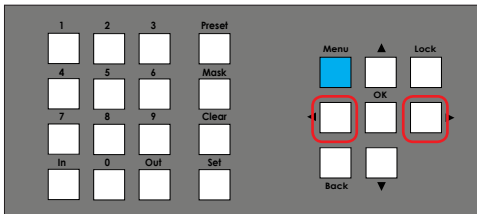

OR

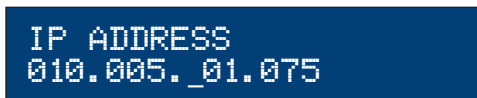
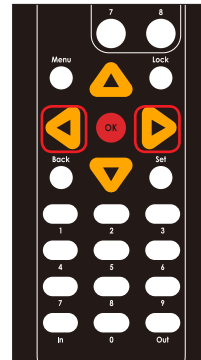

10. Press the **OK** button to save the current changes.
11. The following screen will be displayed, momentarily:

PLEASE REBOOT UNIT
TO APPLY CHANGES



Important

Any time a setting has been changed, the "please reboot unit" message will be displayed. However, it is not required to reboot the unit until all desired changes have been made. All changed settings are "saved" but will *only* be applied once the unit is rebooted.

12. Continue by pressing the **▲** or **▼** buttons to select the **Subnet Mask** setting. The subnet mask address will be displayed.

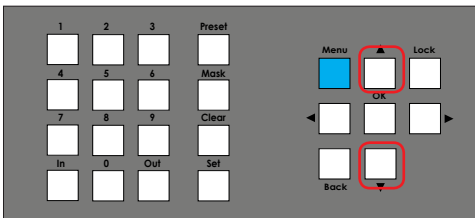

OR

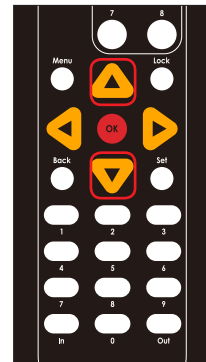

SUBNET MASK:
255.255.255.0

13. Press the **OK** button to change the setting. The first digit of the subnet mask will flash.

SUBNET MASK:
_55.255.0.000

14. Use the numeric keypad to enter the desired subnet mask address.

If a one or more digits in the address is less than three digits in length, then preceding zeros must be used to pad the value. For example, if one of the numbers is 10, then you would enter 010 on the keypad. If the number is 5, then you would enter 005.

The cursor will automatically advance to the next digit in the subnet mask. If an error is made, use the ◀ or ▶ to move backward or forward between each digit.

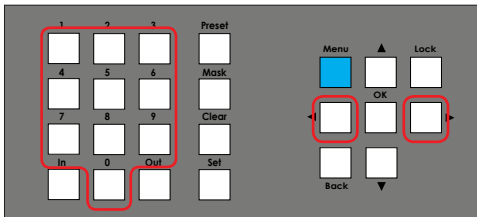

OR

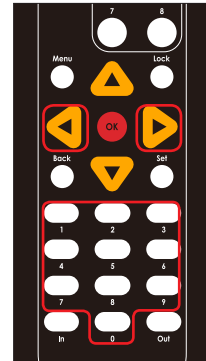

15. Press the **OK** button to save the change. For this example, we will leave the subnet mask set to 255.255.255.0.

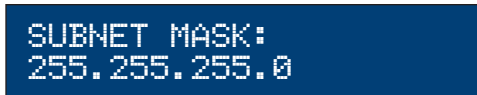

16. Press the ▲ or ▼ buttons to select the **Gateway** setting. The gateway address will be displayed.



17. Press the **OK** button to change the setting. The first digit of the gateway address will flash.

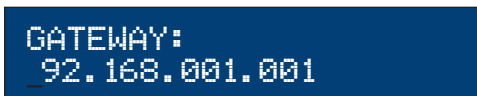

18. Use the numeric keypad to enter the desired address.

If one or more digits in the address is less than three digits in length, then preceding zeros must be used to pad the value. For example, if one of the numbers is 10, then you would enter 010 on the keypad. If the number is 5, then you would enter 005.

The cursor will automatically advance to the next digit in the gateway address. If an error is made, use the ◀ or ▶ to move backward or forward between each digit.

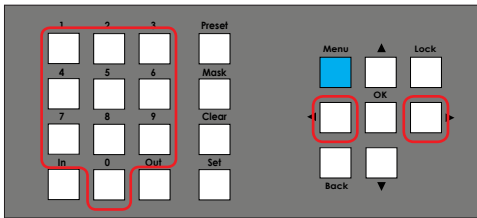

OR

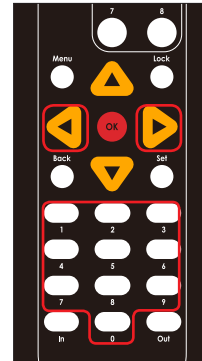

19. Press the **OK** button to save the changes.



Telnet / TCP Settings

1. From the *standby screen*, press the **Menu** button. See [Accessing the Menu System \(page 75\)](#) for information on how to display the *standby screen*.
2. The **Network** menu will be displayed.

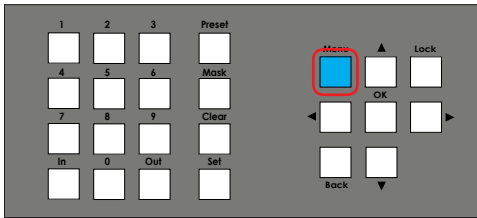

OR

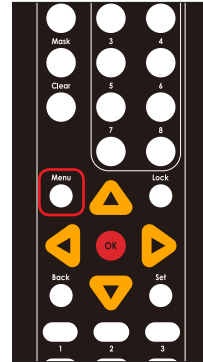

3. Press the **OK** button to enter the **Network Menu** menu.

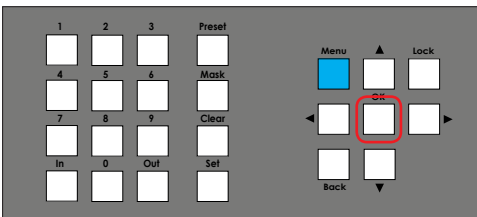

OR

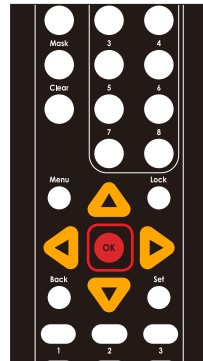

4. Press the ▲ or ▼ buttons to select **Telnet / TCP Settings**.

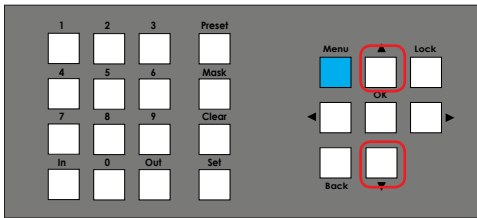

OR

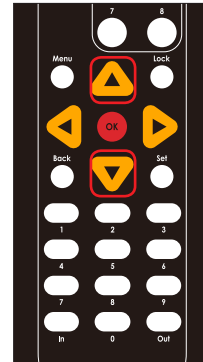

```
TELNET/TCP SETTINGS
```

5. Press the **OK** button to enter the menu.
6. The current TCP access status will be displayed.

```
TCP ACCESS:
ENABLED
```

7. Press the **OK** button, again, to edit the current setting.

```
TCP ACCESS: (EDIT)
ENABLED
```

8. Press the **▲** or **▼** buttons to select either **Enabled** or **Disabled**. This setting is used to allow or prevent TCP access. In this example, we will leave the TCP access setting as **Enabled**.
9. Press the **OK** button to save the current changes. For this example, we will leave the setting as **Enabled**.

```
TCP ACCESS:
ENABLED
```

10. Press the **▲** or **▼** buttons to select **TCP Port**.

```
TCP PORT:
23
```

11. Press the **OK** button to edit the current port setting. The first available digit in the port setting will flash.



12. Use the numeric keypad to enter the desired listening port.

The port range is 1 to 65535. Use preceding zeros to pad numbers less than 5 digits. For example, if the listening port is 23, then you would enter 00023.

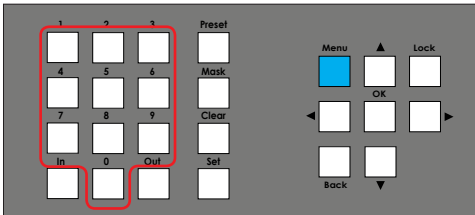

OR

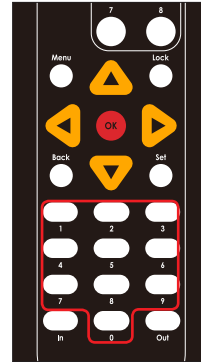

13. If an error is made, use the ◀ or ▶ to move backward or forward between each digit.

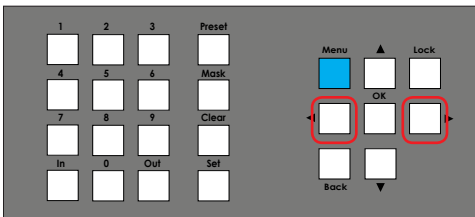

OR

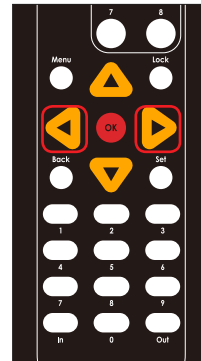

14. Press the **OK** button to save the change.

```
TCP PORT:
23
```

15. Press the ▲ or ▼ button to select the **Welcome Message** setting.

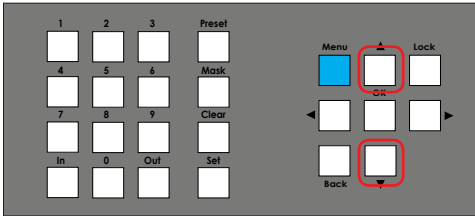

OR

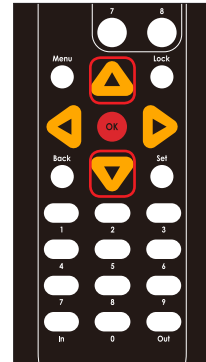

```
WELCOME MESSAGE:
DISABLED
```

16. Press the **OK** button to edit the current setting.

```
WELCOME MESSAGE: ED
DISABLED
```

17. Press the ▲ or ▼ buttons to select either **Enabled** or **Disabled**.

If this option is set to **Enabled**, then the following message will be displayed at the beginning of each Telnet session: "Welcome to EXT-CU-LAN Telnet". If set to **Disabled**, then no message will be displayed.

18. Press the **OK** button to save the changes.

```
WELCOME MESSAGE:
ENABLED
```

19. Press the ▲ or ▼ button to select the **Require Password** setting.

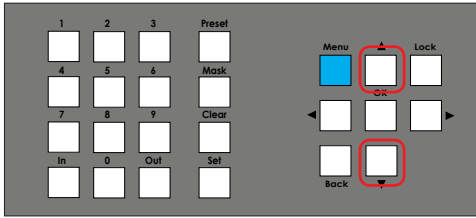

OR

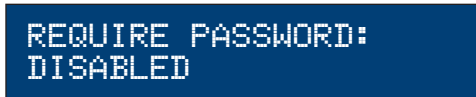
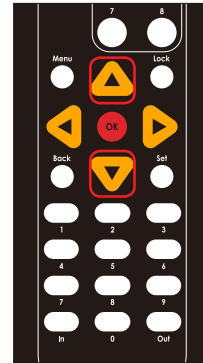

20. Press the **OK** button to edit the current selection.



21. Press the ▲ or ▼ buttons to select either **Enabled** or **Disabled**.

If this option is set to **Enabled**, then a password will be required to connect during a Telnet session. If set to **Disabled**, then no password will be required.

22. Press the **OK** button to save the changes.



UDP Settings

1. From the *standby screen*, press the **Menu** button. See [Accessing the Menu System \(page 75\)](#) for information on how to display the *standby screen*.
2. The **Network** menu will be displayed.

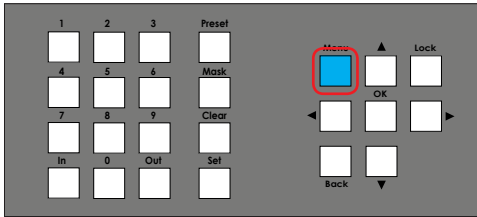

OR

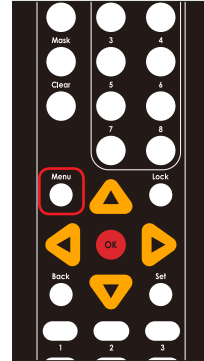

3. Press the **OK** button to enter the **Network Menu** menu.

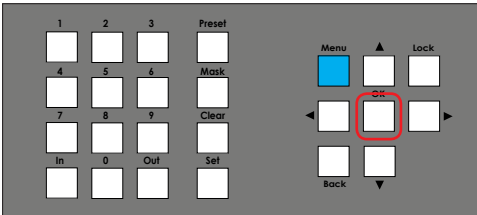

OR

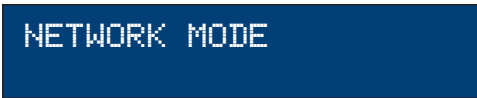
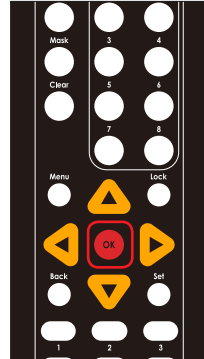

- Press the ▲ or ▼ buttons to select **UDP Settings**.

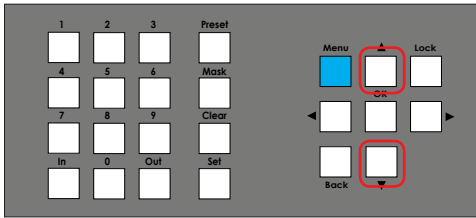

OR

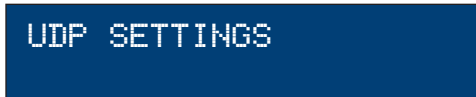
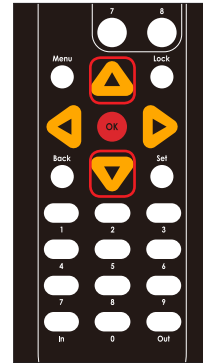

- Press the **OK** button to enter the menu.
- The current UDP access status will be displayed.

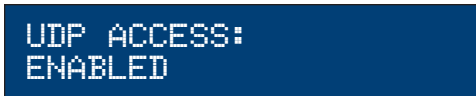

- Press the **OK** button, again, to edit the current setting.

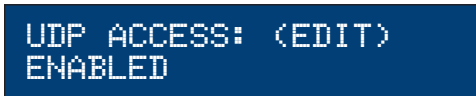

- Press the ▲ or ▼ buttons to select either **Enabled** or **Disabled**. This setting is used to allow or prevent UDP access. In this example, we will leave the IP mode setting as **Enabled**.
- Press the **OK** button to save the current changes. For this example, we will leave the setting as **Enabled**.

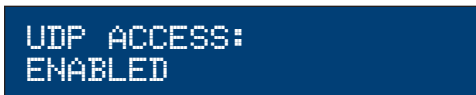

10. Press the ▲ or ▼ buttons to select **UDP Port**.

UDP PORT:
50007

11. Press the **OK** button to edit the current port setting. The first available digit in the port setting will flash.

UDP PORT: (EDIT)
_0007

12. Use the numeric keypad to enter the desired listening port.

The port range is 1 to 65535. Use preceding zeros to pad numbers less than 5 digits. For example, if the listening port is 23, then you would enter 00023.

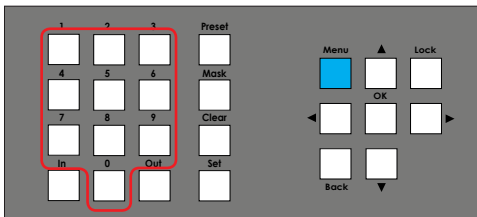

OR

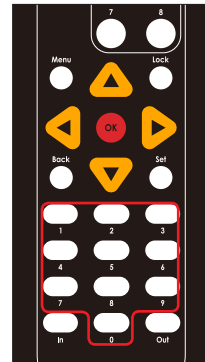

13. If an error is made, use the ◀ or ▶ to move backward or forward between each digit.

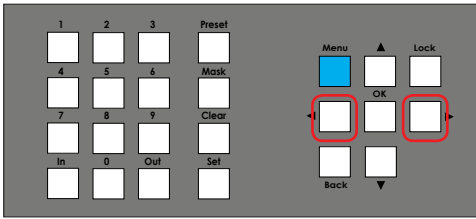

OR

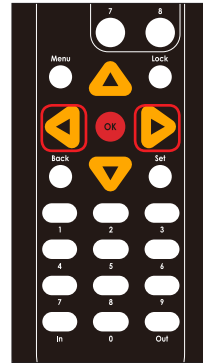

14. Press the **OK** button to save the change.
15. Press the ▲ or ▼ button to select the **Remote UDP Access** setting.

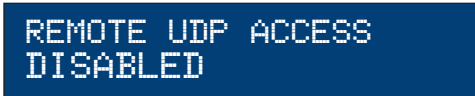

16. Press the **OK** button, again, to edit the setting.



17. Press the ▲ or ▼ buttons to select either **Enabled** or **Disabled**.

If this option is set to **Enabled**, then remote UDP access will be permitted. Otherwise, set this option to **Disabled** to prohibit access using the UDP protocol.

18. Press the **OK** button to save the changes.



19. Press the ▲ or ▼ button to select the **Remote UDP Address** setting.

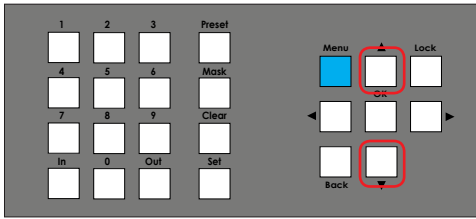

OR

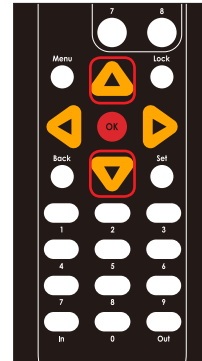

```
REMOTE UDP ADDRESS:
192.168.1.129
```

20. Press the **OK** button to edit the current selection. The first digit in the first digit of the address will flash.

```
REMOTE UDP ADDRESS:
_92.168.001.129
```

21. Use the numeric keypad to enter the desired address.

If a one or more digits in the address is less than three digits in length, then preceding zeros must be used to pad the value. For example, if one of the numbers is 10, then you would enter 010 on the keypad. If the number is 5, then you would enter 005.

22. If an error is made, use the ◀ or ▶ to move backward or forward between each digit.
23. Press the **OK** button to save the change.
24. Press the ▲ or ▼ button to select the **Remote UDP Port** setting.

```
REMOTE UDP PORT:
50008
```

25. Press the **OK** button to edit the current setting. The first available digit in the port setting will flash.



REMOTE UDP PORT: ED
_0008

26. Use the numeric keypad to enter the desired listening port.

The port range is 1 to 65535. Use preceding zeros to pad numbers less than 5 digits. For example, if the listening port is 23, then you would enter 00023.

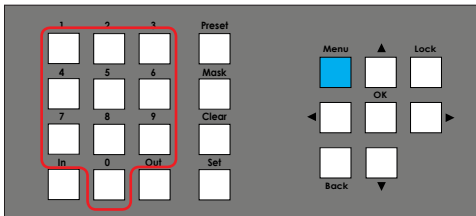

OR

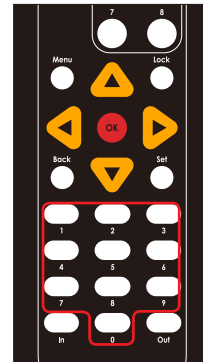

27. If an error is made, use the ◀ or ▶ to move backward or forward between each digit.



REMOTE UDP PORT: ED
5000_

28. Press the **OK** button to save the change.



REMOTE UDP PORT:
50008

Discovery Settings

The Discovery Settings menu allows the Matrix Controller to be “discovered” on a network using the Gefen Syner-G Software Suite.

1. From the *standby screen*, press the **Menu** button. See [Accessing the Menu System \(page 75\)](#) for information on how to display the *standby screen*.
2. The **Network** menu will be displayed.

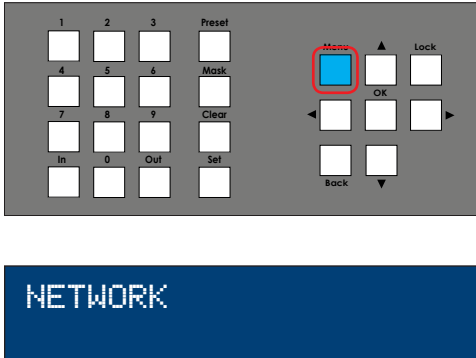

OR

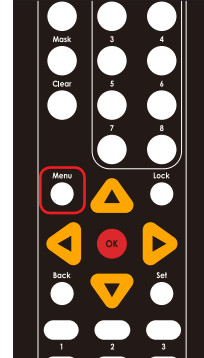

3. Press the **OK** button to enter the **Network Menu** menu.

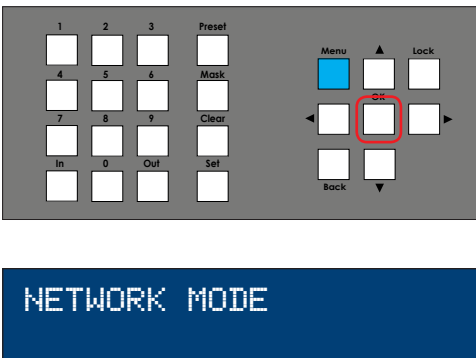

OR

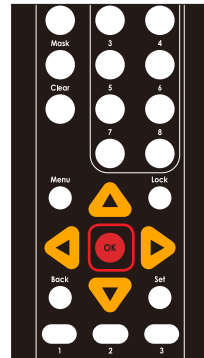

4. Press the ▲ or ▼ buttons to select **Discovery Settings**.

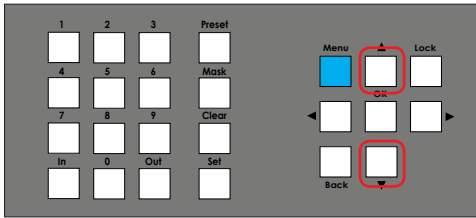

OR

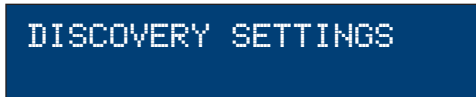
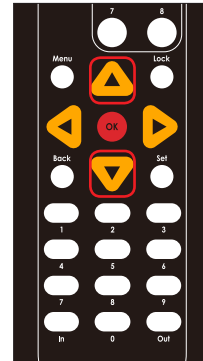

5. Press the **OK** button to enter the menu.
6. The current read / write status of the Discovery Service will be displayed.



7. Press the **OK** button, again, to edit the current setting.



8. Press the ▲ or ▼ buttons to select either **Read / Write**, **Read Only**, or **Disabled**.

- ▶ **Read / Write**
This mode will permit the discovery of the Matrix Controller on the network. In addition, the IP settings, description, and other settings for the Matrix Controller can be changed using the Syner-G Software Suite.
- ▶ **Read Only**
This mode only permits the discovery of the Matrix Controller on the network.
- ▶ **Disabled**
This mode prevents the discovery of the Matrix Controller on the network.

9. Press the **OK** button to save the current changes. For this example, we will leave the setting as **Read / Write**.



DISCOVERY:
READ / WRITE

Setting the IR Channel for the Matrix Controller

1. From the *standby screen*, press the **Menu** button. See [Accessing the Menu System \(page 75\)](#) for information on how to display the *standby screen*.
2. The **Network** menu will be displayed.

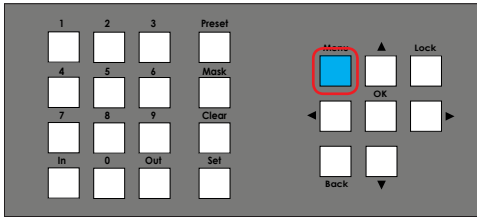

OR

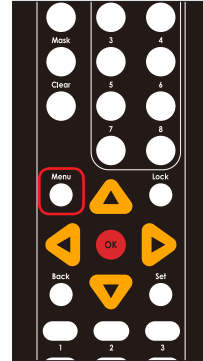

3. Press the ▲ or ▼ buttons to select the **System** menu.

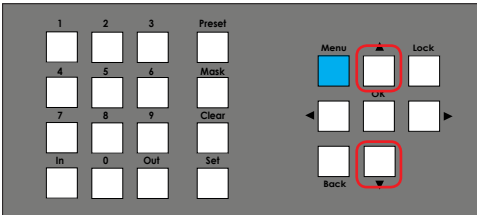

OR

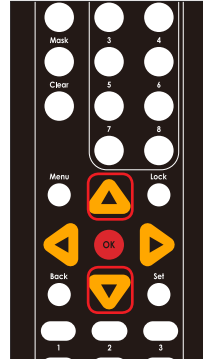

4. Press the **OK** button to enter the **System** menu. The IR Channel setting will be displayed.

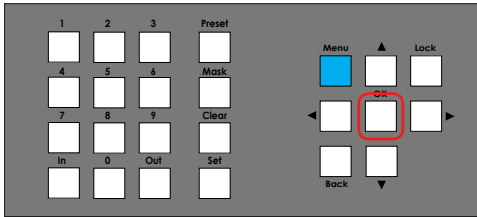

OR

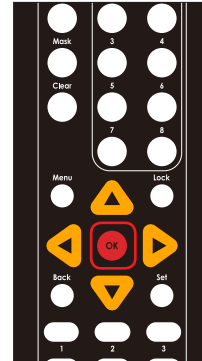

5. Press the **OK** button to edit the current value.



6. Press the **▲** or **▼** buttons to select the desired IR channel (1 - 4).



7. Press the **OK** button to save the current changes.



Front Panel Lockout

By default, the front panel lockout is enabled and will automatically lock after five minutes. To enable or disable the front-panel lockout, follow the instructions below. To set the timeout value (in minutes), see [Front Panel Timeout \(page 131\)](#).

1. From the *standby screen*, press the **Menu** button. See [Accessing the Menu System \(page 75\)](#) for information on how to display the *standby screen*.
2. The **Network** menu will be displayed.

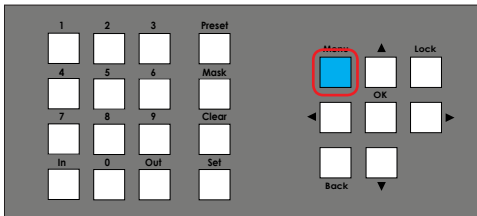

OR

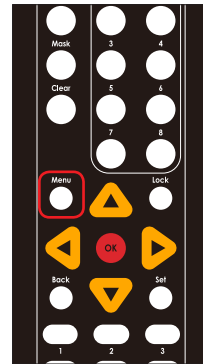

3. Press the ▲ or ▼ buttons to select the **System** menu.

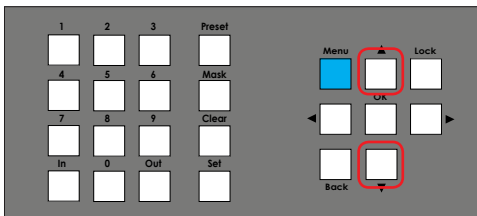

OR

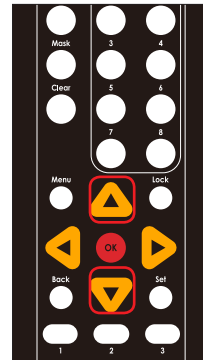

4. Press the **OK** button to enter the **System** menu. The IR Channel setting will be displayed.

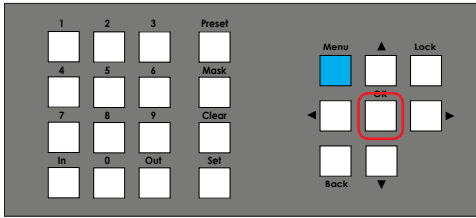

OR

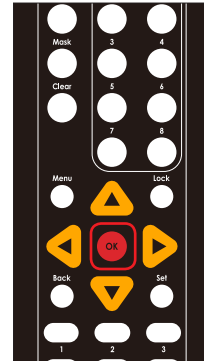

5. Press the **▲** or **▼** buttons to select the **Auto-Lock Timeout** menu.

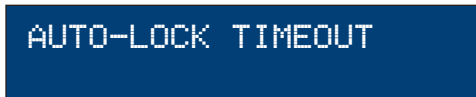

6. Press the **OK** button to enter the **Auto-Lock Timeout** menu. The current setting will be displayed. The default setting is *enabled*.



7. Press the **▲** or **▼** buttons to enable or disable the **Auto-Lock** feature. For this example, we will leave the setting on *enabled*.
8. Press the **OK** button to save the changes. The saved setting will be displayed.



Front Panel Timeout

By default, the front panel will automatically lock after five minutes. This timeout value can be adjusted between one and ten minutes.

1. From the *standby screen*, press the **Menu** button. See [Accessing the Menu System \(page 75\)](#) for information on how to display the *standby screen*.
2. The **Network** menu will be displayed.

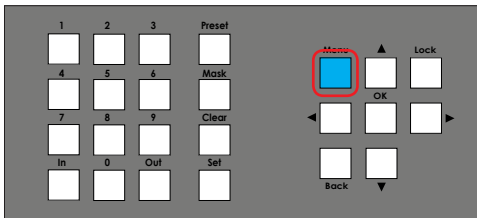

OR

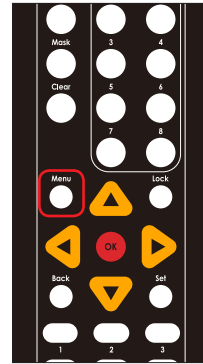

3. Press the ▲ or ▼ buttons to select the **System** menu.

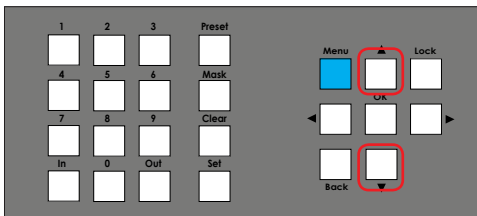

OR

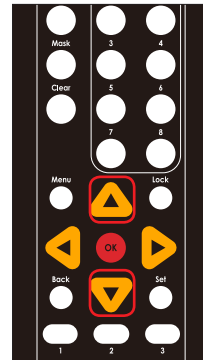

- Press the **OK** button to enter the **System** menu. The IR Channel setting will be displayed.

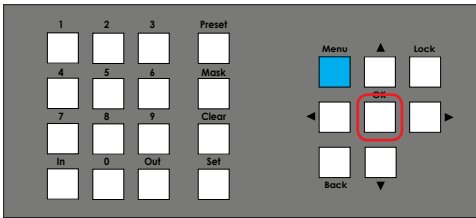

OR

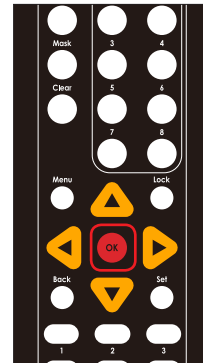

- Press the **▲** or **▼** buttons to select the **Time-Out In Min.** menu.

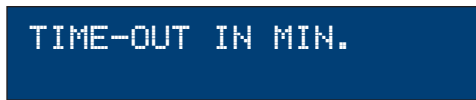

- Press the **OK** button to enter the **Time-Out In Min.** menu. The current timeout value will be displayed. The default value is five minutes.

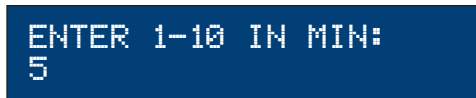

- Press the **▲** or **▼** buttons to set the timeout value between one and ten minutes.

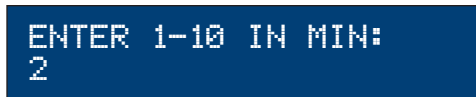

- Press the **OK** button to save the changes.



Resetting the Matrix Controller

Resetting the Matrix Controller will erase all current configurations and return the Matrix Controller to factory-default settings. If you need to reset the Matrix without erasing any current settings, refer to [Rebooting the Matrix Controller \(page 137\)](#).



Warning

The following procedure will *reset* the Matrix Controller to factory-default settings. All IP settings and network configurations will be lost!

1. Before resetting the Matrix Controller, you may want to save the current settings to a configuration file. If you do not want to save the configuration settings, then skip to Step 2.
 - a. Login to the Web interface.
 - b. Click the **System** tab.
 - c. Click the **Download** button.

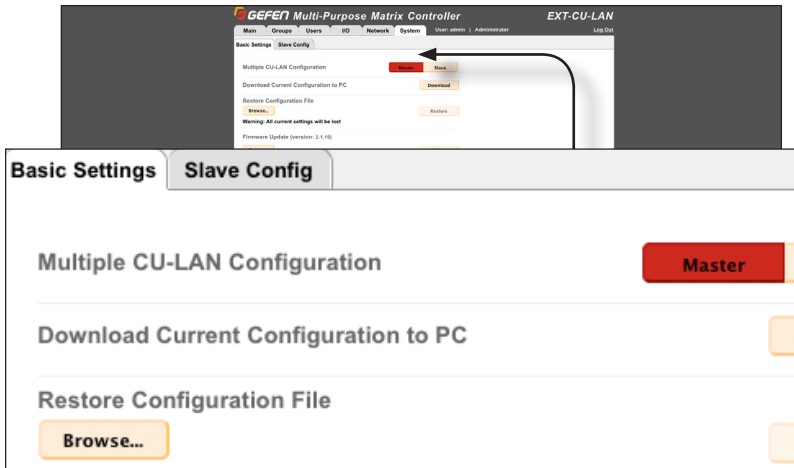

- d. Select a destination folder where the configuration file will be saved.

The filename will include a date stamp, based on the date set on the computer. For example, if the date was August 24, 2015, then the filename would be:

CU-LAN_Settings_08-24-2015-11-28.xml.

- From the *standby screen*, press the **Menu** button. See [Accessing the Menu System \(page 75\)](#) for information on how to display the *standby screen*.
- The **Network** menu will be displayed.

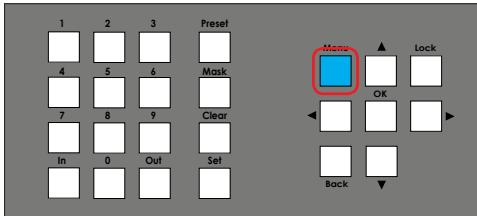

OR

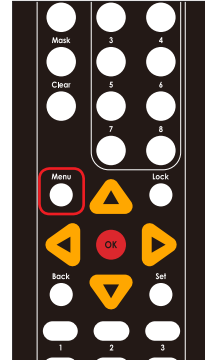

- Press the ▲ or ▼ buttons to select the **System** menu.

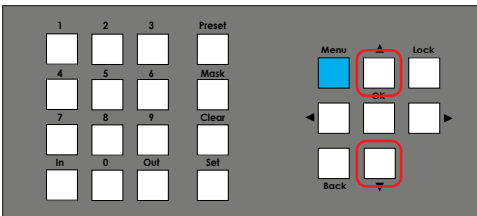

OR

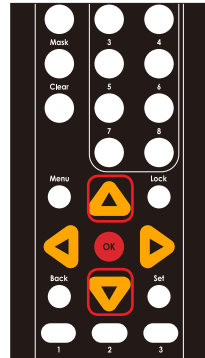

5. Press the **OK** button to enter the menu. The current **IR Channel** will be displayed.

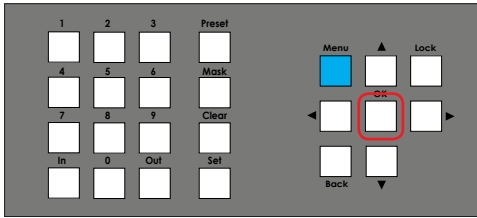

OR

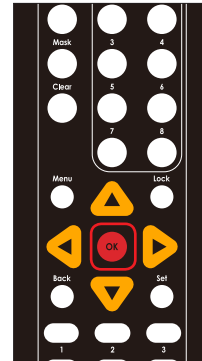

6. Press the **▲** or **▼** buttons to select the **Factory Reset** option.



7. Press the **OK** button to continue.
8. The Matrix Controller will prompt you to confirm that you wish to proceed:



9. Press the **▲** or **▼** buttons to select between **Yes** and **No** options.
- ▶ To reset the Matrix Controller to factory-default settings, select **Yes** and press the **OK** button.
 - ▶ To cancel the procedure, select **No** and press the **OK** button.

10. If the Matrix Controller is reset, the following message will be displayed:



```
FACTORY DEFAULT  
RESTORED...REBOOTING
```

11. After about 30 seconds, the *passcode screen* will be displayed.



```
ENTER PASSCODE:
```

Rebooting the Matrix Controller

Rebooting the Matrix Controller is identical to disconnecting and reconnecting the power supply on the back of the unit. Rebooting the Matrix Controller may be required after changing specific system settings. Rebooting does not reset the Matrix Controller to factory-default settings. To reset the Matrix Controller, see [Resetting the Matrix Controller](#) (page 133).

1. From the *standby screen*, press the **Menu** button. See [Accessing the Menu System](#) (page 75) for information on how to display the *standby screen*.
2. The **Network** menu will be displayed.

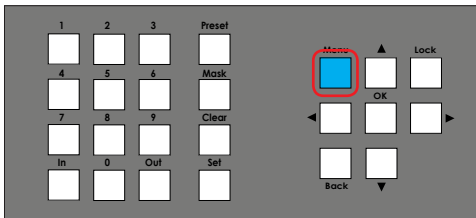

OR

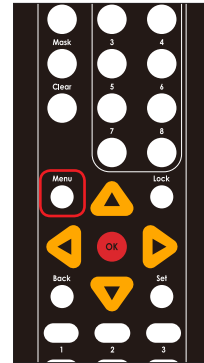

3. Press the ▲ or ▼ buttons to select the **System** menu.

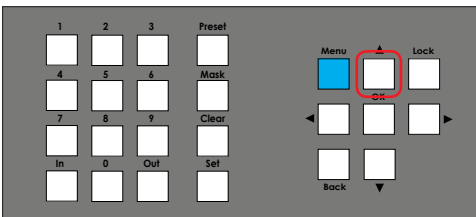

OR

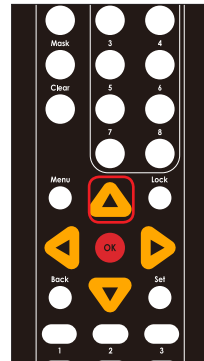

4. Press the **OK** button to enter the menu.
5. The current **IR Channel** will be displayed.

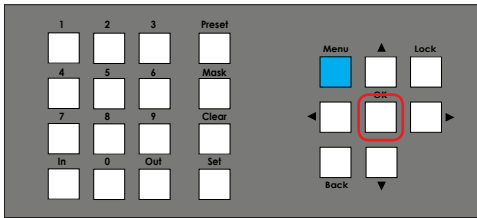

OR

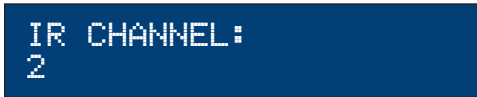
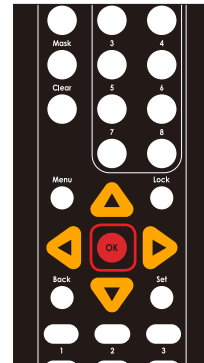

6. Press the **▲** or **▼** buttons to select the **Reboot Unit** option.



7. Press the **OK** button to continue. The Matrix Controller will prompt you to confirm that you wish to proceed:



8. Press the **▲** or **▼** buttons to select between **Yes** and **No** options.
 - ▶ To reboot the Matrix Controller, select **Yes** and press the **OK** button.
 - ▶ To cancel the procedure, select **No** and press the **OK** button.

9. If the Matrix Controller is rebooted, the following message will be displayed:



```
REBOOTING...
```

10. After about 30 seconds, the *passcode screen* will be displayed.



```
ENTER PASSCODE:
```

Locking / Unlocking the Matrix Controller

The front panel of the Matrix Controller can be locked to prevent unauthorized tampering or accidental pressing of the front panel buttons.

1. From any screen (except the **Enter Passcode** screen), press the **Lock** button.

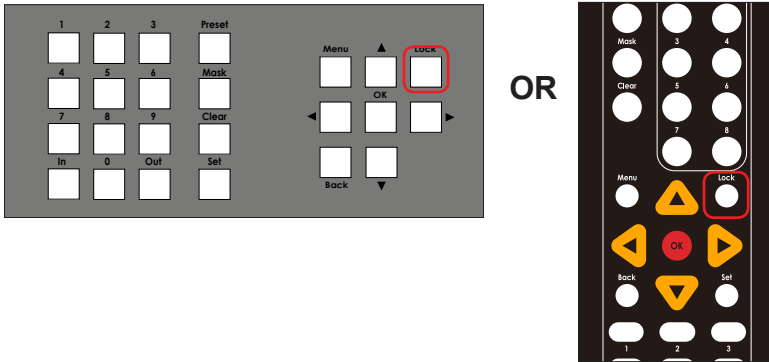

2. The Matrix Controller is now locked and the passcode screen will be displayed.

ENTER PASSCODE:

3. To unlock the Matrix Controller, enter the passcode and press the **OK** button on the front panel or on the IR remote control. The default passcode is 123456.

The built-in Web interface provides advanced control of the Matrix Controller. In order to access the Web interface use the Gefen Syner-G Software Suite to obtain the IP settings of the Matrix Controller. Once connected to the Matrix Controller, the login screen will be displayed.

Login Screen

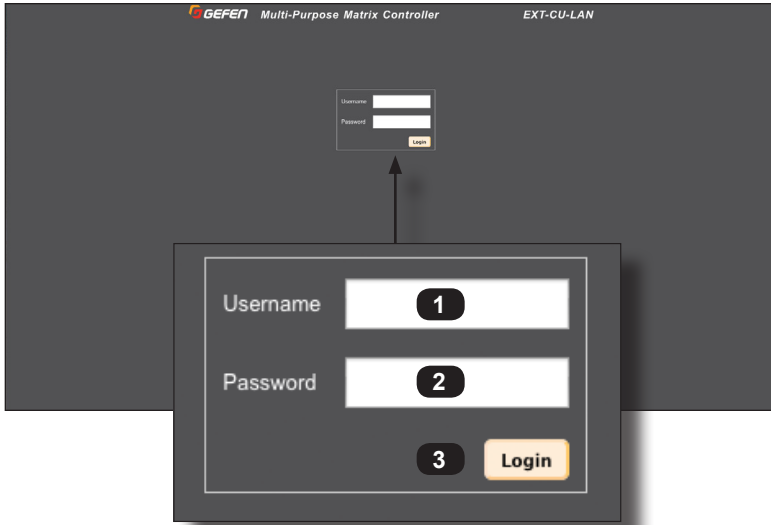

- 1 Username**
Enter the *user* in this field. The Matrix Controller comes with two users: *admin* and *front panel*. The *admin* login provides unrestricted access to all features and settings and is used primarily to create and manage users, groups, presets, and other network settings. The *front panel user* is required in order to control the Matrix Controller through the front panel.
- 2 Password**
Enter the password for the associated *user*. The password is masked when it is entered. If the *front panel user* is used to login, then the password must be the same as the *passcode* used to access the front panel.
- 3 Login**
Click this button to login in to the **Main** page of the Web interface.

Main

The **Main** page is used to manage all *groups* that have been created. If no *groups* have been defined, they will need to be created. See [Creating Groups \(page 38\)](#) for information on creating *groups*.

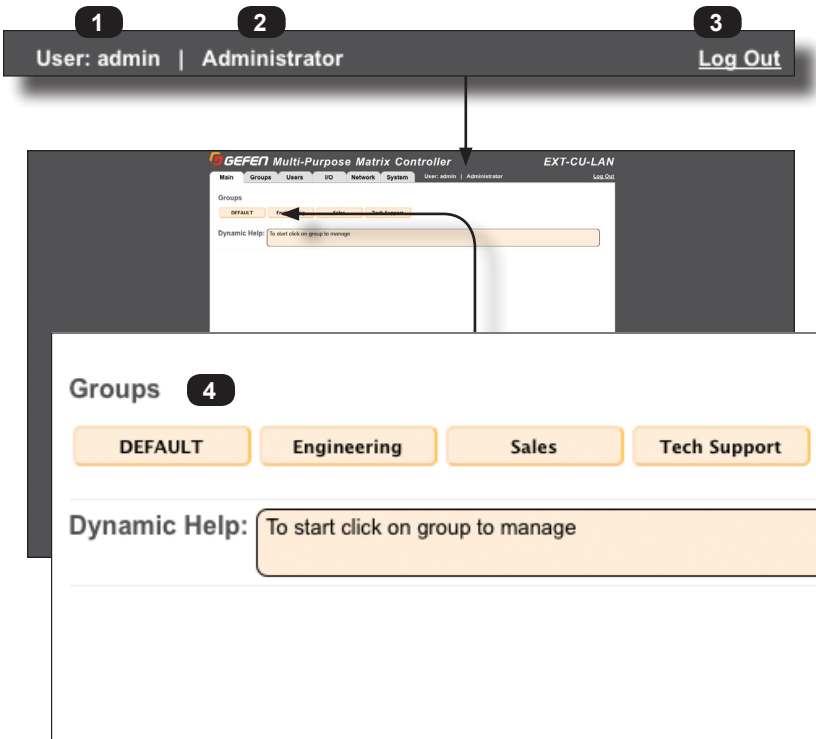

- 1 **User**
The *user* for the current Web session.
- 2 **Access level**
Displays the access level of the *user*. There are three access levels: Operator, Administrator, and Group Administrator. See [Creating Users \(page 30\)](#) for more information on user access levels.
- 3 **Log Out**
Click this link to log out of the current Web session.
- 4 **Group buttons**
Displays a list of all created groups in the form of buttons. Click the desired button to perform routing operations within the *group*.

Clicking a group button displays additional options within the **Main** tab.

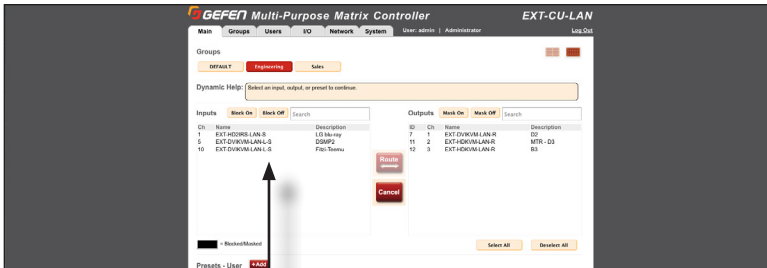

Groups

DEFAULT Engineering Sales

Dynamic Help: Select an input, output, or preset to continue.

1

Inputs Block On Block Off Search 3

4	5	2	6
Ch	Name	Description	
1	EXT-HD2IRS-LAN-S	LG blu-ray	
5	EXT-DVIKVM-LAN-L-S	DSMP2	
10	EXT-DVIKVM-LAN-L-S	File Server	

- 1 Block On**
Click this button to block the source signal at the input. See [Blocking Inputs \(page 54\)](#) for more information.
- 2 Block Off**
Click this button to unblock the selected input. See [Blocking Inputs \(page 54\)](#) for more information.
- 3 Search (Inputs)**
Enter the channel, name, or the description of the unit to search for, under the **Inputs** column.
- 4 Ch (Inputs)**
Displays the channel of the KVM over IP product.
- 5 Name (Inputs)**
The name of the device.
- 6 Description (Inputs)**
Displays the description of the product. By default, the product name is used as a description. This name can be changed using the **Edit Device** button.

The screenshot shows the GEFEN Multi-Purpose Matrix Controller web interface. The main content area displays a table of outputs with columns for ID, Ch, Name, and Description. The table contains the following data:

ID	Ch	Name	Description
7	1	EXT-DVIKVM-LAN-R	D2
11	2	EXT-HDKVM-LAN-R	MTR - D3
12	3	EXT-HDKVM-LAN-R	D3

Numbered callouts (7-15) highlight specific UI elements: 7 (Column View mode button), 8 (Matrix View mode button), 9 (ID column header), 10 (Ch column header), 11 (Name column header), 12 (Mask On button), 13 (Mask Off button), 14 (Description column header), and 15 (Search input field).

7 Column View mode

This is the default view setting for the **Main** tab. Click this button to return to the default view when using *matrix view* mode. See [Matrix View Mode \(page 58\)](#) for more information.

8 Matrix View mode

Click this button to view the Main tab in matrix view mode. See [Matrix View Mode \(page 58\)](#) for more information.

9 ID (Outputs)

The ID of the KVP over IP device. This device is automatically assigned by the Matrix Controller.

10 Ch (Outputs)

Displays the channel of the KVM over IP product.

11 Name (Outputs)

The name of the device.

12 Mask On

Click this button to mask the selected output. See [Masking Outputs \(page 56\)](#) for more information.

13 Mask Off

Click this button to unmask the selected output. See [Masking Outputs \(page 56\)](#)

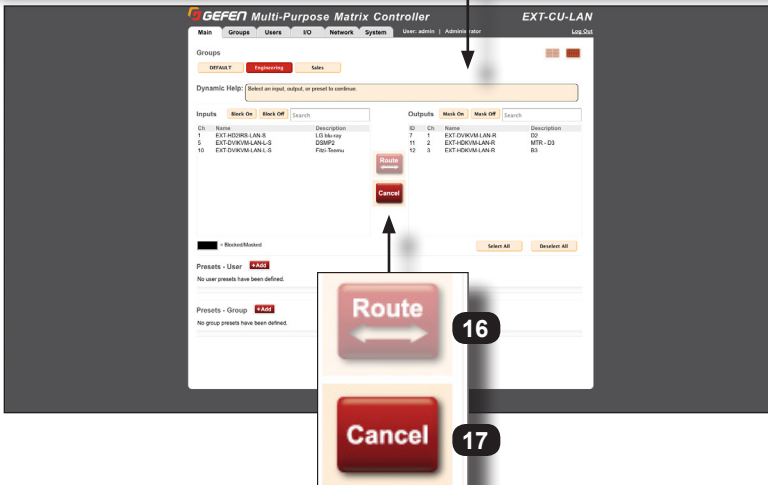
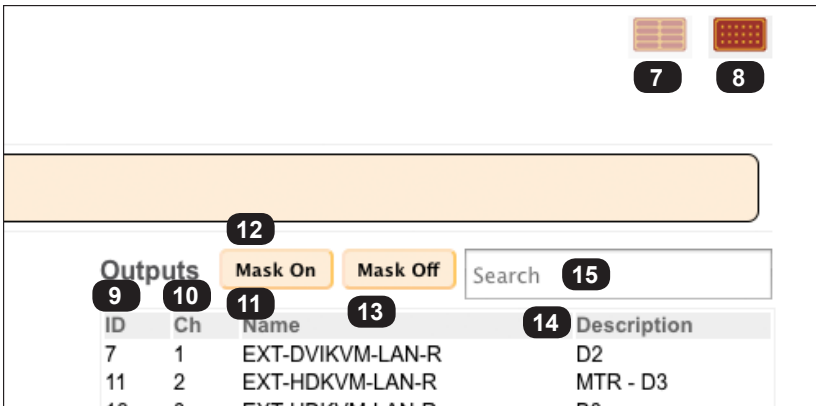

14 Description (Outputs)

Displays the description of the product. By default, the product name is used as a description. This name can be changed using the **Edit Device** button.

15 Search (Outputs)

Enter the ID, channel, name, or description of the unit to search for, under the **Outputs** column.

16 Route

Click this button to route the selected input(s) / output(s).

17 Cancel

Clears the currently selected (highlighted) inputs and outputs.

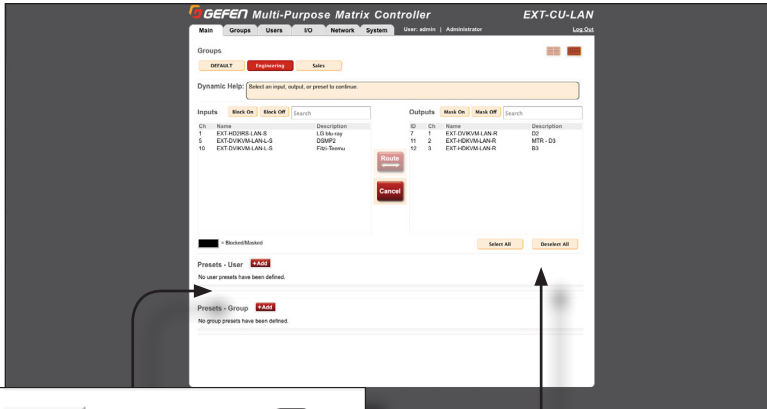

 = Blocked/Masked **18**

Presets - User **+Add** **19**

No user presets have been defined.

20

Presets - Group **+Add**

No group presets have been defined.

21

Select All

22

Deselect All

21 Select All

Click this button to select (highlight) all devices under **Outputs**.

22 Deselect All

Click this button to deselect all devices that are currently selected under **Outputs**.

18 Blocked / Masked (Legend)

If a black rectangle appears under the **Ch** column of the **Inputs** or under the **ID** column of the **Outputs**, then the input / output is blocked / masked. See [Blocking Inputs \(page 54\)](#) and [Masking Outputs \(page 56\)](#) for more information.

19 + Add (Presets - User)

Click this button to add a *user preset* to the *group*. See [Creating User Presets \(page 63\)](#) for more information.

20 + Add (Presets - Group)

Click this button to add a *group preset* to the *group*. See [Creating Group Presets \(page 66\)](#) for more information.

21 Cancel

Clears the currently selected (highlighted) inputs and outputs.

Groups > Inputs / Outputs

This page is used to add inputs and outputs, of available KVM over IP device, to each *group*. If no *groups* have been defined, they will need to be created. If a *group* is created on this page, the *group* will also appear under the **Groups ▶ Members**.

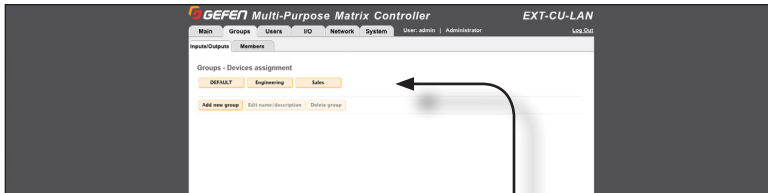

Inputs/Outputs
Members

Groups - Devices assignment

DEFAULT

Engineering

Sales

Add new group

Edit name/description

Delete group

- 1 **Group Name**
Displays each *group* that is created as a button.
- 2 **Add new group**
Click this button to create a new *group*.
- 3 **Edit name / description**
Click this button to change the name and/or description of the selected *group*. This button is enabled only if a *group* button is clicked. This button is not available when the **DEFAULT** group is selected.
- 4 **Delete group**
Click this button to delete the selected *group*. This button is enabled only if a *group* button is clicked. This button is not available when the **DEFAULT** group is selected.

Groups > Members

This page is used to assign *members* to each *group*. If no *groups* have been defined, they will need to be created. If a *group* is created on this page, the *group* will also appear under the **Groups ▶ Inputs / Outputs**. See [Adding Members \(page 47\)](#) for more information.

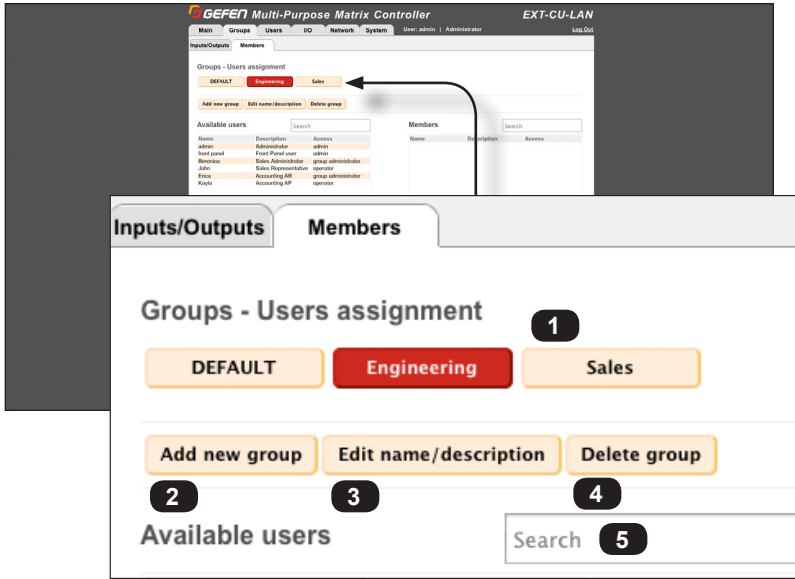

- 1 **Group Name**
Displays each *group* that is created has a button.
- 2 **Add new group**
Click this button to create a new *group*.
- 3 **Edit name / description**
Click this button to change the name and/or description of the selected *group*. This button is enabled only if a *group* button is clicked. This button is not available when the **DEFAULT** group is selected.
- 4 **Delete group**
Click this button to delete the selected *group*. This button is enabled only if a *group* button is clicked. This button is not available when the **DEFAULT** group is selected.
- 5 **Search box**
To quickly search for a user in the Available Users list, enter the user in this text box.

Available users 6

Name	Description	Access
admin	Administrator	admin
front panel	Front Panel user	admin
Berenice	Sales Administrator	group administrator
John	Sales Representative	operator
Erica	Accounting AR	group administrator
Kayla	Accounting AP	operator

Groups - Users assignment

DEFAULT **Members**

Available users

Name	Description	Access
admin	Administrator	admin
front panel	Front Panel user	admin
Berenice	Sales Administrator	group administrator
John	Sales Representative	operator
Erica	Accounting AR	group administrator
Kayla	Accounting AP	operator

Members

Name	Description	Access
------	-------------	--------

7

8

6 Available users

Lists all users that have been created. The admin and front panel user names are indigenous to the Matrix Controller and cannot be deleted. See [Creating Users \(page 30\)](#) for more information. For details on how to add members to groups, see [Adding Members \(page 47\)](#).

7 Right Arrow Icon

Click this button to move the selected users, under the **Available users** list, to the **Members** list. This button is only enabled when one or more *users* have been selected from the **Available users** list. See [Adding Members \(page 47\)](#) for more information.

8 Left Arrow Icon

Click this button to move the selected Members to the Available users list. This button is only enabled when one or more *members* have been selected from the **Member** list. See [Removing Members \(page 49\)](#) for more information.

Members **9** **10**

Name	Description	Access
admin	Administrator	admin
front panel	Front Panel user	admin
Berenice	Sales Administrator	group administrator
John	Sales Representative	operator

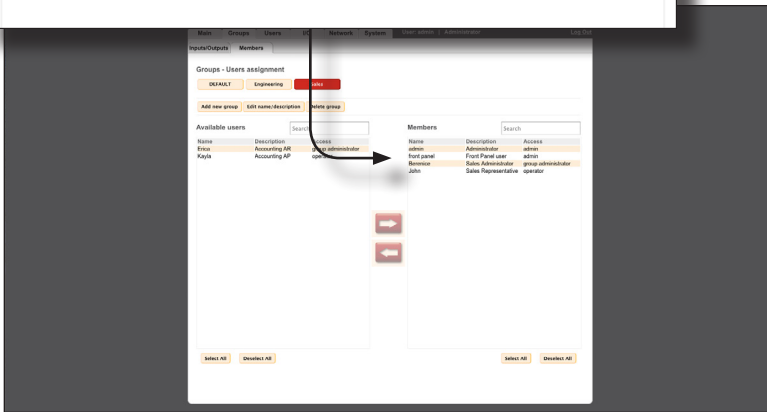

9 Members

Lists all members that have been added to the current *group*. See [Adding Members \(page 47\)](#) for more information.

10 Search box

To quickly search for a *member* under the **Members** list, enter the *member* name in this text box.

Users

The **Users** page is used to add, edit, and delete users. You will be asked to create a *user*, *password*, and specify an *access level* (**Administrator**, **Group Administrator**, or **Operator**) for each *user* that is created. See [Creating Users \(page 30\)](#) for more information on user access levels.

The screenshot shows the GEFEN Multi-Purpose Matrix Controller web interface. The 'Users' page is active, displaying a table of users. A callout box highlights the 'Users' section with numbered markers 1, 2, 3, and 4. The table lists the following users:

Name	Description	Access Level
admin	Administrator	admin
front panel	Front Panel user	admin
Berenice	Sales Administrator	group administrator
John	Sales Representative	operator
Erica	Accounting AR	group administrator
Kayla	Accounting AP	operator

At the bottom of the callout box, there are three buttons: **Add User** (2), **Edit User** (3), and **Delete User** (4).

- 1 Users**
Displays the name, description, and access level for all users.
- 2 Add User**
Click this button to add a *user*.
- 3 Edit User**
Click this button to edit the *user*, description, access level, and password of the selected *user*. This button is enabled when a *user* is selected.
- 4 Delete User**
Click this button to delete the selected *user*. This button is enabled only if a *user* is selected.

I/O

The **I/O** page is used to manage all Gefen KVM over IP products that are connected to the network and detected by the Matrix Controller. The I/O page contains two columns: **Inputs** and **Outputs**.

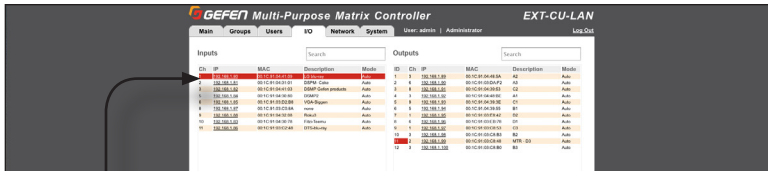

Inputs		Search 1		
2	3	4	5	6
Ch	IP	MAC	Description	Mode
1	192.168.1.80	00:1C:91:04:41:09	LG blu-ray	Auto
2	192.168.1.81	00:1C:91:04:31:01	DSPM- Coke	Auto
3	192.168.1.82	00:1C:91:04:41:03	DSMP Gefen products	Auto
5	192.168.1.84	00:1C:91:04:30:80	DSMP2	Auto
6	192.168.1.85	00:1C:91:03:D2:B8	VGA-Siggen	Auto
8	192.168.1.87	00:1C:91:03:C0:8A	none	Auto
9	192.168.1.88	00:1C:91:04:32:08	Roku3	Auto
10	192.168.1.83	00:1C:91:04:30:78	Fitzi-Teemu	Auto

1 Search (Inputs)

Enter the IP address, MAC address, or the description of the unit to search for under the **Inputs** column.

2 Ch (Inputs)

Displays the channel of the KVM over IP product.

3 IP (Inputs)

Displays the IP address of the KVM over IP product. You can access the Web interface of the KVM over IP (Sender unit) by clicking the desired IP address, under this column.

4 MAC (Inputs)

Displays the MAC address of the product.

5 Description (Inputs)

Displays the description of the product. By default, the product name is used as a description. This name can be changed using the **Edit Device** button.

6 Mode (Inputs)

Displays the network mode of the KVM over IP product. The different modes are: Auto, Static, and DHCP. See the product manual for the KVM over IP for more information about network modes.

The screenshot shows the 'Outputs' section of the GEFEN Multi-Purpose Matrix Controller web interface. A search bar is located at the top right of the table area, with a callout '7' pointing to it. Below the search bar is a table with the following columns: ID, Ch, IP, MAC, Description, and Mode. Callouts 8 through 13 point to these columns respectively. The table contains several rows of data, with the first row being highlighted in orange.

ID	Ch	IP	MAC	Description	Mode
1	3	192.168.1.89	00:1C:91:04:48:5A	A2	Auto
2	6	192.168.1.90	00:1C:91:03:DA:F2	A3	Auto
3	8	192.168.1.91	00:1C:91:04:39:53	C2	Auto
4	3	192.168.1.92	00:1C:91:04:48:BE	A1	Auto
5	9	192.168.1.93	00:1C:91:04:39:3E	C1	Auto
6	5	192.168.1.94	00:1C:91:04:39:55	B1	Auto
7	1	192.168.1.95	00:1C:91:03:E8:42	D2	Auto

7 Search (Outputs)

Enter the IP address, MAC address, or the description of the unit to search for under the **Outputs** column.

8 ID (Outputs)

Displays the ID of the KVM over IP device.

9 Ch (Outputs)

Displays the channel of the KVM over IP product.

10 IP (Outputs)

Displays the IP address of the KVM over IP product. You can access the Web interface of the KVM over IP (Receiver unit) by clicking the desired IP address, under this column.

11 MAC (Outputs)

Displays the MAC address of the product.

12 Description (Outputs)

Displays the description of the product. By default, the product name is used as a description. This name can be changed using the **Edit Device** button.

13 Mode (Outputs)

Displays the network mode of the KVM over IP product. The different modes are: Auto, Static, and DHCP. See the product manual for the KVM over IP for more information about network modes.

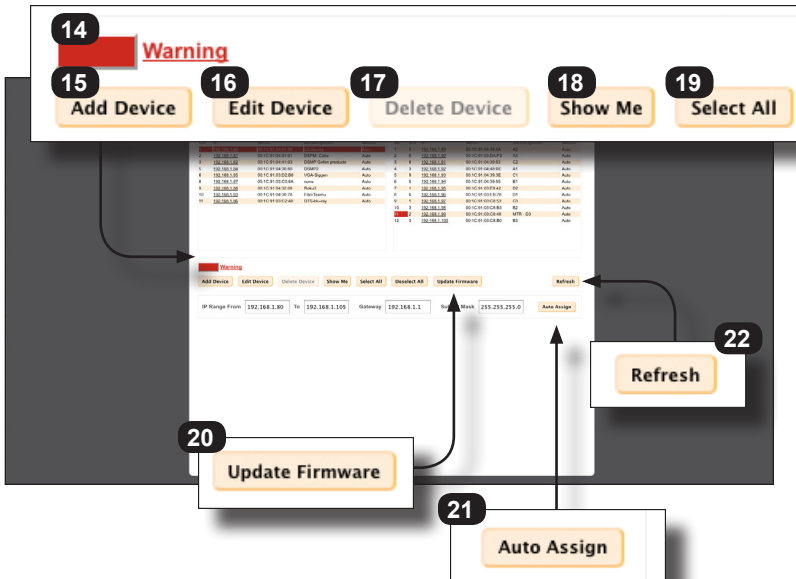

14 Warning

Indicates an error has occurred with a device or setting. Click the **Warning** link to get information about the warning. For example, this warning indicates that the Matrix Controller has detected old firmware on one of the connected devices:

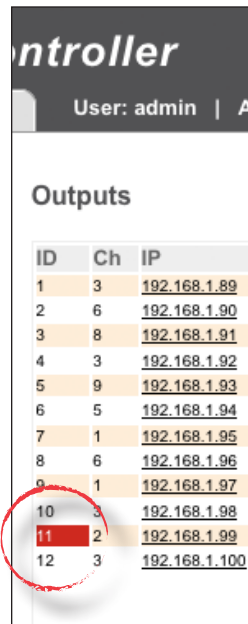
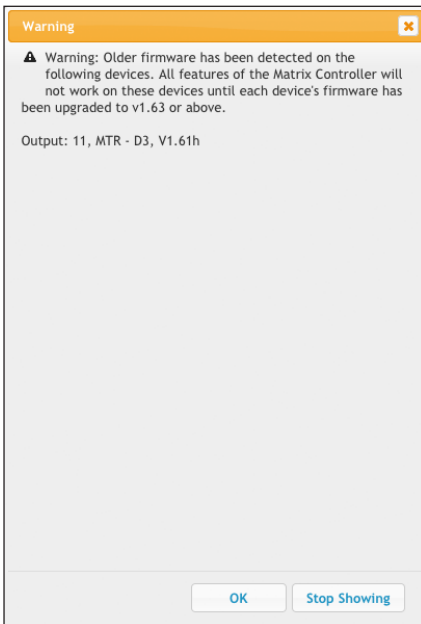

Click the **Stop Showing** button to clear the error or click the OK button to return to the **I/O** tab. To “restore” the error so that it appears, use the **Reset All Warning** button, found under the **System** tab. See [System > Basic Settings \(page 163\)](#) for more information.

15 Add Device

Normally, the Matrix Controller will automatically attempt to connect and retrieve device information. However, if the KVM over IP device has a unique IP address, then click this button to add a device to the list. The IP address and Telnet port of the device must be provided.

16 Edit Device

Click this button to edit settings and description of the selected device.

17 Delete Device

Click this button to remove a device from the list.

18 Show Me

Click this button to activate the “show me” feature on the selected device. This button will “remember” the “show me” state of a device. For example, if a selected device is in “Show Me” mode, then the button will display as “Hide Me”. Conversely, if a selected device is *not* in “Show Me” mode, then the button will be displayed as “Show me”.

19 Select All

Click this button to select all devices under both the Inputs and Outputs column.

20 Update Firmware

Click this button to update the selected units with the latest version of firmware. This button will only be selectable if one or more Inputs or Outputs are selected. See [Updating Sender and Receiver Units \(page 221\)](#) for more information.

21 Auto Assign

Click this button to auto-assign the IP address, ID, and Channel of the selected device(s). This button should only be used if there are conflicting ID numbers (outputs only) or Channel numbers (inputs only).

22 Refresh

Click this button to refresh the page. This button should be used instead of the refresh function of the Web browser.

IP Range From To

The screenshot shows the 'Network' configuration page of the GEFEN Multi-Purpose Matrix Controller. The 'IP Range From' field is highlighted with callout 23, and the 'Gateway' field is highlighted with callout 25. The interface includes a navigation menu at the top with options like Main, Groups, Users, VO, Network, System, User Admin, and Administrator. Below the navigation, there are sections for 'Inputs' and 'Outputs' with search bars and tables. The 'Inputs' table has columns for Ch, IP, MAC, Description, and Mode. The 'Outputs' table has columns for ID, Ch, IP, MAC, Description, and Mode. At the bottom, there are buttons for 'Add Device', 'Edit Device', 'Delete Device', 'Show Me', 'Select All', 'Deinstall All', 'Update Firmware', and 'Refresh'. Below these buttons, there are input fields for 'IP Range From', 'IP Range To', 'Gateway', 'Subnet Mask', and 'Auto Assign'.

Gateway Subnet Mask

- 23 IP Range (From)**
Enter the starting IP address to use. This information is used by the Auto Assign button.
- 24 IP Range (To)**
Enter the starting IP address to use. This information is used by the Auto Assign button.
- 25 Gateway**
Enter the gateway address in this field.
- 26 Subnet Mask**
Enter the subnet mask address in this field.

Network > IP

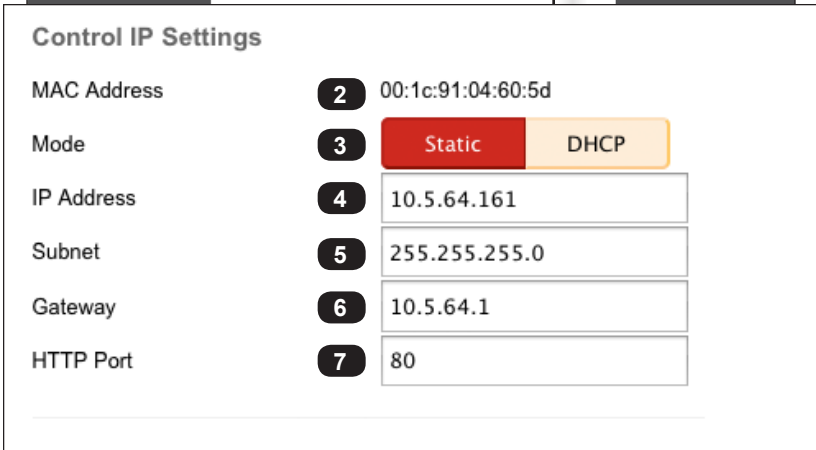
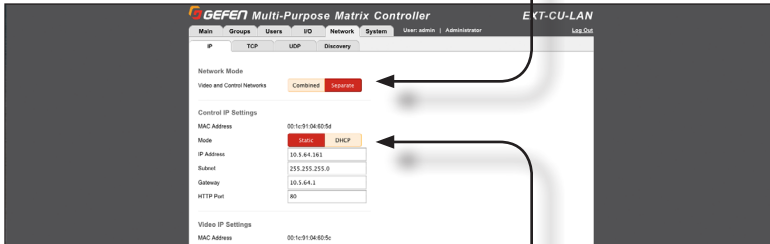

- 1 **Video and Control Networks**
Click to switch between *combined* and *separate* modes. See [Combined Mode](#) (page 9) and [Separate Mode](#) (page 13) for more information.
- 2 **MAC Address**
Displays the MAC address of the Matrix Controller.
- 3 **Mode**
Selects the network mode: Static or DHCP.
- 4 **IP Address**
Enter the IP address of the Matrix Controller. This field is only available if the Mode is set to Static.
- 5 **Subnet**
The subnet mask in this field.
- 6 **Gateway**
The gateway address.
- 7 **HTTP Port**
Enter the HTTP listening port.

- 8 MAC Address**
The MAC address of the managed switch to which the KVM over IP devices are connected.
- 9 Mode**
The network mode of the video network.
- 10 IP Address**
The IP address of the video network.
- 11 Subnet**
The subnet mask of the video network.
- 12 Gateway**
The gateway address of the video network.
- 13 Gateway**
Enables or disables Web access. Enabling this features allows you to access the Matrix Controller Web interface through the video network. Once enabled, connect a computer to the same switch that the KVM over IP products are connected to, then enter the IP address in the Web browser.
- 14 Save**
Click this button so save any changes on this page.

Video IP Settings

MAC Address	8	00:1c:91:04:60:5c
Mode	9	<div style="display: flex; justify-content: space-between; border: 1px solid #ccc; padding: 2px;"> Static DHCP </div>
IP Address	10	<input style="width: 100%;" type="text" value="192.168.1.4"/>
Subnet	11	<input style="width: 100%;" type="text" value="255.255.255.0"/>
Gateway	12	<input style="width: 100%;" type="text" value="192.168.1.1"/>
Web Access	13	<div style="display: flex; justify-content: space-between; border: 1px solid #ccc; padding: 2px;"> Enabled Disable </div>

14 Save

Video IP Settings

MAC Address 00:1c:91:04:60:5c

Mode Static DHCP

IP Address

Subnet

Gateway

Web Access Enabled Disable

Save

Network > TCP

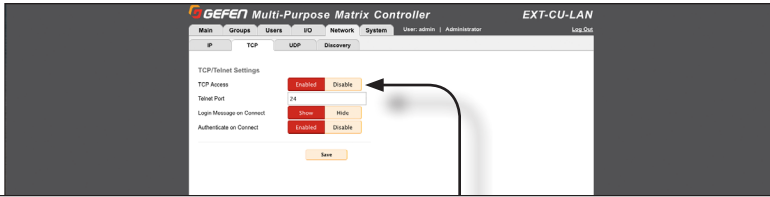

TCP/Telnet Settings

TCP Access

1

Enabled

Disable

Telnet Port

2

24

Login Message on Connect

3

Show

Hide

Authenticate on Connect

4

Enabled

Disable

5

Save

- 1 **TCP Access**
Click these buttons to enable or disable TCP access.
- 2 **Telnet Port**
Enter the Telnet listening port in this field.
- 3 **Login Message on Connect**
Click these buttons to show or hide the Telnet welcome message at the beginning of each Telnet session.
- 4 **Authenticate on Connect**
Click these buttons to enable or disable login credentials for TCP access.
- 5 **Save**
Click this button to save all changes on this page.

Network > UDP

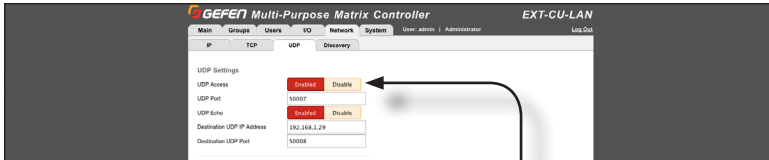

UDP Settings

UDP Access

1

Enabled

Disable

UDP Port

2

50007

UDP Echo

3

Enabled

Disable

Destination UDP IP Address

4

192.168.1.29

Destination UDP Port

5

50008

6

Save

- 1 **UDP Access**
Click these buttons to enable or disable UDP access.
- 2 **UDP Port**
Enter the local UDP listening port in this field.
- 3 **UDP Echo**
Click these buttons to enable or disable UDP echo.
- 4 **Destination UDP IP Address**
Enter the remote UDP IP address in this field.
- 5 **Destination UDP Port**
Enter the remote UDP listening port in this field.
- 6 **Save**
Click this button to save all changes on this page.

Network > Discovery

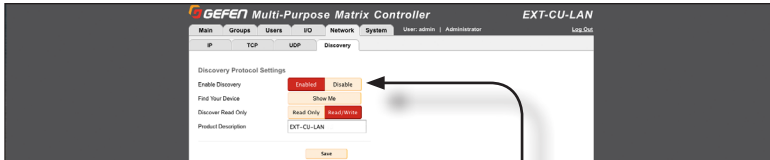

Discovery Protocol Settings

Enable Discovery

1

Enabled

Disable

Find Your Device

2

Show Me

Discover Read Only

3

Read Only

Read/Write

Product Description

4

EXT-CU-LAN

5

Save

1 Enable Discovery

Click these buttons to enable or disable the Discovery feature. In order for the Matrix Controller to be discovered on a network using Gefen Syner-G, this feature must be enabled.

2 Find Your Device

Click this button to show the location of the device. When the **Show Me** button is clicked, the button text will change to **Hide Me** and the following buttons, highlighted in blue, will flash on the front panel of the Matrix Controller:

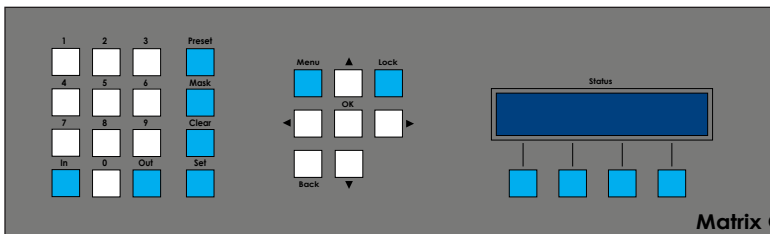

Click the **Hide Me** button to stop the buttons from flashing.

Discovery Protocol Settings

Enable Discovery	1	Enabled	Disable
Find Your Device	2	Show Me	
Discover Read Only	3	Read Only	Read/Write
Product Description	4	EXT-CU-LAN	

5 Save

3 Discover Read Only

Click the **Read Only** button to restrict anyone using the Syner-G Software Suite from changing the settings of the Matrix Controller. Click the **Read / Write** button to allow anyone to read or change the settings of the Matrix Controller.

4 Product Description

Enter the name of the Matrix Controller in this field. The default name is EXT-CU-LAN.

5 Save

Click this button to save all changes on this page.

System > Basic Settings



Basic Settings
Slave Config

Multiple CU-LAN Configuration 1 Master Slave

Download Current Configuration to PC 2 Download

Restore Configuration File

Browse... 3 4 Restore

Warning: All current settings will be lost

Firmware Update (version: 2.2.9)

Browse... 5 6 Update

Factory Reset 7 Reset

Reboot 8 Reboot

Set Auto-Lock Timeout 5 minute(s) 9 Submit

Reset All Warnings 10 Reset

- 1 **Multiple CU-LAN Configuration**
Click this button to switch between Master and Slave mode. See [Configuring Slave Units \(page 16\)](#) for more information on using this feature.
- 2 **Download**
Click this button to download the current Matrix Controller configuration to a file. The filename will include a date stamp, based on the date set on the computer. For example, if the date was August 24, 2015, then the filename would be: CU-LAN_Settings_08-24-2015-11-28.xml.
- 3 **Browse... (Restore Configuration File)**
Click to select the configuration file to upload.

- 4 Restore**
Click this button to restore the selected configuration file. This button is only available once the configuration file is selected, using the **Browse...** button, under **Restore Configuration File**.
- 5 Browse... (Firmware Update)**
Click this button to select the firmware file.
- 6 Update**
Click the Update button to begin the firmware update procedure. This button is only available once a firmware file is selected using the **Browse...** button, under **Firmware Update**.
- 7 Reset**
Click the **Reset** button to reset the Matrix Controller to factory-default settings.
- 8 Reboot**
Click the **Reboot** button to reboot the Matrix Controller.
- 9 Set Auto-Lock Timeout**
Sets the time interval when the front panel will automatically be locked. Click the drop-down list to select the desired timeout period. The timeout can be set from **1** to **10** minutes (in intervals of 1 minute) or to **Never**.
- 10 Submit**
Click this button to save the change to the **Set Auto-Lock Timeout** setting.
- 11 Reset All Warnings**
Click this button to restore the selected configuration file.

System > Slave Config

The screenshot shows the 'Slave Config' tab in the GEFEN Multi-Purpose Matrix Controller web interface. The 'Connected Slaves' section contains a table with the following data:

IP	MAC	Description
10.5.64.18	00:1C:91:04:60:63	EXT-CU-LAN

Buttons 'Delete Device' (1) and 'Show Me' (2) are located above the table. Buttons '3' and '4' are located below the table.

1 Delete Device

Click this button to delete the selected slave Matrix Controller from the list.

2 Show Me

Click this button to show the physical location of the device. When the **Show Me** button is clicked, the button text will change to **Hide Me** and the following buttons, highlighted in blue, will flash on the front panel of the Matrix Controller:

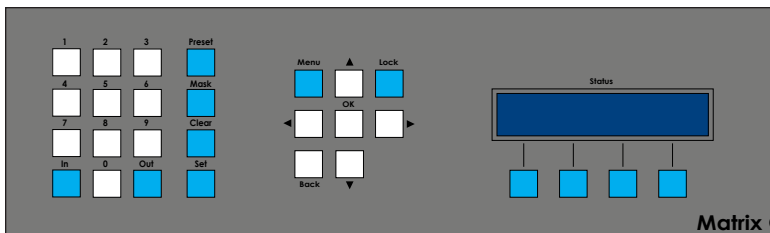

Click the **Hide Me** button to stop the buttons from flashing.

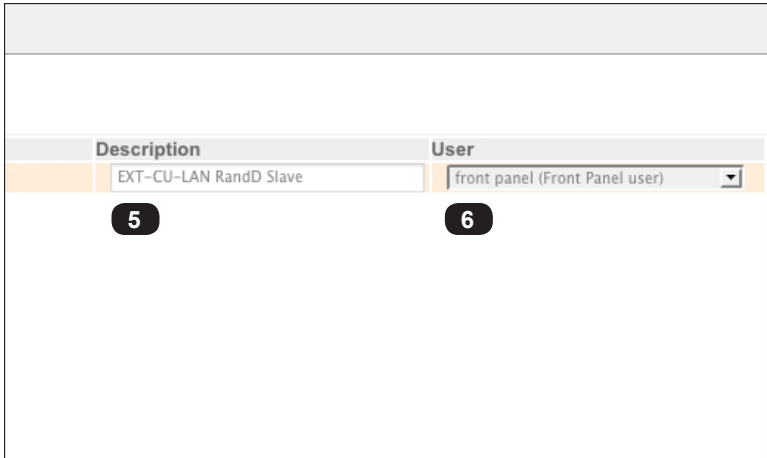

Description	User
EXT-CU-LAN RandD Slave	front panel (Front Panel user)

- 3 IP**
Displays the IP address of each slave Matrix Controller.
- 4 MAC**
Displays the MAC address of each slave Matrix Controller.
- 5 Description**
Displays the description of each slave Matrix Controller.
- 6 User**
Click this drop-down list to select the user.

This page left intentionally blank.

This page left intentionally blank.

Matrix Controller

3

Advanced Operation

Command	Description
#factory_reset	Resets the Matrix Controller to factory-default settings
#get_block	Returns the “block” status of the specified input
#get_discovery	Returns the Discovery Service status
#get_discovery_mode	Returns the mode of the Discovery Service
#get_firmware_version	Returns the current version of firmware
#get_gateway	Returns the gateway address
#get_ip_address	Returns the IP address
#get_ip_mode	Returns the IP mode
#get_ipconfig	Returns the current IP settings
#get_mask	Returns the mask status of the specified output
#get_netmask	Returns the subnet mask
#get_telnet_access	Returns the Telnet access status
#get_telnet_pass	Returns the Telnet password status
#get_telnet_port	Returns the Telnet listening port
#get_udp_access	Returns the UDP access status
#get_udp_echo_access	Returns the UDP server echo status
#get_udp_echo_ip	Returns the address of the UDP echo server
#get_udp_echo_port	Returns the listening port of the UDP echo server
#get_udp_port	Returns the UDP listening port
#get_web_port	Returns the HTTP listening port
#help	Returns the list of available commands
#reboot	Reboots the Matrix Controller
#set_block	Blocks the A/V signal on the specified input
#set_discovery	Enables or disables the Discovery Service
#set_discovery_mode	Sets the Discovery Service mode
#set_gateway	Sets the gateway address
#set_ip_address	Sets the IP address of the Matrix Controller
#set_ip_mode	Sets the IP mode
#set_mask	Blocks the A/V signal on the specified output
#set_netmask	Sets the net mask
#set_port_mode	Sets the network port mode
#set_showme	Enables or disables the “Show Me” feature
#set_telnet_access	Enables or disables Telnet access
#set_telnet_port	Sets the Telnet listening port
#set_udp_access	Enables or disables UDP access

Command	Description
#set_udp_echo_access	Enables or disables the UDP echo status
#set_udp_echo_ip	Sets the address of the UDP echo server
#set_udp_echo_port	Sets the listening port of the UDP echo server
#set_udp_port	Sets the UDP listening port
#set_web_port	Sets the HTTP listening port
#use_telnet_login	Enables or disables Telnet login credentials
#use_telnet_welcome	Enables or disables the Telnet welcome message
p	Recalls the specified preset number
r	Routes an input to the specified output(s)

#factory_reset

Reset the Matrix Controller to factory-default settings. The Matrix Controller *must* be power-cycled after executing this command.



Important

This command resets the IP address. If the IP address changes, then the Matrix Controller will be disconnected from the network. Use the Gefen Syner-G Discovery Tool to locate the Matrix Controller and assign the new network settings to work on your network.

Syntax

```
#factory_reset
```

Parameters

None

Example

```
#factory_reset
```

#get_block

Returns the block status of the specified input. If the input is blocked, then `BLOCK ENABLED` is returned.

Syntax

```
#get_block param1
```

Parameters

param1	Integer	[input range]
--------	---------	---------------

Example

```
#get_block 1  
BLOCK DISABLED
```

Related Commands

```
#get_mask  
#set_block  
#set_mask
```

#get_discovery

Returns the Discovery Service status. The value returned is one of the following:

Value	Description
0	Discovery disabled
1	Discovery enabled

Syntax

```
#get_discovery
```

Parameters

None

Example

```
#get_discovery  
DISCOVERY 1
```

Related Commands

```
#get_discovery_mode  
#set_discovery  
#set_discovery_mode  
#set_showme
```

#get_discovery_mode

Returns the Discovery Service mode. The value returned is one of the following:

Value	Description
0	Read mode
1	Read / write mode

Syntax

```
#get_discovery_mode
```

Parameters

None

Example

```
#get_discovery_mode  
DISCOVERY MODE 1
```

Related Commands

```
#get_discovery  
#set_discovery  
#set_discovery_mode  
#set_showme
```

#get_firmware_version

Returns the current version of firmware.

Syntax

```
#get_firmware_version
```

Parameters

None

Example

```
#get_firmware_version  
FIRMWARE VERSION IS 2.1.19
```

#get_gateway

Returns the gateway address of the specified port on the Matrix Controller.

Syntax

```
#get_gateway port
```

Parameters

port

Type: **INTEGER**

Accepts a number from the table below, specifying the port to query.

port	Description
1	Control Port (LAN 1)
2	Video Port (LAN 2)

Example

```
#get_gateway 1  
GATEWAY 1 10.5.64.203
```

Related Commands

```
#get_ip_address  
#get_ip_mode  
#get_ipconfig  
#get_netmask  
#get_web_port  
#set_gateway  
#set_ip_address  
#set_ip_mode  
#set_netmask  
#set_port_mode  
#set_web_port
```

#get_ip_address

Returns the IP address of the specified port on the Matrix Controller.

Syntax

```
#get_ip_address port
```

Parameters

port

Type: **INTEGER**

Accepts a number from the table below, specifying the desired port:

port	Description
1	Control Port (LAN 1)
2	Video Port (LAN 2)

Example

```
#get_ip_address 2  
IP ADDRESS 2 192.168.1.75
```

Related Commands

```
#get_gateway  
#get_ip_mode  
#get_ipconfig  
#get_netmask  
#get_web_port  
#set_gateway  
#set_ip_address  
#set_ip_mode  
#set_netmask  
#set_port_mode  
#set_web_port
```

#get_ip_mode

Returns the current IP mode of the specified port on the Matrix Controller.

Syntax

```
#get_ip_mode port
```

Parameters

port

Type: **INTEGER**

Accepts a number from the table below, specifying the desired port:

port	Description
1	Control Port (LAN 1)
2	Video Port (LAN 2)

Example

```
#get_ip_mode 1  
IP_MODE 1 DHCP
```

Related Commands

```
#get_gateway  
#get_ip_address  
#get_ipconfig  
#get_netmask  
#get_web_port  
#set_gateway  
#set_ip_address  
#set_ip_mode  
#set_netmask  
#set_port_mode  
#set_web_port
```

#get_ipconfig

Returns the current IP settings.

Syntax

```
#get_ipconfig
```

Parameters

None

Example

```
#get_ipconfig
IP CONFIGURATION IS:
IP MODE: DHCP
IP: 10.5.64.203
NETMASK: 255.255.255.0
GATEWAY: 10.5.64.1
MAC ADDRESS: 00:1c:91:04:93:28
```

Related Commands

```
#get_gateway
#get_ip_address
#get_ip_mode
#get_netmask
#get_web_port
#set_gateway
#set_ip_address
#set_ip_mode
#set_netmask
#set_port_mode
#set_web_port
```

#get_mask

Returns the “mask” status of the specified output.

Syntax

```
#get_mask output
```

Parameters

output

Type: **INTEGER**

The channel number of the output port to query.

Example

```
#get_mask 4  
MASK_ENABLED
```

Related Commands

```
#get_block  
#set_block  
#set_mask
```

#get_netmask

Returns the subnet mask of the specified port on the Matrix Controller.

Syntax

```
#get_netmask port
```

Parameters

port

Type: **INTEGER**

Accepts a number from the table below, specifying the desired port:

port	Description
1	Control Port (LAN 1)
2	Video Port (LAN 2)

Example

```
#get_netmask 2  
NETMASK 2 255.255.0.0
```

Related Commands

```
#get_gateway  
#get_ip_address  
#get_ip_mode  
#get_ipconfig  
#get_web_port  
#set_gateway  
#set_ip_address  
#set_ip_mode  
#set_netmask  
#set_port_mode  
#set_web_port
```

#get_telnet_access

Returns the current Telnet access status. The value returned is one of the following:

Value	Description
0	Telnet access disabled
1	Telnet access enabled

Syntax

```
#get_telnet_access
```

Parameters

None

Example

```
#get_telnet_access  
TELNET_ACCESS 1
```

Related Commands

```
#get_telnet_pass  
#get_telnet_port  
#set_telnet_access  
#set_telnet_port  
#use_telnet_login  
#use_telnet_welcome
```

#get_telnet_pass

Returns the Telnet password status. The value returned is one of the following:

Value	Description
0	Telnet password not required
1	Telnet password required

Syntax

```
#get_telnet_pass
```

Parameters

None

Example

```
#get_telnet_pass  
TELNET_PASS 0
```

Related Commands

```
#get_telnet_access  
#get_telnet_port  
#set_telnet_access  
#set_telnet_port  
#use_telnet_login  
#use_telnet_welcome
```

#get_telnet_port

Returns the Telnet listening port.

Syntax

```
#get_telnet_port
```

Parameters

None

Example

```
#get_telnet_port  
TELNET_PORT 23
```

Related Commands

```
#get_telnet_access  
#get_telnet_pass  
#set_telnet_access  
#set_telnet_port  
#use_telnet_login  
#use_telnet_welcome
```

#get_udp_access

Returns the UDP access status. The value returned is one of the following:

Value	Description
0	UDP access disabled
1	UDP access enabled

Syntax

```
#get_udp_access
```

Parameters

None

Example

```
#get_udp_access  
UDP_ACCESS 1
```

Related Commands

```
#get_udp_echo_access  
#get_udp_echo_ip  
#get_udp_echo_port  
#get_udp_port  
#set_udp_access  
#set_udp_echo_access  
#set_udp_echo_ip  
#set_udp_echo_port  
#set_udp_port
```

#get_udp_echo_access

Returns the UDP echo access status. When enabled, the UDP server returns an identical copy of the data that was received.

Syntax

```
#get_udp_echo_access
```

Parameters

None

Example

```
#get_udp_echo_access  
UDP_ECHO_ACCESS 1
```

Related Commands

```
#get_udp_access  
#get_udp_echo_ip  
#get_udp_echo_port  
#get_udp_port  
#set_udp_access  
#set_udp_echo_access  
#set_udp_echo_ip  
#set_udp_echo_port  
#set_udp_port
```

#get_udp_echo_ip

Returns the IP address of the UDP server supporting the echo protocol.

Syntax

```
#get_udp_echo_ip
```

Parameters

None

Example

```
#get_udp_echo_ip  
UDP_ECHO_IP 10.5.64.158
```

Related Commands

```
#get_udp_access  
#get_udp_echo_access  
#get_udp_echo_port  
#get_udp_port  
#set_udp_access  
#set_udp_echo_access  
#set_udp_echo_ip  
#set_udp_echo_port  
#set_udp_port
```

#get_udp_echo_port

Returns the listening port of the UDP server supporting the echo protocol.

Syntax

```
#get_udp_echo_port
```

Parameters

None

Example

```
#get_udp_echo_port  
UDP_ECHO_PORT 50009
```

Related Commands

```
#get_udp_access  
#get_udp_echo_access  
#get_udp_echo_ip  
#get_udp_port  
#set_udp_access  
#set_udp_echo_access  
#set_udp_echo_ip  
#set_udp_echo_port  
#set_udp_port
```

#get_udp_port

Returns the UDP listening port.

Syntax

```
#get_udp_port
```

Parameters

None

Example

```
#get_udp_port  
UDP_PORT 50008
```

Related Commands

```
#get_udp_access  
#get_udp_echo_access  
#get_udp_echo_ip  
#get_udp_echo_port  
#set_udp_access  
#set_udp_echo_access  
#set_udp_echo_ip  
#set_udp_echo_port  
#set_udp_port
```

#get_web_port

Returns the current HTTP listening port.

Syntax

```
#get_web_port
```

Parameters

None

Example

```
#get_web_port  
WEB_PORT 80
```

Related Commands

```
#get_gateway  
#get_ip_address  
#get_ip_mode  
#get_ipconfig  
#get_netmask  
#set_gateway  
#set_ip_address  
#set_ip_mode  
#set_netmask  
#set_port_mode  
#set_web_port
```

#help

Returns the list of available commands. If a command is specified as *param1*, then the description of the command is displayed.

Syntax

```
#help [comm]
```

Parameters

com

Type: **STRING**

This parameter is optional. To request help for a command, type the command name after the #help command. See the example below.

Examples

```
#help  
AVAILABLE TCP/UDP COMMANDS:
```

```
#HELP  
#GET_IPCONFIG  
#SET_PORT_MODE  
#GET_IP_MODE  
#SET_IP_ADDRESS  
...  
...  
#GET_FIRMWARE_VERSION  
#FACTORY_RESET  
#REBOOT
```

```
#help #get_ip_mode  
GET THE CURRENT IP MODE FOR EITHER NETWORK PORT(0 = STATIC, 1 =  
DHCP)  
#GET_IP_MODE PARAM1  
PARAM1 = 1-2 (1 = PORT 1 - CONTROL PORT; 2 = PORT 2 - VIDEO PORT)
```

#reboot

Reboots the Matrix Controller.

Syntax

```
#reboot
```

Parameters

None

Example

```
#reboot  
UNIT WILL REBOOT SHORTLY
```

#set_block

Blocks or unblocks the channel number of the specified input. Blocked inputs will not send A/V signals to the outputs to which they are routed.

Syntax

```
#set_block ch state
```

Parameters

ch

Type: **INTEGER**

The channel number of the input to block or unblock.

state

Type: **INTEGER**

Accepts a number from the table below, specifying whether or not to block the input.

state	Description
0	Unblock
1	Block

Example

```
#set_block 1
BLOCK ENABLED
```

Related Commands

```
#get_block
#get_mask
#set_mask
```

#set_discovery

Enables or disables the Discovery Service. This service is used by the Gefen Syner-G Discovery Tool. The default value is Enabled.

Syntax

```
#set_discovery state
```

Parameters

state

Type: **INTEGER**

Accepts a number from the table below, specifying whether or not to enable the Discovery Service.

state	Description
0	Disabled
1	Enabled

Example

```
#set_discovery 1  
DISCOVERY 1
```

Related Commands

```
#get_discovery  
#get_discovery_mode  
#set_discovery_mode
```

#set_discovery_mode

Sets the Discovery Service mode. The default value is Read / Write.

- ▶ **Read / Write**
This mode will permit the discovery of the Matrix Controller on the network. In addition, the IP settings, description, and other settings for the Matrix Controller can be changed using the Syner-G Software Suite.
- ▶ **Read Only**
This mode only permits the discovery of the Matrix Controller on the network.

Syntax

```
#set_discovery_mode mode
```

Parameters

mode

Type: **INTEGER**

Accepts a number from the table below, specifying the desired mode.

mode	Description
0	Read only
1	Read / Write

Examples

```
#set_discovery_mode 0
DISCOVERY_MODE 0
```

Related Commands

```
#get_discovery
#get_discovery_mode
#set_discovery
```

#set_gateway

Sets the gateway address for the desired port on the Matrix Controller. The gateway address must be typed using dot-decimal notation. The Matrix Controller must be rebooted after executing this command. The default gateway is 192.168.1.254.

Syntax

```
#set_gateway port addr
```

Parameters

port

Type: **INTEGER**

Accepts a number from the table below, specifying the desired port.

port	Description
1	Control Port (LAN 1)
2	Video Port (LAN 2)

addr

Type: **ADDRESS**

The gateway address of the Matrix Controller. This address must be specified in dot-decimal notation.

Example

```
#set_gateway 2 192.168.1.1
GATEWAY 2 192.168.1.1
```

Related Commands

```
#get_gateway          #set_ip_address
#get_ip_address       #set_ip_mode
#get_ip_mode          #set_netmask
#get_ipconfig         #set_port_mode
#get_netmask          #set_web_port
#get_web_port
```

#set_ip_address

Sets the IP address for the desired port on the Matrix Controller. The IP address must be entered using dot-decimal notation. The Matrix Controller must be rebooted after executing this command. The default IP address for the control port (LAN 1) is 192.168.1.74. The default IP address for the video port (LAN 2) is 192.168.1.75.

Syntax

```
#set_ip_address port addr
```

Parameters

port

Type: **INTEGER**

Accepts a number from the table below, specifying the desired port.

port	Description
1	Control Port (LAN 1)
2	Video Port (LAN 2)

addr

Type: **ADDRESS**

The IP address of the Matrix Controller. This address must be specified in dot-decimal notation.

Example

```
#set_ip_address 2 192.168.1.75
IP_ADDRESS 192.168.1.75
```

Related Commands

```
#get_gateway                #set_gateway
#get_ip_address             #set_ip_mode
#get_ip_mode                #set_netmask
#get_ipconfig               #set_port_mode
#get_netmask                #set_web_port
#get_web_port
```

#set_ip_mode

Sets the IP mode from the Control Network to either DHCP or Static. The Video Network IP mode is set to Static and cannot be changed.

Syntax

```
#set_ip_mode port mode
```

Parameters

port

Type: **INTEGER**

Accepts a number from the table below, specifying the desired port.

port	Description
1	Control Port (LAN 1)
2	Video Port (LAN 2)

mode

Type: **INTEGER**

Accepts a number from the table below, specifying the desired mode.

mode	Description
0	Static
1	DHCP

Example

```
#set_ip_mode 1 1
IP_MODE 1 1
```

Related Commands

```
#get_gateway                #set_gateway
#get_ip_address             #set_ip_address
#get_ip_mode                #set_netmask
#get_ipconfig               #set_port_mode
#get_netmask                #set_web_port
#get_web_port
```

#set_mask

Masks the specified output.

Syntax

```
#set_mask ch
```

Parameters

ch

Type: **INTEGER**

The channel number of the output to mask or unmask.

Example

```
#set_mask 3  
MASK ENABLED
```

Related Commands

```
#get_block  
#get_mask  
#set_block
```

#set_netmask

Sets the subnet mask for the desired port on the Matrix Controller. The subnet mask address must be entered using dot-decimal notation. The Matrix Controller must be rebooted after executing this command. The default net mask is 255.255.255.0.

Syntax

```
#set_netmask port addr
```

Parameters

port

Type: **INTEGER**

Accepts a number from the table below, specifying the desired port.

port	Description
1	Control Port (LAN 1)
2	Video Port (LAN 2)

addr

Type: **ADDRESS**

The subnet mask of the Matrix Controller. This address must be specified in dot-decimal notation.

Example

```
#set_netmask 2 255.255.0.0
NETMASK 2 255.255.255.0
```

Related Commands

```
#get_gateway           #set_gateway
#get_ip_address        #set_ip_address
#get_ip_mode           #set_ip_mode
#get_ipconfig          #set_port_mode
#get_netmask           #set_web_port
#get_web_port
```

#set_port_mode

Sets the network port mode on the Matrix Controller.

Syntax

```
#set_port_mode mode
```

Parameters

mode

Type: **INTEGER**

Accepts a number from the table below, specifying the desired port mode.

mode	Description
0	Combined
1	Separate

Example

```
#set_port_mode  
SET_PORT_MODE 1
```

#set_showme

Enables or disables the “Show Me” feature. When the “Show Me” feature is enabled several of the button on the front panel will flash. This quickly identifies a unit and is useful when multiple units are being used. The default setting is disabled.

Syntax

```
#set_showme state
```

Parameters

state

Type: **INTEGER**

Accepts a number from the table below, specifying the desired state.

state	Description
0	Disabled
1	Enabled

Example

```
#set_showme 1  
SHOWME 1
```

Related Commands

```
#get_discovery  
#get_discovery_mode  
#set_discovery  
#set_discovery_mode
```

#set_telnet_access

Enables or disables Telnet access. The default setting is enabled.

Syntax

```
#set_telnet_access state
```

Parameters

state

Type: **INTEGER**

Accepts a number from the table below, specifying the desired state.

state	Description
0	Disabled
1	Enabled

Example

```
#set_telnet_access 1  
TELNET_ACCESS 1
```

Related Commands

```
#get_telnet_access  
#get_telnet_pass  
#get_telnet_port  
#set_telnet_port  
#use_telnet_login  
#use_telnet_welcome
```

#set_telnet_port

Sets the Telnet listening port. The default port is 23.

Syntax

```
#set_telnet_port port
```

Parameters

port

Type: **INTEGER**

The Telnet listening port. The port number can be between 0 and 65535.

Example

```
#set_telnet_port 23  
TELNET_PORT 23
```

Related Commands

```
#get_telnet_access  
#get_telnet_pass  
#get_telnet_port  
#set_telnet_access  
#use_telnet_login  
#use_telnet_welcome
```

#set_udp_access

Enables or disables UDP access. The default setting is enabled.

Syntax

```
#set_udp_access state
```

Parameters

state

Type: **INTEGER**

Accepts a number from the table below, specifying the desired state.

state	Description
0	Disabled
1	Enabled

Example

```
#set_udp_access 1  
UDP_ACCESS 1
```

Related Commands

```
#get_udp_access  
#get_udp_echo_access  
#get_udp_echo_ip  
#get_udp_echo_port  
#get_udp_port  
#set_udp_echo_access  
#set_udp_echo_ip  
#set_udp_echo_port  
#set_udp_port
```

#set_udp_echo_access

Enables or disables UDP echo.

Syntax

```
#set_udp_echo_access state
```

Parameters

state

Type: **INTEGER**

Accepts a number from the table below, specifying the desired state.

state	Description
0	Disabled
1	Enabled

Example

```
#set_udp_echo_access 0
UDP_ECHO_ACCESS 0
```

Related Commands

```
#get_udp_access
#set_udp_access
#get_udp_echo_access
#set_udp_echo_access
#get_udp_echo_ip
#set_udp_echo_ip
#get_udp_echo_port
#set_udp_echo_port
#get_udp_port
#set_udp_port
```

#set_udp_echo_ip

Sets the UDP echo IP address. The IP address must be entered using dot-decimal notation.

Syntax

```
#set_udp_echo_ip addr
```

Parameters

addr

Type: **ADDRESS**

The UDP IP address which will receive the echo response.

Example

```
#set_udp_echo_ip 10.5.64.158  
UDP_ECHO_IP 10.5.64.158
```

Related Commands

```
#get_udp_access  
#get_udp_echo_access  
#get_udp_echo_ip  
#get_udp_echo_port  
#get_udp_port  
#set_udp_access  
#set_udp_echo_access  
#set_udp_echo_port  
#set_udp_port
```

#set_udp_echo_port

Sets the UDP echo communication port.

Syntax

```
#set_udp_echo_port port
```

Parameters

port

Type: **INTEGER**

The UDP echo port. The port number can be between 0 and 65535.

Example

```
#set_udp_echo_port  
UDP_ECHO_PORT 50009
```

Related Commands

```
#get_udp_access  
#get_udp_echo_access  
#get_udp_echo_ip  
#get_udp_echo_port  
#get_udp_port  
#set_udp_access  
#set_udp_echo_access  
#set_udp_echo_ip  
#set_udp_port
```

#set_udp_port

Sets the UDP listening port. The default port is 50007.

Syntax

```
#set_udp_port port
```

Parameters

port

Type: **INTEGER**

The UDP port. The port number can be from 0 to 65535.

Example

```
#set_udp_port 50008  
UDP_PORT 50008
```

Related Commands

```
#get_udp_access  
#get_udp_echo_access  
#get_udp_echo_ip  
#get_udp_echo_port  
#get_udp_port  
#set_udp_access  
#set_udp_echo_access  
#set_udp_echo_ip  
#set_udp_port
```

#set_web_port

Sets the HTTP listening port for the built-in web interface on the Matrix Controller. The Matrix Controller must be rebooted after executing this command. The default port setting is 80.

Syntax

```
#set_web_port port
```

Parameters

port

Type: **INTEGER**

The HTTP listening port. The port number can be from 0 to 65535.

Example

```
#set_web_port 80  
WEB_PORT 80
```

Related Commands

```
#get_gateway  
#get_ip_address  
#get_ip_mode  
#get_ipconfig  
#get_netmask  
#get_web_port  
#set_gateway  
#set_ip_address  
#set_ip_mode  
#set_netmask  
#set_port_mode
```

#use_telnet_login

Enables or disables the requirement of login credentials for a Telnet session.

Syntax

```
#use_telnet_login state
```

Parameters

state

Type: **INTEGER**

Accepts a number from the table below, specifying the desired state.

state	Description
0	Disabled
1	Enabled

Example

```
#use_telnet_login  
TELNET_LOGIN 1
```

Related Commands

```
#get_telnet_access  
#get_telnet_pass  
#get_telnet_port  
#set_telnet_access  
#set_telnet_port  
#use_telnet_welcome
```

#use_telnet_welcome

Enables or disables the Telnet welcome message. When enabled, the following message will be displayed at the beginning of each Telnet session: `Welcome to EXT-CU-LAN Telnet: This message is enabled, by default.` The message may be disabled for communications with some control systems.

Syntax

```
#use_telnet_welcome state
```

Parameters

state

Type: **INTEGER**

Accepts a number from the table below, specifying the desired state.

state	Description
0	Disabled
1	Enabled

Example

```
#use_telnet_welcome 1  
TELNET_WELCOME 1
```

Related Commands

```
#get_telnet_access  
#get_telnet_pass  
#get_telnet_port  
#set_telnet_access  
#set_telnet_port  
#use_telnet_login
```

p

Recalls the specified preset number. Do not precede this command with the “#” symbol.

Syntax

```
p preset
```

Parameters

```
preset
```

Type: **INTEGER**

The desired preset. This number can be from 1 to 9999.

Example

```
p 2  
p 2
```

r

Routes an input to the specified output(s). Do not precede this command with the “#” symbol.

Syntax

```
r inch outid
```

Parameters

inch

Type: **INTEGER**

The desired input channel. This number can be from 1 to 255.

outid

Type: **INTEGER**

The desired output ID. This number can be from 1 to 65535.

Example

```
r 1 4  
r 1 4
```

This page left intentionally blank.

Matrix Controller

4

Appendix

Updating the Matrix Controller



Information

The firmware upgrade procedure can take up to 15 minutes to complete.

1. Download the latest version of firmware from the Gefen Web site.
2. Extract the .bin file from the .ZIP file.
3. Access the built-in Web interface and click the **System** tab.
4. Click the **Browse...** button and select the firmware file.

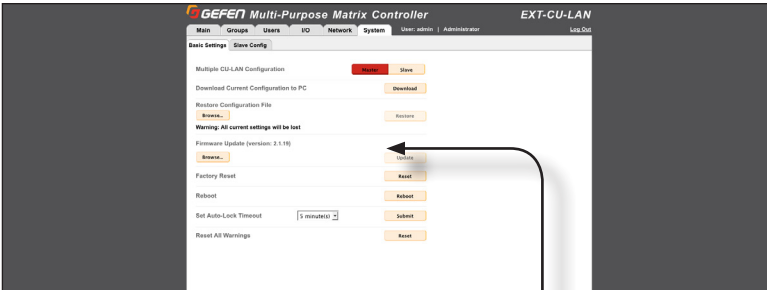

Warning: All current settings will be lost

Firmware Update (version: 2.1.19)

Browse...

5. Click the **Update** button.



date (version: 2.1.19)

EXT-CU-LAN_2.1.19.bin

Update

(continued on next page)

6. The following message box will be displayed:

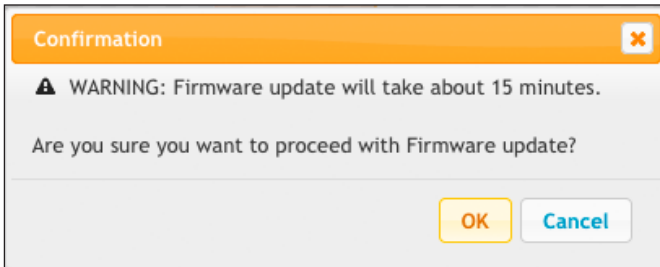

Click the **OK** button to continue. Click the **Cancel** button to cancel the operation.

7. Another message box will be displayed, indicating that the upgrade process can take up to 15 minutes to complete.

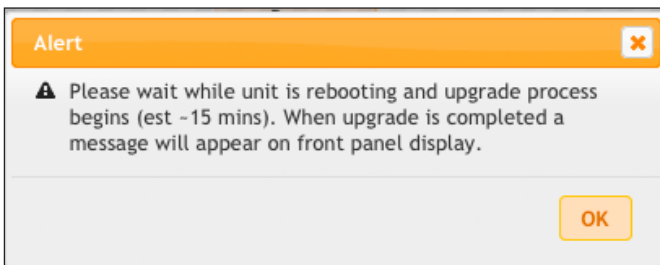

8. Click the **OK** button to acknowledge and dismiss the message box.
9. The display on the front panel will display the following set of similar messages during the upgrade process:

```
REBOOTING...
```

```
FIRMWARE UPGRADE
APPLIED. REBOOTING.
```

```
FIRMWARE UPGRADE
BUILDING FW FILE
```

```
FIRMWARE UPGRADE
RESTORING SETTINGS
```

```
FIRMWARE UPGRADE
APPLYING FIRMWARE
```

```
FIRMWARE UPGRADE
FINISHED. REBOOTING.
```

10. After the firmware upgrade process has completed, the *passcode screen* will be displayed:



ENTER PASSCODE:

Updating Sender and Receiver Units

Up to 10 Sender and Receiver units can be updated, simultaneously, using the Matrix Controller. This process can be performed automatically or manually. We will cover the automatic method, first.

► Automatic Method

1. Login to the web interface as **Admin**.
2. Click the **I/O** tab.

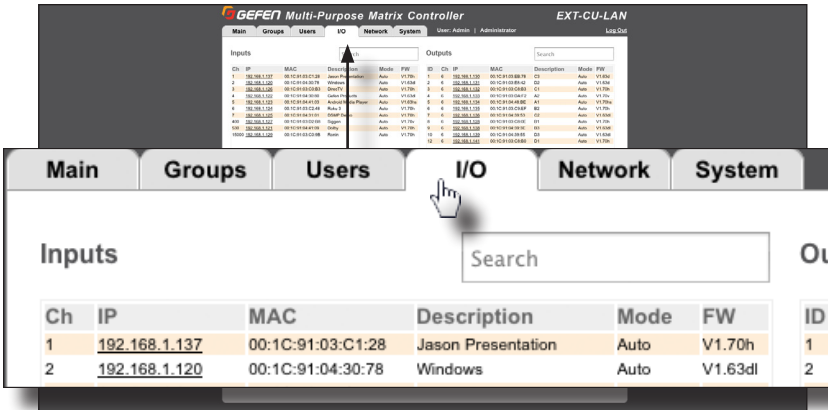

3. Click the desired Sender and/or Receiver units, to be updated, under the **Inputs** and/or **Outputs** column. The selected units will be highlighted in red.

To select all Sender and Receiver units, click the **Select All** button.

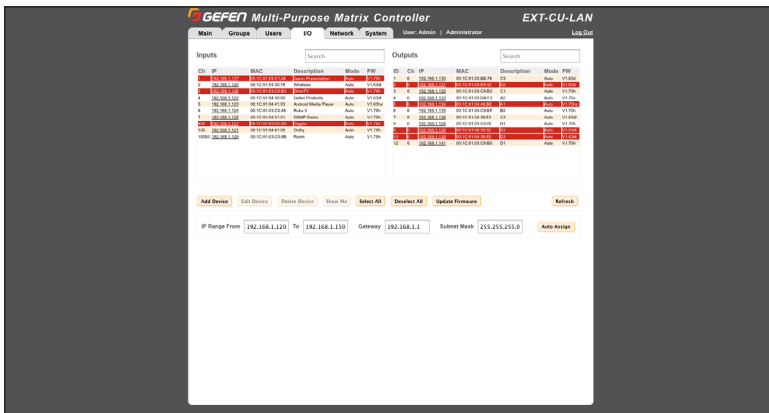

- Click the **Update Firmware** button.



- The **Update Firmware** dialog will be displayed. Click the drop-down list next to **Devices to update simultaneously** to optionally select the number of devices to update at once: **2**, **5**, or **10**. This step is optional.

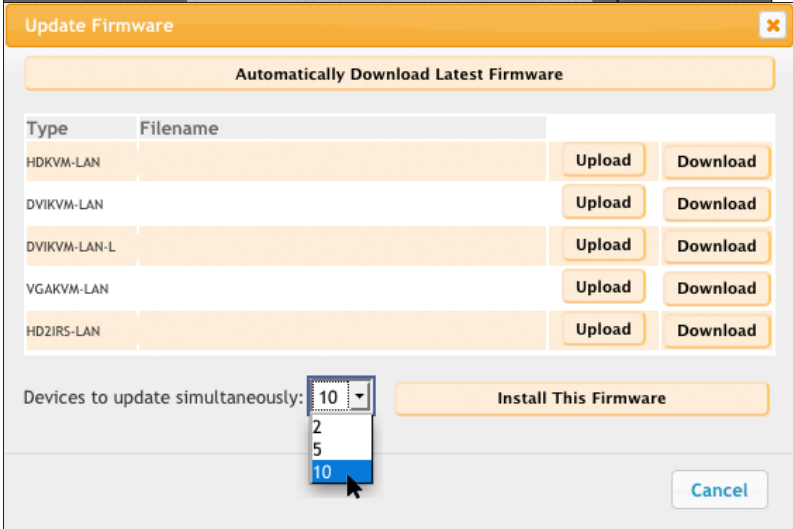
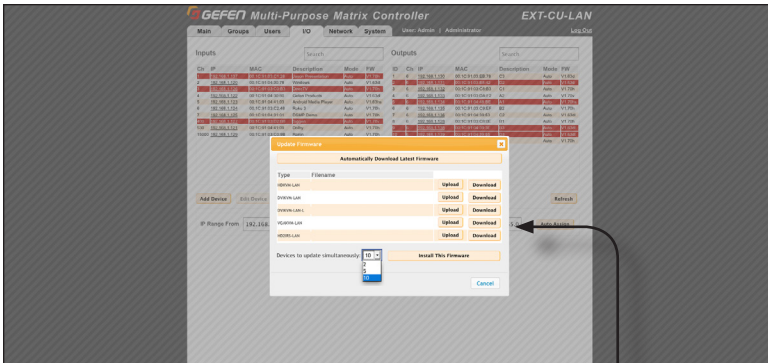

6. Click the **Automatically Download Latest Firmware** button.

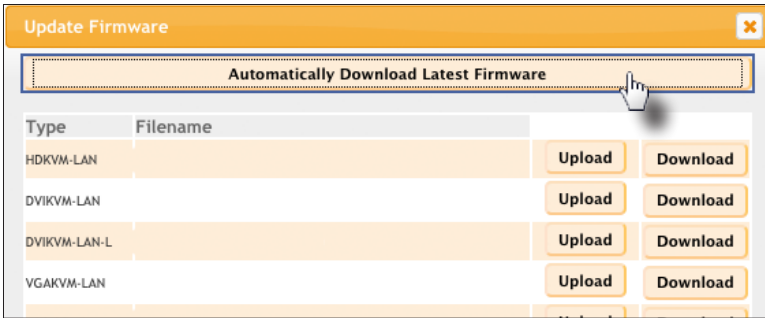

7. The following message will appear as the firmware is downloaded from the Gefen web site.

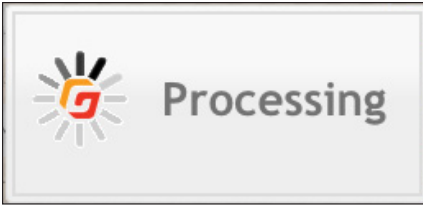

8. After the required firmware is downloaded, the name of each firmware file will appear under the **Filename** column of the **Update Firmware** dialog.

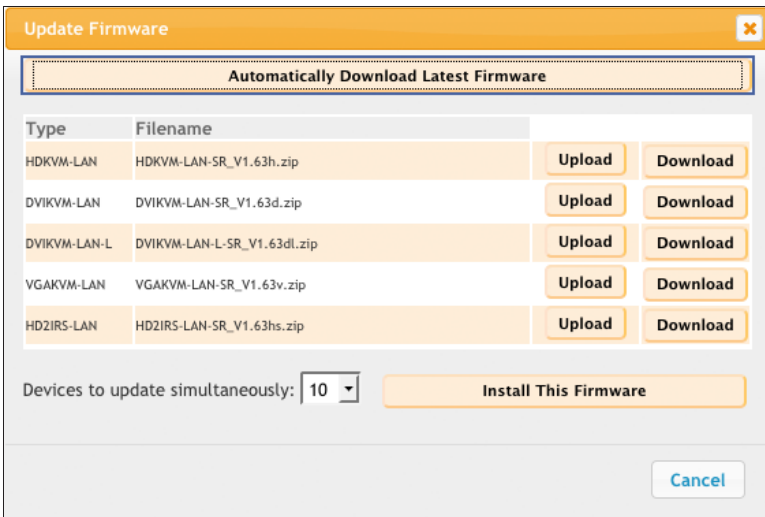

9. Click the **Install This Firmware** button. If you wish to save the firmware file to your computer, click the **Download** button.

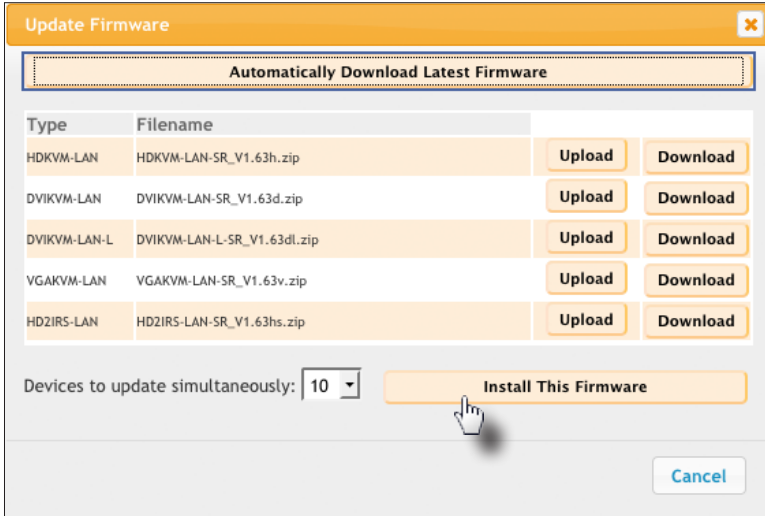

10. The **Firmware Update Status** dialog will be displayed and will show the current status of the update process.

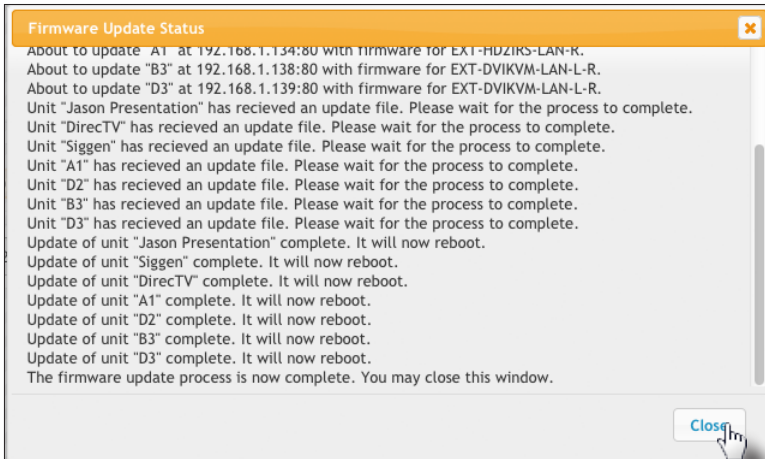

11. Once the firmware update process has completed, noted by the message at the bottom of the window, click the **Close** button on the **Update Firmware** dialog.

► Custom Method

1. Download the latest firmware for the desired unit(s) connected to the Matrix Controller.
2. Login to the web interface as **Admin**.
3. Click the **I/O** tab.

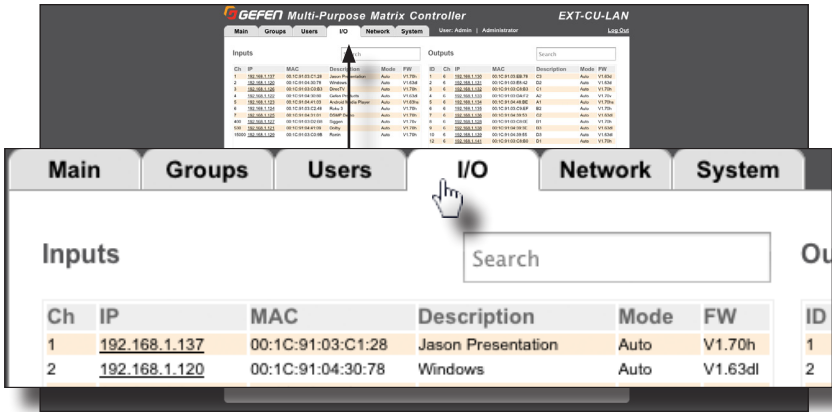

4. Click the desired Sender and/or Receiver units, to be updated, under the **Inputs** and/or **Outputs** column. The selected units will be highlighted in red.

To select all Sender and Receiver units, click the **Select All** button.

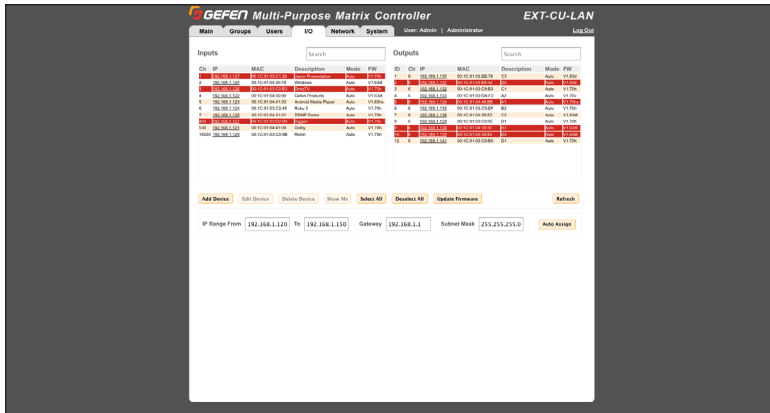

- Click the **Install This Firmware** button.



- The **Update Firmware** dialog will be displayed. Click the drop-down list next to **Devices to update simultaneously** to optionally select the number of devices to update at once: **2, 5, or 10**. This step is optional and depends upon the number of units that you are manually updating, simultaneously.

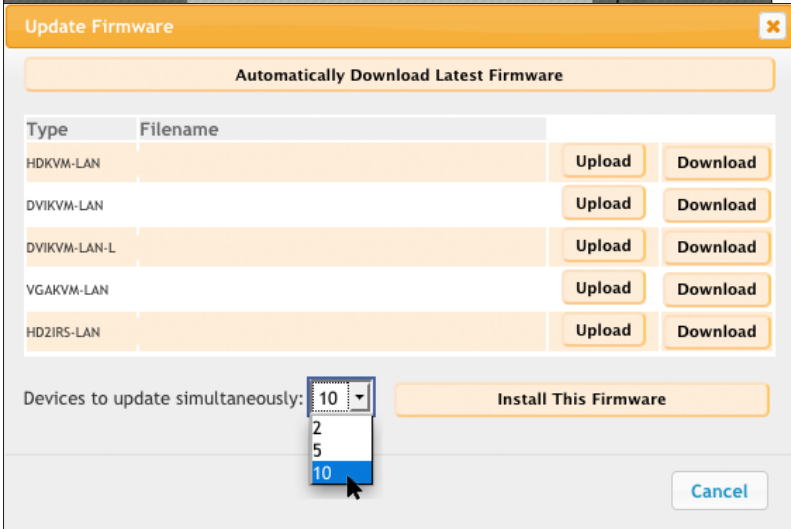
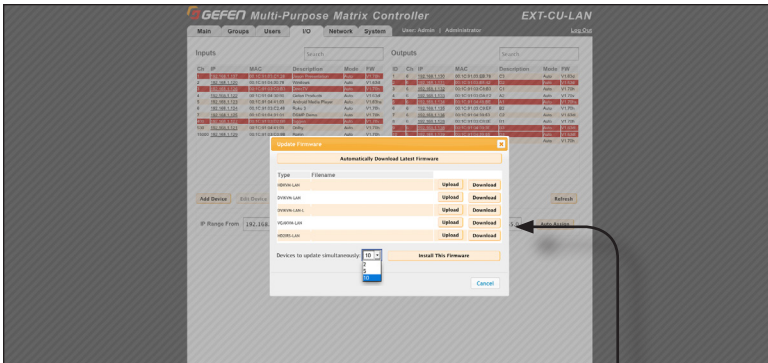

7. Locate the unit that is being updated, under the **Type** column of the **Update Firmware** dialog, and click the **Upload** button.

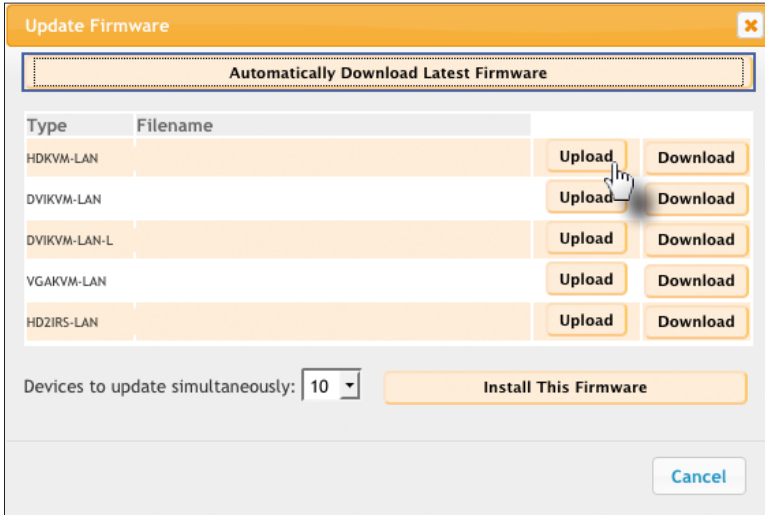

8. On the **File Upload** dialog that is displayed, select the firmware file on the computer and select the **Open** button.
9. The selected file will appear under the **Filename** column of the **Update Firmware** dialog.

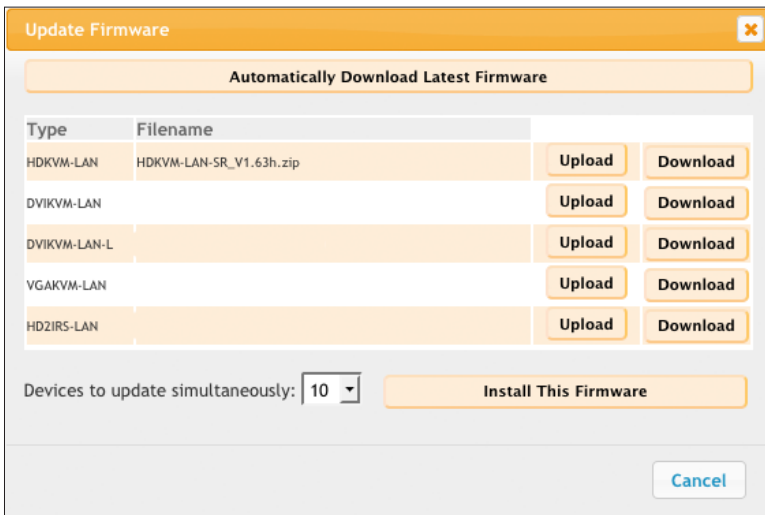

- Click the **Install This Firmware** button.

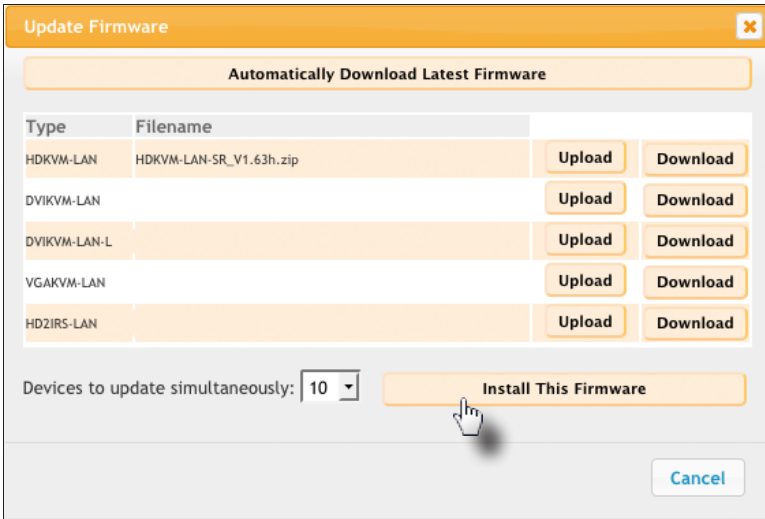

- The **Firmware Update Status** dialog will be displayed and will show the current status of the update process.
- Once the firmware update process has completed, noted by the message at the bottom of the window, click the **Close** button on the **Update Firmware** dialog.

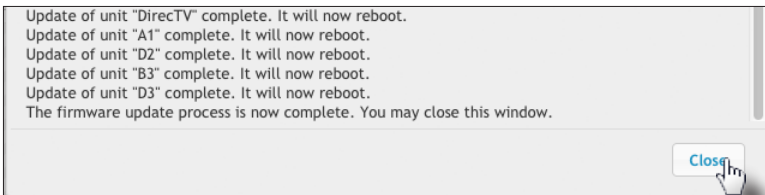

If you wish to save the firmware file to your computer, click the **Download** button.

Menu System Summary

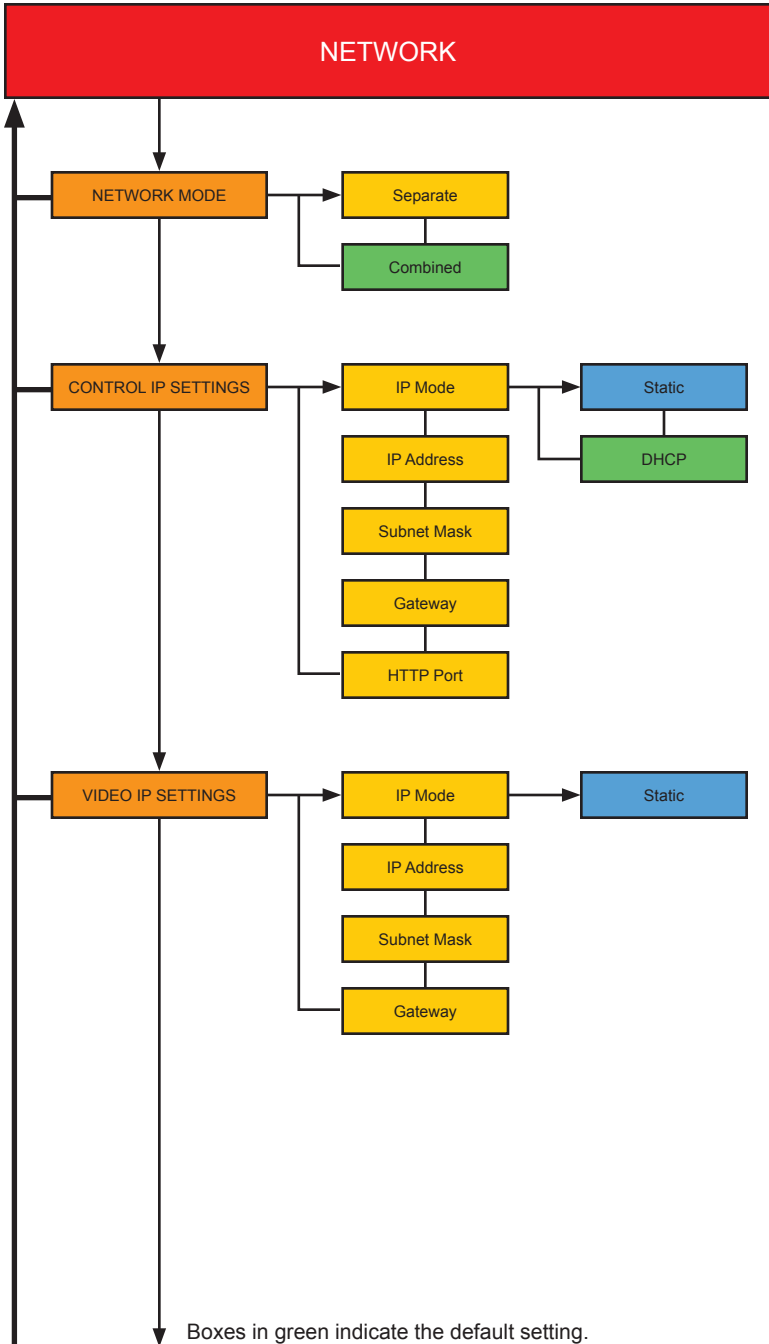

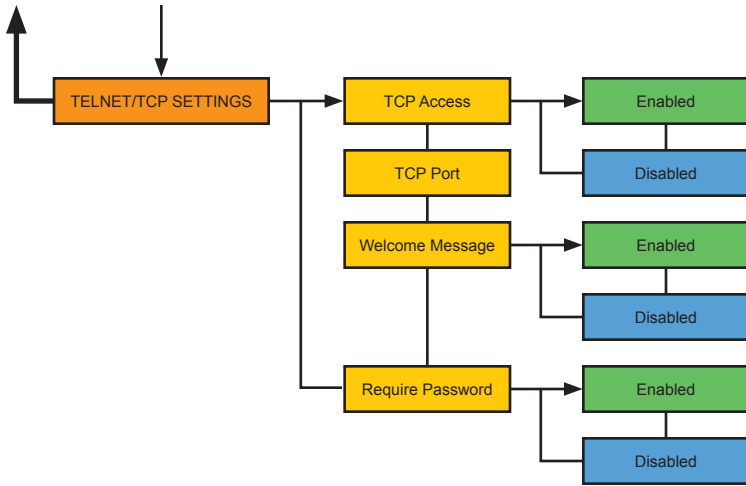

Boxes in green indicate the default setting.

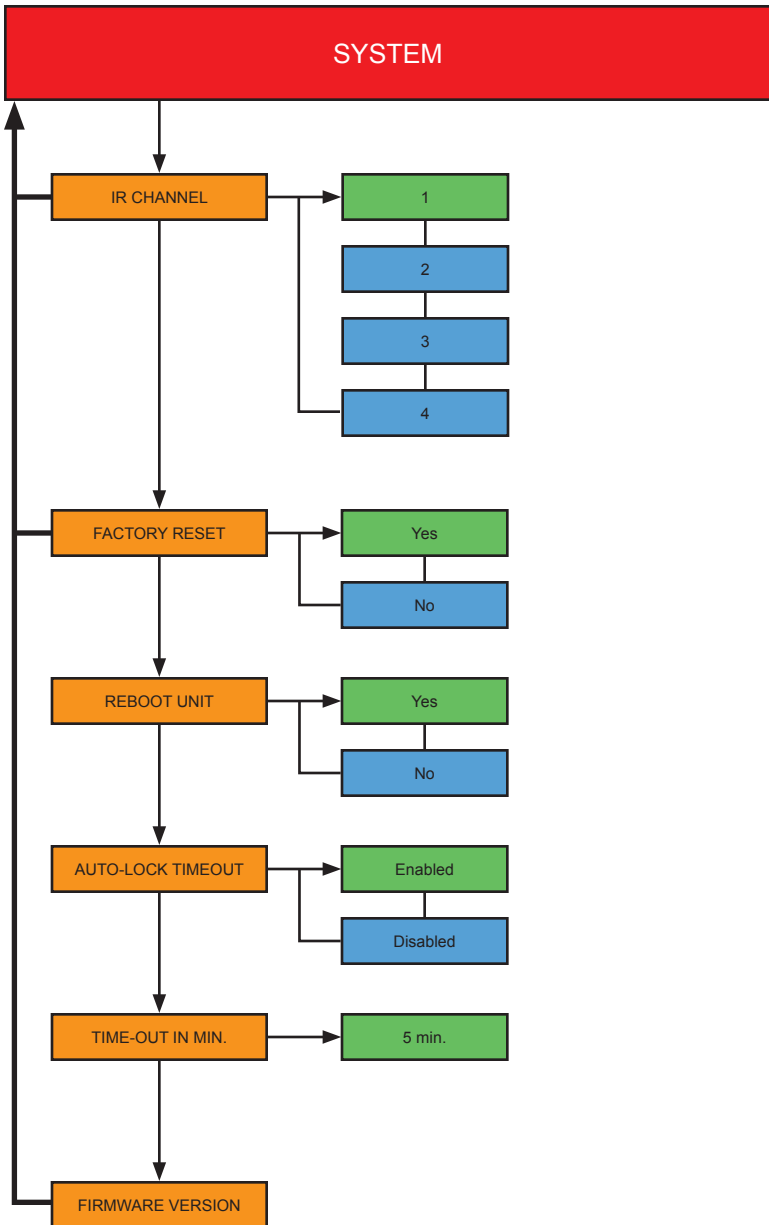

Boxes in green indicate the default setting.

Connectors, Controls, and Indicators

LAN 1	<ul style="list-style-type: none"> 1 x RJ-45, POE-enabled
LAN 2	<ul style="list-style-type: none"> 1 x RJ-45
Power Connector	<ul style="list-style-type: none"> 1 x locking
Front-panel buttons	<ul style="list-style-type: none"> 28 x push button, tact-type
IR Sensor	<ul style="list-style-type: none"> 1 x sensor, front panel
Display	<ul style="list-style-type: none"> 1 x LCM display 2 lines, 20 characters per line
Power Indicator	<ul style="list-style-type: none"> 1 x LED, blue

Operational

Power Input	<ul style="list-style-type: none"> 5V DC
Power Consumption	<ul style="list-style-type: none"> 4.3W (max.)
Operating Temperature	<ul style="list-style-type: none"> +32 to +122 °F (0 to +50 °C)
Operating Humidity	<ul style="list-style-type: none"> 5% to 90% RH, non-condensing
Storage Temperature	<ul style="list-style-type: none"> -4 to +185 °F (-20 to +85 °C)
Storage Humidity	<ul style="list-style-type: none"> 0% to 95% RH, non-condensing
MTBF	<ul style="list-style-type: none"> 50000 Hours

Physical

Dimensions (W x H x D) without rack ears	<ul style="list-style-type: none"> 17" x 3.5" x 2.7" (432mm x 88mm x 68mm)
Dimensions (W x H x D) with rack ears	<ul style="list-style-type: none"> 19" x 3.5" x 2.7" (482mm x 88mm x 68mm)
Unit Weight	<ul style="list-style-type: none"> 3.7 lbs (1.7 kg)

A

Accessing

- menu system 75

Access level 142

- setting 31, 151

Adding

- groups. *See* Creating: groups

- inputs 42

- outputs 42, 89

- users 47

Administrator. *See* Users: creating

B

Blocking

- inputs 54

C

Changing

- passcode 34

Combined Mode 9

Commands

- #factory_reset 172

- #get_block 173

- #get_discovery 174

- #get_discovery_mode 175

- #get_firmware_version 176

- #get_gateway 177

- #get_ip_address 178

- #get_ipconfig 180

- #get_ip_mode 179

- #get_mask 181

- #get_netmask 182

- #get_telnet_access 183

- #get_telnet_pass 184

- #get_telnet_port 185

- #get_udp_access 186

- #get_udp_echo_access 187

- #get_udp_echo_ip 188

- #get_udp_echo_port 189

- #get_udp_port 190

- #get_web_port 191

- #help 192

- p 214

- r 215

- #reboot 193

- #set_block 194

- #set_discovery 195

- #set_discovery_mode 196

- #set_gateway 197

- #set_ip_address 198

- #set_ip_mode 199

- #set_mask 200

- #set_netmask 201

- #set_port_mode 202

- #set_showme 203

- #set_telnet_access 204

- #set_telnet_port 205

- #set_udp_access 206

- #set_udp_echo_access 207

- #set_udp_echo_ip 208

- #set_udp_echo_port 209

- #set_udp_port 210

- #set_web_port 211

- #use_telnet_login 212

- #use_telnet_welcome 213

Creating

- groups 38

- members. *See* Creating: users

- users 30

D

Default Group 36

Deleting

- groups 40

- inputs and outputs. *See* Removing: inputs and outputs

- members. *See* Removing: members

- users 33

Destination

- UDP IP address. *See* UDP Settings: remote UDP address

- UDP port. *See* UDP Settings: remote UDP port

Device Configuration 20

Discovery Service

- enabling / disabling 161

- find device 161

- product description 162

- read / write status 125

- settings 124

E

Editing

- groups* 41
- users* 34

F

Factory settings

- setting. See Resetting the Matrix Controller*

Features *viii*

Firmware upgrade procedure 218

Front panel

- layout* 2
- lockout* 129
- timeout* 131, 164

GGroup Administrator. *See* Users: creating Groups

- adding inputs and outputs* 42
- adding users* 47
- creating* 38
- Default* 36
- deleting* 40
- editing* 41
- overview* 28
- presets*
 - creating* 66
- removing inputs and outputs* 45
- removing members* 49

H

HTTP Port 105, 157

I

Index 233

Inputs

- adding* 42
- blocking* 54
- removing* 45

Installation 9

Introduction 2

IP Settings

control

- gateway* 104
- HTTP port* 105
- IP address* 102
- IP mode* 101
- setting* 100
- subnet mask* 103

video

- gateway* 111
- IP address* 108
- IP mode* 108
- setting* 107
- subnet mask* 110

IR channel

- setting*
 - matrix controller* 127

IR Remote Control

- layout* 5

LLicensing *vii*

Lock

- button. See Panel layout*

Locking the Matrix Controller 140

Lockout

- front panel* 129

Logout 142

M

MAC Address 157, 158

masking 56

Matrix View 58

Members

- overview* 28

Menu

- button. See Panel layout*
- system*
 - accessing* 75
 - summary* 229

Mode

- combined* 9
- separate* 13

N

- Network Mode
 - combined* 9
 - separate* 9
 - setting* 97, 157

O

- Operating Notes v
- Operator. *See* Users: creating
- Outputs
 - adding* 89
 - masking* 56, 91, 144
 - removing* 45

P

- Packing List *viii*
- Panel layout 2
- Passcode
 - changing* 34
 - default* 10, 14
- Presets
 - creating*
 - group* 66
 - user* 63
 - quick*. *See* Quick presets
 - selecting* 93

Q

- Quick presets
 - creating* 70
 - editing* 72
 - using* 74

R

- Rebooting the Matrix Controller 137
- Removing
 - inputs and outputs* 45
 - members* 49
- Resetting the Matrix Controller 133
- Routing
 - inputs to outputs* 51, 78
 - outputs to inputs* 53, 84

S

- Separate Mode 13
- Specifications 232
- Subnet Mask 110

T

- Table of Contents *ix*
- Technical Support *iv*
- Telnet / TCP Settings 113
 - require password* 117
 - TCP access* 114, 159
 - TCP port* 114, 159
 - welcome message* 116, 159
- Timeout
 - front panel* 131, 164

U

- UDP Settings 118
 - Destination UDP IP Address. See* UDP Settings: *remote UDP address*
 - Destination UDP Port. See* UDP Settings: *remote UDP port*
 - remote UDP access* 121
 - remote UDP address* 122, 160
 - remote UDP port* 122, 160
 - UDP access* 119, 160
 - UDP echo* 160
 - UDP port* 120, 160
- Unlocking the Matrix Controller 140
- Updating Firmware
 - Matrix Controller* 218
 - Sender and Receiver*
 - Automatic Method* 221
 - Custom Method* 225

Users

- creating* 30
- deleting* 33
- editing* 34
- overview* 28
- presets*
 - creating* 63

W

- Web Interface
 - groups tab*

Appendix

- inputs / outputs* 147
- members* 148
- I/O tab* 152
- main tab* 147
- network tab*
 - discovery* 161
 - IP* 157
 - TCP* 159
 - UDP* 160
- system tab* 163, 165
- users tab* 152
- Welcome Message 116

This page left intentionally blank.



20600 Nordhoff St., Chatsworth CA 91311
1-800-545-6900 818-772-9100 fax: 818-772-9120
www.gefen.com support@gefen.com