

DVI ELR Lite

Extender over
one CAT-5

EXT-DVI-1CAT5-SR

User Manual

Release A1



Important Safety Instructions

GENERAL SAFETY INFORMATION

1. Read these instructions.
2. Keep these instructions.
3. Heed all warnings.
4. Follow all instructions.
5. Do not use this product near water.
6. Clean only with a dry cloth.
7. Do not block any ventilation openings. Install in accordance with the manufacturer's instructions.
8. Do not install or place this product near any heat sources such as radiators, heat registers, stoves, or other apparatus (including amplifiers) that produce heat.
9. Do not defeat the safety purpose of the polarized or grounding-type plug. A polarized plug has two blades with one wider than the other. A grounding type plug has two blades and a third grounding prong. The wide blade or the third prong are provided for your safety. If the provided plug does not fit into your outlet, consult an electrician for replacement of the obsolete outlet.
10. Protect the power cord from being walked on or pinched particularly at plugs, convenience receptacles, and the point where they exit from the apparatus.
11. Only use attachments/accessories specified by the manufacturer.
12. To reduce the risk of electric shock and/or damage to this product, never handle or touch this unit or power cord if your hands are wet or damp. Do not expose this product to rain or moisture.
13. Unplug this apparatus during lightning storms or when unused for long periods of time.
14. Refer all servicing to qualified service personnel. Servicing is required when the apparatus has been damaged in any way, such as power-supply cord or plug is damaged, liquid has been spilled or objects have fallen into the apparatus, the apparatus has been exposed to rain or moisture, does not operate normally, or has been dropped.
15. Batteries that may be included with this product and/or accessories should never be exposed to open flame or excessive heat. Always dispose of used batteries according to the instructions.

Warranty Information

Gefen warrants the equipment it manufactures to be free from defects in material and workmanship.

If equipment fails because of such defects and Gefen is notified within two (2) years from the date of shipment, Gefen will, at its option, repair or replace the equipment, provided that the equipment has not been subjected to mechanical, electrical, or other abuse or modifications. Equipment that fails under conditions other than those covered will be repaired at the current price of parts and labor in effect at the time of repair. Such repairs are warranted for ninety (90) days from the day of reshipment to the Buyer.

This warranty is in lieu of all other warranties expressed or implied, including without limitation, any implied warranty or merchantability or fitness for any particular purpose, all of which are expressly disclaimed.

1. Proof of sale may be required in order to claim warranty.
2. Customers outside the US are responsible for shipping charges to and from Gefen.
3. Copper cables are limited to a 30 day warranty and cables must be in their original condition.

The information in this manual has been carefully checked and is believed to be accurate. However, Gefen assumes no responsibility for any inaccuracies that may be contained in this manual. In no event will Gefen be liable for direct, indirect, special, incidental, or consequential damages resulting from any defect or omission in this manual, even if advised of the possibility of such damages. The technical information contained herein regarding the features and specifications is subject to change without notice.

For the latest warranty coverage information, refer to the Warranty and Return Policy under the Support section of the Gefen Web site at www.gefen.com.

PRODUCT REGISTRATION

Please register your product online by visiting the Register Product page under the Support section of the Gefen Web site.

Contacting Gefen Technical Support

Gefen, LLC
c/o Customer Service
20600 Nordhoff St.
Chatsworth, CA 91311

Telephone: (818) 772-9100
(800) 545-6900

Fax: (818) 772-9120

Email: support@gefen.com

Visit us on the Web: www.gefen.com

Technical Support Hours: 8:00 AM to 5:00 PM Monday - Friday, Pacific Time

DVI ELR Lite Extender over one CAT-5 is a trademark of Gefen, LLC.

Important Notice

Gefen, LLC reserves the right to make changes in the hardware, packaging, and any accompanying documentation without prior written notice.

© 2013 Gefen, LLC. All Rights Reserved.
All trademarks are the property of their respective owners.

Operating Notes

- CAT-5 cables should not exceed 200 feet (60 meters). CAT-6 cables should not exceed 230 feet (70 meters).
- Shielded Twisted-Pair (STP) CAT-5 or CAT-6 cabling is recommended. However, Un-shielded Twisted-Pair (UTP) CAT-5 or CAT-6 cabling is acceptable. Shielded cable has an advantage by providing immunity to Electromagnetic Interference (EMI), cell phones and A/C motors.

Features and Packing List

Features

- Extends DVI up to 230 feet (70 meters) over one CAT-6A cable
- Extends DVI up to 200 feet (60 meters) over one CAT-5e cable
- Supports resolutions up to 1080p Full HD and 1920 x 1200 (WUXGA)
- EDID management for rapid integration of source and display
- Enable/Disable switches for HDCP and HPD pass-through
- Locking power supplies
- Surface-mountable



Packing List

The DVI ELR Lite Extender over one CAT-5 ships with the items listed below. If any of these items are not present in your box when you first open it, immediately contact your dealer or Gefen.

- 1 x DVI ELR Lite Extender over one CAT-5 (Sender unit)
- 1 x DVI ELR Lite Extender over one CAT-5 (Receiver unit)
- 1 x 6 ft. dual-link DVI cable (M-M)
- 2 x 5V / 2.6A DC locking power supply
- 1 x Quick-Start Guide

Table of Contents

01 Getting Started

Sender Unit Layout.....	2
Front Panel.....	2
Back Panel.....	3
Bottom Panel.....	4
Receiver Unit Layout.....	5
Front Panel.....	5
Back Panel.....	6
Installation.....	7
Connecting the DVI ELR Lite Extender over one CAT-5.....	7
Sample Wiring Diagram.....	7

02 Appendix

DIP Switch Configuration.....	10
Specifications.....	11

DVI ELR Lite

Extender over
One CAT-5

01 Getting Started

- Sender Unit Layout..... 2
 - Front Panel..... 2
 - Back Panel..... 3
 - Bottom Panel..... 4
- Receiver Unit Layout..... 5
 - Front Panel..... 5
 - Back Panel..... 6
- Installation 7
 - Connecting the DVI ELR Lite Extender over one CAT-5 7
 - Sample Wiring Diagram 7

Sender Unit Layout

Front Panel

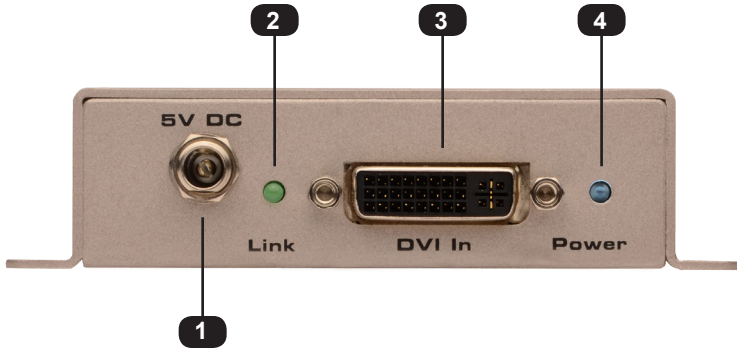

ID	Name	Description
1	5V DC	Connect the included 5V DC power supply to this power receptacle.
2	Link	<p>This LED indicator will glow bright green when power is applied and a CAT-5 cable is connected between the Sender and Receiver unit.</p> <p>If the source is not connected to the Sender unit, then this LED indicator will flash bright green.</p>
3	DVI In	Connect the DVI source to this port using the included DVI cable.
4	Power	This LED will glow bright blue when the unit is powered.

Back Panel

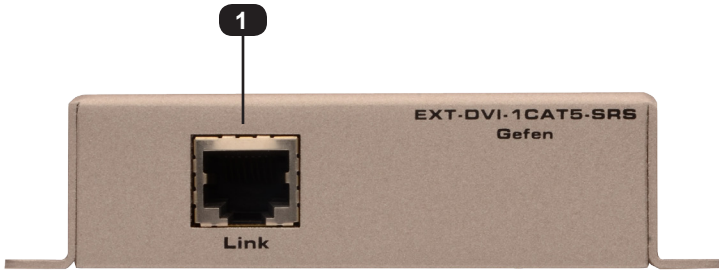

ID	Name	Description
1	Link	Connect a CAT-5 cable from this jack to the Link jack on the Receiver unit.

Bottom Panel

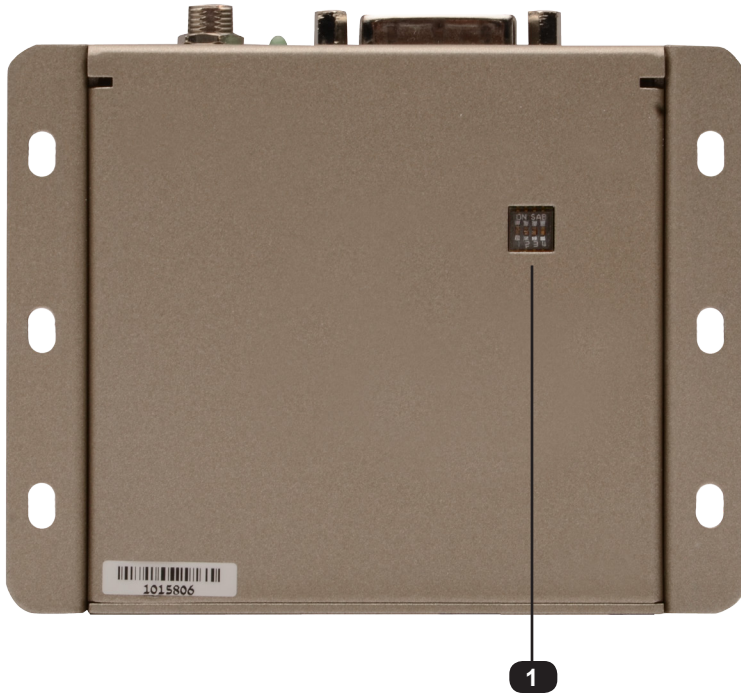

ID	Name	Description
1	DIP switches	Used for troubleshooting purposes only. See DIP Switch Configuration for more information.

Receiver Unit Layout

Front Panel

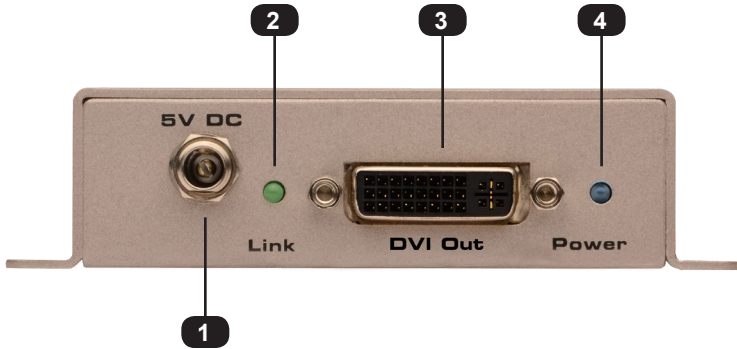

ID	Name	Description
1	5V DC	Connect the included 5V DC power supply to this power receptacle.
2	Link	<p>This LED indicator will glow bright green when power is applied and a CAT-5 cable is connected between the Sender and Receiver unit.</p> <p>If the display (sink) is not connected to the Receiver unit, then this LED indicator will flash bright green.</p>
3	DVI In	Connect the DVI source to this port using the included DVI cable.
4	Power	This LED will glow bright blue when the unit is powered.

Back Panel

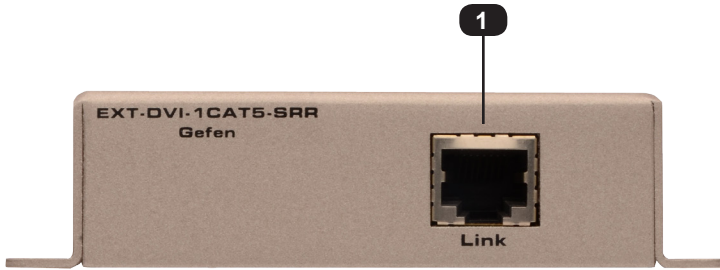

ID	Name	Description
1	Link	Connect a CAT-5 (or better) cable from this jack to the Link jack on the Sender unit.

Installation

Connecting the DVI ELR Lite Extender over one CAT-5

1. Use the included DVI cable to connect the DVI source to the **DVI In** port on the Sender unit.
2. Connect the Receiver unit to the display using another DVI cable.
3. Connect a CAT-5 (CAT-5e or better is recommended) cable, up to 200 feet (60 meters) from the **Link** jack on the Sender unit to the **Link** jack on the Receiver unit.

If CAT-6a cable is being used, then the cable length can be up to 230 feet (70 meters).
4. Connect the included 5V DC locking power supplies to the Sender and Receiver unit. Do not overtighten the locking power connectors.
5. Connect the AC power cord from the power supply to an available electrical outlet.

Sample Wiring Diagram

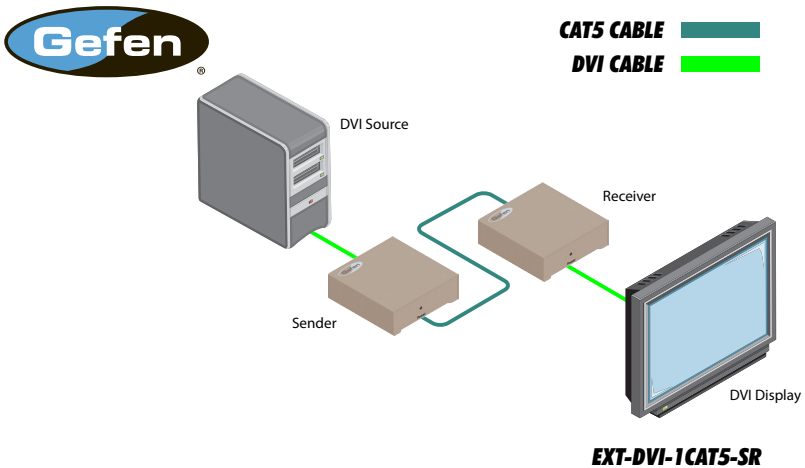

DVI ELR Lite

Extender over
One CAT-5

02 Appendix

DIP Switch Configuration	10
Specifications	11

DIP Switch Configuration

On the bottom panel of the DVI ELR Lite Extender over one CAT-5 are a bank of 4 DIP switches. Remove the piece of colored tape to reveal the DIP switch bank. These DIP switches provide control over EDID management, Hot-Plug Detect, and HDCP. DIP switch 4 is not used. These DIP switches are used for troubleshooting purposes, only.

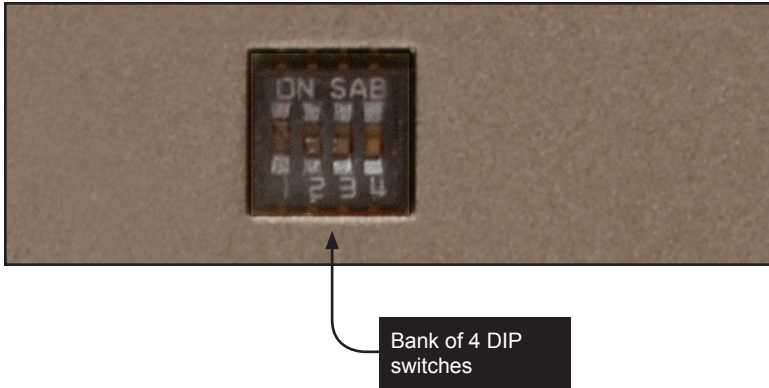

DIP Switch	Setting	Description
1	OFF	Uses the local (internal) EDID instead of the downstream EDID (from the display). This EDID provides generic video/audio support which is compatible with most displays.
	ON (default)	Uses the downstream EDID. Both DDC and HPD (Hot-Plug Detect) are passed through, allowing the full audio/video capabilities of the display to be used.
2	OFF (default)	Forces HPD high.
	ON	HPD is passed through.
3	OFF (default)	Enables HDCP when using HDMI sources. NOTE: The DVI ELR Lite Extender does not support HDCP with DVI sources.
	ON	Disables HDCP. If a DVI source is being used, set this DIP switch to the ON position.
4	NOT USED	

Specifications

Supported Formats	
Resolutions (max.)	<ul style="list-style-type: none"> • 1920 x 1200 (WUXGA) • 1080p Full HD

Electrical	
Maximum Pixel Clock	<ul style="list-style-type: none"> • 165 MHz
Power Indicator	<ul style="list-style-type: none"> • 1 x LED, blue
Link Indicator	<ul style="list-style-type: none"> • 1 x LED, green

Connectors	
Input (Sender)	<ul style="list-style-type: none"> • 1 x DVI-I, 29-pin, female (digital only)
Output (Receiver)	<ul style="list-style-type: none"> • 1 x DVI-I, 29-pin, female (digital only)
Link (Sender / Receiver)	<ul style="list-style-type: none"> • 1 x RJ-45

Control	
DIP Switches (Sender unit)	<ul style="list-style-type: none"> • 4 x DIP switches for EDID management, HPD, and HDCP

Operational	
Power Input (Sender / Receiver)	<ul style="list-style-type: none"> • 1 x 5V DC
Power Consumption (Sender / Receiver)	<ul style="list-style-type: none"> • 10W per unit (max.)
Operating Temperature	<ul style="list-style-type: none"> • +32 to 113 °F (0 to +45 °C)
Operating Humidity (non-condensing)	<ul style="list-style-type: none"> • 0 to 90% RH

Physical	
Dimensions (W x H x D)	<ul style="list-style-type: none"> • 4.3" x 1" x 4.3" (110mm x 26mm x 86mm)
Unit Weight (each)	<ul style="list-style-type: none"> • 0.36 lbs (0.16 kg)



Stretch it, Switch it, Split it, Control it.
Gefen's got it. ®

20600 Nordhoff St., Chatsworth CA 91311
1-800-545-6900 818-772-9100 fax: 818-772-9120
www.gefen.com support@gefen.com



This product uses UL or CE listed power supplies.