



**THE DISPLAY CHOICE
OF PROFESSIONALS™**

DR-22 LED-Backlit Display

User Manual

www.agneovo.com

TABLE OF CONTENTS

Contents

Safety Information

FCC Declaimers	4
WEEE	5

Precautions

Notice	7
Cautions When Setting Up	7
Cautions When Using	8
Cleaning and Maintenance	8
Symbol Meaning	8
Notice for the LCD Display	9

Chapter 1: Product Description

1.1 Package Contents	11
1.2 Wall Mounting Installation Preparation	12
1.2.1 Wall Mounting	12
1.2.2 Removing the Base Stand	12
1.3 LCD Display Overview	13
1.3.1 Front View and Keypad Buttons	13
1.3.2 Rear View	14

Chapter 2: Making Connections

2.1 Connecting the Power	15
2.2 Connecting Input Source Signals	16
2.2.1 Connecting a Computer	16
Using VGA Cables	16
Using DVI Cables	16
Connecting an Audio Device	17
2.2.2 Connecting a Camera or Video Device	17
Using CVBS Cables	17
Using S-Video Cables	18
Using HDMI Cables	18

Chapter 3: Using the LCD Display

3.1 Turning on the Power	19
3.2 Selecting the Input Source Signal	19
3.3 Adjusting the Volume / Illuminator Function Hot Key	20
3.4 Locking the OSD Menu	20
3.5 Using Picture-in-Picture (PIP)	21
3.5.1 PIP Options	21
3.5.2 PIP Swap	22
3.6 Using ROTATE Function	22
3.7 Using Auto Adjustment Function	23

Chapter 4: On Screen Display Menu

4.1 Using the OSD Menu	24
4.2 OSD Menu Tree	26

TABLE OF CONTENTS

Chapter 5: Adjusting the Settings

5.1 Brightness Setting	29
5.2 Colour Setting	31
5.3 Image Setting (PC Source only)	32
5.4 Image Setting (Video signals)	33
5.5 Aspect Ratio Setting	35
5.6 PIP Setting	37
5.7 OSD Setting	39
5.8 Audio Setting	40
5.9 Other Setting	41
5.10 Auto Brightness	43
5.10.1 EcoSmart Sensor	43
5.11 Input Select	44

Chapter 6: Appendix

6.1 Warning Messages	45
6.2 Troubleshooting	46
6.3 Transporting the LCD Display	48

Chapter 7: Specifications

7.1 Display Specifications	49
7.2 Display Dimensions	50

SAFETY INFORMATION



This FCC Class-B compliant digital device complies with the Interference-Causing Equipment Regulations of Canada.

FCC Disclaimers

This device complies with Section 15 of the FCC listing. The operation procedures must meet the following conditions: (1) the device must not cause any damaging interference; and (2) this device must accept any received interference, including any unpredictable interference that may possibly occur.

Dear users,

This device has passed the Class B digital service regulations and complies with Section 15 of the FCC listing; these are intended to provide reasonable warranty against damaging interference for home use. This device will produce, use, and emit radio frequency energy; therefore, installation or use without following the instructions given may cause damaging interference to radio communication. Nonetheless, it is not possible to state with certainty that interference will occur from specific installations. If this device has caused damaging interference to radio or TV signals (simply turn the device on and off to check if such interference is caused by the device), we recommend that you fix the interference using the following methods:

- Readjust the direction or location of the antenna.
- Increase the distance between this device and the receiver.
- Consult your local dealer or an experienced radio/TV technician.



Warning:

Making changes or modifications to the device without the permission from an authorized dealer may void the warranty of this device.

SAFETY INFORMATION

WEEE

Information for users applicable in European Union countries.

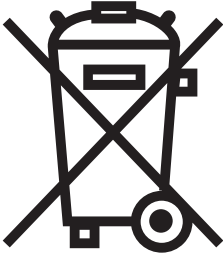

The symbol on the product or its packaging signifies that this product has to be disposed separately from ordinary household wastes at its end of life. Please kindly be aware that this is your responsibility to dispose electronic equipment at recycling centers so as to help conserve natural resources. Each country in the European Union should have its collection centers for electrical and electronic equipment recycling. For information about your recycling drop off area, please contact your local related electrical and electronic equipment waste management authority or the retailer where you bought the product.

Standard	Test item	Standard
EN60601-1-2:2007	RAD & CON	EN55011(EMI)
	Harmonic	EN61000-3-2
	Flicker	EN61000-3-3
	ESD	IEC 61000-4-2: 2008
	RS	IEC 61000-4-3: 2006+A1:2007+A2:2010
	EFT	IEC 61000-4-4: 2012
	Surge	IEC 61000-4-5: 2005
	CS	IEC 61000-4-6: 2008
	PFM	IEC 61000-4-8: 2009
	DIP	IEC 61000-4-11: 2004

Guidance and manufacturer's declaration – electromagnetic emissions

The model DR-22 is intended for use in the electromagnetic environment specified below. The customer or the user of the model DR-22 should assure that it is used in such an environment.

Emissions test	Compliance	Electromagnetic environment – guidance
RF emissions CISPR 11		The model DR-22 uses RF energy only for its internal function. Therefore, its RF emissions are very low and are not likely to cause any interference in nearby electronic equipment.
RF emissions CISPR 11		The model DR-22 is suitable for use in all establishments, including domestic establishments and those directly connected to the public low-voltage power supply network that supplies buildings used for domestic purposes.
Harmonic emissions IEC 61000-3-2		
Voltage fluctuations/ flicker emissions IEC 61000-3-3		

SAFETY INFORMATION

Recommended separation distances between portable and mobile RF communications equipment and the model DR-22

The model DR-22 is intended for use in an electromagnetic environment in which radiated RF disturbances are controlled. The customer or the user of the model DR-22 can help prevent electromagnetic interference by maintaining a minimum distance between portable and mobile RF communications equipment (transmitters) and the model DR-22 as recommended below, according to the maximum output power of the communications equipment.

Rated maximum output power of transmitter W	Separation distance according to frequency of transmitter m		
	150 kHz to 80 MHz $d = 1,2\sqrt{P}$	80 MHz to 800 MHz $d = 1,2\sqrt{P}$	800 MHz to 2,5 GHz $d = 2,3\sqrt{P}$
0,01	0,12	0,12	0,23
0,1	0,38	0,38	0,73
1	1,2	1,2	2,3
10	3,8	3,8	7,3
100	12	12	23

For transmitters rated at a maximum output power not listed above, the recommended separation distance d in metres (m) can be estimated using the equation applicable to the frequency of the transmitter, where P is the maximum output power rating of the transmitter in watts (W) according to the transmitter manufacturer.

NOTE 1 At 80 MHz and 800 MHz, the separation distance for the higher frequency range applies.

NOTE 2 These guidelines may not apply in all situations. Electromagnetic propagation is affected by absorption and reflection from structures, objects and people.

PRECAUTIONS



CAUTION
RISK OF ELECTRIC SHOCK
DO NOT OPEN



Symbols used in this manual

	This icon indicates the existence of a potential hazard that could result in personal injury or damage to the product.
	This icon indicates important operating and servicing information.

Notice

- Read this User Manual carefully before using the LCD display and keep it for future reference.
- The product specifications and other information provided in this User Manual are for reference only. All information is subject to change without notice. Updated content can be downloaded from our web site at <http://www.agneovo.com>.
- To register online, go to <http://www.agneovo.com>.
- To protect your rights as a consumer, do not remove any stickers from the LCD display. Doing so may affect the determination of the warranty period.



ISO 7000-1641 Operating instructions

Cautions When Setting Up



Do not place the LCD display near heat sources, such as a heater, exhaust vent, or in direct sunlight.



Do not cover or block the ventilation holes in the housing.



Place the LCD display on a stable area. Do not place the LCD display where it may be subject to vibration or shock.



Place the LCD display in a well-ventilated area.



Do not place the LCD display outdoors.



Do not place the LCD display in a dusty or humid environment.



Do not spill liquid or insert sharp objects into the LCD display through the ventilation holes. Doing so may cause accidental fire, electric shock or damage the LCD display.

PRECAUTIONS

Cautions When Using



Use only the power cord supplied with the LCD display.



The power outlet should be installed near the LCD display and be easily accessible.



If an extension cord is used with the LCD display, ensure that the total current consumption plugged into the power outlet does not exceed the ampere rating.



Do not allow anything to rest on the power cord. Do not place the LCD display where the power cord may be stepped on.



If the LCD display will not be used for an indefinite period of time, unplug the power cord from the power outlet.



To disconnect the power cord, grasp and pull by the plug head. Do not tug on the cord; doing so may cause fire or electric shock.



Do not unplug or touch the power cord with wet hands.

Cleaning and Maintenance



The LCD display comes with NeoV™ Optical Glass. Use a soft cloth to clean the glass surface and the housing.

The display can be cleaned using a cloth moistened with 95% ethyl alcohol.



Do not rub or tap the surface of the glass with sharp or abrasive items such as a pen or screwdriver. This may result in scratching the surface of the glass.



Do not attempt to service the LCD display yourself, refer to qualified service personnel. Opening or removing the covers may expose you to dangerous voltage or other risks.

Symbol Meaning

⎓ IEC 60417-5031 Direct current

⏻ IEC 60417-5009 STAND-BY



Warning:



Unplug the power cord from the power outlet and refer to qualified service personnel under the following conditions:

- ◆ When the power cord is damaged.
- ◆ If the LCD display has been dropped or the housing has been damaged.
- ◆ If the LCD display emits smoke or a distinct odor.



Warning:



Ceiling mount or mount on any other horizontal surface overhead are not advisable.

Installation in contravention of the instructions may result in undesirable consequences, particularly hurting people and damaging property. Users who have already mounted the display on the ceiling or any other horizontal surface overhead are strongly advised to contact AG Neovo for consultations and solutions to help ensure a most pleasurable and fulfilling display experience.

PRECAUTIONS

Notice for the LCD Display

In order to maintain the stable luminous performance, it is recommended to use low brightness setting.

Due to the lifespan of the lamp, it is normal that the brightness quality of the LCD display may decrease with time.

When static images are displayed for long periods of time, the image may cause an imprint on the LCD display. This is called image retention or burn-in.

To prevent image retention, do any of the following:

- Set the LCD display to turn off after a few minutes of being idle.
- Use a screen saver that has moving graphics or a blank white image.
- Switch desktop backgrounds regularly.
- Adjust the LCD display to low brightness settings.
- Turn off the LCD display when the system is not in use.

Things to do when the LCD display shows image retention:

- Turn off the LCD display for extended periods of time. It can be several hours or several days.
- Use a screen saver and run it for extended periods of time.
- Use a black and white image and run it for extended periods of time.

When the LCD display is moved from one room to another or there is a sudden change from low to high ambient temperature, dew condensation may form on or inside the glass surface. When this happens, do not turn on the LCD display until the dew disappears.

Due to humid weather conditions, it is normal for mist to form inside the glass surface of the LCD display. The mist will disappear after a few days or as soon as the weather stabilizes.

There are millions of micro transistors inside the LCD display. It is normal for a few transistors to be damaged and to produce spots. This is acceptable and is not considered a failure.

The intended use of the DR-22 is to serve as a LCD monitor for integration with the hospital system. It is designed for general purpose for hospital environment. For displaying and viewing of images for reference. The use of this device does not require any direct contact with patients.

Accessory equipment connected to the analog and digital interfaces must be in compliance with the respective nationally harmonized IEC standards (i.e. IEC 60950 for data processing equipment, IEC 60065 for video equipment, IEC 61010-1 for laboratory equipment, and IEC 60601-1 for medical equipment.) Furthermore all configurations shall comply with the system standard IEC 60601-1-1. Everybody who connects additional equipment to the signal input part or signal output part configures a medical system, and is therefore, responsible that the system complies with the requirements of the system standard IEC 60601-1-1. The unit is for exclusive interconnection with IEC 60601-1 certified equipment in the patient environment and IEC 60XXX certified equipment outside of the patient environment. If in doubt, consult the technical services department or your local representative.

Grounding reliability can only be achieved when the equipment is connected to an equivalent receptacle marked "Hospital Only" or "Hospital Grade".

PRECAUTIONS

Notice for the LCD Display

Use a power cord that matches the voltage of the power outlet, which has been approved and complies with the safety standard of your particular country.

WARNING – Do not modify this equipment without authorization of the manufacturer.

WARNING – To avoid risk of electric shock, this equipment must only be connected to a supply mains with protective earth.

CAUTION: This adapter Manufacturer/model is a forming part of the medical device.

- ◆ Adapter manufacturer/model: ADAPTER TECH / ATM065-P240.
- ◆ Input/output: 100-240V~50-60Hz 1.6-0.7A / 24V(==) 2.71A.

WARNING: Use suitable mounting apparatus to avoid risk of injury.

CAUTION: Make sure the user not to contact SIP/SOPs and the patient at the same time.

CHAPTER 1: PRODUCT DESCRIPTION

1.1 Package Contents

When unpacking, check if the following items are included in the package. If any of them is missing or damaged, contact your dealer.

LCD Display

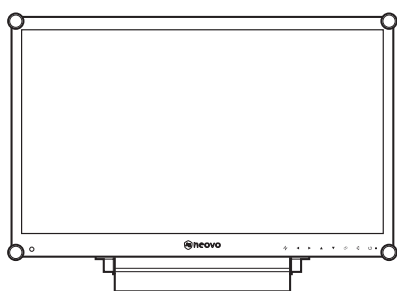

User Manual

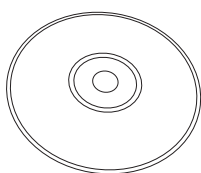

Power adapter

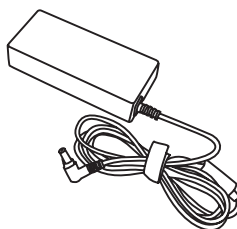

Power cord

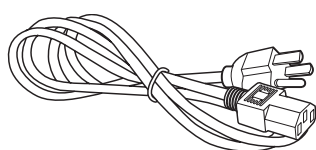

VGA cable

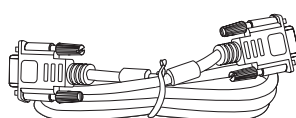

Audio cable

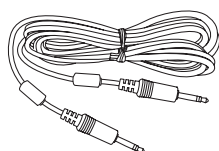

Warranty card

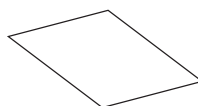

Note:

- ◆ The pictures are for reference only. Actual items may vary upon shipment.

PRODUCT DESCRIPTION

1.2 Wall Mounting Installation Preparation

1.2.1 Wall Mounting

1 Remove the base stand.

See procedures below.

2 Wall mount the LCD display.

Screw the mounting bracket to the VESA holes at the rear of the LCD display.

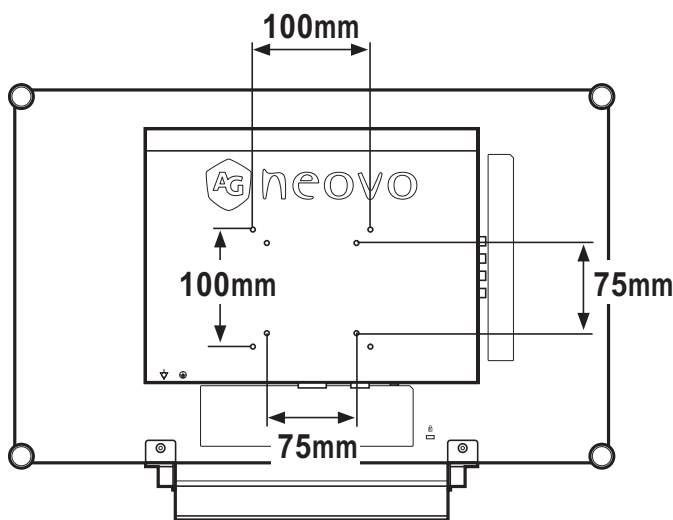

1.2.2 Removing the Base Stand

- 1 Lay the LCD display face down on a flat even surface.
- 2 Remove the four screws securing the base stand from the LCD display.
- 3 Detach the base stand.

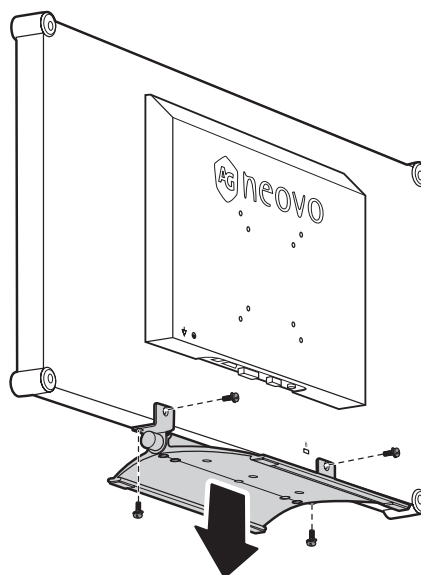

Note:

To protect the glass panel, place a towel or soft cloth before laying the LCD display down.



Warning:



Ceiling mount or mount on any other horizontal surface overhead are not advisable.

Installation in contravention of the instructions may result in undesirable consequences, particularly hurting people and damaging property. Users who have already mounted the display on the ceiling or any other horizontal surface overhead are strongly advised to contact AG Neovo for consultations and solutions to help ensure a most pleasurable and fulfilling display experience.

Note:

Take measures to prevent the LCD display from falling down and lessen possible injury and damage to the display in case of earthquakes or other disasters.

- ◆ Use only the 75 x 75 mm and 100 x 100 mm wall mount kit recommended by AG Neovo.
- ◆ Secure the LCD display on a solid wall strong enough to bear its weight.

PRODUCT DESCRIPTION

1.3 LCD Display Overview

1.3.1 Front View and Keypad Buttons

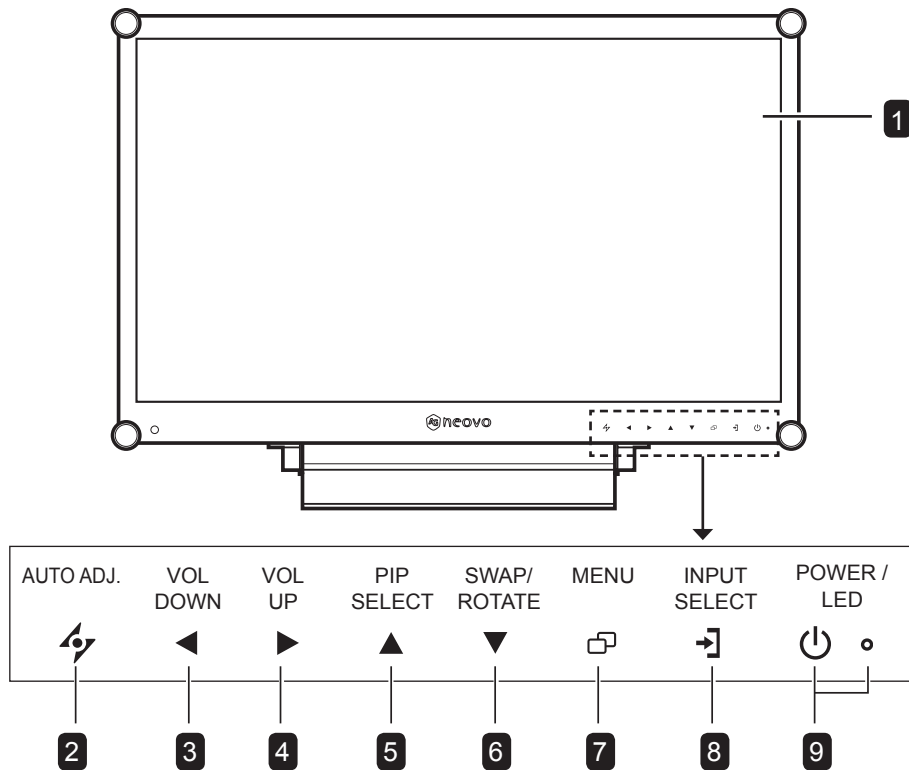

1 Display screen

The LCD display screen is protected by NeoV™ Optical Glass.

2 AUTO

- For VGA input signal source, press to perform auto adjustment.
- During OSD menu selection, press to close the OSD menu or exit a submenu.

3 LEFT

- Press to display the volume screen. Then press again to decrease the volume.
- During OSD menu selection, press to adjust the settings.

4 RIGHT

- Press to increase the volume.
- During OSD menu selection, press to select an option and adjust the settings.

5 UP

- Press repeatedly to select PIP option.
- During OSD menu selection, press to move up a menu or submenu.

6 DOWN

- When PIP is on, press to SWAP the PIP main and sub picture.
- When PIP is off, press to rotate the image 180°.
- During OSD menu selection, press to move up a menu or submenu.

7 MENU

- Press to display the OSD menu.
- Press again to hide the OSD menu.

8 SOURCE

- Press to select the input signal source.

9 POWER / LED indicator

- Press to turn the power on or off.
Green - Power on
Amber - Standby mode
Off - Power off

Illuminator Function Hot Key

Press and hold ◀ and ▶ for 3 seconds to turn the screen completely white to enable you to see the light box for the x-ray film. To change the screen back to normal display mode, press and hold ◀ and ▶ for 3 seconds again.

PRODUCT DESCRIPTION

1.3.2 Rear View

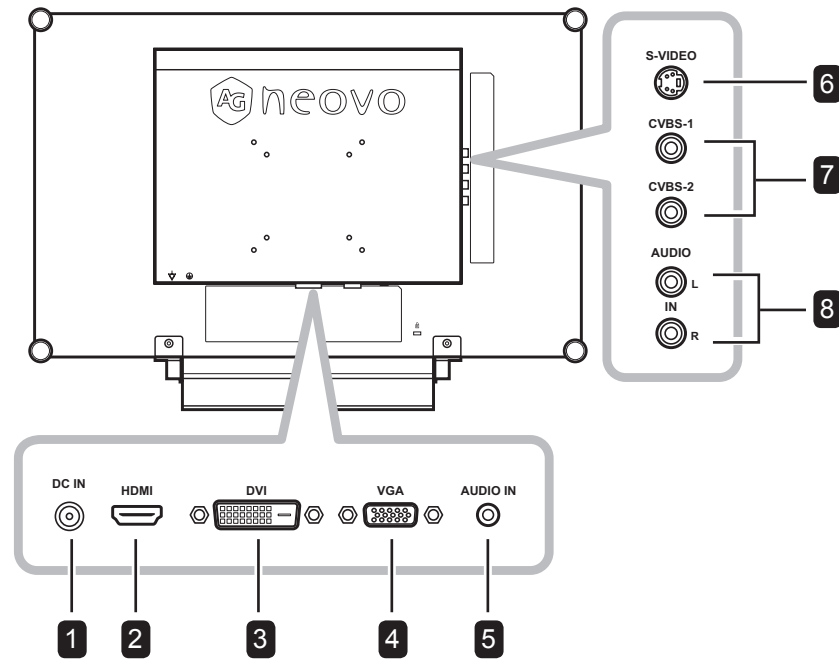

1 DC power input

Use to connect the power cord.

2 HDMI connector

Use to connect an input device using HDMI cable for digital input signal.

3 DVI connector

Use to connect a PC using DVI cable for digital input signal.

4 VGA connector

Use to connect a PC using a VGA cable for analogue input signal.

5 Audio port

Use to connect an audio cable for the PC's audio input.

6 S-Video connector

Use to connect AV cables for the S-Video signal.

7 COMPOSITE Video input connectors

Use to connect composite cables for CVBS input signal.

8 COMPOSITE Audio input connectors

Use to connect RCA cables for CVBS / S-Video audio signal.

CHAPTER 2: MAKING CONNECTIONS

2.1 Connecting the Power

- 1 Connect the power cord to the power adapter.
- 2 Connect the power adapter to the DC power input at the rear of the LCD display.
- 3 Connect the power cord plug to a power outlet or a power supply.

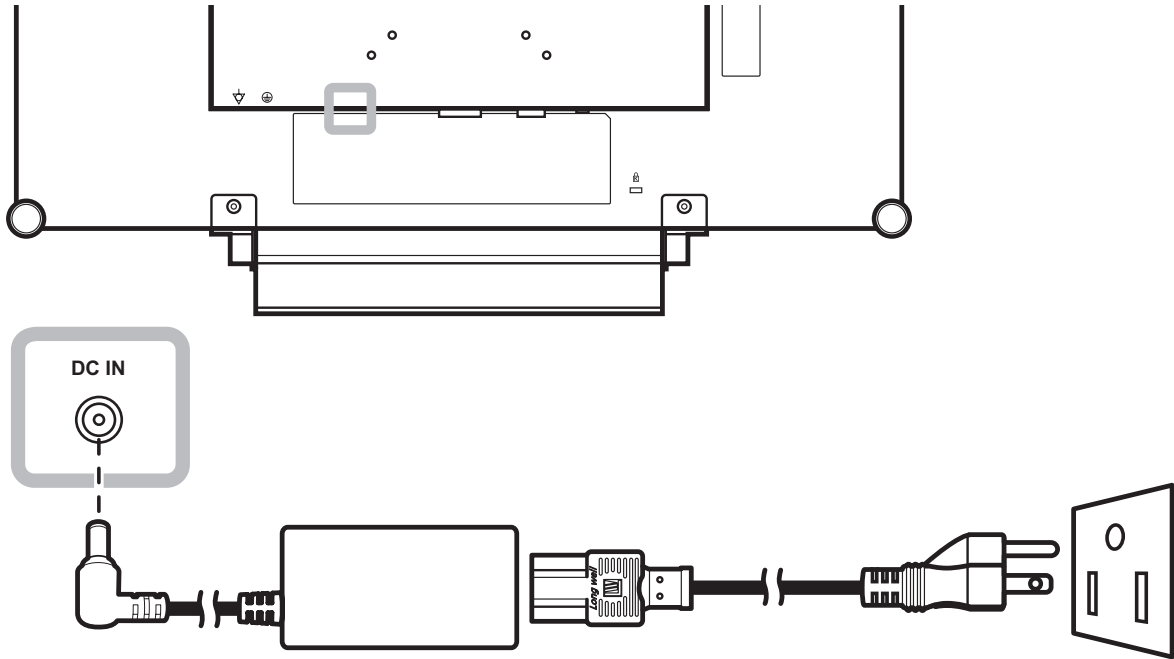

Caution:

- ◆ Make sure that the LCD display is not connected to the power outlet before making any connections. Connecting cables while the power is ON may cause electric shock or personal injury.



Caution:

- ◆ When unplugging the power cord, hold the power cord by the plug head. Never pull by the cord.

MAKING CONNECTIONS

2.2 Connecting Input Source Signals

2.2.1 Connecting a Computer

Using VGA Cables

Connect one end of a D-sub cable to the VGA connector of the LCD display and the other end to the D-sub connector of the computer.

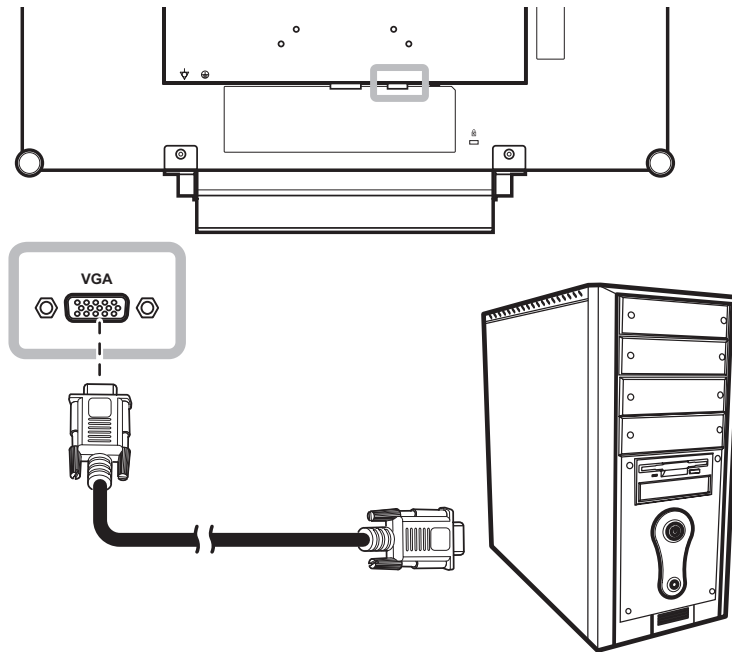

Using DVI Cables

Connect one end of a DVI cable to the DVI connector of the LCD display and the other end to the DVI connector of the computer.

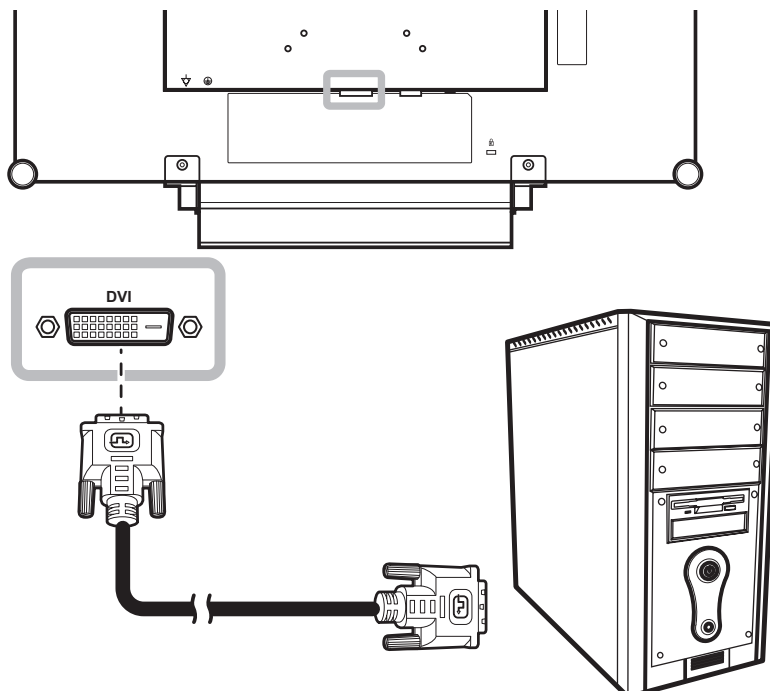

MAKING CONNECTIONS

Connecting an Audio Device

Connect one end of an audio cable to the audio port at the rear of the LCD display and the other end to the audio out port of the computer.

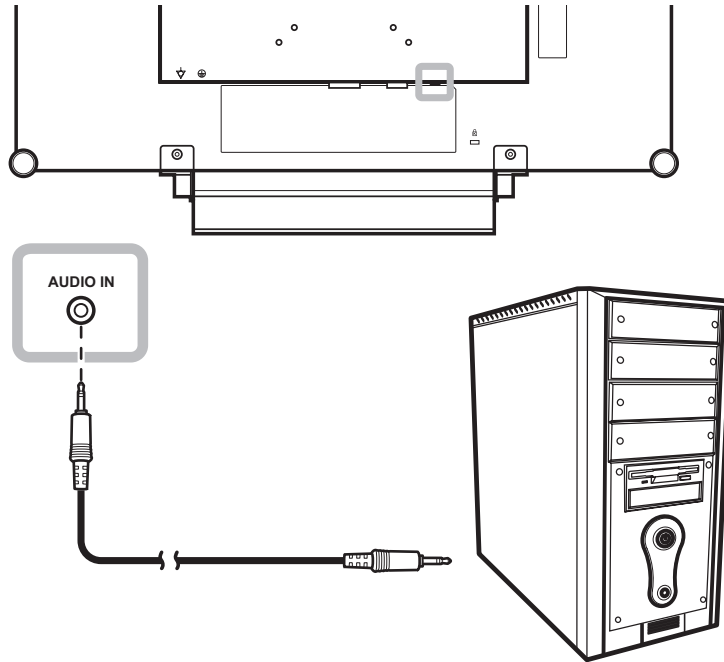

2.2.2 Connecting a Camera or Video Device

Using CVBS Cables

Connect one end of a CVBS cable to the COMPOSITE connectors of the LCD display and the other end to the COMPOSITE connectors of your device.

For audio input, connect an RCA cable to the audio in connector of the LCD display and the audio out connector of your device.

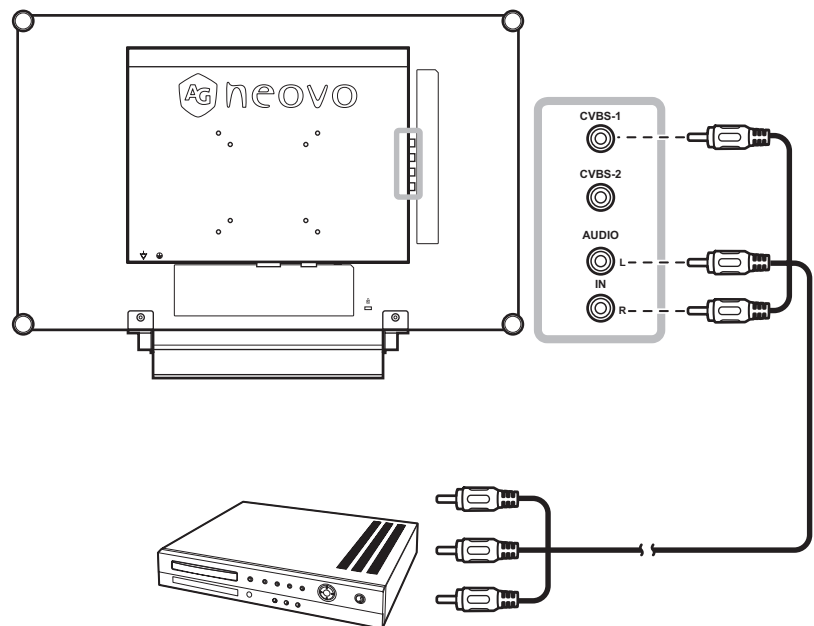

MAKING CONNECTIONS

Using S-Video Cables

Connect one end of an S-Video cable to the S-VIDEO connector of the LCD display and the other end to the S-VIDEO connector of your device.

For audio input, connect an RCA cable to the audio in connector of the LCD display and the audio out connector of your device.

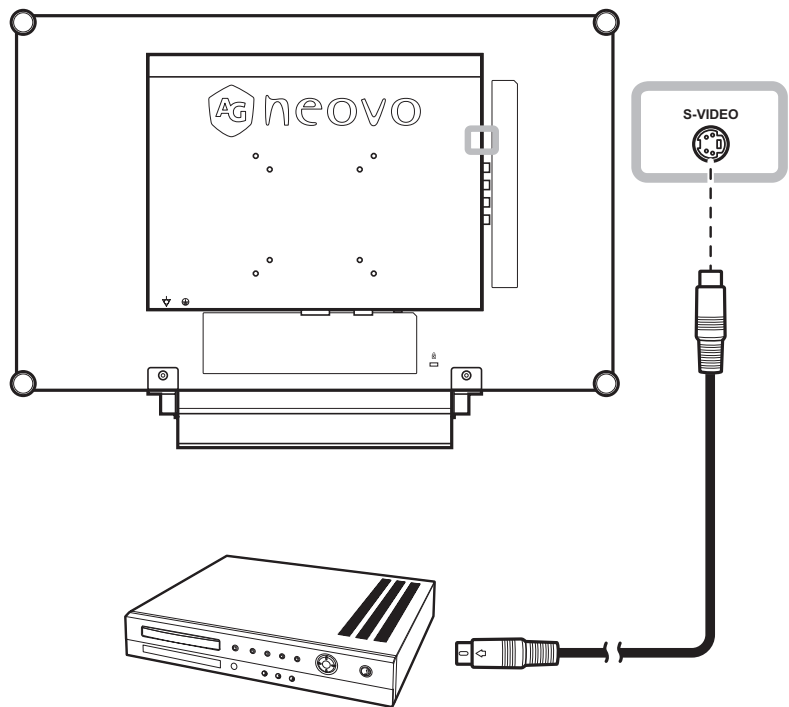

Using HDMI Cables

Connect one end of an HDMI cable to the HDMI connector of the LCD display and the other end to the HDMI connector of your device.

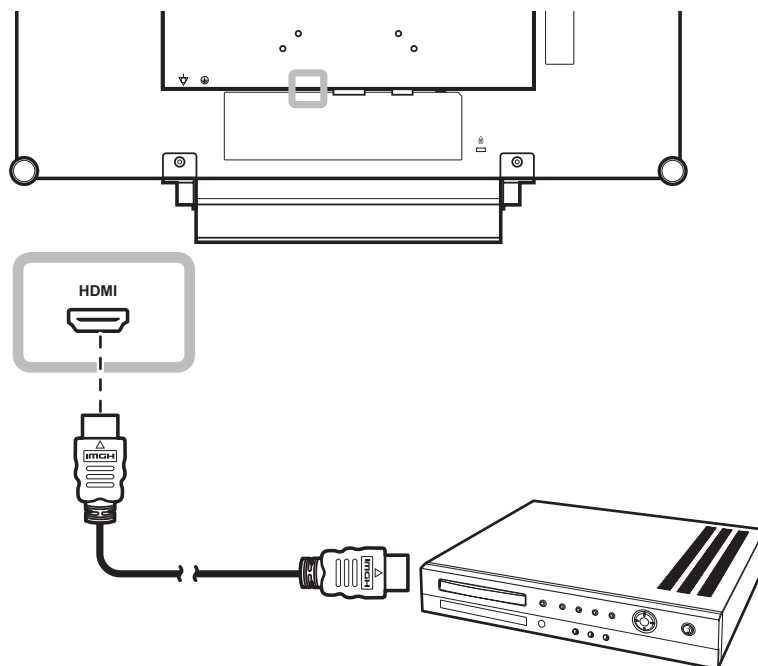

CHAPTER 3: USING THE LCD DISPLAY

3.1 Turning on the Power

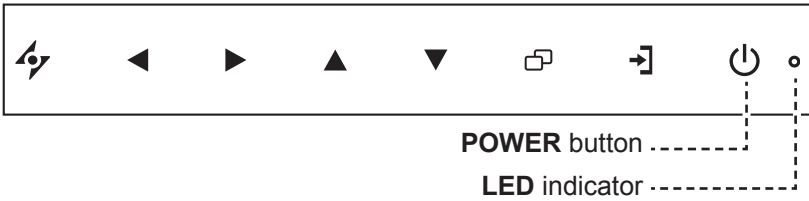

1 Plug the power cord to a power outlet or power supply.

2 Touch the **POWER** button to turn the LCD display on.

The LED indicator turns GREEN.

When the LCD display is turned on, touch the POWER button to turn off the LCD display.

The LED indicator turns off.

3.2 Selecting the Input Source Signal



Touch the  button to select the input source signal.

Note:

- ◆ The LCD display still consumes power as long as the power cord is connected to the power outlet. Disconnect the power cord to completely cut off power.

Notes:

- ◆ After selecting an input source signal, the input source signal message appears on the screen briefly.

For example, CVBS1 is selected the following message is displayed.



- ◆ If the selected input source signal is not connected to the LCD display or is turned off, the no signal message is displayed on the screen.



- ◆ If the resolution or the graphics card of the connected computer is set too high, the input out of range message is displayed.



USING THE LCD DISPLAY

3.3 Adjusting the Volume / Illuminator Function Hot Key

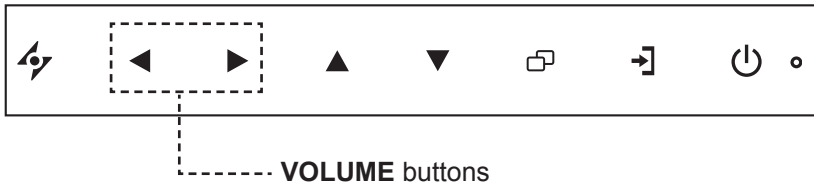

Adjusting the Volume

1 Touch either the ◀ or ▶ buttons to call out the volume bar.

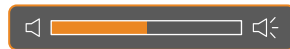

2 Touch the ▶ button to increase volume or the ◀ button to decrease volume.
To mute the audio, set the volume to 0.

Illuminator Function Hot Key

Press and hold ◀ and ▶ for 3 seconds to turn the screen completely white to enable you to see the light box for the x-ray film. To change the screen back to normal display mode, press and hold ◀ and ▶ for 3 seconds again.

3.4 Locking the OSD Menu

Lock the OSD menu to protect the LCD display from unauthorised users or from accidentally pressing the keypad.

To lock the OSD, press and hold the keypad buttons listed below for at least 5 seconds or until the  message appears.

When the OSD is locked, all keypad buttons are inactivated.

Type of OSD Lock	Lock Operation	Unlock Operation
Lock all buttons	Touch and hold the ▶, ▲, and the ▼ buttons for 5 seconds.	Touch and hold the ▶, ▲, and the ▼ buttons for 5 seconds or until the OSD menu appears.
Lock all buttons except the POWER button.	Touch and hold the ◀, ▲, and the ▼ buttons for 5 seconds.	Touch and hold the ◀, ▲, and the ▼ buttons for 5 seconds or until the OSD menu appears.

USING THE LCD DISPLAY

3.5 Using Picture-in-Picture (PIP)

The Picture-in-Picture (PIP) feature allows viewing of more than one input source signal on the LCD display.

3.5.1 PIP Options

Touch the ▲ button repeatedly to enable and scroll among the PIP options. Options are as follows:

- PIP On: The sub source signal is displayed within the main source signal.
- PAP (Picture-and-Picture): The main source and the sub source signals are displayed side by side with equal display size.
- PIP Off: PIP function is disabled, only the main source signal is displayed.



Note:

- ◆ The main source and sub source signals can be set in PIP Setting, see page 33.
- ◆ Some input source signal combinations do not support PIP. See PIP Compatibility table on page 34.

USING THE LCD DISPLAY

3.5.2 PIP Swap

The main and the sub source signals set in PIP Setting can be easily swapped using the keypad.



Touch the ▼ button to swap the main source and the sub source signals. See illustration below.



3.6 Using ROTATE Function

The ROTATE function allows you to rotate the screen image at 180°.

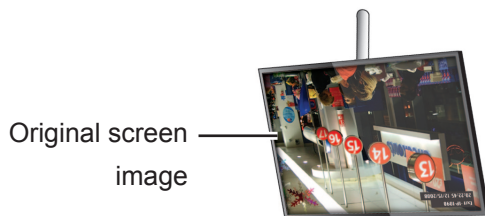

Touch the ▼ button to rotate the picture 180°. See illustration below.



After executing ROTATE, touch the ▼ button again to rotate the picture back to its normal state.

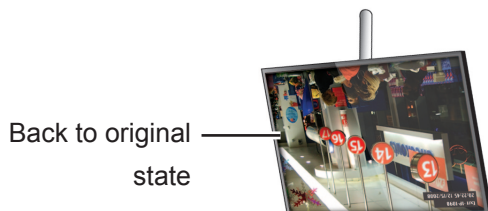

Note:

- ◆ PIP Swap can only be executed if PIP is enabled, see page 33.

Note:

- ◆ ROTATE function can only be executed if PIP is off, see page 33.

USING THE LCD DISPLAY

3.7 Using Auto Adjustment Function

Auto Adjustment function automatically tunes the LCD display to its optimal setting, including horizontal position, vertical position, clock, and phase.

Touch the  button to perform auto adjustment.

The message auto adjusting is displayed on the screen.



During auto adjustment, the screen will slightly shake for a few seconds.



When the message disappears, auto adjustment is completed.

Note:

- ◆ Auto Adjustment function is available only during VGA input signals.
- ◆ It is recommended to use the auto adjustment function when using the LCD display for the first time or after a resolution or frequency change.

CHAPTER 4: ON SCREEN DISPLAY MENU

4.1 Using the OSD Menu

		Operation
1	<p>Display the main menu screen.</p> 	<p>Touch .</p>
2	<p>Select the menu.</p> 	<ol style="list-style-type: none">1 Touch the ▲ or ▼ buttons.2 Touch the ► button to enter the submenu.

ON SCREEN DISPLAY MENU

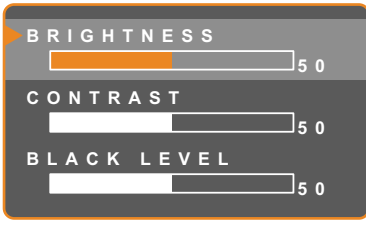
		Operation
<p>3 Select the submenu item.</p>  <p>The highlighted item with an orange arrow indicates the active submenu.</p>		Touch the ▲ or ▼ buttons.
<p>4 Adjust the settings.</p>		Touch the ◀ or ▶ buttons.
<p>5 Exit the submenu.</p>		Touch ⚡ or ◻ to return to the previous menu.
<p>6 Close the OSD window.</p>		Touch ⚡ or ◻ again.

When settings are modified, all changes are saved when the user does the following:

- Proceeds to the another menu.
- Exits the OSD menu.
- Waits for the OSD menu to disappear.

Note: Availability of some menu items depend on the input source signal. If the menu is not available, it is disabled and grayed out.

ON SCREEN DISPLAY MENU

4.2 OSD Menu Tree

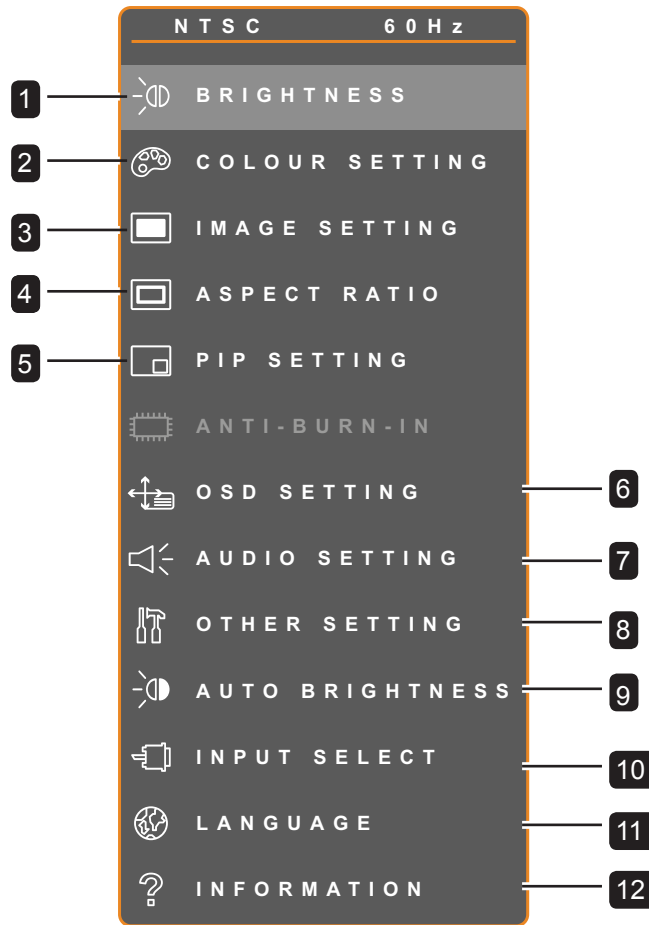

Main Menu	Submenu	Remarks
1. Brightness	<ul style="list-style-type: none"> • Brightness • Contrast • Black Level 	See page 29.
2. Colour Setting	<ul style="list-style-type: none"> • Colour Temperature 	See page 31.
3. Image Setting	During PC input signal: <ul style="list-style-type: none"> • Sharpness • Phase • Clock • H. Position • V. Position 	See page 32.

ON SCREEN DISPLAY MENU

Main Menu	Submenu	Remarks
Image Setting	During Video input signal: <ul style="list-style-type: none"> • Sharpness • Saturation • Tint • 3D Comb Filter • Noise Reduction • Aspect Ratio • H. Zoom • V. Zoom • H. Position • V. Position 	See page 33.
4. Aspect Ratio	<ul style="list-style-type: none"> • Aspect Ratio • H. Zoom • V. Zoom 	See page 35.
5. PIP Setting	<ul style="list-style-type: none"> • PIP • Main Source • Sub Source • Sub Picture Size • Sub Pic. Pos. • Swap 	See page 37.
6. OSD Setting	<ul style="list-style-type: none"> • Transparency • H. Position • V. Position • OSD Timer 	See page 39.
7. Audio Setting	<ul style="list-style-type: none"> • Volume • Audio 	See page 40.
8. Other Setting	<ul style="list-style-type: none"> • Power Saving • Mode • DDC/CI • DCR • Recall 	See page 41.
9. Auto Brightness	<ul style="list-style-type: none"> • Enable • Mode • Level 	See page 43.





ON SCREEN DISPLAY MENU



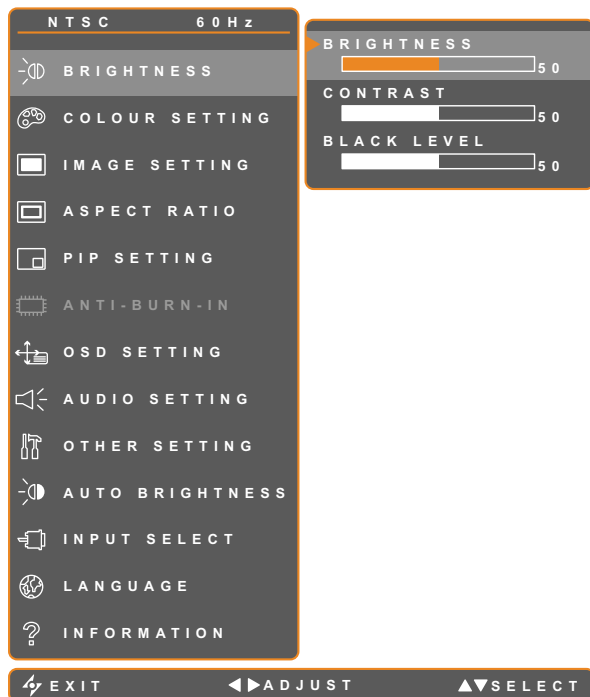



Main Menu	Submenu	Remarks
10. Input Select	<ul style="list-style-type: none"> • VGA • DVI • HDMI • CVBS1 • CVBS2 • S-Video 	See page 44.
11. Language	Select the OSD language: EN / FR / DE / ES / IT / PY / RO / PL / CS / NL / 簡中 / 繁中	
12. Information	Displays settings information such as Input, Resolution, Horizontal and Vertical Frequency, Time mode, and Firmware version.	

CHAPTER 5: ADJUSTING THE LCD DISPLAY

5.1 Brightness Setting











1. Touch  to call out the OSD window.
2. Select BRIGHTNESS menu, then touch the  button.
3. Touch the  or  buttons to select an option.

Item	Function	Operation	Range
Brightness	Adjusts the luminance of the screen image. Note: Backlight setting is disabled if Auto Brightness is On.	Touch the  or  buttons to adjust the value.	0 to 100
Contrast	Adjusts the difference between the black level and the white level.	Touch the  or  buttons to adjust the value.	0 to 100
Black Level	Adjusts the black level of the screen image. Low brightness setting makes black colour darker.	Touch the  or  buttons to adjust the value.	0 to 100

See comparison illustrations on page 28.





ADJUSTING THE LCD DISPLAY



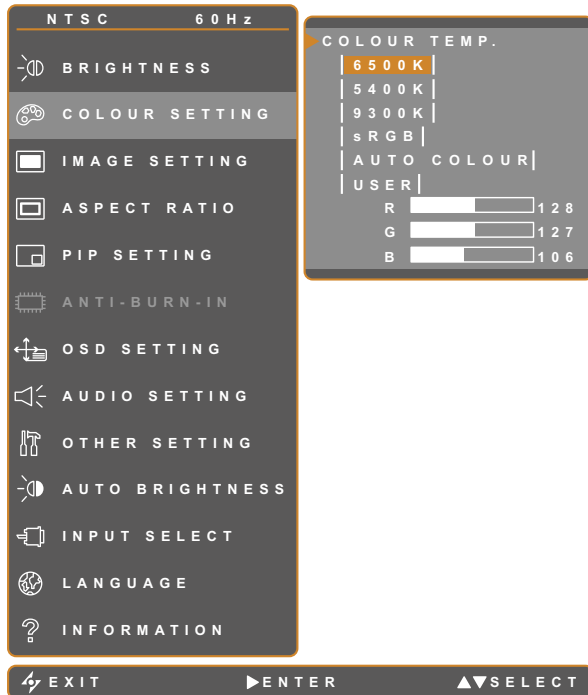





	Original Setting	High Setting	Low Setting
Brightness			
Contrast			
Black Level			

ADJUSTING THE LCD DISPLAY

5.2 Colour Setting



1. Touch  to call out the OSD window.
2. Select COLOUR SETTING menu, then touch the  button.
3. Touch the  or  buttons to select an option.





Item	Function	Operation	Value
Colour Temperature	Provides several colour adjustment settings.	Touch the  or  buttons to select the setting.	6500K, 5400K, 9300K, sRGB, USER
	<p>Colour temperature can be set to:</p> <ul style="list-style-type: none"> • 6500K - This is the default colour temperature commonly used for normal lighting conditions. • 5400K - Applies a reddish tint for warmer colours. • 9300K - Applies a bluish tint for cooler colours. • sRGB - This is the Red, Green, Blue (RGB) colour standard which is used for colour management in most industries. This setting displays accurate colours and suitable for viewing images on the Internet. • AUTO COLOUR - Operates the white balance and automatically adjusts the colour settings. Available only during VGA input source signal <ol style="list-style-type: none"> 1 Select AUTO COLOUR. 2 Touch the  button to activate auto colour. • USER - This allows users to set the colour temperature by adjusting the R, G, B settings according to one's preference. <ol style="list-style-type: none"> 1 Select USER, then touch the  button 2 Touch the  or  buttons to select among R, G, B option. 3 Touch the  or  buttons to adjust the values between 0 ~ 255. <p>Note: Activate Recall to return the colour to its default setting.</p>		



ADJUSTING THE LCD DISPLAY

5.3 Image Setting (PC Source only)

Note: Some submenu items are not available in DVI input source signal.



1. Touch  to call out the OSD window.
2. Select IMAGE SETTING menu, then touch the  button.
3. Touch the  or  buttons to select an option.

Item	Function	Operation	Range
Sharpness	Adjusts the clarity and focus of the screen image.	Touch the  or  buttons to adjust the value.	0 to 100
Phase	Adjusts the phase timing to synchronise with the video signal. Note: Phase is only available when receiving VGA input signal.		
Clock	Adjusts the frequency timing to synchronise with the video signal. Note: Clock is only available when receiving VGA input signal.		
H. Position (Horizontal Position)	Moves the screen image to the left or right.		
V. Position (Vertical Position)	Moves the screen image up or down.		

ADJUSTING THE LCD DISPLAY

5.4 Image Setting (Video signals)

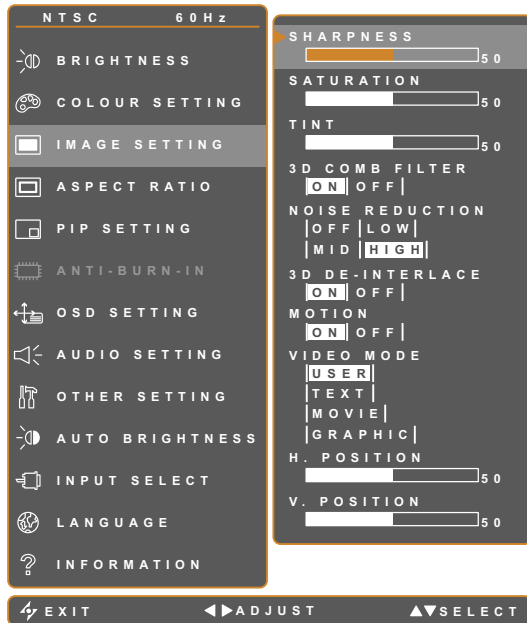

1. Touch to call out the OSD window.
2. Select IMAGE SETTING menu, then touch the button.
3. Touch the or buttons to select an option.

Item	Function	Operation	Range / Value
Sharpness	Adjusts the clarity and focus of the screen image.		
Saturation	Adjusts the colour saturation.	Touch the or buttons to adjust the value.	0 to 100
Tint	Adjusts the colour tint. Note: Available only during NTSC system under S-Video or CVBS signals.		
3D Comb Filter	Enables the 3D Comb Filter feature, which eliminates cross-colouring or rainbow swirl on pictures. Note: Available only during CVBS signal.	Touch the or buttons to select the value.	On Off





3D Comb Filter Off



3D Comb Filter On

ADJUSTING THE LCD DISPLAY





Item	Function	Operation	Range / Value
Noise Reduction	Adjusts the noise reduction to help remove noise from images. This helps produce clearer and crisper images.	Touch the ◀ or ▶ buttons to select the value.	Off Low High
 <p>Noise Reduction Off</p>		 <p>Noise Reduction On</p>	
Aspect Ratio	Adjusts the aspect ratio of the screen image.	Touch the ◀ or ▶ buttons to select the value.	Overscan Underscan Native
	Aspect ratio can be set to: <ul style="list-style-type: none"> • OVERSCAN: The aspect ratio decreases by 5%. • UNDERSCAN: The aspect ratio increases by 5%. • NATIVE: The aspect ratio returns to its default size. 		
H. Zoom (Horizontal Zoom)	Adjusts the horizontal zoom.	Touch the ◀ or ▶ buttons to adjust the value.	0 to 100
V. Zoom (Vertical Zoom)	Adjusts the vertical zoom.		
H. Position (Horizontal Position)	Moves the screen image to the left or right.		
V. Position (Vertical Position)	Moves the screen image up or down.		



ADJUSTING THE LCD DISPLAY

5.5 Aspect Ratio Setting

Note: Overscan is available only in VGA and HDMI input source signals.

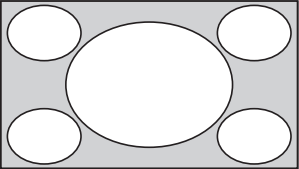
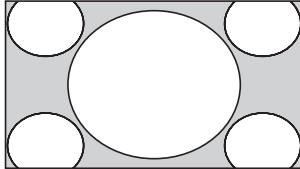
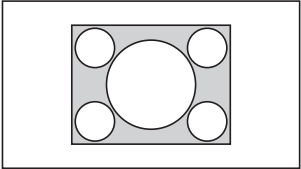
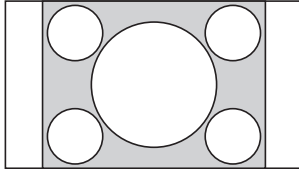

1. Touch  to call out the OSD window.
2. Select ASPECT RATIO menu, then touch the  button.
3. Touch the  or  buttons to select an option.

Item	Function	Operation	Range / Value	
Aspect Ratio	Adjusts the aspect ratio of the screen image. Note: Overscan is only available when receiving video (CVBS/S-Video) and HDMI input source signals.	Touch the  or  buttons to select the value.	Underscan Overscan Normal Native	
	Aspect ratio can be set to: <ul style="list-style-type: none"> • Underscan: The picture is displayed in full screen. • Overscan: The picture is displayed in full screen while retaining the original aspect ratio. This results in a zoomed image and some part of the picture may appear cut-off. • Normal: The picture is displayed based on the current monitor resolution. • Native: The picture is displayed based on its actual resolution. 			
				
	Underscan	Overscan	Native	Normal





ADJUSTING THE LCD DISPLAY







Item	Function	Operation	Range / Value
H. Zoom (Horizontal Zoom)	Adjusts the horizontal zoom.	Touch the ◀ or ▶ buttons to adjust the value.	0 to 100
V. Zoom (Vertical Zoom)	Adjusts the vertical zoom.		

ADJUSTING THE LCD DISPLAY

5.6 PIP Setting



1. Touch  to call out the OSD window.
2. Select PIP SETTING menu, then touch the  button.
3. Touch the  or  buttons to select an option.

Item	Function	Operation	Range / Value
PIP	Allows you to select the PIP setting or disable PIP.	Touch the  or  buttons to select the value.	Off PIP PAP
	PIP can be set to: <ul style="list-style-type: none"> • Off - Disables PIP. • PIP - The sub source image is within the main source image. • PAP - The main source and sub source images are displayed side by side. 		
Main Source	Allows you to select the main source signal.	Touch the  or  buttons to select the value.	VGA / DVI / HDMI / CVBS1 / CVBS2 / S-VIDEO
Sub Source	Allows you to select the sub source signal.	Touch the  or  buttons to select the value.	VGA / DVI / HDMI / CVBS1 / CVBS2 / S-VIDEO

ADJUSTING THE LCD DISPLAY

Note: Any input signal may be set as the main or the sub source signal. However, some input signals are not supported to be paired together as the main and the sub source signals.

Refer to the following table for compatibility options.

Table 5.1 PIP Compatibility Table





Main Sub	VGA	DVI	HDMI	CVBS1	CVBS2	S-VIDEO
VGA	X	X	X	O	O	O
DVI	X	X	X	O	O	O
CVBS1	O	O	O	X	X	X
CVBS2	O	O	O	X	X	X
S-VIDEO	O	O	O	X	X	X



Item	Function	Operation	Range / Value
Sub Pic. Size (Sub Picture Size)	<p>Allows you to select the size of the sub source image. Available only in PIP mode.</p> <ul style="list-style-type: none"> • 1 - Small image size. • 2 - Medium image size. • 3 - Large image size. 	Touch the ◀ or ▶ buttons to select the value.	1 2 3
Sub Pic. Pos. (Sub Picture Position)	<p>Allows you to select the position of the sub source image. Available only in PIP mode.</p> <ul style="list-style-type: none"> • L+U - Sets the image on the upper left corner of the screen. • R+U - Sets the image on the upper right corner of the screen. • L+D - Sets the image on the lower left corner of the screen. • R+D - Sets the image on the lower right corner of the screen. 	Touch the ◀ or ▶ buttons to adjust the value.	L+U R+U L+D R+D
Swap	Swaps the main source and sub source signals.	Touch the ▶ button to swap the image sources.	

ADJUSTING THE LCD DISPLAY

5.7 OSD Setting







1. Touch  to call out the OSD window.
2. Select OSD SETTING menu, then touch the  button.
3. Touch the  or  buttons to select an option.



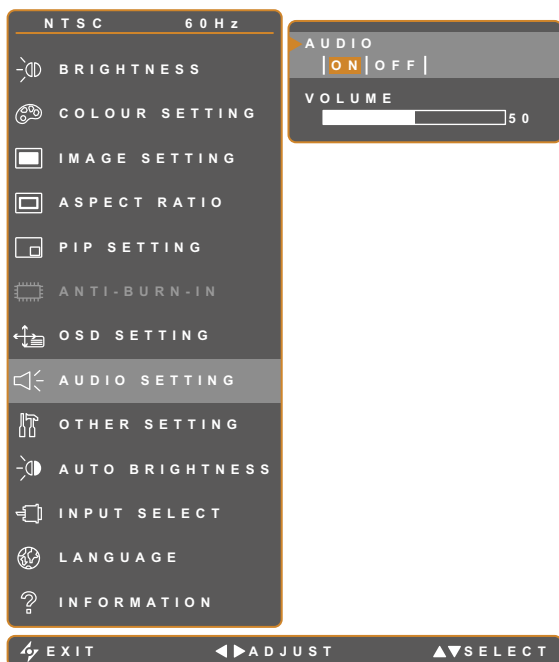

Item	Function	Operation	Range
Transparency	Adjusts the transparency level of the OSD screen.		
H. Position (Horizontal Position)	Moves the OSD window to the left or right of the screen.	Touch the  or  buttons to adjust the value.	0 to 100
V. Position (Vertical Position)	Moves the OSD window up or down the screen.		
OSD Timer	Sets the length of time (in seconds) the OSD screen is displayed. When the time elapses, the OSD screen is automatically inactivated.		5 to 100

ADJUSTING THE LCD DISPLAY

5.8 Audio Setting







1. Touch  to call out the OSD window.
2. Select AUDIO SETTING menu, then touch the  button.
3. Touch the  or  buttons to select an option.



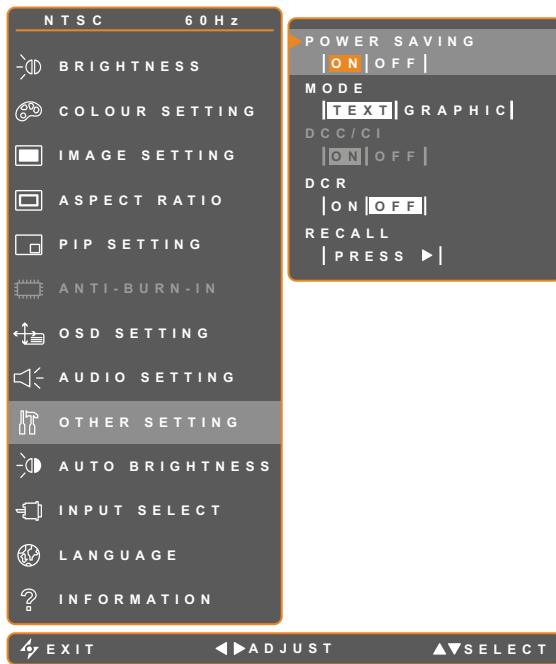

Item	Function	Operation	Range / Value
Volume	Adjusts the volume level of the built-in speaker. Note: If volume is adjusted but Audio is set to "Off", no sound comes out from the speaker.	Touch the  or  buttons to adjust the value.	0 to 100
Audio	Turns the audio speaker ON or OFF.	Touch the  or  buttons to select the value.	On Off

ADJUSTING THE LCD DISPLAY

5.9 Other Setting



1. Touch  to call out the OSD window.
2. Select OTHER SETTING menu, then touch the  button.
3. Touch the  or  buttons to select an option.

Item	Function	Operation	Range / Value
Power Saving	<p>Enables or disables power saving mode.</p> <p>When the LCD display turns into power saving mode, the screen turns black and the LED indicator lights AMBER.</p> <p>Note: The amount of time for the display to enter power saving varies depending on the Source Detect setting. If Source Detect is Auto, the display checks all input source signals before entering power saving mode if no signal is detected; this takes up more time. If Source Detect is Manual, the display enters power saving mode right away.</p>	Touch the  or  buttons to select the value.	On Off
Mode	<p>Sets the current mode for better image display.</p> <p>Available only during computer input signal, when the resolution is either of the following: 640 x 350, 640 x 400, 720 x 350, or 720 x 400.</p> <p>For optimal performance, select:</p> <ul style="list-style-type: none"> • Text - This mode is suitable for viewing text documents when the resolution is 720 x 400 or 720 x 350. • Graphic - Graphics mode is suitable for viewing images when the resolution is 640 x 350 or 640 x 400. 	Touch the  or  buttons to select the value.	Text Graphic

ADJUSTING THE LCD DISPLAY

Item	Function	Operation	Range / Value
DDC/CI	Activates the DDC/CI protocol to allow users to configure the monitor by a software using two wires on the VGA or DVI cables.	Touch the ◀ or ▶ buttons to select the value.	On Off
DCR (Dynamic Contrast Ratio)	Activates DCR. This feature provides automatic adjustment of picture brightness and contrast at high speed and dynamic contrast range, such as when watching movies. DCR is suitable for indoor viewing.	Touch the ◀ or ▶ buttons to select the value.	On Off
Recall	Use to recall all to default settings, except Language, PIP, and the input source.	Touch the ▶ button.	-





ADJUSTING THE LCD DISPLAY



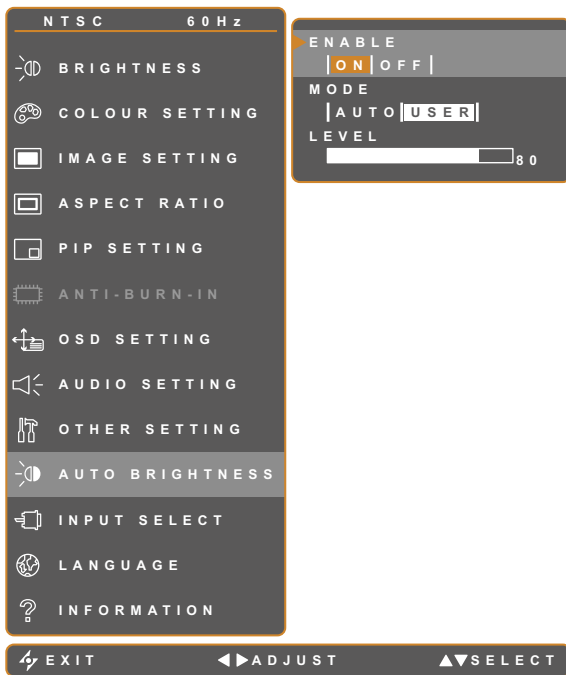



5.10 Auto Brightness

5.10.1 EcoSmart Sensor

With the built-in EcoSmart sensor, users can enable the Auto Brightness feature to automatically adjust the LCD screen brightness according to the ambient light. This feature comforts the eyes and helps optimise energy efficiency.







1. Touch  to call out the OSD window.
2. Select AUTO BRIGHTNESS menu, then touch the  button.
3. Touch the  or  buttons to select an option.

Item	Function	Operation	Value
Enable	Enables or disables auto brightness.	Touch the  or  buttons to select the value.	On Off
Mode	Sets the auto brightness mode.	Touch the  or  buttons to select the value.	Auto User
	The mode can be set to: <ul style="list-style-type: none"> • Auto - This mode is the default mode. The LCD brightness automatically adjusts to the ambient brightness. • User - Allows you to manually adjust the LCD brightness. 		
Level	Allows you to set the level of LCD brightness. Available only in USER mode.	Touch the  or  buttons to adjust the value.	0 to 100

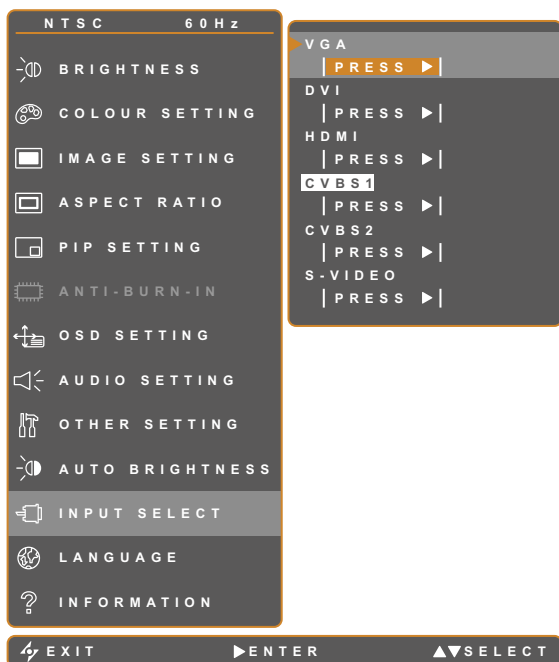
ADJUSTING THE LCD DISPLAY

5.11 Input Select





1. Touch  to call out the OSD window.
2. Select INPUT SELECT menu, then touch the  button.
3. Touch the  or  buttons to select an option.

Item	Function	Operation	Value
VGA	Sets VGA as the input source signal.	Touch the  button to select.	-
DVI	Sets DVI as the input source signal.		
HDMI	Sets HDMI as the input source signal.		
CVBS1	Sets CVBS1 as the input source signal.		
CVBS2	Sets CVBS2 as the input source signal.		
S-VIDEO	Sets S-Video as the input source signal.		

CHAPTER 6: APPENDIX

6.1 Warning Messages

Warning Messages	Cause	Solution
	The resolution or the refresh rate of the graphics card of the computer is set too high.	<ul style="list-style-type: none">• Change the resolution or the refresh rate of the graphics card.
	The LCD display cannot detect the input source signal.	<ul style="list-style-type: none">• Check if the input source is turned ON.• Check if the signal cable is properly connected.• Check if any pin inside the cable connector is twisted or broken.
	The OSD has been locked by the user.	<ul style="list-style-type: none">• Unlock the OSD. Refer to page 18.

APPENDIX

6.2 Troubleshooting

Problem	Possible Cause and Solution
No picture. <ul style="list-style-type: none"> • LED indicator is OFF. 	<ul style="list-style-type: none"> • Check if the LCD display is turned ON. • Check if the power cord is properly connected to the LCD display. • Check if the power cord is plugged into the power outlet.
<ul style="list-style-type: none"> • LED indicator is AMBER. 	<ul style="list-style-type: none"> • Check if the computer is turned ON. • Check if the computer is in standby mode, move the mouse or press any key to wake up the computer.
Image position is incorrect.	<ul style="list-style-type: none"> • Adjust the H. POSITION and V. POSITION values. See IMAGE SETTING on page 30 (for VGA source) or page 31 (for video signals).
The displayed texts are blurry.	<ul style="list-style-type: none"> • For VGA input, touch  on the keypad to auto-adjust the display. • Adjust the IMAGE SETTING (see page 30).
The OSD menu can't be called out.	<ul style="list-style-type: none"> • The OSD is locked; unlock the OSD (see page 18).
Red, blue, green, white dots appear on screen.	<ul style="list-style-type: none"> • There are millions of micro transistors inside the LCD display. It is normal for a few transistors to be damaged and to produce spots. This is acceptable and is not considered a failure.
No audio output.	<ul style="list-style-type: none"> • Check if the volume is set to 0 (see page 18 or 36). • Check if AUDIO is set to OFF (see page 36). • For VGA or DVI input, check the audio setting of the computer.
PIP mode does not work.	<ul style="list-style-type: none"> • The main and sub input source signals are not compatible to be displayed together in PIP mode. Check the PIP Compatibility Table for details (see page 34).
Cannot adjust Backlight setting.	<ul style="list-style-type: none"> • AUTO BRIGHTNESS setting is ON, disable AUTO BRIGHTNESS (see page 39).
The displayed picture looks distorted.	<ul style="list-style-type: none"> • Adjust the aspect ratio (see page 32).
Dew formed on or inside the LCD display.	<ul style="list-style-type: none"> • This normally happens when the LCD display is moved a cold room to a hot room temperature. Do not turn ON the LCD display, wait for the dew condensation to disappear.
Mist formed inside the glass surface.	<ul style="list-style-type: none"> • This happens due to humid weather conditions. This is a normal occurrence. The mist will disappear after a few days or as soon as the weather stabilizes.

APPENDIX

Problem	Possible Cause and Solution
Faint shadows from a static image appear on the screen.	<ul style="list-style-type: none">• Turn off the LCD display for extended periods of time.• Use a screen saver or a black and white image and run it for extended periods of time.

APPENDIX

6.3 Transporting the LCD Display

To transport the LCD display for repair or shipment, place the display in its original packaging carton.

- 1 Put all the accessories in the box (if necessary). Place the two foam cushions on each side of the LCD display for protection.**
- 2 Place the LCD display down in the box.**
- 3 Place the accessories box on the designated area (if necessary).**
- 4 Close and tape the box.**

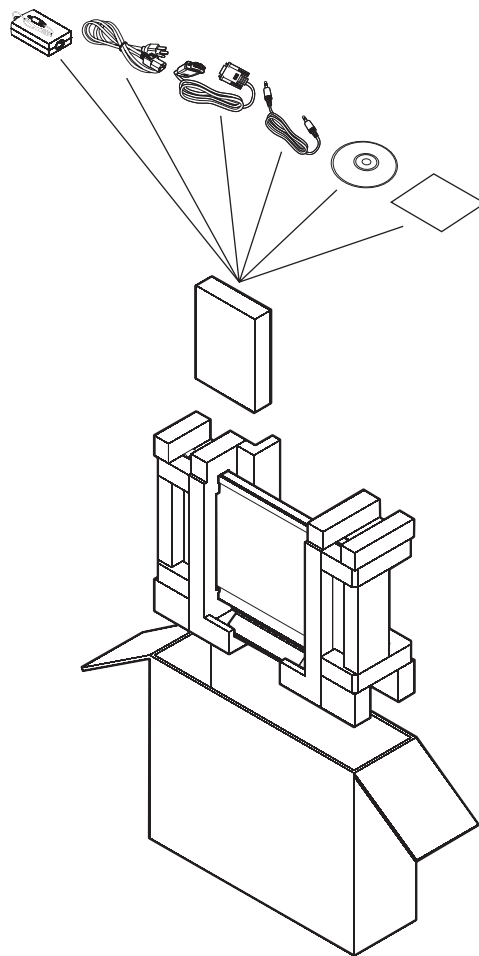

CHAPTER 7: SPECIFICATIONS

7.1 Display Specifications

DR-22		
Panel	Panel Size	21.5"
	Max. Resolution	FHD 1920 x 1080
	Pixel Pitch	0.2482 mm
	Brightness	250cd/m ²
	Contrast Ratio	2,000,000:1 (DCR)
	Viewing Angle (H/V)	170°/160° (Typical)
	Display Colour	16.7M
	Response Time	3ms (GTG)
	Frequency (H/V)	H: 30 kHz - 82 kHz V: 56 Hz - 75 Hz
Input	VGA	15-Pin D-Sub
	DVI	24-Pin DVI-D
	CVBS	RCA x 2
	S-Video	4-Pin mini DIN
	HDMI	HDMI
Audio	Audio In	1 x stereo audio in for PC (audio jack, 3.5 Ø) 1 x stereo audio in for CVBS or S-VIDEO (RCA)
	Speaker Out	1.5W x 2
Power In	Power Supply	External
	Power Requirements	DC 24V, 2A
	Consumption	< 25W (On)
		< 3W (Active Off) < 1W (Off)
Operating Conditions	Temperature	0 °C ~ 40 °C (32 °F ~ 104 °F)
	Humidity	10% ~ 90%
	Altitude	3000M
	Pressure	700hPa ~ 1060 hPa
Storage Conditions	Temperature	-20 °C ~ 60 °C (-4 °F ~ 140 °F)
	Humidity	5% ~ 95%
Weight	Without Base	6.3 kg (13.9 lbs)
	With Base	6.9 kg (15.2 lbs)

Note: All specifications are subject to change without prior notice.

SPECIFICATIONS

7.2 Display Dimensions

