

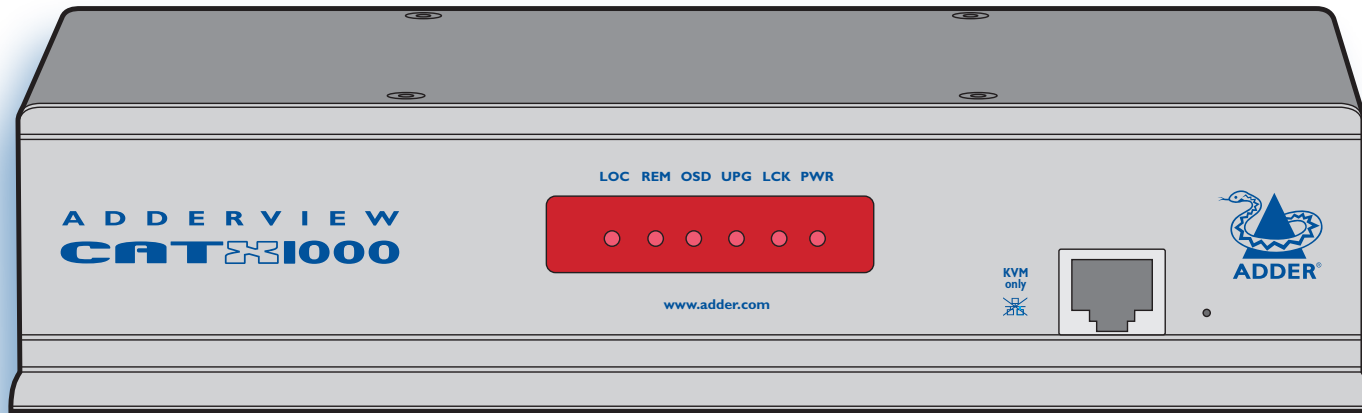

AdderView CATx 1000

User Guide



CONTENTS

Contents



Introduction

AdderView CATx 1000 features - front and rear	4
What's in the box.....	5
What you may additionally need	5

Installation

Mounting	6
Connections	7
Local user	8
Remote user (via X100/X200 extender)	9
Computer system (via CAM)	10
Power in connection	11
Power control port	12
Cascading multiple units	13
Connecting units in cascade	14
Addressing computers in a cascade	15
Using cascaded computers.....	15
Multiple video head connections	16
Remote switching control	17

Configuration

Overall initial configuration	18
Configuration menus	19
Configuration menus layout	20
General security and configuration steps	20
Registering users (edit user list).....	21
Registering computers (edit computer list)	22
Video compensation.....	23
Remote user video compensation	23
Remote user skew adjustment.....	24
Autoscanning.....	26
Saving and restoring configuration settings	27
What to do if the ADMIN password has been forgotten...29	
Power switching configuration	30
Performing upgrades	31
Upgrading AdderView CATx 1000 units and CAMs	31

INSTALLATION

CONFIGURATION

OPERATION

FURTHER INFORMATION

INDEX

Operation

Local and remote user access.....	33
Selecting a computer.....	33
User arbitration - simultaneous local and remote users.....	35
Logging in and out.....	36
Selecting cascaded computers.....	36
The confirmation box.....	37
The reminder banner.....	37
Power switching (via configuration menu).....	38
User preferences and functions.....	38

Further information

Getting assistance.....	39
Appendix 1 – Configuration menus.....	40
Functions.....	41
User Preferences.....	42
Global Preferences.....	43
Setup Options.....	45
Advanced Options.....	46
Appendix 2 – Cable and connector specifications.....	48
AdderView CATx 1000 to power switch cable.....	48
Power switch to power switch daisy chain cable.....	48
Multi-head synchronisation cable.....	48
Warranty.....	49
Safety information.....	49
Radio Frequency Energy.....	50

Index



INSTALLATION
CONFIGURATION
OPERATION
FURTHER INFORMATION
INDEX

Introduction



Thank you for choosing the AdderView CATx 1000 from Adder Technology. This compact unit has been created to allow a single operator to take full control of many computer systems.

Like the other models within the highly successful AdderView CATx family, this unit takes full advantage of category 5, 5e or 6 structured cabling to provide flexible installation and configuration. Every connected computer can be up to 10m (32 feet) from the AdderView CATx 1000, linked by a standard CATx cable and the ingenious CAM (Computer Access Module).

The AdderView CATx 1000 is available in two sizes, directly supporting eight or sixteen computers respectively. These numbers can be increased at any time thanks to the ability to connect other AdderView CATx 1000 units in cascade to provide a much larger network of controlled computers. Both models provide full enterprise level security to restrict access to authorised personnel.

Optional power switch control allows you to remotely perform a hard reset on any host system, no matter how badly it has locked up.

The user console can be either connected directly to the AdderView CATx 1000 unit or placed up to 300m (980 feet) away using either Adder X100 or X200 extenders and, once again, standard CATx cabling. In addition to providing the usual keyboard, video and mouse signals, the AdderView CATx 1000 also provides audio output for full feedback where necessary.

Remote user

A remote user can be linked, via an Adder X100 or X200 extender and category 5, 5e or 6 cabling, to a maximum distance of 300m (980 ft).

Local user

One user can be connected directly to the AdderView CATx 1000.

Dual users

When both a local and a remote user are connected, both consoles will see the same output, however, only one will be able to take control at any one time. Control is automatically relinquished by the current user two seconds after the last input action, whereupon either user can gain control. The control status is signified by the keyboard indicators at each console.

Many computers

AdderView CATx 1000 units can directly support either 8 or 16 computer systems. Multiple AdderView CATx 1000 units can also be cascaded to support a maximum of 256 computers.

Each system is linked using a Computer Access Module (CAM) and category 5, 5e or 6 cabling to a maximum distance of 10m (32 ft) from the AdderView CATx 1000 unit.

CAM formats

The CAMs are available in different formats to support all common types of systems, which can easily be mixed within a multi-format configuration.

Optional power control

You have the opportunity to attach one or more power switches. These control the supply to the system(s) and allow a remote user to hard reset any system that has suffered a failure.

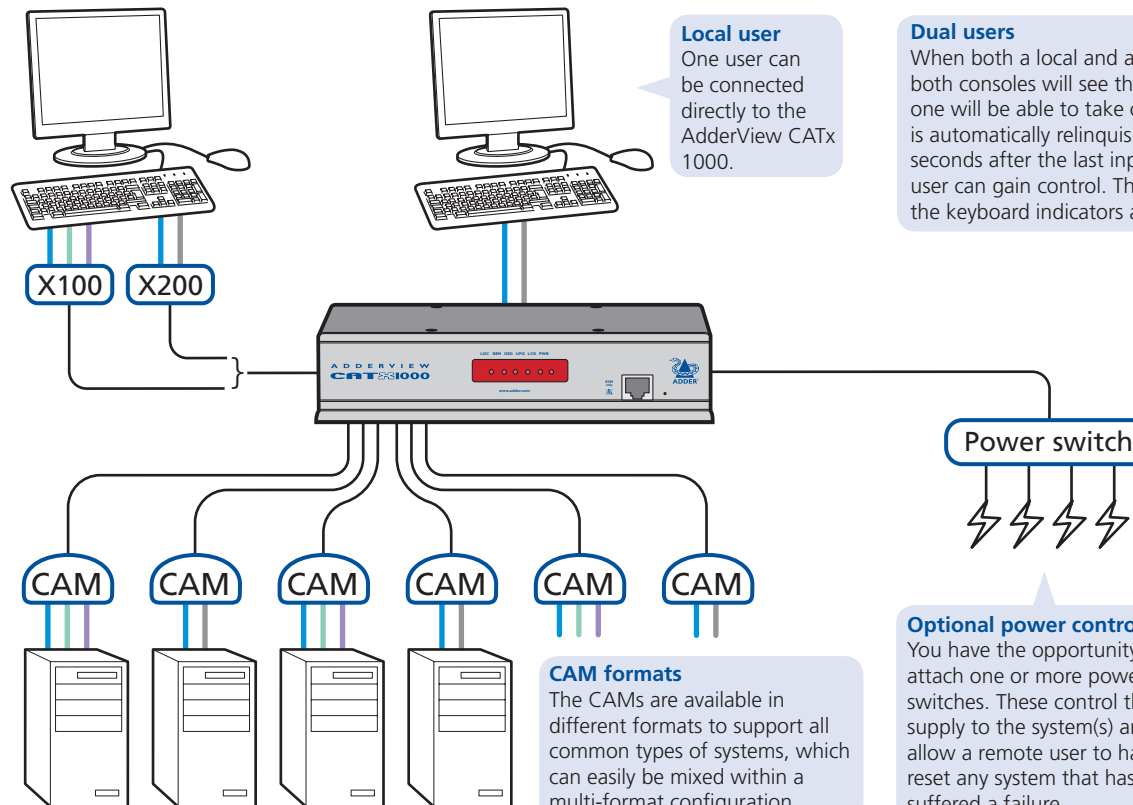

AdderView CATx 1000 features - front and rear

The AdderView CATx 1000 units pack a great deal of functionality into a compact space. Both models occupy half of a single 1U rack space and provide most of their connectors at the rear face. The smart front face features the remote user link port and the operation indicators.

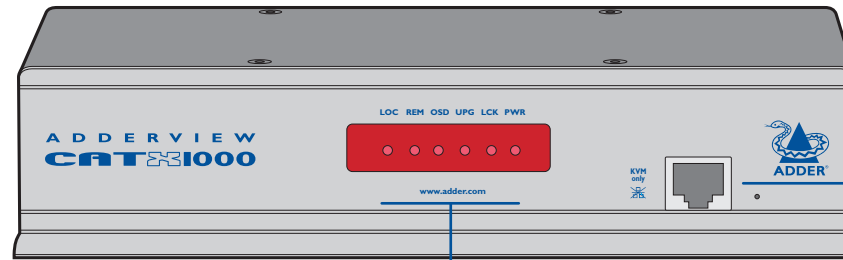

Remote user port

This port can either be used to connect a single remote user (with an optional X100 or X200 extender module) at a distance of up to 300m or used to connect other AdderView CATx 1000 units in cascade.

IMPORTANT: This is not an Ethernet port and must not be connected to any network.

Indicators

These six indicators clearly show the key aspects of operation:

- **LOC** Keyboard or mouse data are being received from the local console.
- **REM** Keyboard or mouse data are being received from the remote console.
- **OSD** Indicates that the on screen display is currently active.
- **UPG** Indicates that the unit is currently in upgrade mode.
- **LCK** Security mode enabled and no user logged in.
- **PWR** Power input indicator.

Options port

This RS232 serial port can separately support the following functions:

- Power switching - can be configured to control multiple power switching devices.
- Remote control switching - commands can be received that will change the channel, as necessary.
- Synchronisation - allows the actions of two or more AdderView CATx 1000 switches to be synchronised so that multiple computers/video screens can be switched and accessed.
- Upgrades - used to update the internal firmware when necessary by connecting to a computer.
- Transferring configuration settings - allows information about the connected computers to be saved and restored.

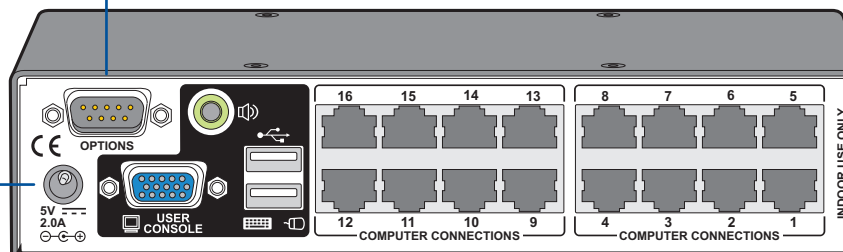

Power input
The power supply connects here.

Local user port

Connect a USB keyboard and mouse, plus a video monitor and optional speakers to these connectors. These allow you to perform the initial configuration of the AdderView CATx 1000. Additionally, you can use these to locally control the connected computer(s).

Computer ports

Each computer connects to one of these ports via standard category 5, 5e or 6 cabling. At the other end of the cabling a CAM (Computer Access Module) is used to provide the necessary keyboard, video, mouse and optional speaker connections.

INSTALLATION

CONFIGURATION

OPERATION

FURTHER INFORMATION

INDEX

What's in the box

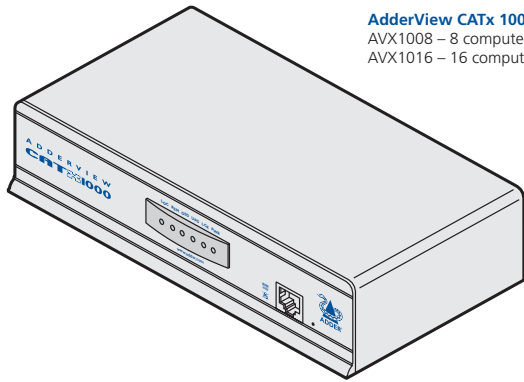

AdderView CATx 1000

AVX1008 – 8 computer connections, 1 local console connection, 1 remote user connection
 AVX1016 – 16 computer connections, 1 local console connection, 1 remote user connection

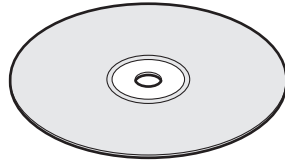

CD-ROM

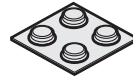

Four self-adhesive rubber feet

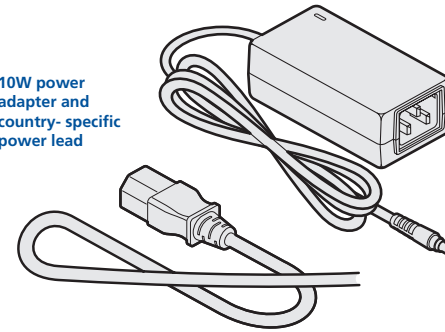

10W power adapter and country-specific power lead

What you may additionally need

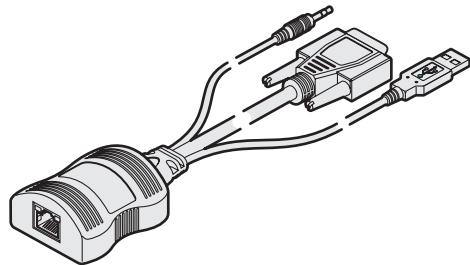

Computer Access Modules

One required per connected computer. There are five different formats, depending on the required computer connections:

PS/2-style

Connectors: Analog video, PS/2-style keyboard and PS/2-style mouse.

Part number: CATX-PS2

PS/2-style with audio

Connectors: Analog video, PS/2-style keyboard, PS/2-style mouse and 3.5mm audio jack.

Part number: CATX-PS2A

USB

Connectors: Analog video and USB keyboard/mouse.

Part number: CATX-USB

USB with audio

Connectors: Analog video, USB keyboard/mouse and 3.5mm audio jack.

Part number: CATX-USBA

Sun with audio

Connectors: Analog video, Sun keyboard/mouse and 3.5mm audio jack.

Part number: CATX-SUNA

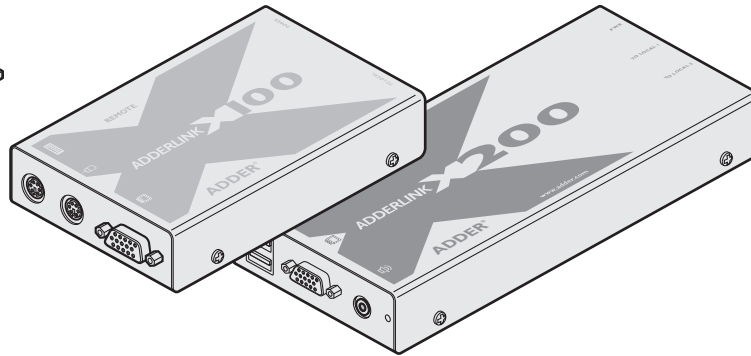

Adder X100/X200 extenders

One extender required per remote user. X200 units are similar to X100 except that they can accommodate a second link to another switch or computer. X200 units also have USB connections rather than PS/2-style keyboard and mouse ports. Three different variants are available for each X100 or X200 unit - AS/R variants have audio and video skew circuitry to overcome extreme video degradation problems. A/R variants lack the skew circuitry and R variants do not have skew circuitry or audio. Each module is supplied with its own power adapter and country-specific power lead.

Adder X100/R

Connectors: Analog video, PS/2-style keyboard and PS/2-style mouse.

Part number: X100R

Adder X100A/R

Connectors: Analog video, PS/2-style keyboard, PS/2-style mouse and 3.5mm audio jack.

Part number: X100A/R

Adder X100AS/R

Connectors: Analog video, PS/2-style keyboard, PS/2-style mouse and 3.5mm audio jack. Includes additional skew compensation features.

Part number: X100AS/R

Adder X200/R

Connectors: Analog video, USB keyboard and USB mouse.

Part number: X200R

Adder X200A/R

Connectors: Analog video, USB keyboard, USB mouse and 3.5mm audio jack.

Part number: X200A/R

Adder X200AS/R

Connectors: Analog video, USB keyboard, USB mouse and 3.5mm audio jack. Includes additional skew compensation features.

Part number: X200AS/R

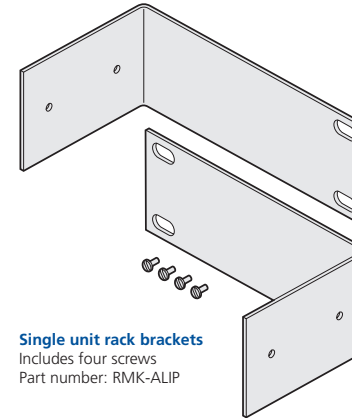

Single unit rack brackets

Includes four screws

Part number: RMK-ALIP

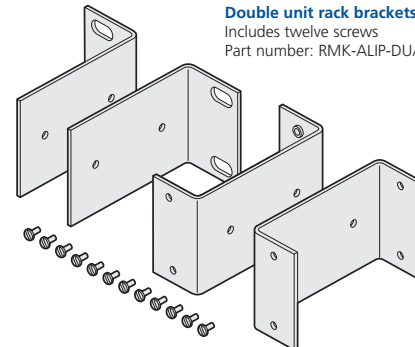

Double unit rack brackets

Includes twelve screws

Part number: RMK-ALIP-DUAL

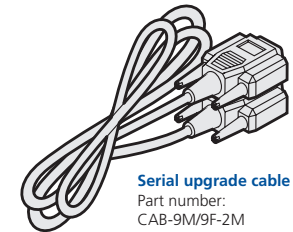

Serial upgrade cable

Part number: CAB-9M/9F-2M

Slave power switches for connection to AdderView CATx 1000 or master power switch

Part number: EPS-S8 (not available in North America)

Master power switch for connection to AdderView CATx 1000 or standalone Ethernet operation

Part number: EPS-M8 (not available in North America)

- INSTALLATION
- CONFIGURATION
- OPERATION
- FURTHER INFORMATION
- INDEX

Installation

Mounting

The AdderView CATx 1000 units offer three main mounting methods:

- Supplied four self-adhesive rubber feet
- Optional single unit rack brackets
- Optional double unit rack brackets

Connections

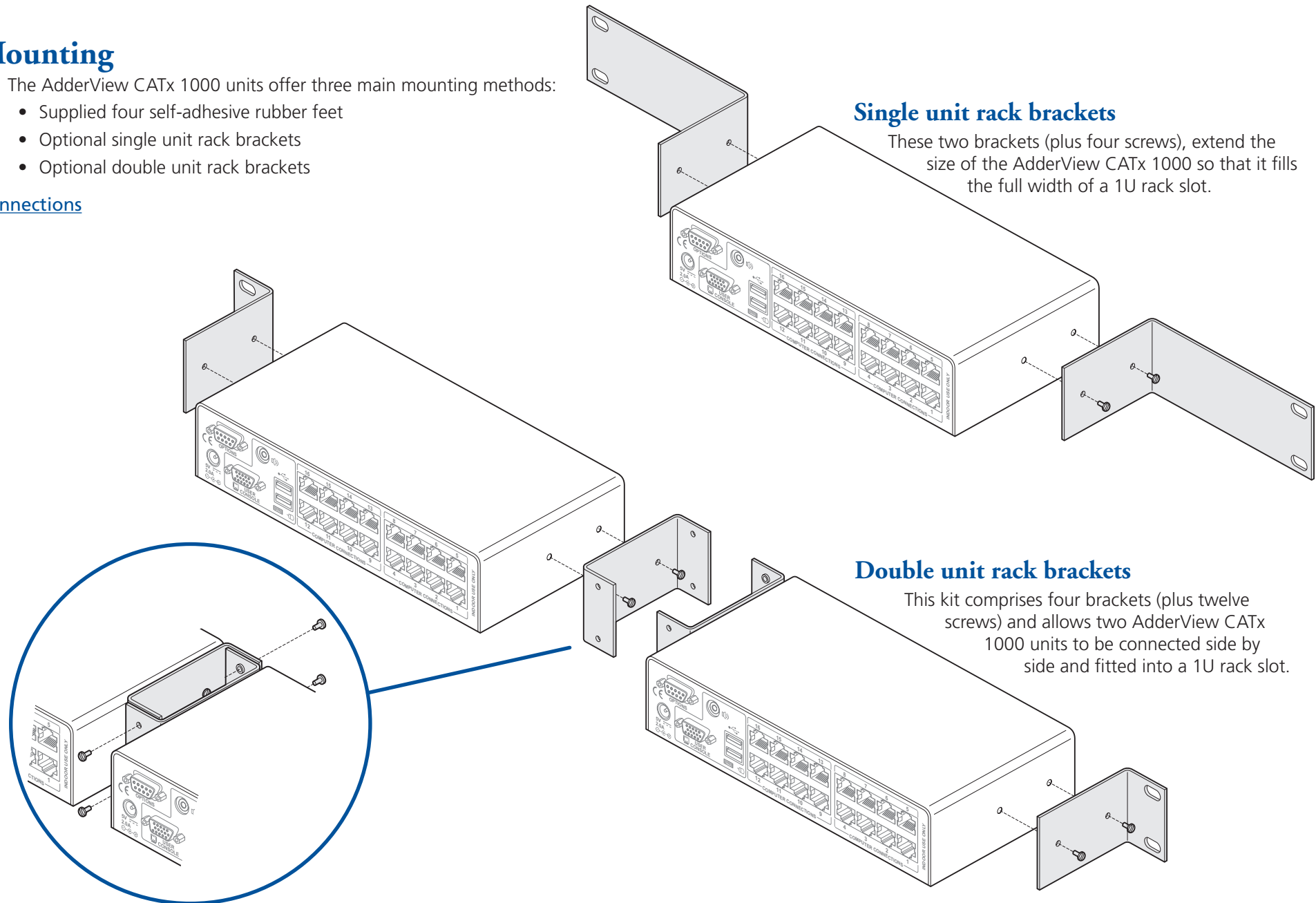

Single unit rack brackets

These two brackets (plus four screws), extend the size of the AdderView CATx 1000 so that it fills the full width of a 1U rack slot.

Double unit rack brackets

This kit comprises four brackets (plus twelve screws) and allows two AdderView CATx 1000 units to be connected side by side and fitted into a 1U rack slot.

Connections

The AdderView CATx 1000 provides a great deal of flexibility in its configurations. This chapter details the various connections that can be made to achieve the required installation.

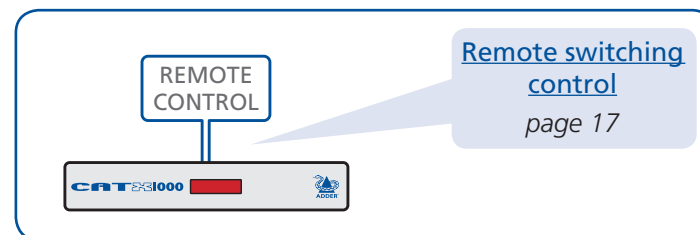
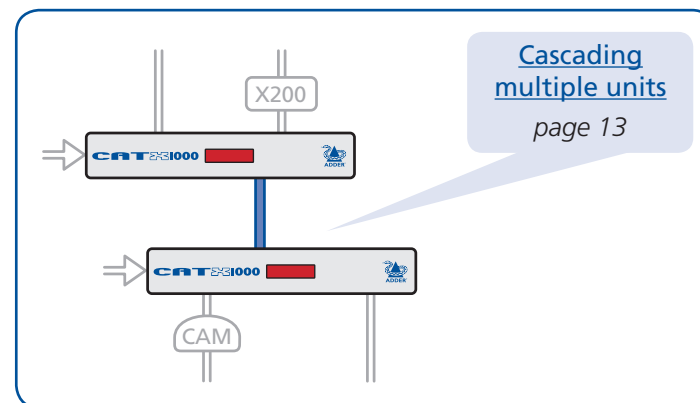
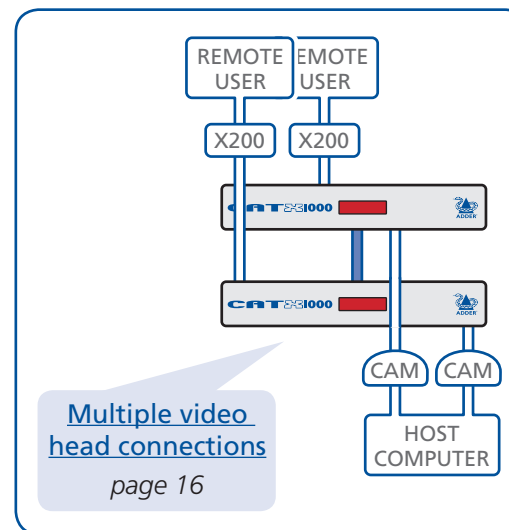
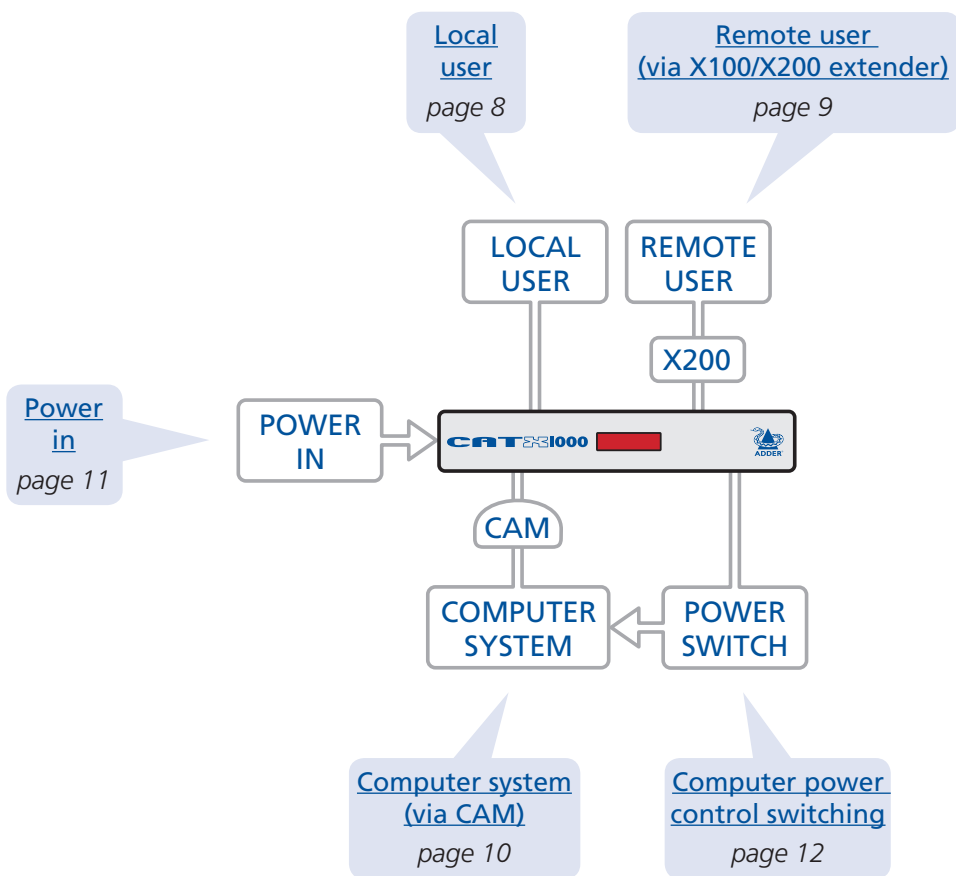

Connections do not need to be carried out in the order given within this guide, however, where possible connect the *power in* as a final step.

INSTALLATION

CONFIGURATION

OPERATION

FURTHER INFORMATION

INDEX

Local user

A locally connected video monitor, keyboard (and mouse) are required during the initial configuration. These are also useful during normal use to allow quick local control of any connected computer systems. The AdderView CATx 1000 unit directly supports USB style keyboards and mice. An audio port is also provided for locally connected speakers, if required.

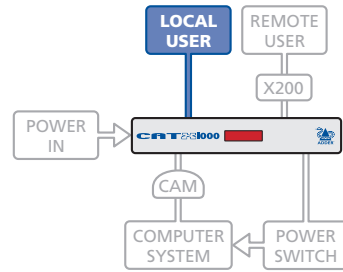

To connect the local user port

- 1 Position a suitable video monitor, keyboard, mouse (and speakers, if required) in the vicinity of the AdderView CATx 1000 unit such that their cables will easily reach.
- 2 Attach the video monitor, keyboard, mouse (and speaker) connectors to the sockets, collectively labelled as USER CONSOLE, at the rear of the AdderView CATx 1000 unit.

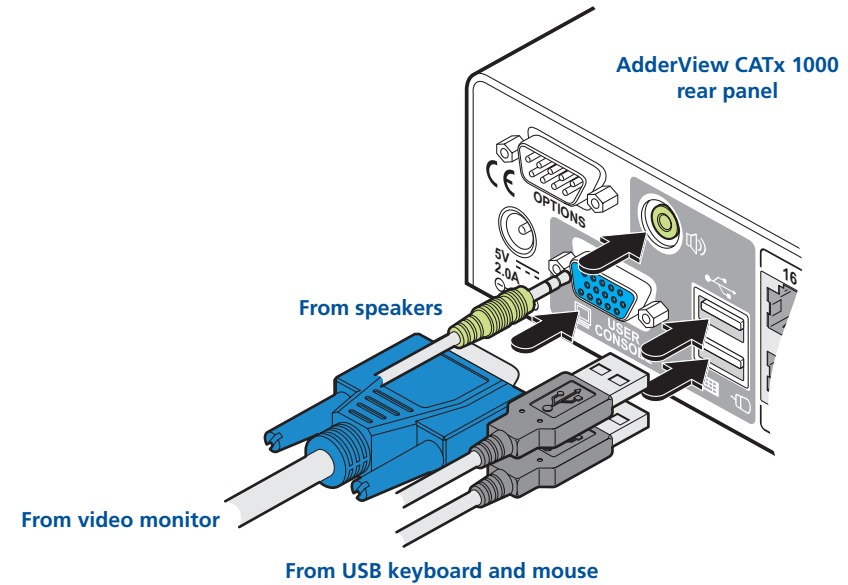

Remote user (via X100/X200 extender)

One user can be placed a maximum of 300 metres (980 feet) from the AdderView CATx 1000 unit. The remote user is connected via an Adder X100 or X200 extender module and suitable category 5, 5e or 6 cabling (with no crossover).

Note: It is not possible to connect a remote user while the unit is cascaded to another unit.

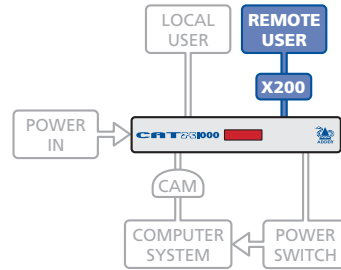

Cable lengths for remote user locations

The maximum length of cable between the remote user and the AdderView CATx 1000 unit can be up to 300 metres (980 feet). However, bear in mind that the overall distance between the remote user and any computer system must not exceed 300 metres (980 feet).

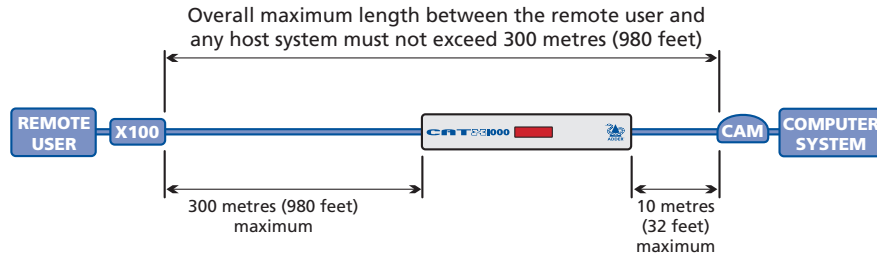

In situations where any computer system will be placed a significant distance from the AdderView CATx 1000 unit, ensure that the distance to any remote user is similarly less than 300 metres (980 feet).

To connect a remote user

- 1 Place an Adder X100 or X200 extender unit adjacent to the remote user location.
- 2 Attach the video monitor, keyboard, mouse, power adapter (and speaker) connectors to the sockets of the Adder X100 or X200 module.

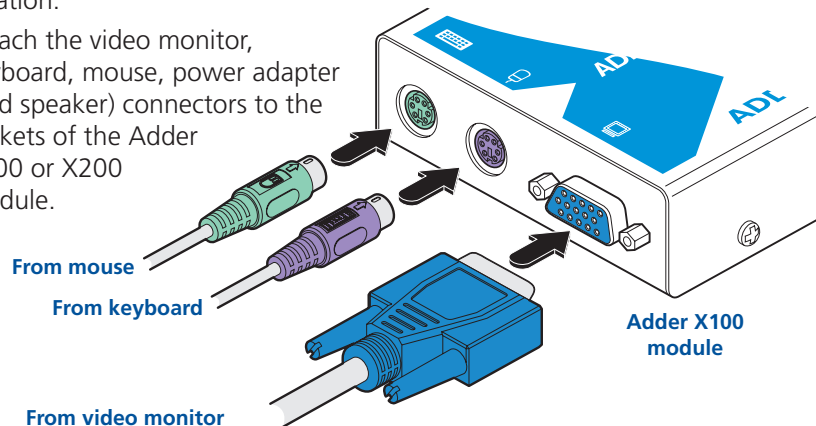

- 3 Lay a suitable length of category 5, 5e or 6 cabling between the Adder X100/X200 module and the AdderView CATx 1000 unit. Please refer to the section *Cable lengths for remote user locations* opposite.
- 4 Attach the connector of the cable run to the socket of the Adder X100/X200.

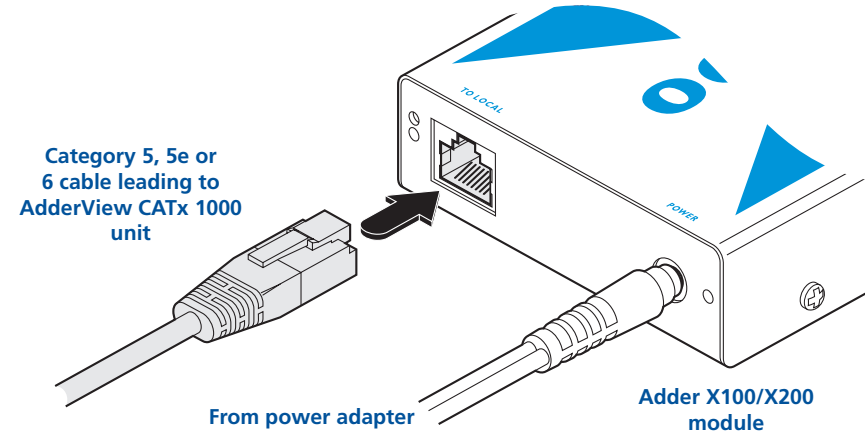

- 5 At the other end of the cable run, attach the cable connector to the socket on the front panel of the AdderView CATx 1000 unit.

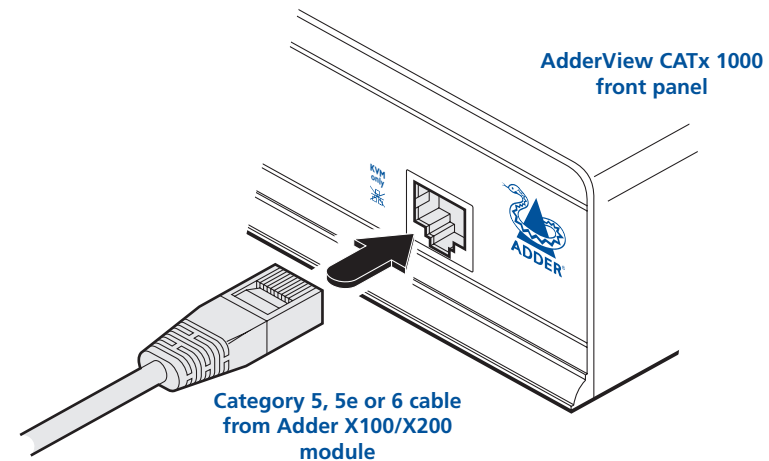

- 6 Where necessary, use the in-built video compensation feature of the Adder X100/X200 module to eliminate any effects caused by the cable run.



INSTALLATION

CONFIGURATION

OPERATION

FURTHER INFORMATION

INDEX

Computer system (via CAM)

Each computer system is connected to the AdderView CATx 1000 unit via a Computer Access Module (CAM) and standard category 5, 5e or 6 cabling. CAMs are available in various formats to suit differing computer system types and their particular connector styles.

Each CAM uses Adder Keep Alive technology to ensure that the keyboard and mouse inputs to the computer remain active, even when the particular channel is not selected. This action ensures that there are no connection delays or problems as the port is selected.

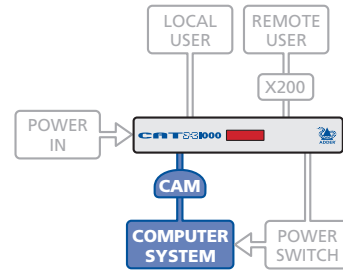

To connect a computer system

- 1 Ensure that power is disconnected from the AdderView CATx 1000 unit and the system to be connected.
- 2 Locate the required CAM (there are five types available) and attach its video, keyboard and mouse (PS/2-style, USB or Sun) and optional audio connectors to the relevant sockets on the computer system.

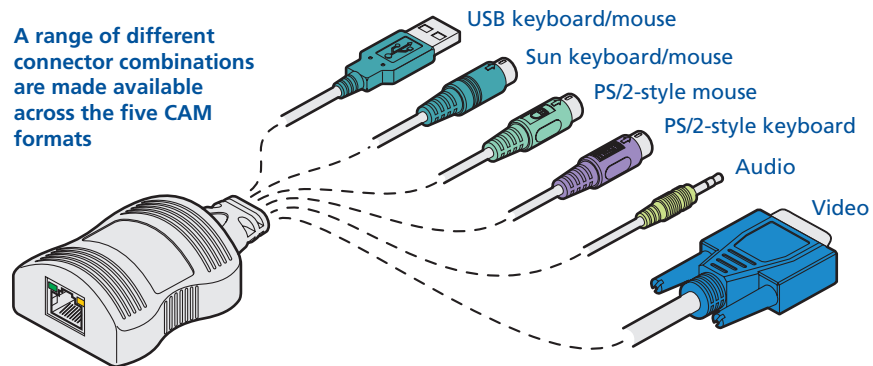

- 3 Lay a suitable length of category 5, 5e or 6 cabling between the computer system and the AdderView CATx 1000 unit. The maximum length of the cable can be up to 10 metres (32 feet), however, bear in mind that the overall distance between a remote user and any computer must not exceed 300 metres (980 feet).

- 4 Attach the connector of the cable run to the socket of the CAM.

Green indicator - power present
Yellow indicator - signal activity

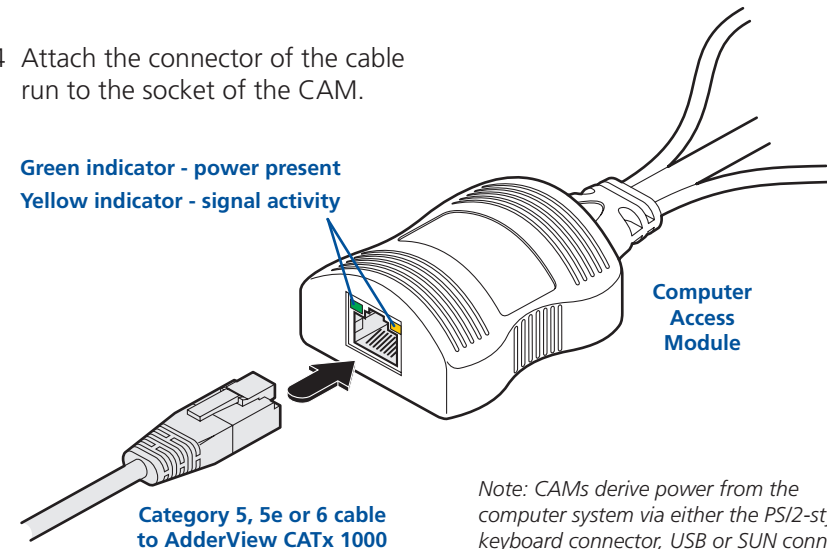

- 5 At the other end of the cable run, attach the cable connector to one of the sockets labelled COMPUTER CONNECTIONS on the rear panel of the AdderView CATx 1000 unit.

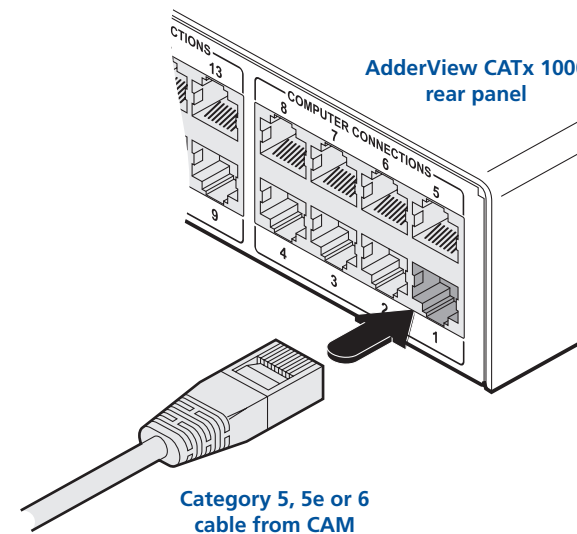

Power in connection

The AdderView CATx 1000 unit is supplied with a standard 10W power adapter. There is no on/off switch on the unit, so operation begins as soon as a power adapter is connected.

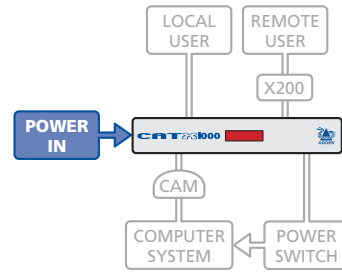

To connect the power supply

- 1 Attach the output lead from the power adapter to the 5V socket on the rear panel of the AdderView CATx 1000.

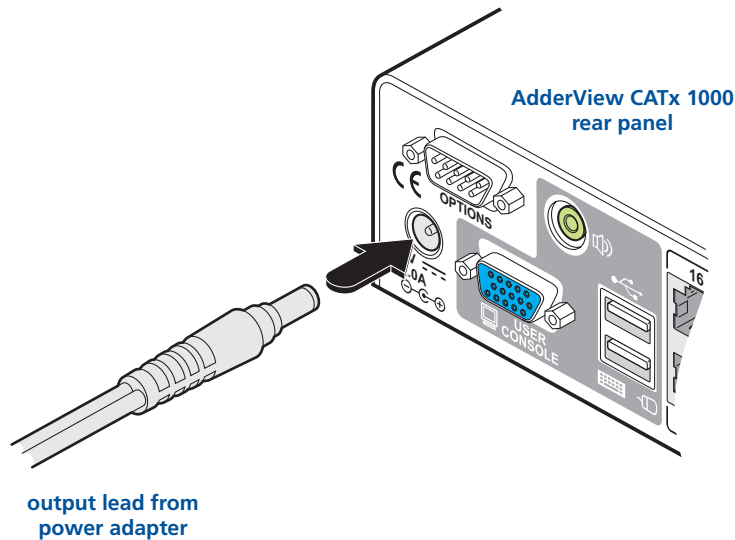

- 2 Connect the IEC connector of the supplied country-specific power lead to the socket of the power adapter.

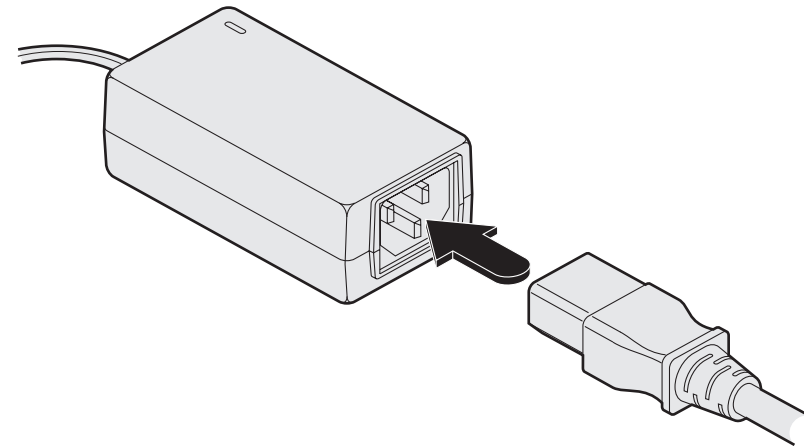

- 3 Connect the power lead to a nearby main supply socket.

Note: Both the AdderView CATx 1000 and its power supply generate heat when in operation and will become warm to the touch. Do not enclose them or place them locations where air cannot circulate to cool the equipment. Do not operate the equipment in ambient temperatures exceeding 40 degrees Centigrade. Do not place the products in contact with equipment whose surface temperature exceeds 40 degrees Centigrade.

Power control port

The options port of the AdderView CATx 1000 can be used to connect to one or more optional power control units. This allows you to control the mains power being supplied to the connected computer(s) so that an authorised user can, if necessary, perform a complete remote cold reboot on a failed system.

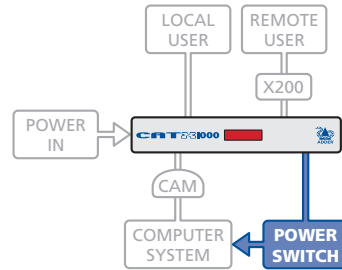

The control connector of the first power switch is attached, via serial cable, to the rear panel of the AdderView CATx 1000. Any additional power switches are then attached via a 'daisy-chain' arrangement to the first power switch. Each power switch box is then given a unique address and access to each power port (8 ports on each power switch box) is gained using a combination of the switch box address and the port number.

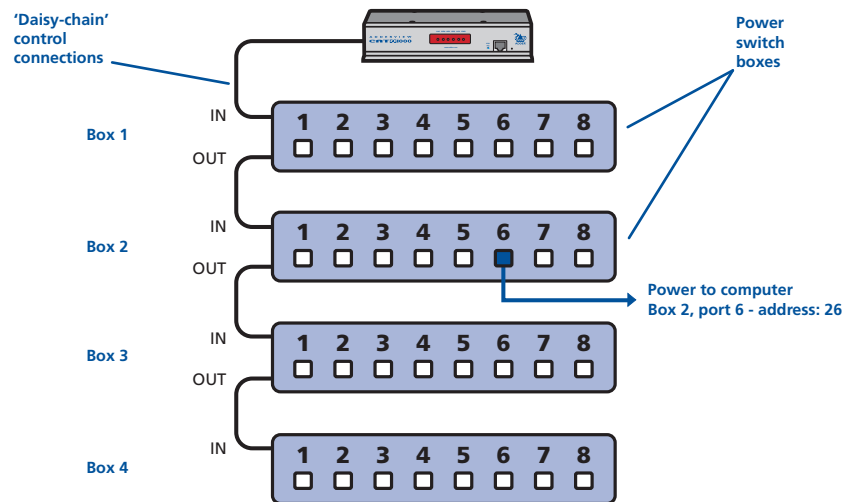

The power ports are connected to the power inputs of each computer system and the power switch box(es) are then connected to a mains power supply.

IMPORTANT: Power switching devices have a maximum current rating. It is essential to ensure that the total current drawn by the equipment connected to the power switching device does not exceed the current rating of the power switching device. You must also ensure that the current drawn from any mains socket does not exceed the current rating of the mains socket.

Setting up, configuring and using power switching requires three main steps:

- Connect and address the switch boxes ⇔
- [Configure the power strings](#)
- Operate power switching [via configuration menu](#)

To connect and address the switch boxes

Note: The AdderView CATx 1000 unit can be powered on during this procedure, however, the switch boxes should be switched off. The configuration steps below are for the Adder EPS-M8 and EPS-S8 power switches. Other power switches may require different configuration. Please refer to your power switch documentation.

- 1 Mount up to four switch boxes in positions where they are close to the computer systems that they will control and not too distant from the AdderView CATx 1000 unit (preferably within 2.5 metres).
- 2 Use a serial cable with an RJ9 and a 9-pin D-type connector (see [Appendix 2](#) for specification). Attach the RJ9 plug to the socket marked IN on the first switch box. Attach the other end to the socket marked OPTIONS on the AdderView CATx 1000.

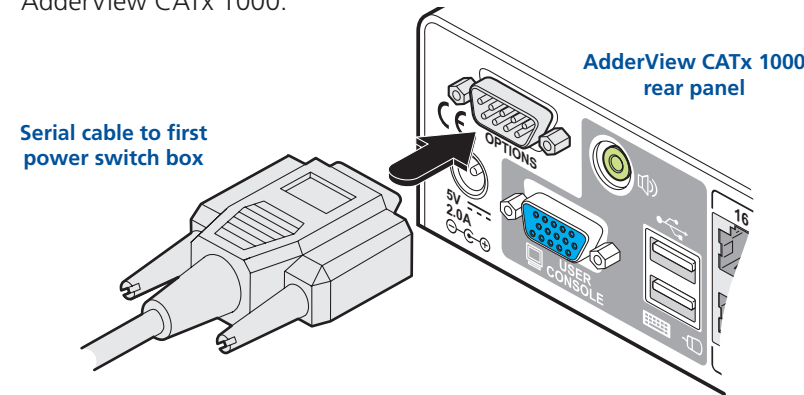

- 3 For each of the remaining switch boxes (if used), use a serial cable with RJ9 connectors at both ends (see [Appendix 2](#) for specification). Attach one end to the socket marked OUT of the previous box and the other end to the socket marked IN of the next box.

- 4 Set the addressing switches on each switch box using the two micro switches marked 'Slct' on the front panel. The box connected directly to the AdderView CATx 1000 is Box 1 and so on, down the daisy-chain line to Box 4 at the end.

Box	Switch 1	Switch 2
1	Off	Off
2	On	Off
3	Off	On
4	On	On

Off = switch upwards
On = switch downwards
Switch 1 is on the left side

- 5 Attach IEC to IEC power leads between each port and the power input socket of each computer system that requires power switching. Carefully note to which power ports, on which boxes, each computer system is connected. If computer systems have multiple power inputs, then each input must be connected via separate ports, which can be on the same, or different boxes.

- 6 Connect each box to a suitable mains power input.

Now proceed to the configuration stage covered in the [Power switching configuration](#) section within the Configuration chapter.



Cascading multiple units

The AdderView CATx 1000 units support up to eight or sixteen *directly* connected computer systems, however, this is by no means the limit. Instead of connecting computers to every output port, you can instead link other AdderView CATx 1000 units. Thus each output of the original AdderView CATx 1000 unit can link through to many more computers connected to the secondary units.

The combination of AdderView CATx 1000 units can be arranged two levels deep forming a tree, or *cascade* arrangement, with computer systems situated at either level within that cascade tree.

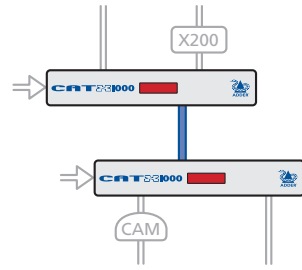

The cascade tree

The diagram shows how multiple AdderView CATx 1000 units can be cascaded to two levels. Computer systems can be connected at any level. The local or remote user can access computer systems situated anywhere within the cascade tree.

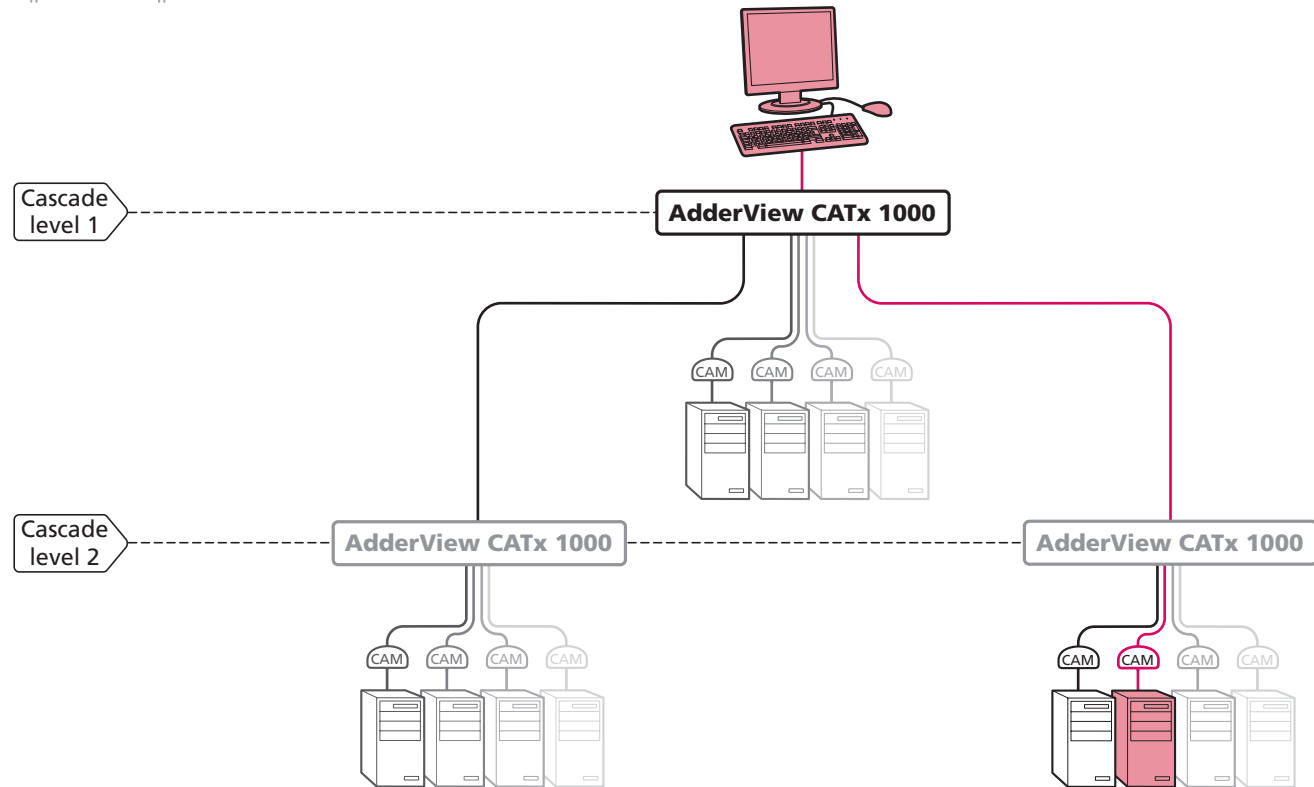

See also

- [Connecting units in cascade](#)
- [Addressing computers in a cascade](#)

Connecting units in cascade

The method for cascading AdderView CATx 1000 units is straightforward and requires no hardware settings or lengthy configuration process.

The method of linking AdderView CATx 1000 units is the same regardless of the cascade level, or number of devices attached. Put simply:

- A single cascade link is made by connecting a **COMPUTER CONNECTIONS** socket of one unit to the **REMOTE USER PORT** socket of the unit below it.

Please consider the following when making cascade connections between AdderView CATx 1000 units.

Tips for successful cascading

- The maximum number of levels for a cascade is two.
- For each cascade link, use a standard category 5, 5e or 6 twisted-pair cable, terminated at each end with an RJ45 connector. There must be no crossover connections within the cable. The cascade link cables can be up to 50m (160 feet) in length. However, remember that the overall length between the remote user (via an X100 or X200 extender) and any computer (via a CAM) must not exceed 300m (980 feet) - that figure includes the cascade link cables. Also ensure that the total length from the top AdderView CATx 1000 to any CAM does not exceed 10m.
- The procedure given opposite may be carried out in any order but for clarity the instruction will begin at the higher level AdderView CATx 1000 unit (here called the *upper unit*), i.e. the one that is being fed into by a unit at the cascade level below (here called the *lower unit*). The procedure remains the same regardless of exactly which cascade levels are being connected. The basic rule is that each link is made by connecting a **COMPUTER CONNECTIONS** port of the upper switch to a **CATx USER PORTS** of the lower switch.

To connect units in cascade

- 1 Ensure that power is disconnected from the AdderView CATx 1000 and all other units to be connected.
- 2 Connect one end of the cascade link cable to an appropriate **COMPUTER CONNECTIONS** port on the rear panel of the upper unit.

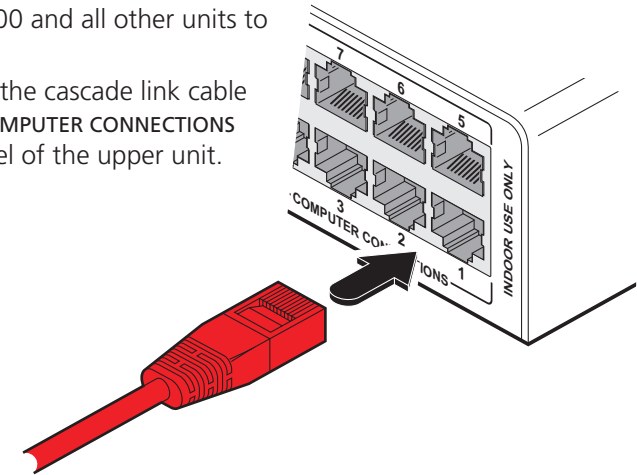

- 3 Connect the other end of the cascade link cable to the remote user RJ45 socket on the front panel of the lower unit.
- 4 Repeat steps 2 and 3 for the cascade links between each AdderView CATx 1000 unit.

Once the AdderView CATx 1000 units and computers have been connected, you can edit their names to make it much easier to locate them.

See the [To create/edit computer names](#) section in the Configuration chapter for more details.

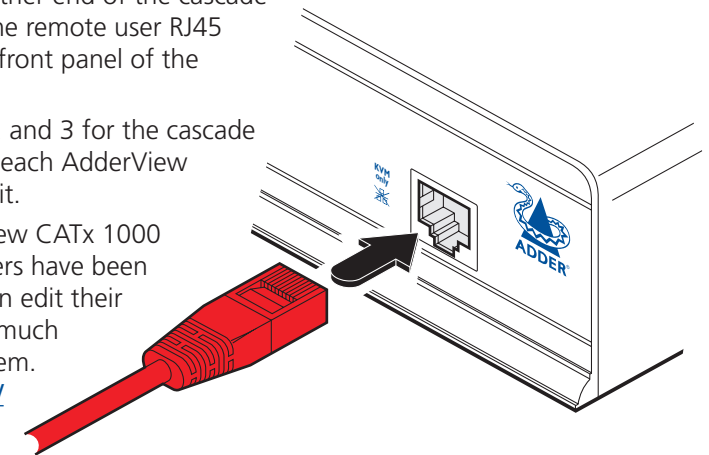

See also

- [Addressing computers in a cascade](#)

Addressing computers in a cascade

Computer systems connected within a cascade arrangement are addressed using up to four digits, two for each cascade level. The pairs of digits specify which of the COMPUTER CONNECTIONS ports on each of the AdderView CATx 1000 units must be enabled to reach a specific computer. In the diagram given here, a portion of the previous cascade diagram indicates how the routes to two particular computers are formed and addressed.

Each cascade level requires two digits, hence the computer marked in red requires a longer address (1203) as it is situated at cascade level 2, compared to the blue computer at the top level with its two digit port number.

The first time that you make a connection between two AdderView CATx 1000 units, the master unit will detect this and ask (via the on screen menu) if you want to automatically add computers. If you choose 'Yes' then the ports on the cascade will be automatically added to the on screen menu.

Using cascaded computers

In use, cascaded computers can be accessed using exactly the same methods as for those connected directly to the AdderView CATx 1000. However, by far the easiest way is to use the on screen menu. This is because it displays the computer names and does not require any knowledge of port addresses. See the [Selecting cascaded computers](#) section in the Operation chapter for more details.

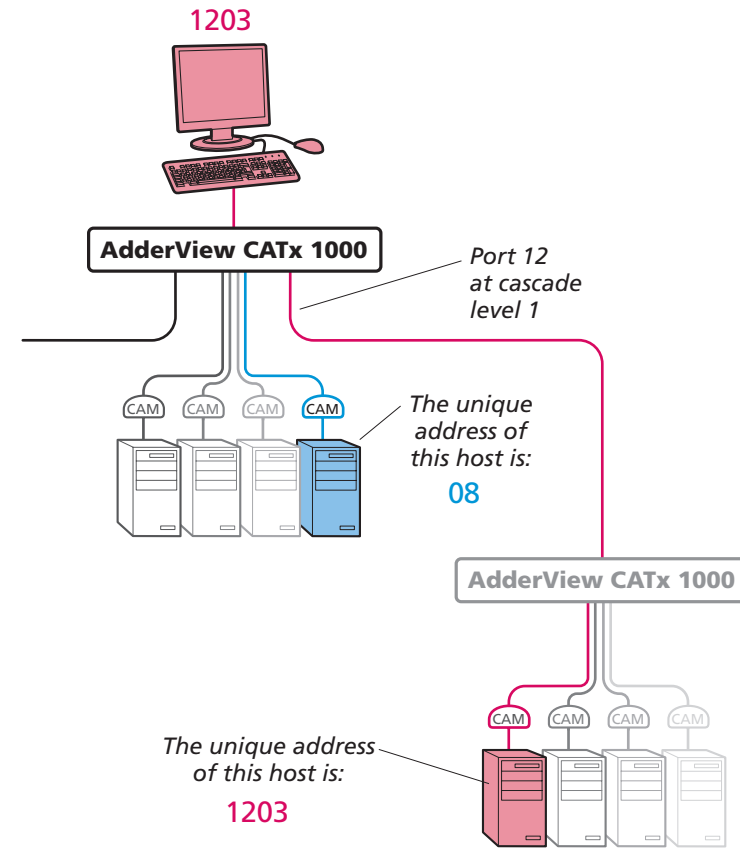

Multiple video head connections

Two or more AdderView CATx 1000 units can be connected together so that they operate in a synchronised manner. Synchronised operation is useful for applications that require multiple video signals to be switched together. This type of operation is usually required where each computer is fitted with multiple video cards or video cards with multiple video heads. Whenever an AdderView CATx 1000 channel is switched, it sends an RS232 command out on the serial interface (marked **OPTIONS** on the rear panel). An AdderView CATx 1000 will switch its channel if it receives the same command on the serial interface. Consequently, by linking the serial interfaces, a master unit may be made to automatically switch one or more slave units as shown in the diagram. It should be noted that the synchronisation cable deliberately does not have the transmit pin of the Slave End connector linked to the receive pin of the Master End connector. To do so would cause the Slave unit to be able to switch the Master unit. This would setup an endless cyclical switching sequence that would prevent the AdderView CATx 1000 devices from operating correctly. For more details about the serial synchronisation cables, see [Appendix 2](#).

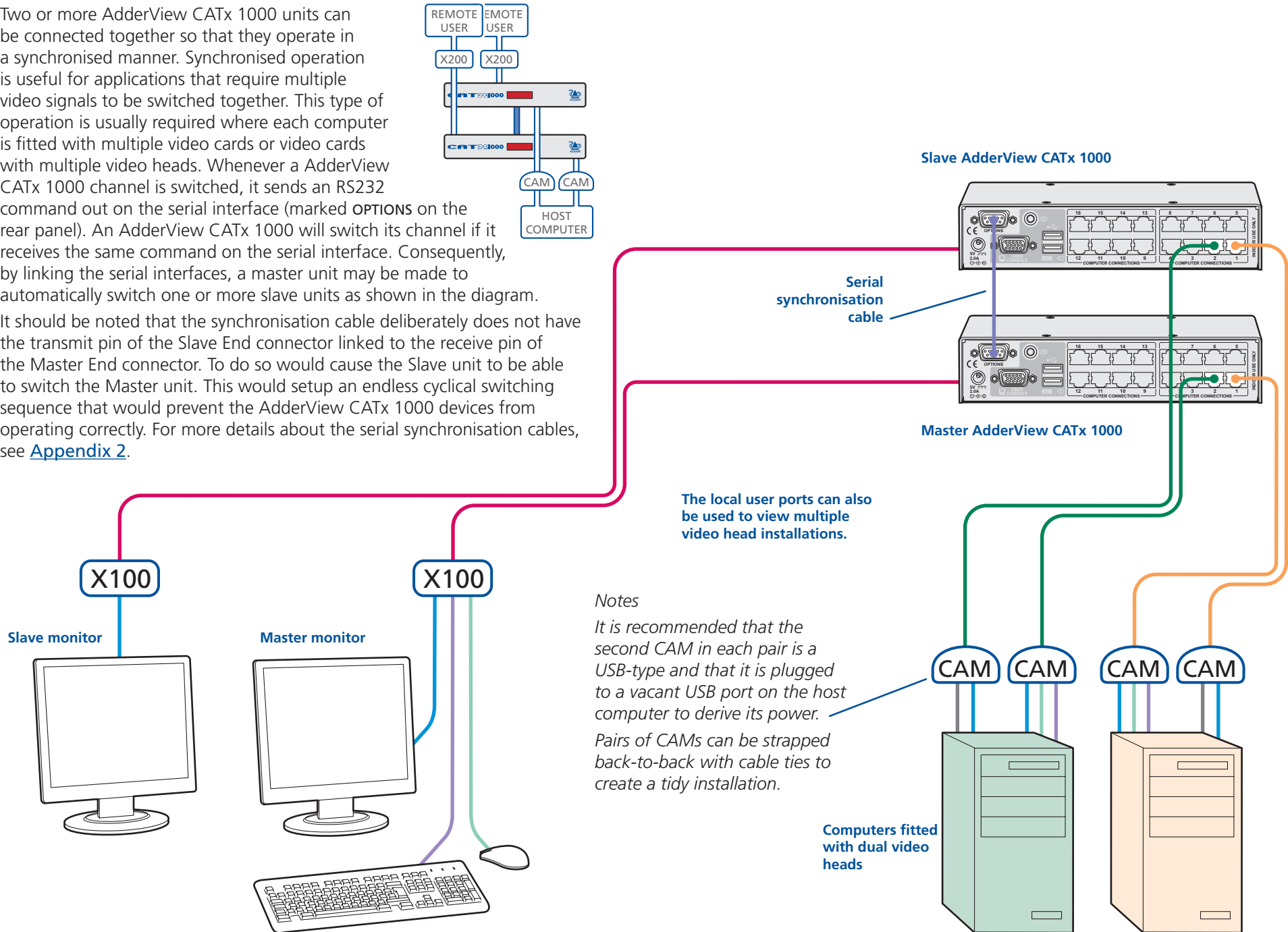

The local user ports can also be used to view multiple video head installations.

Notes
 It is recommended that the second CAM in each pair is a USB-type and that it is plugged to a vacant USB port on the host computer to derive its power.
 Pairs of CAMs can be strapped back-to-back with cable ties to create a tidy installation.

Remote switching control

The port switching functions of the AdderView CATx 1000 units can be remotely controlled by an RS232 link to the OPTIONS port on the rear panel.

The sending device must use the following RS232 communication settings:

Baud rate: 19200 bps
 Data bits: 8
 Parity: None
 Stop bits: 1

No handshaking is implemented, however, valid command characters will be echoed back to the sending device.

The value of the byte received via the serial link determines which computer port should be linked through to the user port. The table given here summarises the valid control codes:

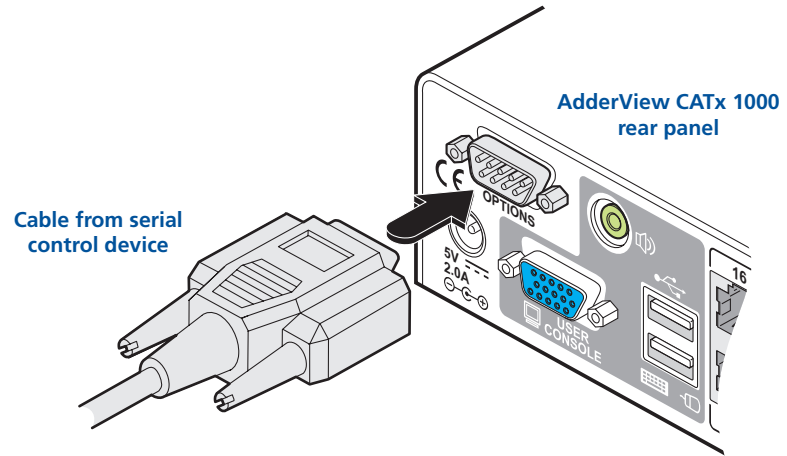
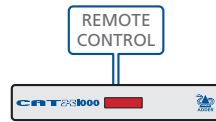

Host computer port/channel

1	2	3	4	5	6	7	8	9	10	11	12	13	14	15	16	0 (video off)
10	11	12	13	14	15	16	17	18	19	1A	1B	1C	1D	1E	1F	71

Configuration



Almost all configuration and operational aspects of the AdderView CATx 1000 units are controlled via [on-screen menu](#) displays.

Overall initial configuration

When setting up a new installation, the following stages are recommended:

1 [Enable the general 'Security' option.](#)

With security disabled (default setting), a local or remote user attached to the AdderView CATx 1000 will have full and unrestricted access to all computers and all AdderView CATx 1000 settings. In larger installations, you are strongly recommended to enable security and set up individual user accounts with access privileges.

2 [Create an ADMIN \(administration\) password.](#)

All AdderView CATx 1000 units have a fixed user account that cannot be deleted or renamed, called ADMIN. This user account is the only one that is able to make important system changes. If you intend to use security, then it is important to allocate a password to the ADMIN account.

3 [Create user accounts and allocate access rights.](#)

Use the ADMIN account to add user profiles, passwords and access rights for each of the system users.

4 [Provide names for computers.](#)

When numerous computers are attached, you are strongly advised to provide names for each, to assist with recognition.

5 Configure the required ['Setup Options'](#) and ['Global Preferences'](#)

Use the ADMIN account to determine key AdderView CATx 1000 settings and timing characteristics.

INSTALLATION

CONFIGURATION

OPERATION

FURTHER
INFORMATION

INDEX

Configuration menus

The configuration menus allow you to determine many aspects of the AdderView CATx 1000 capabilities. From here you can:

- Create individual user accounts and determine access rights,
- Provide names for all connected computers to allow quick recognition,
- Set individual and global settings for users,
- Run various functions, such as mouse restore operation,
- Save and load AdderView CATx 1000 configuration settings, and more.

To access the configuration menu

- 1 If the main menu is not already displayed, press and hold **Ctrl** **Alt** and then press **M** using a keyboard attached to a AdderView CATx 1000 user port. The main menu will be displayed:

The screenshot shows the main menu of the ADDERVIEW CATx 1000. It features a table of computer ports and their availability, a user login section, and a list of function keys. Annotations point to various elements:

- Default names for each computer port:** Points to the 'Computer' column in the table.
- Your Login name:** Points to the 'ADMIN' text in the user login field.
- Availability of each computer:** Points to the colored status indicators (green for available, red for unavailable) in the 'Port' column.
- Port numbers:** Points to the numerical values (01-08) in the 'Port' column.
- Connection status:** Points to the 'SHARED USE' text in the status field.
- Assistance for keypress options:** Points to the function key shortcuts (F1-F4) at the bottom.

Computer	Port	Availability
Computer 1	01	Green (available)
Computer 2	02	Red (unavailable)
Computer 3	03	Green (available)
Computer 4	04	Green (available)
Computer 5	05	Red (unavailable)
Computer 6	06	Red (unavailable)
Computer 7	07	Red (unavailable)
Computer 8	08	Red (unavailable)

User: ADMIN | Status: SHARED USE

Function keys: F1-More menus, F3-Find, Esc-Quit, F4-Logout

- 2 Press **F1** To display the Configuration Menu:

The screenshot shows the Configuration Menu with the following options:

- Configuration Menu
- Functions (highlighted)
- User Preferences
- Global Preferences
- Setup Options
- Edit Computer List
- Edit User List
- Edit Autoscan List

Function keys: F1-More menus, Enter-Select, Esc-Quit, Firmware Version 1.01b06

- 3 Use the **↓** and **↑** keys to highlight an option, then press **↵** to select.

Hotkeys

Note: **Ctrl** and **Alt** are the standard hotkeys and can be **altered** to avoid clashes with other devices or software. If you change the hotkeys, remember to use the new ones in place of **Ctrl** and **Alt** when following the instructions in this guide.

Security

Note: If the security option has been enabled, you will be asked for a valid user name and password before the main menu can be displayed.

The screenshot shows the security login screen with the following fields:

- User Name: [input field]
- Password: [input field]
- Esc-Scr Save

IMPORTANT: When supplied, AdderView CATx 1000 units have their security features disabled, which means that any attached users have access to all connected computers and all AdderView CATx 1000 settings. You are strongly recommended to **enable the 'Security' feature** and set an access password for the ADMIN account.



- INSTALLATION
- CONFIGURATION
- OPERATION
- FURTHER INFORMATION
- INDEX

Configuration menus layout

The menu options are arranged as shown here:

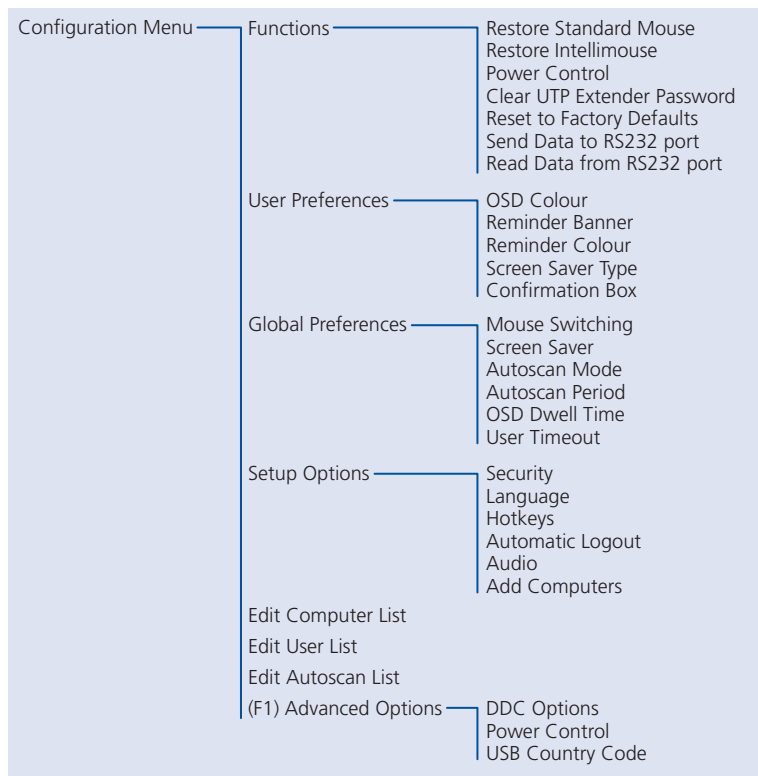

For a description of each option within the Configuration menus, see [Appendix 1](#) for more details.

General security and configuration steps



To enable general security

- 1 Display the [Configuration menu](#).
- 2 Highlight 'Setup Options' and press .
- 3 Highlight 'Security' and press to select 'ENABLED'.
- 4 Now create a new password for the ADMIN user account.

To set an ADMIN password

- 1 Display the [Configuration menu](#).
- 2 Highlight 'Edit User List' and press .
- 3 Highlight 'ADMIN' and press . Press again to accept the name 'ADMIN' without change.
- 4 Enter an appropriate password for the ADMIN user account with regard to the following:
 - The password can be up to 12 characters long.
 - The password can use letters, numerals and/or certain punctuation marks.
 - The password is not case sensitive.
- 5 Press . The 'Edit Access Rights' menu will be displayed. However, as the ADMIN account always has access to all computers, press again to save the new password.

[What to do if the ADMIN password has been forgotten.](#)

To change the hotkeys

AdderView CATx 1000 units use and as their standard hotkeys. These can be changed if they clash with other software or hardware within the installation.

- 1 Display the [Configuration menu](#).
- 2 Highlight 'Setup Options' and press .
- 3 Highlight 'Hotkeys' and press to select the required hotkey combination. The options are: *CRTL+ALT*, *CTRL+SHIFT*, *ALT+SHIFT*, *ALT GR*, *LEFT ALT+RIGHT ALT*, *LEFT CTRL+LEFT ALT* or *RIGHT CTRL+RIGHT ALT*.
- 4 Press to return to the 'Configuration Menu'.

Registering users (edit user list)



To create/edit user accounts

- 1 Display the [Configuration menu](#). *Note: You must be logged-in as the ADMIN user.*
- 2 Highlight 'Edit User List' and press

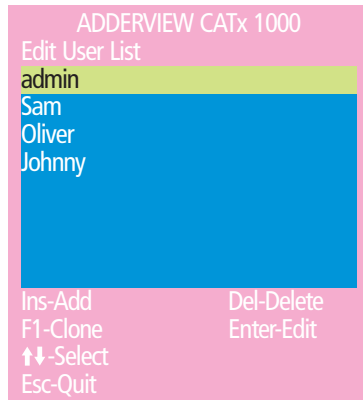

- 3 Either:
 - *Create a new account* - Press , enter a new user name and press , or
 - *Edit an existing account* - Highlight the required user name and press . Edit the name, if appropriate, and/or press .
- 4 Enter or edit the password with regard to the following:
 - The password can be up to 12 characters long.
 - The password can use letters, numerals and/or certain punctuation marks.
 - The password field can remain blank to allow open access to this account.

- 5 Press to display the 'Edit Access Rights' menu.

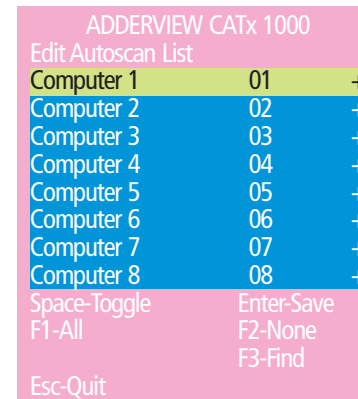

Cross markers indicate which computers will be accessible to the currently selected user. To change the permission state: Highlight a computer and press the space bar.

Here you can determine which of the connected computers can be accessed by the selected user account. Only computers that show the '+' marker to the right of the menu box will be accessible to the user account.

Note: Access rights for user accounts to particular computers can also be controlled from the 'Edit Computer List' menu.

- 6 Select and deselect computers as follows:
 - *Individual computer* - Highlight a computer name, then press to apply, or remove, a '+' marker.
 - *Access to all computers* – Press
 - *Access to no computers* – Press
- 7 When all settings have been made, press to save and exit. Press to return to the 'Configuration Menu'.

Registering computers (edit computer list)



To create/edit computer entries

- 1 Display the [Configuration menu](#). *Note: You must be logged-in as the ADMIN user.*
- 2 Highlight 'Edit Computer List' and press

ADDERVIEW CATx 1000	
Edit Computer List	
Computer 1	01
Computer 2	02
Computer 3	03
Computer 4	04
Computer 5	05
Computer 6	06
Computer 7	12
Computer 8	0803

Ins-Add Del-Delete
F1-Clone Enter-Edit
↑↓-Select F3-Find
Esc-Quit

- 3 Either:
 - *Create a new computer entry* – Press and enter a new name, or
 - *Edit an existing computer entry* – Highlight a computer name and press . Press (Backspace) to delete existing characters and enter the required new name (up to 16 characters).

Note: Avoid creating two names for the same computer port.

- 4 Press and the cursor will move to the computer port column on the right side. Change or enter the port address of the computer as required. See the [Addressing computers in a cascade](#) section for more details.

- 5 When the port address is complete, press . The 'Edit access rights' menu will be displayed.

ADDERVIEW CATx 1000	
Edit access rights	
admin	+
Sam	+
Oliver	+
Johnny	

Space-Toggle Enter-Save
F1-All F2-None
F3-Find
Esc-Quit

Cross markers indicate which users will be granted access to the currently selected computer. To change the permission state: Highlight a user name and press the space bar.

Here you can determine which users should have access to the created/edited computer. Only users that show a '+' marker to the right of the menu box will be granted access to the computer.

Note: Access rights for particular user accounts to computers can also be controlled from the 'Edit User List' menu

- 6 Select and deselect users as follows:
 - *Individual user* - Highlight a user name, then press to apply, or remove, the '+' marker.
 - *Allow access for all users* – Press
 - *Allow no user access (except ADMIN)* – Press
- 6 When all settings have been made, press to save and exit. Press to return to the 'Configuration Menu'.

INSTALLATION
CONFIGURATION
OPERATION
FURTHER INFORMATION
INDEX

Video compensation

The AdderView CATx 1000 units allow a remote user to be extended by a maximum of 300m (980 feet). Such long cable lengths can affect video signals, especially when higher screen resolutions are used. In order to eliminate any video signal degradation, all Adder X100 and X200 extenders provide effective software-based video compensation features.

Remote user video compensation

Video compensation for each remote user is provided by their Adder X100 or X200 modules, not by the AdderView CATx 1000 unit itself. Using the Adder X100/X200 controls you can adjust the picture sharpness and brightness to improve the remote picture quality.

Video compensation is best carried out when viewing high contrast images with vertical edges, such as black lines on a white background. When doing so, if you notice that the screen image is 'fuzzy' or 'dark' then the image controls may not be able to solve this condition.

Note: If the high contrast images exhibit shadows with separate colours, then there may be a skew problem which requires a different image adjustment (provided only by Adder X100AS/R and X200AS/R modules) - see the [Remote user skew adjustment](#) section for details.

To display a suitable high contrast image

The best way to clearly view the effect of sharpness and brightness adjustments is to display a high contrast image, with vertical edges, on the screen.

- Open a word processor, type the capital letter 'H', or 'M' and increase the point size to 72 or higher. For best results, the background should be white and the character should be black.
- A BLACK shadow on the right of the character indicates UNDER compensation.
- A WHITE shadow on the right of the character indicates OVER compensation.

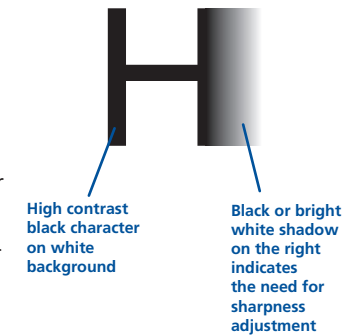

Note: The Word processor method is accurate and quick. However, for the very finest video compensation, use the latest Adder "skew" test pattern program which shows both the skew pattern and a section of mixed size Hs (black on white and white on black).

If the image controls cannot provide a crisp image

If, after adjusting the image controls, one or more screen images remain fuzzy or have coloured shadows you may need to use the Skew adjustment feature. Please see [Remote user skew adjustment](#) for details (Adder X100AS/R or X200AS/R modules only).

continued

To apply remote user video compensation

- 1 On the remote user keyboard (connected to an Adder X100/X200 extender), simultaneously, press the hotkeys (by default, **Ctrl** and **Shift**) along with **Enter** to enter configuration mode.

The three keyboard indicators ('Num Lock', 'Caps Lock' and 'Scroll Lock') will now begin to flash in sequence. The speed of the sequence indicates the level of the sharpness adjustment currently applied: the slower the rate, the lower the level of sharpness being applied.

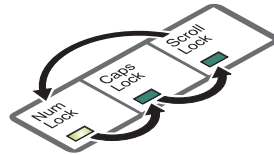

- 2 While viewing the displayed screen image, use the following keys to adjust the controls:

Sharpness: **↑** **↓** for fine adjustment, **Page Up** **Page Down** for coarse adjustment.

There are 255 sharpness levels (one coarse step jumps 10 levels).

To autoselect sharpness (X100 modules only): Press **F2** **Enter** to make the module calculate and apply an automatic compensation level - you can use this as a starting point for your fine tuning.

Note: If the monitor goes blank and switches off (due to oversetting the sharpness adjustment) press the Home key to restore.

Brightness: **←** **→** for adjustment. There are 255 brightness levels.

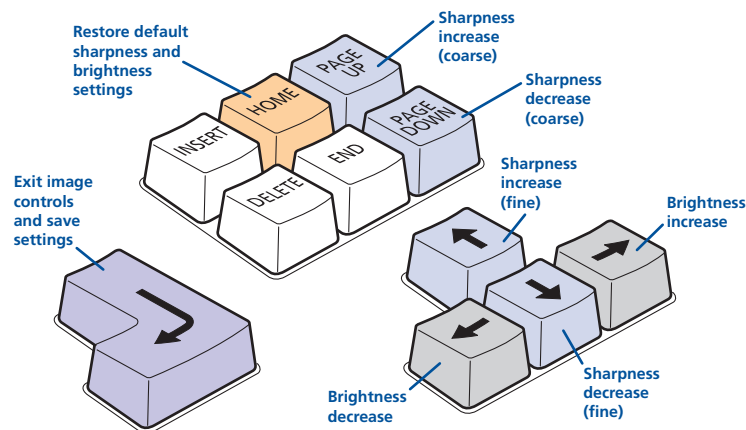

- 3 When no shadows are visible and the displayed images have crisp edges, press **Enter** to exit configuration mode and permanently save all settings. The new compensation settings will be stored, even when power is removed or if a complete reset is initiated. These settings should not require further changes unless the cabling arrangements are altered.

Remote user skew adjustment

The category 5, 5e and 6 cabling supported by the AdderView CATx 1000 consists of four pairs of wires per cable. Three of these pairs are used to convey red, green and blue video signals to the remote video monitor. Due to the slight difference in twist rate between these three pairs, the red, green and blue video signals may not arrive at precisely the same time. This is visible as separate colour shadows on high contrast screen images and is particularly apparent when using higher screen resolutions and some types of category 5e cables.

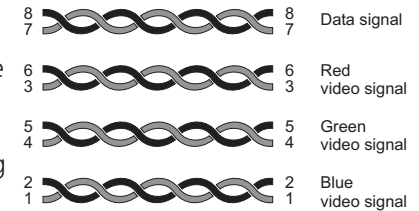
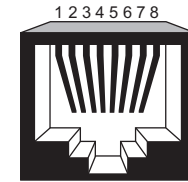

To alleviate this situation, the Adder X100AS/R and X200AS/R modules provide internal skew adjustment that can help to rectify the situation. The skew adjustment works by delaying or advancing the timing of any of the red, green or blue colour signals so that they are all delivered to

the monitor at precisely the same time. For best results, the "skew" program supplied on the disk or downloadable from www.adder.com or www.adder.info is the most accurate way of setting skew as the red, green and blue lines are rendered exactly on the screen as single pixel wide lines. The skew.bmp test pattern can also be used but it is less accurate. Alternatively, you can create your own skew pattern using a standard image creation package, as detailed on the next page.

continued

To use skew adjustment

- 1 Display a skew pattern on the appropriate computer. You can either use the supplied skew pattern or create your own:

Using the supplied skew pattern

- i Insert the supplied Adder Installation CD-ROM into the CD player of the computer.

- ii Within Windows, use the *My Computer* option (usually available as a desktop icon or within the Start menu) to view the contents of the CD-ROM. Double-click the **Skew** entry to display the standard test pattern. If necessary, maximise the application window so that the image fills the screen.

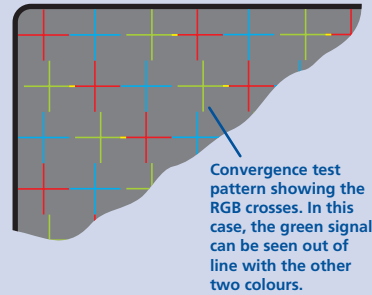

The screen will show a series of fine red, green and blue crosses which should all be in line, vertically and horizontally. Skew affects the horizontal placement of the colours and using this pattern it is much easier to discover which, if any, colours are being adversely affected by the cable link.

Creating a skew test pattern

- i Run any image creation/editing application, such as the Paint program supplied with Windows.
- ii Using the image application create three stacked horizontal rectangles (one red, one green and one blue) that fill the width of the screen.
- iii Draw a vertical black line down across the coloured bars and then repeat this vertical line at intervals along the width of the coloured bars. These lines create breaks across the colours and give you more opportunities to view the horizontal position of each colour relative to the others.

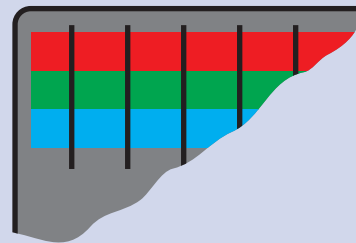

- 2 On the remote user keyboard (connected to an Adder X100AS/R or X200AS/R extender), simultaneously, press the hotkeys (by default, **Ctrl** and **Shift**) along with **F10** to enter configuration mode.

The three keyboard indicators ('Num Lock', 'Caps Lock' and 'Scroll Lock') will now begin to flash in sequence.

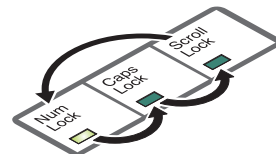

- 3 As appropriate, press either the R, G or B keyboard keys to select the appropriate colour channel. Corresponding keyboard indicators will flash rapidly to show which channel is currently selected for adjustment: Num Lock for Red, Caps Lock for Green and Scroll Lock for Blue.

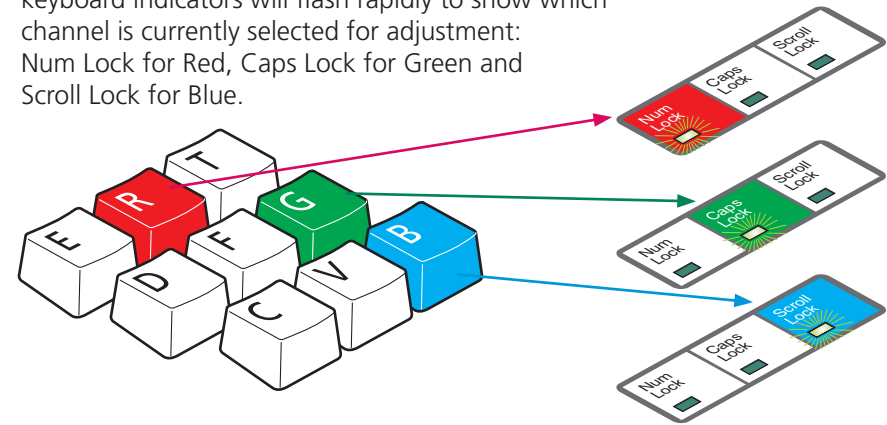

- 4 Press the **Left Arrow** and **Right Arrow** keys to retard or advance the timing of the selected colour channel respectively. On screen you will see a change in the position of the selected colour crosses (or colour bars) in relation to the other two.

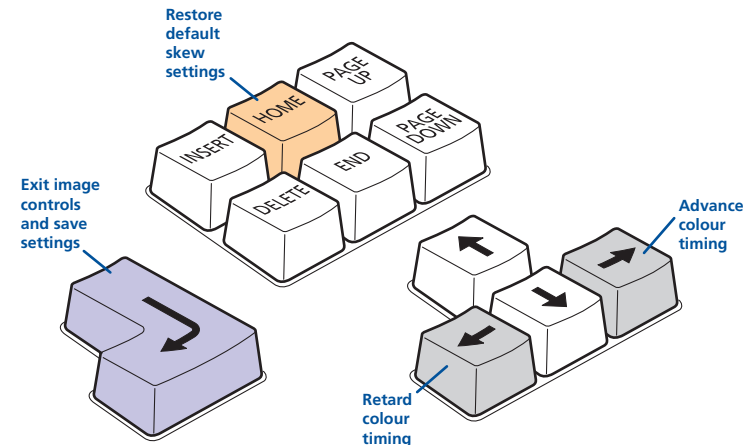

- 5 When the selected colour crosses (or colour bars) are correctly positioned, press **F10** to exit that colour channel. The keyboard indicators will return to flashing in sequence.
- 6 If required, repeat steps 3 to 5 to select and adjust any colour channel until the vertical lines of the red, green and blue crosses are all aligned.
- 7 When all colours are correctly aligned on all video channels, press **F10** to exit configuration mode and permanently save all settings.

Note: Once you have made the skew adjustments, it may be necessary to re-adjust the image controls to attain optimum screen images.

Autoscanning

The AdderView CATx 1000 provides an autoscan mode that switches between the connected computers in sequence. This mode is useful to allow users and administrators to sample activity among the connected machines. Three scanning modes are provided:

- *Scan list* – Only computers declared within an autoscan list will be viewed. Computers connected to cascaded switches can be included in the autoscan list.
- *Active PCs* – Only computer ports where an active computer is detected will be viewed. This mode avoids blank screens from being displayed and helps to prevent the viewing monitor from entering a power-down state on every scan cycle. Computers connected to cascaded switches will not be viewed in this mode.
- *All PCs* – This mode visits, in turn, each computer that is connected directly to the AdderView CATx 1000. This mode should be used with care due to the reasons given in the warning below. Computers connected to cascaded switches will not be viewed in this mode.

The scanning mode is a global setting and hence will be the one viewed by any user who selects **Ctrl** **Alt** **A** on their keyboard. Note, however, that users will only see the scanned computers to which they have access rights.

WARNING: Many monitors are fitted with automatic power saving relays that switch off after a few seconds when connected to an inactive computer. If you are using such a monitor, do not set the AdderView CATx 1000 to the scan 'ALL PCs' mode. Continual switching on and off of the monitor's relay will eventually damage the monitor. If using such a monitor in conjunction with the 'Scan List' option, ensure that all selected computers are active.

There are up to three steps that need to be configured to use autoscanning:

- *Select the autoscan mode:* Scan List, Active PCs or All PCs.
- *Select the autoscan period.* This is the time that is spent viewing each computer. This step also enables and disables the autoscan feature.
- *Define the autoscan list.* This step is only required when the Scan List option is selected and allows you to select which computers will be scanned.

To select an autoscan mode

- 1 Display the [Configuration menu](#). *Note: You must be logged-in as the ADMIN user.*
- 2 Highlight 'Global Preferences' and press **↓**.
- 3 Highlight 'Autoscan Mode' and press **Space** until the required option is displayed: SCAN LIST, ACTIVE PCs or ALL PCs.

To select an autoscan period

- 1 Display the [Configuration menu](#). *Note: You must be logged-in as the ADMIN user.*
- 2 Highlight 'Global Preferences' and press **↓**.
- 3 Highlight 'Autoscan Period' and press **Space** until the required time to view each computer is displayed, ranging from 2 seconds to 5 minutes.

To define an autoscan list

Note: This stage is required only when the 'Scan List' autoscan mode is selected.

- 1 Display the [Configuration menu](#). *Note: You must be logged-in as the ADMIN user.*
- 2 Highlight 'Edit Autoscan List' and press **↓**. A list of all connected computers will be displayed. Only computers that show a '+' marker to the right of the menu box will be autoscanned.
- 3 Select and deselect computers to scan as follows:
 - Individual computer - Highlight a computer name, then press **Space** to apply, or remove, the '+' marker.
 - Mark all computers for scanning – Press **F1**.
 - Unmark all computers – Press **F2**.
- 4 When all settings have been made, press **↓** to save and exit. Press **Esc** to return to the 'Configuration Menu'.

To view autoscan

- At one of the user ports, press **Ctrl** **Alt** **A**.

*Note: **Ctrl** and **Alt** are the standard hotkeys and can be [altered](#) to avoid clashes with other devices or software. If you change the hotkeys, remember to use the new ones in place of **Ctrl** and **Alt** when following these instructions.*



Saving and restoring configuration settings

The AdderView CATx 1000 can store up to 256 computer names and 5 sets of user access rights in addition to the ADMIN user account. Particularly in cascaded configurations, manually re-entering all computer names, port numbers and access rights can be a lengthy process. Therefore, the AdderView CATx 1000 provides a method to save and, if required, restore configuration settings using its serial port. Further to this, the saved file can be opened and edited within a text editor or spreadsheet and then restored back to the AdderView CATx 1000 – a useful way to make multiple setup changes.

Note: You must be logged-in as the ADMIN user for this procedure.

Preparations for configuration save/load

- Download the Adder Data Transfer utility - contact Adder Technical Support for details.
- Connect the serial port on the rear panel of the AdderView CATx 1000, labelled **OPTIONS**, to a serial port on your computer using the optional serial flash upgrade cable. See [Appendix 2](#) for pin-out specifications.

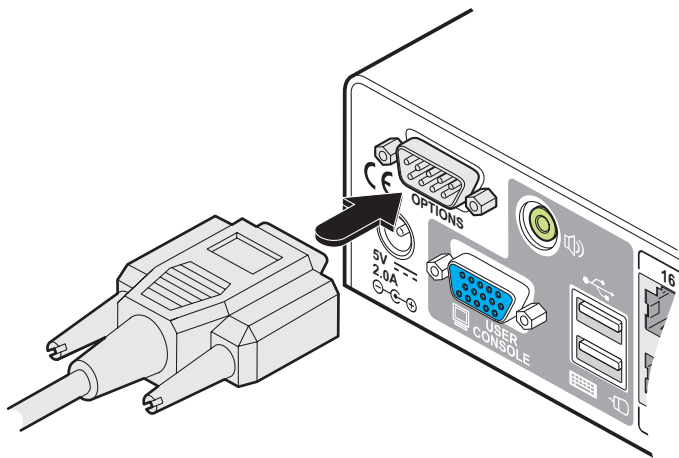

To transfer configuration settings

- 1 Run the Adder Data Transfer utility on the computer that is connected to the AdderView CATx 1000 Options serial port. The utility has a single window:

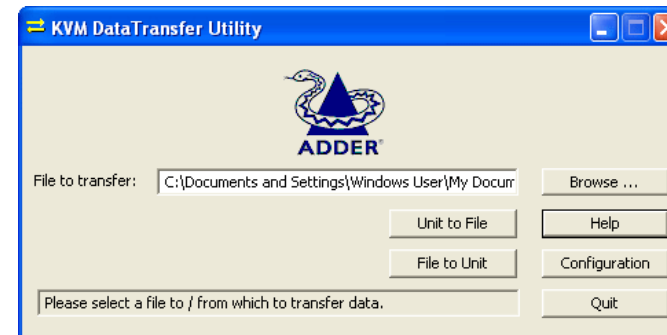

- 2 Click the Configuration button and ensure that the appropriate serial port of the computer is selected.
- 3 Click the Browse... button to locate or create a text file that will either provide or receive the AdderView CATx 1000 data.
- 4 Choose the direction of data flow:
 - Click the Unit to File button to download the existing AdderView CATx 1000 configuration to the selected text file, or
 - Click the File to Unit button to upload the contents of the file to the AdderView CATx 1000 unit.A pop-up dialog box will request you to set-up the unit to either send or receive RS232 data.
- 5 Using the local port of the AdderView CATx 1000 unit, display the [Configuration menu](#). *Note: You must be logged-in as the ADMIN user.*
- 6 Select the 'Functions' option.
- 7 Select either 'Send Data to RS232 port' (if you chose the Unit to File button) or 'Read Data from RS232 port' (if you chose the File to Unit button).
- 8 On the computer, click the OK button of the pop-up dialog box to begin downloading or uploading. The process will end automatically when all data have been transferred.

continued



What to do if the ADMIN password has been forgotten

If the ADMIN password becomes mislaid or forgotten, you will not be able to access the AdderView CATx 1000 to add or edit users and computer names. This situation may be resolved by performing a complete reset to return the AdderView CATx 1000.

***IMPORTANT:** A complete reset erases all the user names and computer names that you have setup.*

To clear a password (and restore factory default settings)

- 1 Remove power from the AdderView CATx 1000 unit.
- 2 Connect the AdderView CATx 1000 unit to a computer in the same manner as you would to carry out a flash upgrade - see [Performing flash upgrades](#).
- 3 Press and hold the reset button on the front panel (requires paper clip or similar).
- 4 Apply power and after 3 seconds release the reset button. The 'UPG' LED should now be illuminated.
- 5 Set the computer serial settings to the following: 57600, n, 8, 1
- 6 Using 'TeraTerm' (recommended) or an alternative terminal program, send "CLEAR<cr>" - in UPPER CASE from the keyboard. The AdderView CATx 1000 unit should respond with "OK".
- 7 The password is now clear and all factory default settings restored.

Power switching configuration



Power switch configuration comprises two main steps:

- Configure the POWER CONTROL serial port to the same speed as used by the power switch box(es) via the [configuration menu](#).
- Configure power ON and OFF strings for each relevant host computer.



For each power port there needs to be a valid 'Power ON string' and similarly an appropriate 'Power OFF string'. In each case, the strings are a short sequence of characters that combine a port address and a power on or off value.

If a particular computer has more than one power input (and thus requires an equivalent number of power ports to control them), collections of strings can be combined to switch all of the required ports together as a group.



To configure the power sequences for each host computer

- 1 Select the on-screen menu in one of two ways:
 - By simultaneously pressing and then releasing   , or
 - By pressing the middle and right buttons of a three button mouse.

Note: The mouse switching option is usable only if the 'Mouse Switching' option is enabled. See [Global preferences](#) for more details.

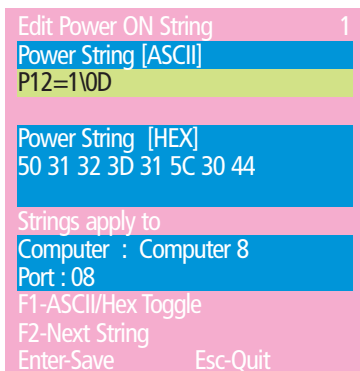
If the login screen is displayed, enter a valid password.
- 2 Press  to select 'More menus'.
- 3 Highlight the 'Functions' option and press  to select.
- 4 Highlight the 'Power Control' option and press  to select.
- 5 As appropriate, highlight either the 'Edit Power ON String' or the 'Edit Power OFF String' options to display a screen similar to the one shown below:



- 6 Enter the required codes either within the upper ASCII section or the middle HEX section (use  to change between them). The required codes are explained in 'Power control sequences' opposite.
- 7 Press  to store the details and exit from the screen.

Power control sequences

Note: The settings given below are for the EPS-S8 power switch - other power switches may require different settings. Please refer to your power switch documentation for details about codes required by other power switches.

The structure of each power sequence (OFF and ON) is as follows:

$Pxy=z\0D$

Where:

- x** is the switch box number,
- y** is the power port number,
- z** is '0' for OFF or '1' for ON, and
- \0D** represents Enter (or Carriage return).

Example 1

To switch ON port 5 of switch box 2, the code would be as follows:

- Power sequence: P25=1\0D

Example 2

To switch OFF port 8 of switch box 3, the code would be as follows:

- Power sequence: P38=0\0D

For details about operating this feature, see [Power switching \(via configuration menu\)](#) within the Operation chapter.

To control two or more ports simultaneously

You can control up to four power ports using a single sequence. This is done using the same command structure as shown above, plus a delay command, for each port. Immediately following a port command, insert the characters '*' before the next port command, and so on up to four ports. For instance, to switch on ports 1 and 2 in the first power switch, the command line would be:

P11=1\0DX*P12=1\0D



- INSTALLATION
- CONFIGURATION
- OPERATION
- FURTHER INFORMATION
- INDEX

Performing upgrades

The AdderView CATx 1000 units are fully upgradeable via flash upgrades, as are the individual Computer Access Modules that are used to link all host computers. Such upgrades require a Windows-based computer system to be linked via the OPTIONS port.

Upgrading AdderView CATx 1000 units and CAMs

The KVM Firmware Uploader utility is available from the Adder Technology website (www.adder.com) and allows you to check the current revision of the AdderView CATx 1000 unit firmware as well as every Computer Access Module connected to it.

Items required to use the upgrade utility

- Optional serial upgrade cable (see [Appendix 2](#) for pin-out specifications).
- A Windows-based upgrade computer with an RS232 serial port.
- The latest version of the KVM Firmware Uploader and firmware files for the AdderView CATx 1000 - available from the *Technical Support > Updates* section of the Adder Technology website (www.adder.com).

To use the KVM Firmware Uploader utility

1 - Obtain and run the KVM Firmware Uploader.

Download the latest AdderView CATx 1000 KVM Firmware Uploader from the Adder Technology website and install it on a Windows-based upgrade computer that will be connected to the AdderView CATx 1000 unit. The files are supplied as a compressed ZIP file. Decompress the ZIP file with an appropriate tool such as WinZip (www.winzip.com) and copy all contained files to the same folder on the upgrade computer.

2 - Power off the AdderView CATx 1000

Remove the power supply plug from the rear panel of the unit.

3 - Connect the upgrade computer to the AdderView CATx 1000

Connect the upgrade computer to the OPTIONS port on the rear panel of the AdderView CATx 1000 unit using the supplied upgrade cable.

Set the configuration of the computer's serial port to: 19200 baud, 8 data bits, no parity, 1 stop bit.

4 - Power on the AdderView CATx 1000 and invoke upgrade mode

Use a straightened out paper clip to press and hold the reset button (small hole adjacent to the front panel connector). Reconnect power and wait for three seconds before releasing.

The UPG indicator should illuminate to show that the AdderView CATx 1000 is ready to be upgraded.

5 - Run the KVM Firmware Uploader utility

From that folder, select the KVMUploader icon to run the upgrade utility. The KVM Firmware Uploader dialog will be displayed:

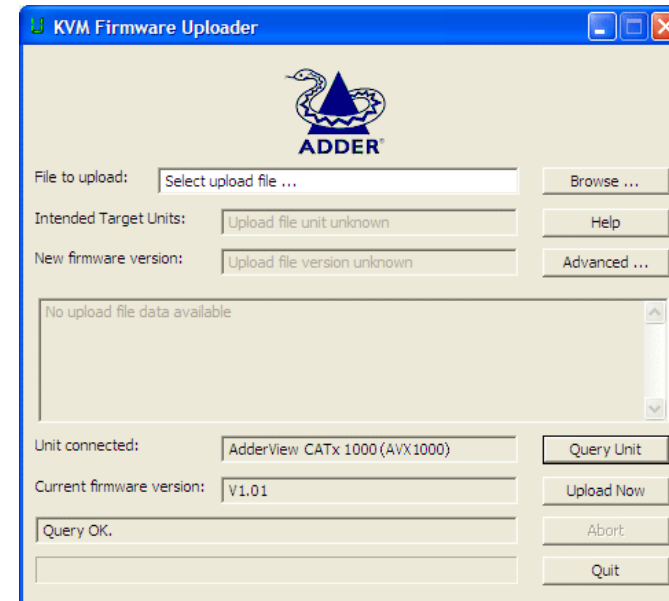

6 - Query the AdderView CATx 1000 unit

Click the *Query Unit* button to confirm that communication is possible with the AdderView CATx 1000 and to establish the firmware details of the main unit and all connected CAMs.

Note: The computer to which each CAM is connected must be powered before the respective CAM can be accessed.

Note: AdderView CATx 1000 units in lower levels of cascade links (and their respective CAMs) cannot be queried or upgraded while remaining in the cascade arrangement.

If the application cannot contact the AdderView CATx 1000, re-check the connection cable and click the *Advanced...* button to check that the correct serial port is being used. Change the serial port within the *Advanced* section, if necessary.

continued



The results of the unit query will be displayed in the Device/Dongle Selection dialog:

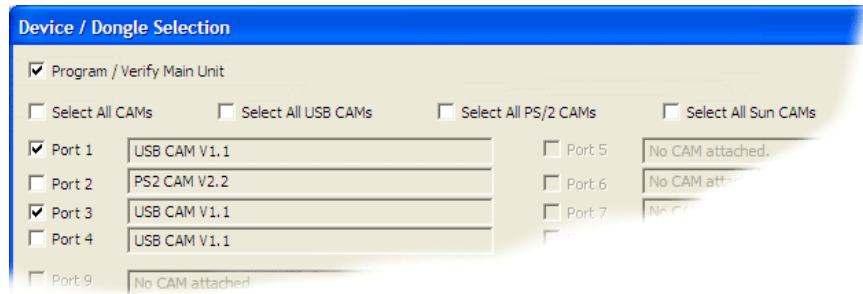

The type and firmware revision of each discovered CAM will be displayed alongside the port number to which it is connected.

7 - Select the items to be upgraded

Using the Device/Dongle Selection dialog you can determine which items should receive a firmware upgrade:

- Use the *Program / Verify Main Unit* option to include or exclude the AdderView CATx 1000 unit itself.
- Use the *Select All CAMs* option to upgrade every discovered CAM.
- Use the *Select All USB / PS2 / Sun CAMs* options to upgrade only CAMs of a certain type.
- Use the individual port options to select particular CAM devices to upgrade.

When the required options have been selected, click OK.

Note: Approximate upgrade times are: AdderView CATx 1000 unit = 4½ minutes; each selected CAM = 20 seconds.

8 - Select the upgrade file to be used

From the main KVM Firmware Uploader dialog, click the *Browse...* button and select the upgrade file:

AV1000_x.xx.txt

where x.xx is the firmware version.

The upgrade file details will be displayed within the dialog.

IMPORTANT: Check that the 'Intended Target Units' field matches the 'Unit Connected' field. If these fields do not match then you may have an incorrect upgrade file, check with Adder Technology Ltd before proceeding. Check also that the 'New firmware version' is greater than the 'Current firmware version'.

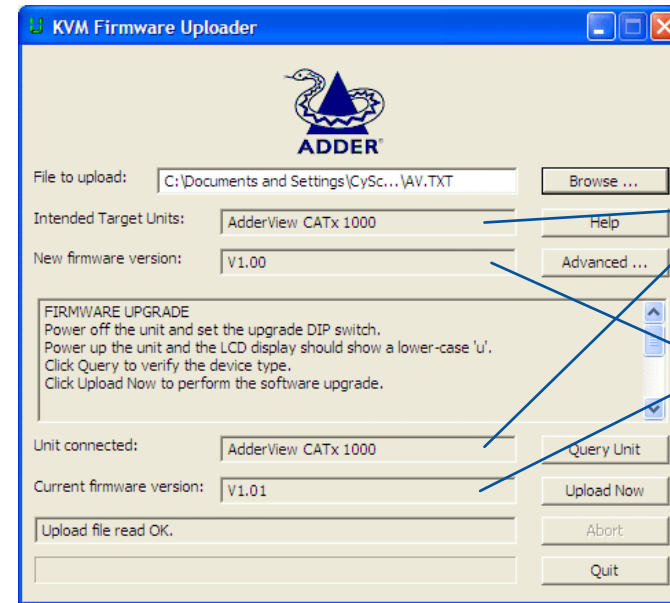

Check that the 'Intended Target Units' field matches the 'Unit Connected' field.

Check also that the 'New firmware version' is greater than the 'Current firmware version'.

9 - Commence the upgrade

To begin the upgrade process, click the *Upload Now* button. The progress will be shown within the dialog. Should you decide not to continue with the upload at any stage, click the *Abort* button; response to this is usually immediate, however, during an erase command, the upload will not be aborted until the erase is complete (this may take a few seconds).

10 - Cycle the power

Disconnect the power. When the power is re-applied the AdderView CATx 1000 will operate using the new firmware.

Issues to consider when performing flash upgrades

The upgrade program rewrites the AdderView CATx 1000 firmware code. If the upgrade process is interrupted then the AdderView CATx 1000 will have invalid code and will not be able to operate. It is therefore good practice to ensure that the upgrade process is always fully completed. A partial or failed upgrade may be rectified by performing another upgrade. If the upgrade process is interrupted accidentally then you should press and release the front panel reset button without re-powering the unit. Running faulty or partially upgraded code may have unpredictable results and may damage your AdderView CATx 1000 or computing equipment.

WARNING: Running faulty or partially upgraded code may have unpredictable results and may damage your AdderView CATx 1000 or computing equipment.

Operation



Local and remote user access

Local users (directly connected) and remote users (via an Adder X100/X200 extender) gain access to the AdderView CATx 1000 unit in exactly the same way.

To gain access as a local or remote user:

- 1 From a local or remote keyboard, press any key to display the login prompt:



If the above login prompt is not displayed, you are either already logged in to the AdderView CATx 1000 unit, or the security features have not been implemented. In such cases see 'To view this menu at any time' below.

- 2 Enter your username and password. Providing you have the correct permissions, the screen will display the main menu, showing you a list of computers for which you have permission to access:

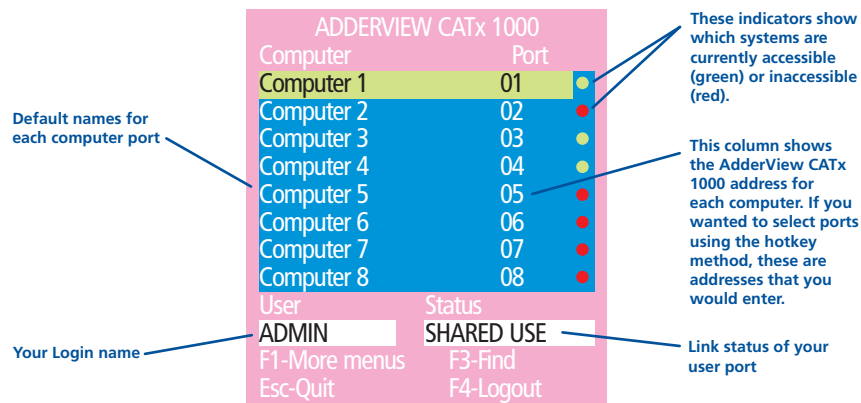

To view this menu at any time: Press and hold the hotkeys (usually **Ctrl** and **Alt**), then press **M** and finally release all three keys.

Note: The **Ctrl** and **Alt** keys when pressed in combination are called 'hotkeys' and they signal to the AdderView CATx 1000 that you wish to control it, rather than the host computer. However, if these particular hotkeys clash with another device or program, then your administrator may change them to a different combination. If the **Ctrl** **Alt** **M** combination fails to work, then please contact your system administrator for details.

Selecting a computer

There are three main ways for local and remote users to select a specific computer channel:

- Using hotkeys (as described below) – this is a good method if you continually access a small number of computers.
- [Using the on-screen menu](#) – this is the best method when there are many connected computers.
- [Using mouse buttons](#) – this is a good method for cycling between a small number of computers.

For all methods (if the [confirmation box option](#) is enabled), when the required port is selected, a pop up message will be displayed to confirm the computer name or number, and its status. Alternatively, an error message explaining why a connection is not possible (press **Esc** to cancel the latter type of message).

To select a computer using hotkeys

- 1 Simultaneously press and hold **Ctrl** and **Alt**.

Note: The **Ctrl** and **Alt** keys when pressed in combination are called 'hotkeys' and they signal to the AdderView CATx 1000 that you wish to control it, rather than the computer. However, if these particular hotkeys clash with another device or program, then your administrator may change them to a different combination. If the **Ctrl** **Alt** combination fails to work, then please contact the system administrator for details.

- 2 While still holding **Ctrl** and **Alt**, press the first numeral of the required port address, then:

- If the port address is a single character, release all of the keys.
- If the port address is two or more characters, release the first numeral key and press the second – repeat this procedure until all of the port address numerals have been entered, then release **Ctrl** and **Alt**.

Note: The numbers on your keyboard's numeric keypad are not valid, use only the numeral keys above the QWERTY section.

Note: If your user port does not have authorisation to view the selected port then an 'Insufficient user rights' messages will be displayed.

continued

Standard hotkeys

The range of hotkey combinations are as follows:

*Note: If your hotkeys have been changed, substitute them for **Ctrl** and **Alt** in the examples given here.*

Ctrl **Alt** **1**

Selects port 1

Ctrl **Alt** **2**

Selects port 2

-
-

-
-

Ctrl **Alt** **1** then **0**

Selects port 10

*Note: When entering multiple digit addresses as above or for even longer cascaded computers, keep **Ctrl** and **Alt** pressed down until all other numbers have been entered.*

Ctrl **Alt** **Tab**

Selects the next available port

Ctrl **Alt** **A**

Selects autoscan mode where each (authorised) port is displayed for a period determined by the administrator. To cancel autoscan mode, simply select any fixed channel using any of the suggested methods.

Ctrl **Alt** **0**

Switches off the video signal – this will cause a power saving monitor to enter its standby mode. To awaken the monitor, simply select any fixed channel using any of the suggested methods.

Ctrl **Alt** **L**

Logs out the current user (if security is enabled) or selects port 0 to disable the video signal (if security is disabled).

Ctrl **Alt** & **↓**, **↑**, **←** or **→**

Moves the currently displayed on-screen menu around the screen.

To select a computer using the on-screen menu

1 Select the on-screen menu in one of two ways:

- By simultaneously pressing and then releasing **Ctrl** **Alt** **M**, or
- By pressing the middle and right buttons of a three button mouse.

Note: The mouse switching option is usable only if the 'Mouse Switching' option is enabled. See [Global preferences](#) for more details.

At this point, depending on the security settings and the current log in situation, one of two things will be displayed, either the login screen, or the Selection menu:

ADDERVIEW CATx 1000	
Computer	Port
Computer 1	01
Computer 2	02
Computer 3	03
Computer 4	04
Computer 5	05
Computer 6	06
Computer 7	07
Computer 8	08
User	Status
ADMIN	SHARED USE
F1-More menus	F3-Find
Esc-Quit	F4-Logout

The Selection Menu – here you can select computers by name.

2 Use the **↓** and **↑** keys (or the scroll wheel of an IntelliMouse) to highlight the required computer name. Alternatively (for large configurations), press **F3** to perform an alphabetical search for a particular port name.

Note: If security has been enabled then only computers to which the current user port has permission will be displayed.

3 Press **↓** to select the highlighted port.

To select a computer using mouse buttons

Note: This procedure works only with three-button or IntelliMouse devices and only if the 'Mouse Switching' option has been enabled by your administrator.

- 1 Hold down the middle button (or scroll wheel) of the mouse.
- 2 Click the left mouse button to select the next computer port. When the correct port is reached, release the middle button.

Note: If security has been enabled then only computers to which you have permission will be displayed.

To select a computer using mouse buttons – Advanced method

- 1 Select the on-screen menu by pressing the middle and right buttons of a three button mouse.
- 2 Use the scroll wheel to highlight the required computer port.
- 3 Then, select either:
 - *Shared Use* - press the left mouse button - This *standard* method allows other users to view the same computer port. Control of the port is given to one user at a time, on a first-come, first-served basis and is relinquished after a certain period of inactivity.
 - *Escape without selecting a port* – press the right mouse button.

User arbitration - simultaneous local and remote users

During operation, if both the local and remote user consoles are both connected and being used, the connected video monitors will both continuously receive the output from the selected host system. Control of the selected host system (and switching operations) is arbitrated by the AdderView CATx 1000 on a first come, first served basis. In the idle state, control is available to both users and their keyboard indicators both show the current Num Lock, etc. conditions of the host system.

At the moment that a key is pressed or a mouse is moved, the keyboard and mouse of the other user are temporarily locked-out (the video images remain). The keyboard indicators of the locked-out user then begin to flash to confirm their status ⇔

After a period of inactivity (determined by the User Timeout option in Global Preferences) from the user currently in control, the modules return to their idle condition and re-instate the keyboard indicators of the locked-out user.

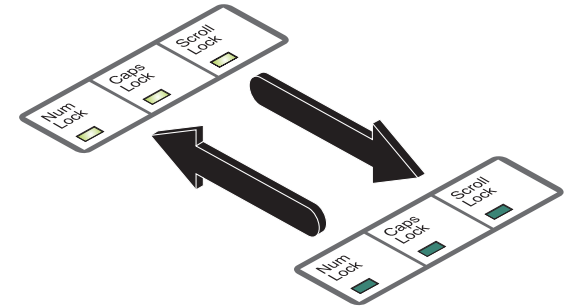



Logging in and out

The AdderView CATx 1000 features a straightforward security system that helps to prevent unauthorised access to some, or all connected computers.

If the security option has been selected by your administrator then you will be asked to enter a *User Name* and *Password* when you first access a user port. When you have finished using the computer, it is then good practice to logout, forcing any other users to authenticate themselves prior to use.

Note: If the security option has not been enabled then no login is required.

To log in to the AdderView CATx 1000

- 1 If it is not already displayed, move the mouse or press any key to display the log in screen.
- 2 Enter your designated *User Name* and press .
- 3 Enter your designated *Password* and press . If both entries are correct then the selected port will be displayed.



Note: If either the User Name or Password are incorrect, the entries will be cleared to allow another attempt.



To log out from the AdderView CATx 1000

Either:

- Press   and  at any time to log out.

or

- 1 Select the on-screen menu in one of two ways:
 - By simultaneously pressing and then releasing   .

Note: The  and  hotkeys may have been changed. If the combination fails to work, then please contact the system administrator for details, or

 - By pressing the middle and right buttons of a three button mouse.
- 2 Press . You will be logged out and the login window will be re-displayed.

Selecting cascaded computers

The AdderView CATx 1000 is not limited to sharing just eight or sixteen computers. By joining numerous AdderView CATx 1000 products together in a tree-like or [cascade](#) arrangement, it is possible for each user port to view many more computers. Although you can use exactly the same selection methods to choose any computer, you are strongly recommended to use the on screen menu method for the following reasons:









- The [on screen menu](#) – this method displays the names of each computer in alphabetical order and also allows you to search for them by name, press  – a useful feature in a long list. This really is the best way to access a large number of computers.
- The [mouse method](#) – this method is fine for small numbers of computers but can take too long to reach the required computer in an extensive configuration.
- The [hotkey method](#) – depending on their position within the connection structure, each computer can have an address up to four digits long which can be difficult to remember and laborious to type.



The confirmation box

The AdderView CATx 1000 provides the option of a confirmation box that is displayed on screen for three seconds after a computer is selected. The confirmation box indicates the current user port and your user name, the selected computer and the connection status. You can enable or disable the confirmation box, as required.

To enable/disable the confirmation box









- 1 Select the on-screen menu in one of two ways:
 - By simultaneously pressing and then releasing   , or
 - By pressing the middle and right buttons of a three button mouse.If you are not already [logged in](#), do so now.
- 2 Press  to select 'More menus'.
- 3 Highlight the 'User Preferences' option and press  to select.
- 4 Highlight the 'Confirmation Box' option and press  to select 'ENABLED' or 'DISABLED', as required.
- 5 Press  to save the settings. Press  twice more to return to the computer port and view your changes.

The reminder banner









As many computer screen layouts can appear very similar, the AdderView CATx 1000 provides a reminder banner option that indicates which computer port you are currently viewing. The banner is usually displayed at the top of the screen, using white lettering and transparent background. You can:

- Move the banner
- Change the banner colours, and/or
- Disable the banner

To move the reminder banner

- 1 While viewing a computer port, press and hold  and .
Note: The  and  hotkeys may have been changed. If the combination fails to work, then please contact the system administrator for details.
- 2 Press the , ,  and  keys to move the banner to the required position.

To change banner colours or disable the banner



- 1 Select the on-screen menu in one of two ways:
 - By simultaneously pressing and then releasing   , or
 - By pressing the middle and right buttons of a three button mouse.If you are not already [logged in](#), do so now.
- 2 Press  to select 'More menus'.
- 3 Highlight the 'User Preferences' option and press  to select.
- 4 Select the required option:
 - To disable the banner – highlight 'Reminder Banner' and press  until 'DISABLED' is shown.
 - To change colours – highlight 'Reminder Colour' and press  until the desired colour combination is displayed.
- 5 Press  to save the settings. Press  twice more to return to the computer port and view your changes.



Power switching (via configuration menu)

When used in conjunction with optional power switch boxes, the AdderView CATx 1000 allows you complete remote control over the connected computers. The primary function of the power switching option is to remotely power down and reset computers that are failing to respond.

To switch a computer on or off

- 1 Select the on-screen menu in one of two ways:
 - By simultaneously pressing and then releasing   , or
 - By pressing the middle and right buttons of a three button mouse.

If you are not already [logged in](#), do so now.

- 2 Switch to the computer port that needs to be switched on or off.



Note: If the computer is still responding, try to shut it down normally before attempting a power switch operation.

- 3 Display again the on screen menu and press  to select 'More menus'.

- 4 The 'Functions' option should be highlighted, press .

- 5 Highlight 'Power Control' and press .

- 6 Highlight either 'Switch Computer ON' or 'Switch Computer OFF' as necessary and press . A warning message with two options will be displayed.

- 7 Press  to confirm or  to confirm and exit. The latter option clears the menu so that, if required, you can be ready to enter any escape sequences that are needed by the computer (to access its BIOS setup area), during the bootup sequence.

User preferences and functions

In addition to customising the reminder banner as described earlier, you can also:

- Change the colour of the on screen menu,
- Select the screen saver style,
- Restore mouse operation, or
- Perform power control functions.

All of these options are discussed within [Appendix 1](#).



Further information



This chapter contains a variety of information, including the following:

- Getting assistance - see right
- Appendices
 - Appendix 1 - [Configuration menus](#)
 - Appendix 2 - [Cable specifications](#)
- [Safety information](#)
- [Warranty](#)
- [Radio frequency energy statements](#)

Getting assistance

If you are still experiencing problems after checking the list of solutions in the Troubleshooting section then we provide a number of other solutions:

- Adder Technology website – www.adder.com
Check the Support section of our website for the latest solutions and driver files.
- Email – support@adder.com
- Fax
 - in the UK: **01954 780081**
 - in the US: **+1 888 275 1117**
- Phone
 - in the UK: **01954 780044**
 - in the US: **+1 888 932 3337**

INSTALLATION

CONFIGURATION

OPERATION

FURTHER
INFORMATION

INDEX

Appendix 1 – Configuration menus

The AdderView CATx 1000 configuration menus allow a range of settings to be made both to the installation as a whole and to parts of the system accessed by each user.

To access the configuration menus

- 1 Select the on-screen main menu in one of two ways:
 - By simultaneously pressing and then releasing **Ctrl** **Alt** **M**, or
 - By pressing the middle and right buttons of a three button mouse.

If you are not already logged in, do so now. [What to do if the ADMIN password has been forgotten.](#)

- 2 Press **F1** to select 'More menus'.
- 3 Use the following keys:
 - **↑** and **↓** to highlight required options.
 - **Space** to change option values.
 - **Esc** to quit and save the changes.

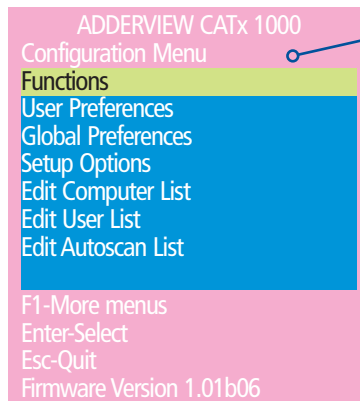

The following items and menus are available in the Configuration menu:

- [Functions](#)
- [User Preferences](#)
- [Global Preferences](#)
- [Setup Options](#)
- [Edit Computer List](#)
- [Edit User List](#)
- [Edit Autoscan List](#)
- [Advanced Options](#) (F1-More menus)

The full set of options are only available to the Admin user. All other users will see a subset of these.



INSTALLATION

CONFIGURATION

OPERATION

FURTHER INFORMATION

INDEX

Functions

The Functions menu contains a collection of procedures that affect various aspects of AdderView CATx 1000 operation. Only the Admin user is granted access to all functions, other users are offered only the following options:

- *Restore Standard Mouse*,
- *Restore Intellimouse*,
- *Power control* - only computers to which a user has access rights can be switched.

To get here

- 1 From a local or remote keyboard, log on as a standard (limited options) or 'admin' user.
- 2 Press **Ctrl** **Alt** **M** (hotkeys can change).
- 3 Press **F1** to select 'More menus'.
- 4 Select 'Functions'.

Restore Standard Mouse

This option is used to resume standard mouse operation if it has ceased to operate, for instance, if it has been connected without rebooting the AdderView CATx 1000.

Restore Intellimouse

This option is used to resume Microsoft Intellimouse operation if it has ceased to operate, for instance, if it has been connected without rebooting the AdderView CATx 1000.

Clear UTP Extender Password

Available only at the local console connection, this option places any X100 or X200 extender that is locked in password mode into configuration mode. The extended user can then clear or re-enter the password, as required.

Reset to Factory Defaults

Returns all key settings within the AdderView CATx 1000 to their original states.

WARNING: This function will clear all computer and user lists that are stored within the AdderView CATx 1000.

When this option is selected, you must press **F8** to confirm the action. The internal data will be rewritten and a completion message displayed after a short period.

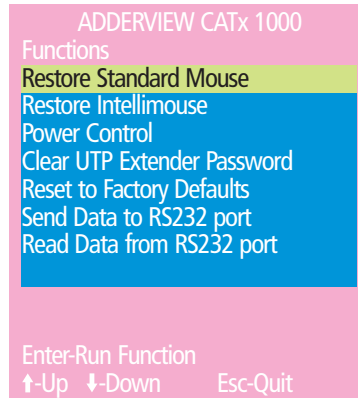

Power Control

The options within this section are usable only when the AdderView CATx 1000 is used in conjunction with one or more external power switch units. For more details see: power switching [connections](#), [configuration](#) or [operation \(via menu\)](#)

Switch Computer ON

Select this option to power on one or more computers.

Switch Computer OFF

Select this option to power off one or more computers.

Edit Power ON String

Select this option to alter the special codes that are sent from the AdderView CATx 1000 to the connected power switch(es) in order to switch computers on.

Edit Power OFF String

Select this option to alter the special codes that are sent from the AdderView CATx 1000 to the connected power switch(es) in order to switch computers off.

Send Data to RS232 port

This option is used to save AdderView CATx 1000 configuration information to a specially connected computer. A temporary link must be made using the **OPTIONS** port at the rear of the AdderView CATx 1000 and the computer must run a custom routine available from Adder Technology Limited. The resulting download file can be optionally edited (using a text editor or spreadsheet) and/or reloaded into the AdderView CATx 1000. This option is especially useful in complex cascade arrangements where many computers are attached. See [Saving and restoring configuration settings](#) for more details.

Read Data from RS232 port

This option is used to reload configuration information into the AdderView CATx 1000 from a specially connected computer. See above for more details.



INSTALLATION

CONFIGURATION

OPERATION

FURTHER INFORMATION

INDEX

User Preferences

The User Preferences are system operating parameters that are independently selectable for each user and affect only their screen.

To get here

- 1 From a local or remote keyboard, log on as a standard (limited options) or 'admin' user.
- 2 Press **Ctrl** **Alt** **M** (hotkeys can change).
- 3 Press **F1** to select 'More menus'.
- 4 Select 'User Preferences'.

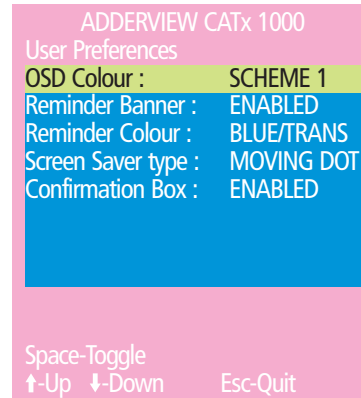

OSD Colour

Settings: *SCHEME 1, SCHEME 2, SCHEME 3*

As you toggle between these options you will see the colour of the menu change to show the selected scheme. The menu schemes have been specially chosen to provide a high contrast with the colours that you would normally see on a computer screen.

Reminder Banner

Settings: *ENABLED, DISABLED*

When the reminder banner is enabled, the name of the currently selected computer will appear in a small reminder banner. This is normally located at the top of the screen in a central position but may be moved as required (see [To move the reminder banner](#)).

Reminder Colour

Settings: *BLUE/TRANS, PINK/TRANS, BLUE/WHITE, WHITE/RED*

You can select the colour of the reminder banner. The BLUE/TRANS and PINK/TRANS select blue or pink text with a transparent background. The BLUE/WHITE and WHITE/RED settings select blue and white text on solid white and red backgrounds.

Screen Saver Type

Settings: *BLANK, MOVING DOT*

You can select the type of screen saver. If you select BLANK then the screen will blank completely. If you select MOVING DOT then a moving dot will be displayed on a blank background. The dot regularly changes colour and bounces off the sides of the screen in a zigzag pattern.

Confirmation Box

Settings: *DISABLED, ENABLED*

When enabled, a confirmation box is displayed on screen for three seconds after a computer is selected. The confirmation box indicates the current user port and user name, the selected computer and the connection status.



INSTALLATION

CONFIGURATION

OPERATION

FURTHER
INFORMATION

INDEX

Global Preferences

Global preferences are available only to the Admin user and allow settings to be made that affect all users attached to the AdderView CATx 1000.

To get here

- 1 From a local or remote keyboard, log on as a standard (limited options) or 'admin' user.
- 2 Press **Ctrl** **Alt** **M** (hotkeys can change).
- 3 Press **F1** to select 'More menus'.
- 4 Select 'Global Preferences'.

Mouse Switching

Settings: *ENABLED, DISABLED*

The computer channel can be switched using a three button mouse or IntelliMouse. Pressing the central button or wheel button together with the left hand mouse button will cause the AdderView CATx 1000 to switch to the next available computer. When mouse switching is enabled the central mouse button or wheel mouse button is allocated to control the AdderView CATx 1000 and is not therefore available for use by computer applications. If you want to use the central mouse button within your applications you will need to disable mouse switching. The rotation action of an IntelliMouse wheel is not affected and is always available to the computer application.

Screen Saver

Settings: *DISABLED; 2, 5, 7, 10,15, 20 & 30 MINUTES*

To avoid burning out the phosphor on CRT monitor screens, the AdderView CATx 1000 can be set to blank the screen after no keyboard or mouse activity has been detected for a selected timeout period. If preferred, the user can blank the screen manually by selecting channel '0' using the keyboard hotkeys or by pressing ESC from the login screen.

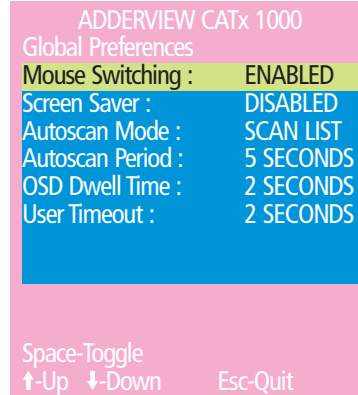

Autoscan Mode

Settings: *SCAN LIST, ACTIVE PCs, ALL PCs*

The AdderView CATx 1000 supports an autoscan mode that automatically scans between the connected computers in sequence. There are three autoscan modes. In the first mode the AdderView CATx 1000 will scan all the named computers that are defined in the autoscan list (SCAN LIST). The computers defined in the scan list may be connected to cascaded AdderView CATx 1000 units. If you wish to scan the ports on the current AdderView CATx 1000 then you may select ALL the available computers or just the available computers that are currently powered on (the ACTIVE computers). Scanning just the active computers avoids blank screens from being displayed and stops the monitor from going into a power down state on every scan cycle.

WARNING - Many modern monitors are fitted with automatic power save relays and will switch off after a few seconds if connected to an inactive PC. If you are using such a monitor you must not set the AdderView CATx 1000 to scan ALL ports. Constant switching on and off of your monitor's relay will eventually damage your monitor. If you are using the SCAN LIST option then you should ensure that all the computers are active if you are using one of these monitors.

If you choose to use the SCAN LIST option then you may define the computers to be scanned in the following manner.

To define the autoscan list

Note: *Ensure that you are [logged in](#) as the ADMIN user.*

- 1 From the main on-screen menu press F1 for MORE MENUS.
- 2 Select EDIT AUTOSCAN LIST from the menu. A list of defined computers will appear. Computers affixed with a '+' will be autoscanned during the autoscan cycle. To add/remove a computer to/from the autoscan list, move the selection bar over the computer name and press SPACE BAR. To add all named computers press F1. To remove all named computers press F2.
- 3 When all the computers that you wish to scan are affixed with a '+', press RETURN or ENTER to save the selections. The selected computers will be autoscanned in alphabetical order when you activate autoscan mode (when the SCAN LIST option is selected).

Autoscan Period

Settings: *DISABLED; 2, 5, 7, 15, 30 SECONDS, 1, 5 MINUTES*

The autoscan time defines the length of time that the AdderView CATx 1000 will display video (and play audio) from an autoscanned computer before changing to the next computer. If the DISABLED setting is chosen then no autoscan functions will be available.



Global Preferences (continued)

OSD Dwell Time

Settings: 1, 2, 3, 5, 10 SECONDS

After a successful computer channel change the AdderView CATx 1000 will display a confirmation message for a few seconds. The length of time that this confirmation message dwells on the screen may be changed.

User Timeout

Settings: 1, 2, 5, 10, 30 SECONDS, 1, 5, 10 MINUTES

When both a local and remote user wish to use the system, only one can have access at any one time. When no keyboard or mouse data has been received from the active user port for the user timeout period, the AdderView CATx 1000 will allow the other user to access the computer. The new port then becomes the active port until it too times out. To avoid confusion between users it is desirable to set the timeout period to be sufficiently long so that user's work is not needlessly interrupted by other users and sufficiently short to ensure good overall system efficiency. The user timeout value also controls the timeout between the local port and remote (extended) user port 1.



INSTALLATION

CONFIGURATION

OPERATION





FURTHER
INFORMATION

INDEX

Setup Options

Setup options are available only to the Admin user and consist of key settings that are normally made only during the initial installation stage.

To get here

- 1 From a local or remote keyboard, log on as a standard (limited options) or 'admin' user.
- 2 Press    (hotkeys can change).
- 3 Press  to select 'More menus'.
- 4 Select 'Setup Options'.

ADDERVIEW CATx 1000	
Setup Options	
Security :	ENABLED
Language :	ENGLISH
Hotkeys :	CTRL+ALT
Automatic Logout :	DISABLED
Audio :	ENABLED
Add Computers :	AUTO

Space-Toggle
↑-Up ↓-Down Esc-Quit

Security

Settings: *DISABLED, ENABLED*

With security disabled there is no requirement for users to log-in to the system. All users have full access to all the connected computers and full administration rights. With security enabled, users are required to log-in to the AdderView CATx 1000. Each user is allocated access rights to computers by the system administrator and they are only able to see the computers that they have access to on their on-screen menu.

Language

Settings: *ENGLISH, FRENCH, GERMAN, SWEDISH*

This option specifies the language that is used for the on-screen menu and the keyboard layout that is assumed for the keyboard. When the French option is selected the keyboard is assumed to have an AZERTY format. When the English, German and Swedish options are selected the keyboard is assumed to have a QWERTY format. The new language settings are enabled when you quit from the SETUP OPTIONS menu. The language option only affects the way that the AdderView CATx 1000 interprets the keyboard keys, it does not affect the way that the computers interpret the keyboard. It is advisable to avoid setting a language that you do not understand as all the menus will change to use the new language and you may have difficulty reselecting your original language.

Hotkeys

Settings: *CRTL+ALT, CTRL+SHIFT, ALT+SHIFT, ALT GR, L+R ALT, L CTRL+ALT, R CTRL+ALT*

The keyboard hotkeys are special combinations of keys that, when used together with certain keyboard "command keys", perform special AdderView CATx 1000 functions. For example, pressing the hotkeys together with the "M" key will cause the on-screen menu to be displayed on your monitor. Other hotkey combinations allow you to query which computer you are connected to and to move the on-screen menu around the screen. You can also use the hotkeys together with the port number to select a particular connected computer.

Automatic Logout

Settings: *DISABLED, ENABLED*

The AdderView CATx 1000 enables you to restrict access to your computers on a login basis. If a user forgets to logout when they have finished accessing the AdderView CATx 1000 then the user console may unintentionally be left with full access to all the computers. The AdderView CATx 1000 can be set to automatically logout unattended user consoles when the screen saver kicks in. This reduces the risk of security problems by preventing user consoles remaining in a permanent "logged-in" state when there is no keyboard or mouse activity. The automatic logout feature is only enabled when the screen saver feature is active (i.e. not disabled).

Audio

Settings: *ENABLED, DISABLED*

Allows you to enable and disable the audio capabilities of the AdderView CATx 1000 unit.

Add Computers

Settings: *AUTO, MANUAL*

Each time the master switch within a KVM cascade is power cycled, it checks for newly added computers. This option allows you to determine whether such new computers are automatically added to the computer list or whether you would prefer to update the list manually.



Advanced Options

Advanced options are available only to the Admin user and consist of settings that are related to specialist areas such as power control and DDC.

To get here

- 1 From a local or remote keyboard, log on as a standard (limited options) or 'admin' user.
- 2 Press **Ctrl** **Alt** **M** (hotkeys can change).
- 3 Press **F1** to select 'More menus'.
- 4 Press **F1** again to select 'Advanced menus'.
- 5 Select 'Setup Options'.

DDC Options

The options within this section are related to the Display Data Channel features supported by the AdderView CATx 1000. DDC is an industry standard format that allows computer systems to be informed of the capabilities of the video monitor connected to them.

DDC Source

Settings: *AUTO, LOCAL, REMOTE, DEFAULT*

Determines which user port monitor should be interrogated to discover its capabilities. *AUTO* begins with the local user port and if it fails, it then checks the remote port and if that also fails to produce a result, it uses a set of default values. The *LOCAL* and *REMOTE* settings force the unit to interrogate only the local and remote monitors respectively, and *DEFAULT* uses only the pre-programmed settings.

DDC Refresh

Settings: *AT START, DISABLED*

AT START sets the AdderView CATx 1000 to read DDC information from the selected source at power up. When *DISABLED*, no new DDC data is sought and existing information is used. When viewing this menu, press **F7** to discover DDC information from the chosen source immediately.

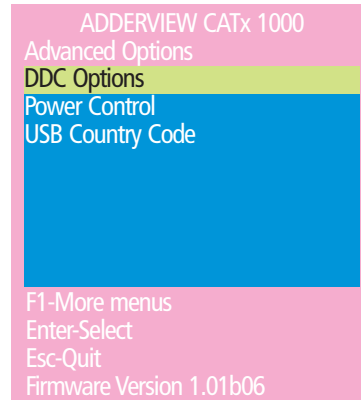

Power Control

The options within this section are concerned with the operation of the POWER CONTROL port when used to command optional system power control units.

Baud Rate

Settings: *1200, 2400, 4800, 9600, 19200, 38400, 57600, 115200*

Configures the communication speed of the POWER CONTROL port and must match the speed used by the connected power switch(es). Note: The PSU-8MASTER and PSU-8SLAVE power switches supplied by Adder require a setting of 9600.

Format

Settings: *NONE.8.1, ODD.8.1, EVEN.8.1, NONE.8.2, NONE.7.2, ODD.7.2, EVEN.7.2*

Configures the data format used by the serial port and must match the format used by the connected power switch(es). The NONE/ODD/EVEN portion relates to the parity checking; the 7/8 value is the size of the data byte and the 1/2 value determines the stop bit(s) used after each data byte.

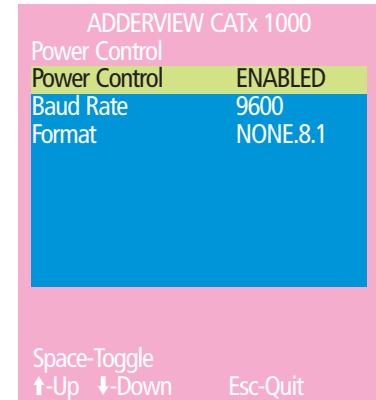

continued



INSTALLATION

CONFIGURATION

OPERATION

FURTHER INFORMATION

INDEX

USB Country Code

Some computers query the keyboard to find out its country code and key layout. These computers use this information to configure the way that they interpret the data coming from the keyboard and so it is important for the correct country information to be supplied. Not all keyboards report country information and two different styles of keyboard may be connected to the AdderView CATx 1000.

To get here

- 1 From a local or remote keyboard, log on as a standard (limited options) or 'admin' user.
- 2 Press **Ctrl** **Alt** **M** (hotkeys can change).
- 3 Press **F1** to select 'More menus'.
- 4 Press **F1** again to select 'Advanced menus'.
- 5 Highlight the USB Country Code option and press Enter.
- 6 Select 'Setup Options'.

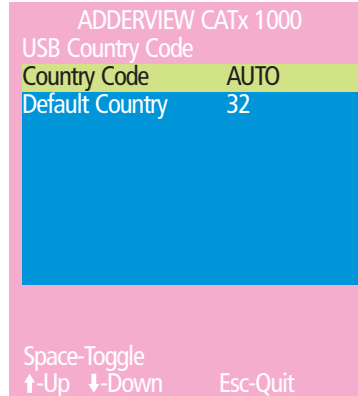

Default Country

The codes that may be used within this option are as follows:

Country	Code	Country	Code
Arabic	01	Persian (Farsi)	20
Belgian	02	Poland	21
Canadian-Bilingual	03	Portugese	22
Canadian-French	04	Russian	23
Czech Republic	05	Slovakian	24
Danish	06	Spanish	25
Finnish	07	Swedish	26
French	08	Swiss/French	27
German	09	Swiss/German	28
Greek	10	Switzerland	29
Hebrew	11	Taiwan	30
Hungary	12	Turkish-Q	31
International (ISO)	13	UK	32
Italian	14	US	33
Japan (Katakana)	15	Yugoslavia	34
Korean	16	Turkish-F	35
Latin American	17	Reserved	36-255
Netherlands	18	Not supported	00
Norwegian	19		

Country Code

Settings: *AUTO, MANUAL, DISABLED*

In AUTO mode the AdderView CATx 1000 will attempt to query the keyboard attached to the local port to ascertain a country code. If a country code is not found then the AdderView CATx 1000 will use the current value of the Default Country option. In MANUAL mode, the connected local keyboard is not queried for country information and instead the Default Country value is reported to all computers that request country information. In DISABLED mode, no country information is supplied to computers requesting country information.

Appendix 2 – Cable and connector specifications

RS232 serial flash upgrade cable

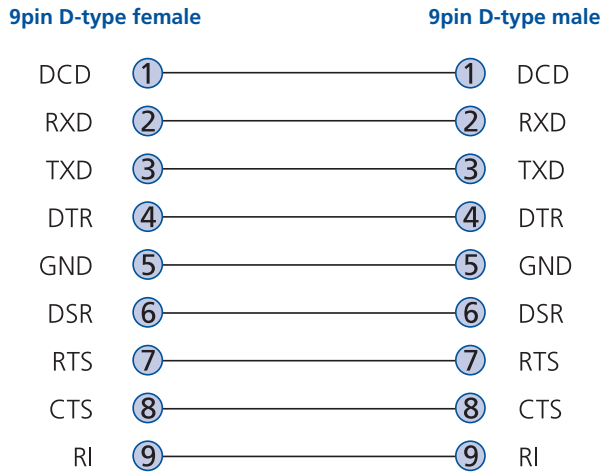

AdderView CATx 1000 to power switch cable

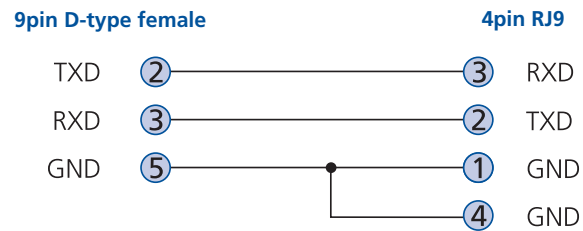

Power switch to power switch daisy chain cable

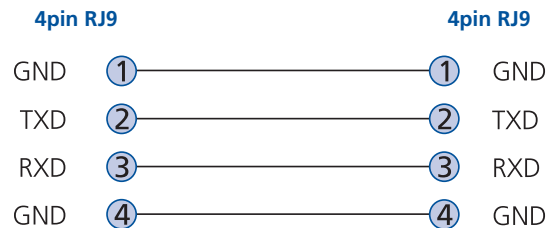

Multi-head synchronisation cable

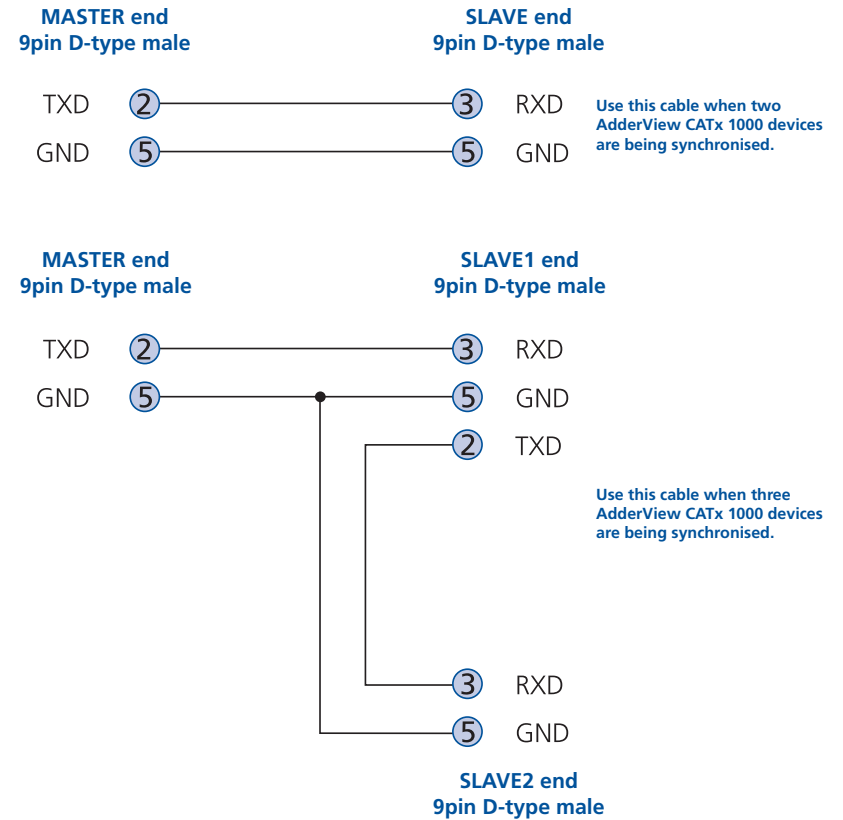

- INSTALLATION
- CONFIGURATION
- OPERATION
- FURTHER INFORMATION
- INDEX

Warranty

Adder Technology Ltd warrants that this product shall be free from defects in workmanship and materials for a period of two years from the date of original purchase. If the product should fail to operate correctly in normal use during the warranty period, Adder will replace or repair it free of charge. No liability can be accepted for damage due to misuse or circumstances outside Adder's control. Also Adder will not be responsible for any loss, damage or injury arising directly or indirectly from the use of this product. Adder's total liability under the terms of this warranty shall in all circumstances be limited to the replacement value of this product.

If any difficulty is experienced in the installation or use of this product that you are unable to resolve, please contact your supplier.

Safety information

- For use in dry, oil free indoor environments only.
- Both the AdderView CATx 1000 and its power supply generate heat when in operation and will become warm to the touch. Do not enclose them or place them locations where air cannot circulate to cool the equipment. Do not operate the equipment in ambient temperatures exceeding 40 degrees Centigrade. Do not place the products in contact with equipment whose surface temperature exceeds 40 degrees Centigrade.
- Warning - live parts contained within power adapter.
- No user serviceable parts within power adapter - do not dismantle.
- Plug the power adapter into a socket outlet close to the module that it is powering.
- Replace the power adapter with a manufacturer approved type only.
- Do not use the power adapter if the power adapter case becomes damaged, cracked or broken or if you suspect that it is not operating properly.
- If you use a power extension cord with the AdderView CATx 1000, make sure the total ampere rating of the devices plugged into the extension cord does not exceed the cord's ampere rating. Also, make sure that the total ampere rating of all the devices plugged into the wall outlet does not exceed the wall outlet's ampere rating.
- Do not attempt to service the AdderView CATx 1000 yourself.

Safety considerations when using power switches with AdderView CATx 1000

- Follow the manufacturer's instructions when setting up and using power switching products.
- Always ensure that the total ampere rating of the devices plugged into the power switching product does not exceed the power switching product's ampere rating. Also, make sure that the total ampere rating of all the devices plugged into the wall outlet does not exceed the wall outlet's ampere rating.



INSTALLATION

CONFIGURATION

OPERATION

FURTHER
INFORMATION

INDEX

Radio Frequency Energy

A Category 5 (or better) twisted pair cable must be used to connect the units in order to maintain compliance with radio frequency energy emission regulations and ensure a suitably high level of immunity to electromagnetic disturbances.

All other interface cables used with this equipment must be shielded in order to maintain compliance with radio frequency energy emission regulations and ensure a suitably high level of immunity to electromagnetic disturbances.

European EMC directive 89/336/EEC

This equipment has been tested and found to comply with the limits for a class A computing device in accordance with the specifications in the European standard EN55022. These limits are designed to provide reasonable protection against harmful interference. This equipment generates, uses and can radiate radio frequency energy and if not installed and used in accordance with the instructions may cause harmful interference to radio or television reception. However, there is no guarantee that harmful interference will not occur in a particular installation. If this equipment does cause interference to radio or television reception, which can be determined by turning the equipment on and off, the user is encouraged to correct the interference with one or more of the following measures: (a) Reorient or relocate the receiving antenna. (b) Increase the separation between the equipment and the receiver. (c) Connect the equipment to an outlet on a circuit different from that to which the receiver is connected. (d) Consult the supplier or an experienced radio/TV technician for help.

FCC Compliance Statement (United States)

This equipment generates, uses and can radiate radio frequency energy and if not installed and used properly, that is, in strict accordance with the manufacturer's instructions, may cause interference to radio communication. It has been tested and found to comply with the limits for a class A computing device in accordance with the specifications in Subpart J of part 15 of FCC rules, which are designed to provide reasonable protection against such interference when the equipment is operated in a commercial environment. Operation of this equipment in a residential area may cause interference, in which case the user at his own expense will be required to take whatever measures may be necessary to correct the interference. Changes or modifications not expressly approved by the manufacturer could void the user's authority to operate the equipment.

Canadian Department of Communications RFI statement

This equipment does not exceed the class A limits for radio noise emissions from digital apparatus set out in the radio interference regulations of the Canadian Department of Communications.

Le présent appareil numérique n'émet pas de bruits radioélectriques dépassant les limites applicables aux appareils numériques de la classe A prescrites dans le règlement sur le brouillage radioélectriques publié par le ministère des Communications du Canada.



INSTALLATION

CONFIGURATION

OPERATION

FURTHER
INFORMATION

INDEX

© 2008 Adder Technology Limited
All trademarks are acknowledged.
Release 1.0e
November 2008
Part No. ADD0075

Adder Technology Limited,
Technology House,
Trafalgar Way, Bar Hill,
Cambridge, CB23 8SQ,
United Kingdom
Tel: +44 (0)1954 780044
Fax: +44 (0)1954 780081

Adder Corporation,
29 Water Street,
Newburyport,
MA 01950,
United States of America
Tel: +1-888-932-3337
Fax: +1-888-275-1117

Adder Asia Pacific
6 New Industrial Road,
Hoe Huat Industrial Building
#07-01,
Singapore 536199
Tel: +65 6288 5767
Fax: +65 6284 1150

INSTALLATION

CONFIGURATION

OPERATION

FURTHER
INFORMATION

INDEX

Index



A

- Access
 - local and remote users 33
- Addressing
 - cascaded computers 15
 - power switch boxes 12
- ADMIN
 - forgotten password 29
 - password 20
- Advanced options 46
- Assistance
 - from Adder 39
- Autoscanning 26

B

- Baud rate 46
- Brackets 5
 - fitting 6

C

- Cable lengths
 - to computers 10
 - to remote users 9
- Cable specifications 48
- CAM
 - connection 10
- Cascade connections
 - addressing 15
 - introduction 13
 - tips for success 14
- Cascaded computers
 - selecting 36

Compensation

- for computer links 23
- for remote user links 23

Computer

- connection 10
- name editing 22
- ports 4
- registering 22
- selecting 33

Computer Access Module

- connection 10

Configuration

- menus 19,40
- overall steps 18
- saving and restoring 27

Configuration settings

- saving and restoring 27

Confirmation box

- 37

Connections

- Computer Access Module 10
 - computer system 10
 - global user 10
 - host computer 8
 - keyboard 8
 - local user 8
 - multiple video head 16
 - power control 12
 - power supply 11
 - remote user 9

Connector specifications

- 48

Control strings

- power switching 30

D

- Daisy chain cable 48
- Data Transfer utility 27
- DDC
 - options 46,47

E

- Extender
 - remote user 9

F

- Firmware
 - upgrade 29,31
- Format
 - power control port 46
- Functions 41,46

G

- Global preferences 43,46
- Global user
 - access 30
 - connection 10

H

- Host computer
 - connecting 8
 - connection 10
 - power switching setup 30
- Hotkeys
 - changing 20
 - selecting computers 33
- Hot plugging 29

I

- Indicators 4
- Initial configuration 18
- IP port
 - connection 10

L

- Local connection 33
- Local user
 - connection 8
 - port 4
- Logging in and out
 - section 36

M

- Mounting 6
- Multiple video head
 - connections 16

N

- Network port
 - connection 10

O

- Operation 33

P

- Parts
 - supplied and extra 5
- Password
 - admin 20
 - forgotten 29
- Power control
 - connection 12
 - options 46
- Power strings
 - for switching 30
- Power supply
 - connecting 11
 - part number 5
- Power switching
 - addressing 12
 - configuration 30
 - connection 12
 - control sequences 30
- R
 - Rack mounting 6
 - Reminder banner 37
 - Remote user
 - cable lengths 9
 - connection 9
 - ports 4
 - Restoring
 - configuration settings 27
 - RJ9 connector 12
 - Routing status 37

INSTALLATION

CONFIGURATION

OPERATION

FURTHER INFORMATION

INDEX

S

- Safety information 49
- Saving
 - configuration settings 27
- Security
 - enabling 20
 - general steps 20
- Selecting
 - cascaded computers 36
 - computers 33
 - with hotkeys 33
 - with mouse buttons 35
 - with on-screen menu 34
- Setup options 41,45
- Skew adjustment 24
- Supplied items 5

T

- Troubleshooting 39

U

- Upgrade
 - firmware 29,31
- User list
 - editing 21
- User preferences 42,45

V

- Video compensation 23

W

- Warranty 49

X

- X100 extender 9
- X200 extender 9



INSTALLATION

CONFIGURATION

OPERATION

FURTHER
INFORMATION

INDEX