

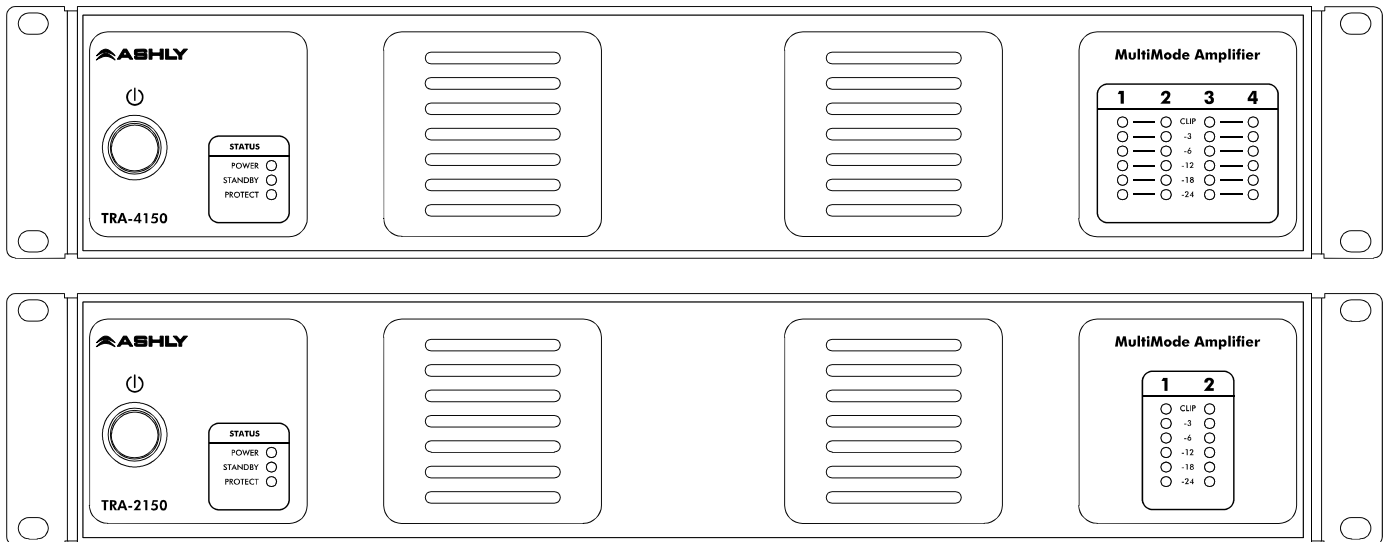

TRA-Series Amplifier

Operating Manual



**Ashly Audio Inc.**

847 Holt Road, Webster, NY 14580-9103

Toll Free (800) 828-6308, Telephone (585) 872-0010, FAX (585) 872-0739

[www.ashly.com](http://www.ashly.com)

All Trademarks referred to herein, are the property of their respective owners. (R7 0313)

All Rights Reserved

Important Safety  
Instructions - 2

Introduction - 3

The TRA Series - 4

Physical Description - 5

Installation - 6

Operation - 8

Troubleshooting - 9

Spec Table - 10

Dimensions - 11

Warranty - 12

This manual uses a *Perpetual Table Of Contents*. Each page has a copy of the manual's contents in a gray box just like this one. The section you are in will always be bold with the other sections "grayed out." The feature allows you to jump directly to another section without having to return to a Table Of Contents page.

## Important Safety Instructions Consignes de sécurité à lire attentivement

This power amplifier can produce dangerous output voltage, power and sound pressure levels. In order to minimize the risk of injury, damage, or hearing loss, please read the entire owner's manual.

Cet amplificateur de puissance peut produire un voltage et une pression acoustique qui pourrait être dangereuse ou pourrait même causer des problèmes ou perte d'acuité auditive. Consultez le manuel d'instruction et observez les consignes.



*The lightning flash with arrowhead symbol, within an equilateral triangle, is intended to alert the user to the presence of uninsulated "dangerous voltage" within the product's enclosure that may be of sufficient magnitude to constitute a risk of electric shock to persons. The exclamation point within an equilateral triangle is intended to alert the user to the presence of important operating and maintenance instructions in the literature accompanying the device.*

*Le symbole de la flèche dans un triangle équilatéral symbolisant la foudre est prévu pour sensibiliser l'utilisateur à la présence de tension de voltage non isolée à l'intérieur de l'appareil. Elle pourrait constituer un danger de risque de décharge électrique pour les utilisateurs. Le point d'exclamation dans le triangle équilatéral alerte l'utilisateur de la présence de consignes qu'il doit d'abord consulter avant d'utiliser l'appareil.*

1. Read these instructions.
  2. Keep these instructions.
  3. Heed all warnings.
  4. Follow all instructions.
  5. To reduce the risk of fire or electric shock, do not expose this apparatus to rain or moisture.
  6. Do not use this apparatus near water.
  7. Clean only with dry cloth.
  8. Do not block any ventilation openings. Install in accordance with the manufacturer's instructions.
  9. Do not install near any heat sources such as radiators, heat registers, stoves, or other apparatus (including amplifiers) that produce heat.
  10. Do not defeat the safety purpose of the polarized or grounding-type plug. A polarized plug has two blades with one wider than the other. A grounding type plug has two blades and a third grounding prong. The wide blade or the third prong are provided for your safety. If the provided plug does not fit into your outlet, consult an electrician for replacement of the obsolete outlet.
  11. Protect the power cord from being walked on or pinched particularly at plugs, convenience receptacles, and the point where they exit from the apparatus.
  12. Only use attachments/accessories specified by the manufacturer.
  13. Use only with the cart, stand, tripod, bracket, or table specified by the manufacturer, or sold with the apparatus. When a cart is used, use caution when moving the cart/apparatus combination to avoid injury from tip-over.
  14. Unplug this apparatus during lightning storms or when unused for long periods of time.
  15. Refer all servicing to qualified service personnel. Servicing is required when the apparatus has been damaged in any way, such as power-supply cord or plug is damaged, liquid has been spilled or objects have fallen into the apparatus, the apparatus has been exposed to rain or moisture, does not operate normally, or has been dropped.
1. Lisez ces instructions.
  2. Conservez ces instructions.
  3. Observez les avertissements.
  4. Suivez ces instructions.
  5. Pour réduire le risque de feu ou la décharge électrique, ne pas exposer cet appareil pour pleuvoir ou l'humidité. Ne pas utiliser l'appareil près de l'eau.
  7. Le nettoyer à l'aide d'un tissu sec.
  8. Ne pas bloquer les ouvertures de ventilation, installer selon les consignes du fabricant.
  9. Eloigner des sources de chaleur tel: radiateurs, fourneaux ou autres appareils qui produisent de la chaleur.
  10. Ne pas modifier ou amputer le système de la mise à terre. Une prise avec mise à terre comprend deux lames dont une plus large ainsi qu'une mise à terre: ne pas la couper ou la modifier. Si la prise murale n'accepte pas la fiche, consulter un électricien pour qu'il remplace la prise défectueuse.
  11. Protéger le cordon de secteur contre tous bris ou pincement qui pourraient l'endommager, soit à la fiche murale ou à l'appareil.
  12. N'employer que les accessoires recommandés par le fabricant.
  13. N'utiliser qu'avec les systèmes de fixation, chariots, trépied ou autres, approuvés par le fabricant ou vendus avec l'appareil.
  14. Débrancher l'appareil lors des orages électriques ou si inutilisé pendant une longue période de temps.
  15. Un entretien effectué par un centre de service accrédité est exigé si l'appareil a été endommagé de quelque façon: si il a été exposé à la pluie, l'humidité ou s'il ne fonctionne pas normalement ou qu'il a été échappé.

## Introduction

Congratulations on your purchase of an Ashly TRA-Series amplifier. The TRA-Series is made up of high-efficiency, amplifiers incorporating the latest technologies. We are confident that you will be pleased with the high performance, superb sound quality, reliability, and more.

### About Ashly

Ashly Audio was founded in 1974 by a group of recording engineers, concert sound professionals, and electronics designers. The first products were elaborate custom consoles for friends and associates, but business quickly spread to new clients and the business grew. The philosophy we established from the very beginning holds true today: to offer only the highest quality audio tools at an affordable cost to the professional user – ensuring reliability and long life. More than thirty years later, Ashly remains committed to these principles.

Ashly's exclusive Five Year, Worry- Free Warranty remains one of the most liberal policies available on any commercial- grade product. The warranty covers every product with the Ashly brand name, and is offered at no extra cost to you, our customer.

### FCC Compliance

This device complies with part 15 of the FCC Rules. Operation is subject to the following two conditions:

1. This device may not cause harmful interference
2. This device must accept any interference received, including interference that may cause undesired operation.

*Note: This equipment has been tested and found to comply with the limits for a Class B digital device, pursuant to part 15 of the FCC Rules. These limits are designed to provide reasonable protection against harmful interference in both a commercial and residential installation. This equipment generates, uses and can radiate radio frequency energy and, if not installed and used in accordance with the instructions, may cause harmful interference to radio communications. However, there is no guarantee that interference will not occur in a particular installation. If this equipment does cause harmful interference to radio or television reception, which can be determined by turning the equipment off and on, the user is encouraged to try to correct the interference by one or more of the following measures:*

- Reorient or relocate the receiving antenna.
- Increase the separation between the equipment and receiver.
- Connect the equipment into an outlet on a circuit different from that to which the receiver is connected.
- Consult the dealer or an experienced radio/TV technician for help.

Important Safety Instructions - 2
Introduction - 3
About Ashly Safety FCC Compliance
The TRA Series - 4
Physical Description - 5
Installation - 6
Operation - 8
Troubleshooting - 9
Spec Table - 10
Dimensions - 11
Warranty - 12

Important Safety  
Instructions – 2

Introduction - 3

The TRA Series - 4  
Protection

Physical Description - 5

Installation - 6

Operation - 8

Troubleshooting - 9

Spec Table - 10

Dimensions - 11

Warranty - 12

## The TRA Series

TRA-Series amplifiers are high-efficiency, amplifiers incorporating the latest amplifier technologies.

The series provides a power range of 75 to 150 watts per channel at 4 ohms (20Hz-20kHz, 1% THD). The TRA series is available in 2 and 4 channel versions at two power points. All models will drive 4 or 8 ohm loads as well as 25V, 70V, and 100V constant voltage lines. All models are 2RU, with the two and four channel versions weighing 19.5 pounds and 29.5 pounds respectively. All TRA amplifiers utilize a state-of-the-art, efficient, high speed switched mode power supply and offer remote power on/off among the standard features.

TRA-Series Power Ratings (per channel)			
Model	Stereo		Constant Voltage
	8Ω	4Ω	25/70V/100V
TRA-2075	40 W	75 W	75 W
TRA-4075	40 W	75 W	75 W
TRA-2150	80 W	150 W	150 W
TRA-4150	80 W	150 W	150 W

Input connections are via 3-pin Euroblock connectors.

Output connectors are screw terminal strips.

Controls on the rear panel include: Gain and channel attenuation.

### Protection

TRA-Series Amplifiers come standard with several protection circuits:

- ✦ **Output over-current protection** - The output current is limited to safe levels regardless of load.
- ✦ **DC output protection** - The amplifier is switched off if more than 2 volts of dc is present on the output. The amplifier will automatically restart after 5 seconds (if no fault remains). The protect LED is lit as well as the clip LED of the affected channel(s).
- ✦ **Main supply rail overvoltage protection** - The amplifier is switched off if the main supply rails have too high of a voltage. The amplifier will automatically restart after 5 seconds (if no fault remains). The protect LED is lit as well as the clip LED of the affected channel(s).
- ✦ **Chassis internal temperature monitoring** - The amplifier is switched off when the internal ambient temp reaches 70° C. The amplifier will again switch on when the internal ambient temp reaches 55° C. The protect LED is lit as well as the clip LED of ALL channels.
- ✦ **Inrush limiting** - The turn-on current is limited. This is active during initial startup as well as when exiting standby mode.
- ✦ **Mains fuse** - There is a 5 amp time delay fuse.

## Physical Description

TRA-Series models generally have the same physical design, though there are obvious differences between two and four channel versions. The model number is indicated on the left side of the front panel

### Amplifier Front Panel

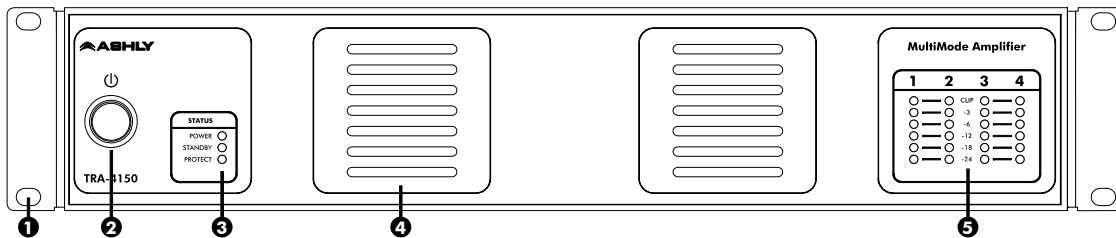

1. **Mounting Holes** – For rack mounting.
2. **Power Switch** – Switches the unit on or off
3. **Status LEDs** – Indicate status of Power, Standby, and Protect
4. **Air Vents**
5. **Channel LEDs** – The Sig LED will begin to light when the output voltage reaches approximately 0.3 volts. When clipping occurs the Clip LED will light.

### Amplifier Rear Panel

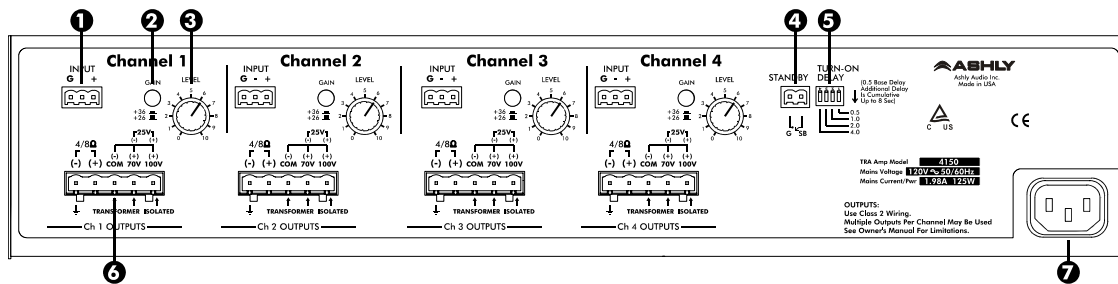

1. **3-Pin Euroblock Input Connectors** – These connectors are used for all input signals.
2. **Gain Switch** – sets the amplifier gain to +36dB or +26dB sensitivity.
3. **Channel Attenuators** – These knobs adjust the attenuation of the input signal of each channel from  $\infty$  to 0.  
*Items 1-4 are identical on all channels of all TRA-Series amplifiers, 2 or 4 channel.*
4. **Standby Connector** – This 2-Pin Euroblock connector provides for remote standby switching. The Power switch must be in the On position for the Standby connector to be active.
5. **Delay Switches** – These switches provide turn on delay when the Standby connector is used. The switches are additive, providing as much as 7.5 seconds of delay
6. **Screw Terminal Output Connectors** – These connectors provide the output signal for each channel. The positive  $4/8 \Omega$  (+) and negative (-) connectors should be used for low-impedance applications. For constant voltage 70V or 100V applications, connect the negative wire (-) of your system to the C (common) terminal and the positive (+) wire to the appropriate Constant Voltage output. For 25V, wire as shown.
7. **Mains Connector** - Connection to the mains is via this 3-Prong IEC connector

**WARNING:** Do not remove the mains connector ground.

Important Safety Instructions – 2

Introduction - 3

The TRA Series - 4

Physical Description - 5  
 Front Panel  
 Rear Panel

Installation - 6

Operation - 8

Troubleshooting - 9

Spec Table - 10

Dimensions - 11

Warranty - 12

Terminals marked with are HAZARDOUS LIVE. External wiring to these terminals/ connectors requires installation by trained personnel, or pre-manufactured cables

Important Safety Instructions – 2
Introduction - 3
The TRA Series - 4
Physical Description - 5
Front Panel
Rear Panel
Installation – 6
Requirements
Typical Applications
Connectors & Polarity
Operation - 8
Troubleshooting - 9
Spec Table - 10
Dimensions - 11
Warranty - 12

## Installation

TRA-Series amplifiers are designed for use in both fixed and mobile sound systems. Each amplifier is shipped (unless otherwise specified) with the following factory settings:

Front panel:	Rear panel:
On/Off Switch = Off Attenuators = $\infty$	Gain Selector = +26 dB

Before connecting to mains power, make sure that the switches are set to the configuration needed for your particular application. Always switch the amplifier off before making any changes to the settings. Failure to do so could result in damage to the unit or other components in your system. **CAUTION:** When mounting or connecting the amplifier, always disconnect it from the mains. Use four screws and washers when mounting the amplifier to the front rack rails. Rear support is also recommended, especially for mobile or touring use. To reduce the risk of fire or electric shock, do not expose this apparatus to rain or moisture.

### Requirements

TRA-Series amplifiers have specific physical, electrical and signal requirements for proper operation. These requirements will vary depending on your specific application, setup, and the settings on the amplifier. When setting up and testing your system, please take special care to double check all connections and settings. Please refer to the specifications section of this manual for specific input, output and other figures.

### Typical Applications

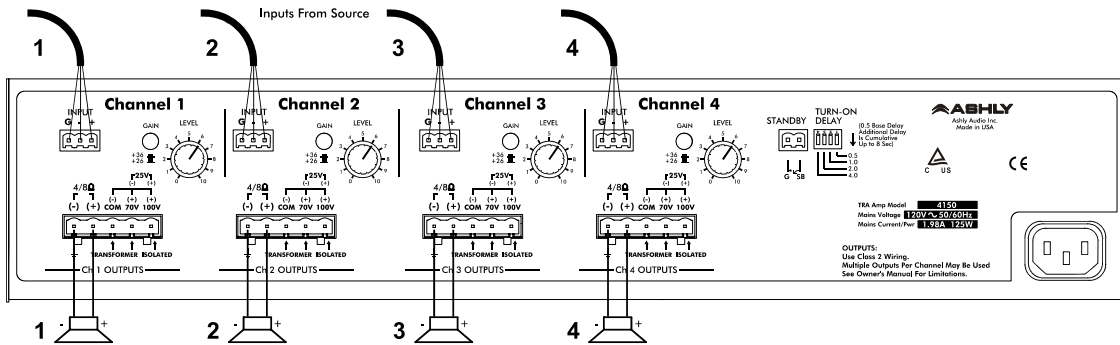

TRA-Series amplifiers offer many output options. In this illustration, the 4-channel amplifier is receiving two stereo signals and is driving two pairs of stereo speakers.

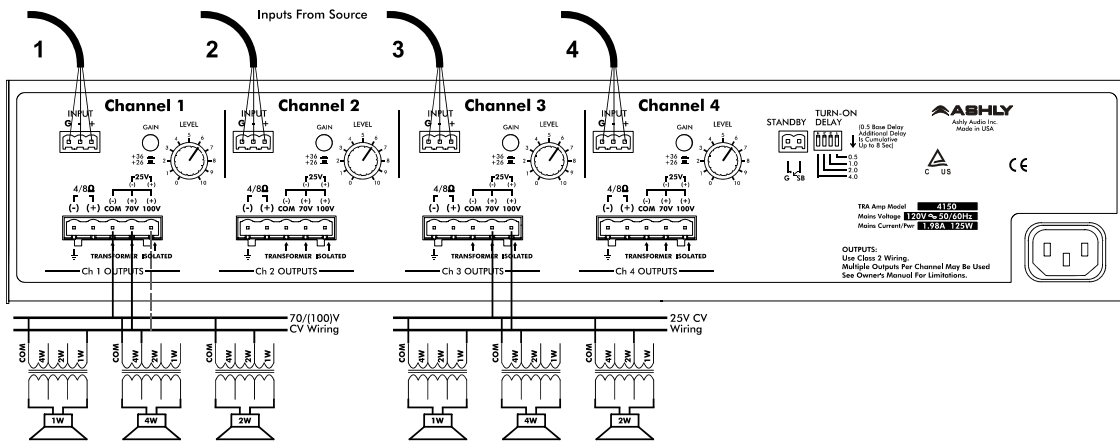

TRA-Series amplifiers are specifically designed to drive transformer isolated 25V, 70V, or 100V constant voltage (CV) lines. This illustration example shows a 4 channel TRA driving a 70V CV line and 25V line (with two channels still available). Always make sure that the total wattage draw from all the speakers on a CV line does not exceed the rated output of the channel to which they are connected.

### Connectors & Polarity

TRA-Series amplifiers utilize professional euroblock audio connectors. For the inputs, 3-pin Euroblock connectors are utilized with their polarity clearly marked on the amplifier's rear panel. Outputs are also euroblock connectors, with polarity clearly marked on the chassis.

**NOTE:** It is possible to simultaneously drive loads connected to the 8/4 ohm output AND the 25/70/100 volt outputs of a particular amplifier channel. However, care must be taken to ensure that the combined load is not less than the 4 ohm maximum. If you are unsure as to how to determine the combined load, please contact Ashly.

Important Safety Instructions – 2  
 Introduction - 3  
 The TRA Series - 4  
 Physical Description - 5  
 Installation – 6  
 Requirements  
 Typical Applications  
 Connectors & Polarity  
 Operation - 8  
 Troubleshooting - 9  
 Spec Table - 10  
 Dimensions - 11  
 Warranty - 12

Important Safety  
Instructions – 2  
Introduction - 3  
The TRA Series - 4  
Physical Description - 5  
Installation – 6  
**Operation – 8**  
Troubleshooting - 9  
Spec Table - 10  
Dimensions - 11  
Warranty - 12

## Operation

The amplifier's On/Off Switch is a rocker-type switch located on the left side of the front panel. Turning on the amplifier initiates start-up by activating the inrush current limiter.

When using the remote On/Off function, the main On/Off switch must remain in the On position. See page 11 for more information on remote On/Off connections.

**NOTE:** The power switch does NOT isolate the appliance from mains. Make sure the mains power socket or an alternative disconnect device is near by and easily accessible. When the product is connected to mains, the line-filter and the input of the fuse are energized.



## Troubleshooting

Situation	Indication	Action
No Sound	Signal LED not lit Clip LEDs not lit	Check AC plug. Confirm that AC outlet works by plugging in another device.
	Signal LED not lit	Make sure the signal source is operating and try another cable. Check position of channel attenuators.
	Signal LEDs responding to signal level	Check the speaker wiring for breaks. Try another speaker and cable.
	Signal LEDs show red (Protect Mode)	Overheating will cause protective muting. Check for proper ventilation.
No Channel Separation	No Channel Separation	Check the mode indicators on the front panel and make sure the mode selector on the rear panel is in the two channel (stereo) position. Make sure other equipment in the signal path such as mixers and preamps are set for stereo, not mono
Distorted Sound	Power LED is lit	A faulty speaker or a loose connection could cause this. Check the wiring and try another speaker.
	Signal LEDs responding to signal level	The signal source might be clipping. Keep the volume pots at least halfway up so that the source does not have to be overdriven.
	Clip LEDs not lit	Keep the volume pots at least halfway up and try changing input sensitivity with the gain selector on the rear.
Hiss	Hiss	Unplug the amplifier input to confirm that the hiss is coming from the source or from a device upstream. Erratic or popping noises indicate an electronic fault in the offending unit. To keep the noise floor low, operate the primary signal source at full level, without clipping. Avoid boosting the signal further between the source and the amplifier.
Squeals and Feedback	Squeals and Feedback	Microphone feedback should be eliminated with mixer controls. If noise continues to build up with no microphone gain, there is a serious fault in the signal processors or cables. Working in succession from the signal source towards the amplifier and check each device in the signal path by reducing its gain or by unplugging it.

Important Safety Instructions – 2  
 Introduction - 3  
 The TRA Series - 4  
 Physical Description - 5  
 Installation – 6  
 Operation – 8  
**Troubleshooting - 9**  
 Spec Table - 10  
 Dimensions - 11  
 Warranty - 12

Important Safety  
Instructions – 2

Introduction - 3

The TRA Series - 4

Physical Description - 5

Installation – 6

Operation – 8

Troubleshooting - 9

**Spec Table - 10**

Dimensions - 11

Warranty - 12

**Spec Table**

	<i>TRA-2075</i>	<i>TRA-4075</i>	<i>TRA-2150</i>	<i>TRA-4150</i>
<b>Power Output Per Channel</b>				
8 ohms, 80 Hz - 20 kHz, 1% THD	40 W	40 W	80 W	40 W
4 ohms, 80 Hz - 20 kHz, 1% THD	75 W	75 W	150 W	150 W
25V/70V/100V CV, 80 Hz - 20 kHz, 1% THD	75 W	75 W	150 W	150 W
<b>Line Current Draw (all channels driven @4Ω)</b>				
Standby	37mA	39mA	89mA	102mA
Idle	320mA	565mA	370mA	660mA
1/8 <sup>th</sup> Power Pink Noise	0.70A	1.25A	1.10A	1.95A
1/3 Power Sine Wave	1.23A	2.25A	2.10A	3.80A
<b>Thermal Dissipation (all channels driven @4Ω)</b>				
Standby (BTU /hr)	13	15	14	23
Idle (BTU/hr)	61	113	72	137
1/8 <sup>th</sup> Power Pink Noise (BTU/hr)	73	145	111	211
1/3 Power Sine Wave (BTU/hr)	85	150	126	263
Signal to Noise (20 Hz-20 kHz, unweighted):	>100 dB	>100 dB	>103 dB	>103 dB
Voltage Gain:	26 dB, 36 dB sensitivity (selectable)			
Output Circuitry:	Class D	Class D	Class D	Class D
Frequency Response	80 Hz - 20 kHz –3dB +/- 1.0 dB (due to internal 80 Hz HPF)			
Distortion (SMPTE, typical)	< 0.5% - 8Ω load, 10dB below rated power			
Distortion (THD-N, typical)	< 0.5% - 8Ω load, 10dB below rated power, 20Hz-20kHz			
Damping Factor - 8 ohm load, < 1 kHz	> 200 into 8Ω			
Input Impedance	20 kΩ, balanced			
Maximum Input Level:	+21 dBu			
Input Impedance	20kΩ balanced			
Cooling	Convection			
Front Panel Indicators per channel	Clip & Signal			
Front Panel Indicators overall	power, standby, protect			
Attenuators	Per channel: front panel			
Input Connectors, each channel	3- Pin Euroblock			
Output connectors, each channel	Screw terminals			
Amplifier Protection	Output Overcurrent, DC Output, Main Supply Rail Overvoltage Chassis Temperature, Inrush Limiting, Mains Fuse			
Power Cable Connector	3-Prong IEC			
Dimensions	19" x 3.5" x 11"			
Weight	19.5 lbs	29.5 lbs	19.5 lbs	29.5 lbs

*All Specifications Subject to Change or Improvement Without Notice.*

## Amplifier Dimensions

All TRA Series amplifiers share the same dimensional measurements:

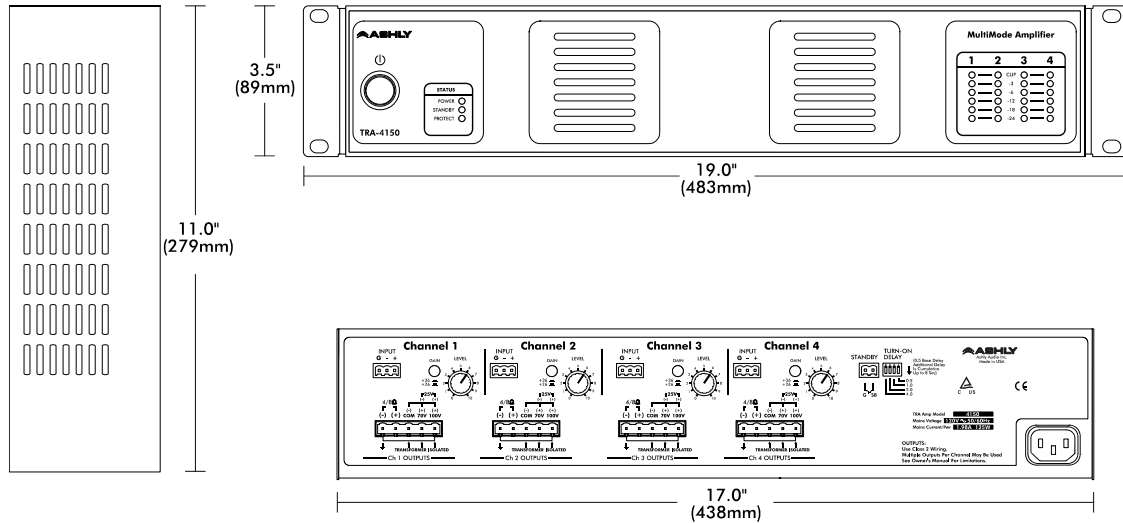

## Remote Power Connections

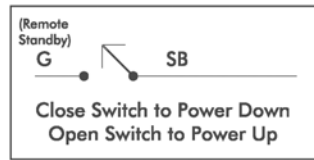

Remote Standby

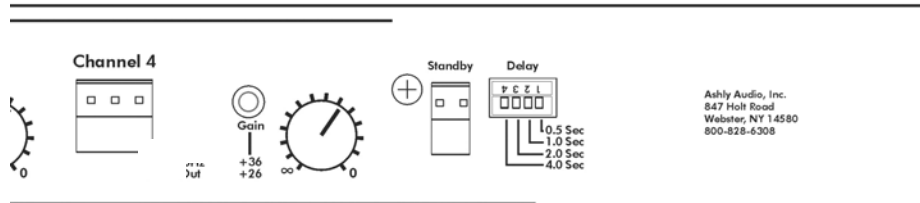

Ashly Audio, Inc.  
847 Holt Road  
Webster, NY 14580  
800-828-6308

- Important Safety Instructions – 2
- Introduction - 3
- The TRA Series - 4
- Physical Description - 5
- Installation – 6
- Operation – 8
- Troubleshooting - 9
- Spec Table - 10
- Dimensions - 11
- Warranty - 12

Important Safety  
Instructions – 2  
Introduction - 3  
The TRA Series - 4  
Physical Description - 5  
Installation – 6  
Operation – 8  
Troubleshooting - 9  
Spec Table - 10  
Dimensions - 11  
Warranty - 12

## Ashly Audio Inc. Limited Warranty (USA ONLY)

(Other countries please contact your respective dealer or distributor)

**For units purchased in the USA**, warranty service for this unit shall be provided by ASHLY AUDIO, INC. in accordance with the following warranty statement:

ASHLY AUDIO, INC. warrants to the owner of this product that it will be free from defects in workmanship and materials for a period of FIVE years from the original date of purchase. ASHLY AUDIO INC. will without charge, repair or replace at its discretion any defective product or component parts upon prepaid delivery of the product to the ASHLY AUDIO, INC. factory service department, accompanied with a proof of original date of purchase in the form of a valid sales receipt. This warranty gives you specific legal rights, and you may also have other rights, which vary from state to state.

**EXCLUSIONS:** This warranty does not apply in the event of misuse, neglect or as a result of unauthorized alterations or repairs made to the product. This warranty is void if the serial number is altered, defaced, or removed. ASHLY AUDIO reserves the right to make changes in design, or make additions to, or improvements upon this product, without any obligation to install the same on products previously manufactured.

Any implied warranties which may arise under the operation of state law shall be effective only for FIVE years from the original date of purchase of the product. ASHLY AUDIO, INC. shall be obligated to only correct defects in the product itself. ASHLY AUDIO, INC. is not liable for any damage or injury which may result from or be incidental to or a consequence of such defect. Some states do not allow limitations on how long an implied warranty lasts, or the exclusion, or limitation of incidental or consequential damages, so the above limitations or exclusions may not apply to you.

### OBTAINING WARRANTY SERVICE:

For warranty service in the United States, please follow this procedure:

- 1.) Return the product to ASHLY AUDIO, INC, freight prepaid, with a written statement describing the defect and application that the product is used in. ASHLY AUDIO, INC. will examine the product and perform any necessary service, including replacement of defective parts, at no further cost to you.
- 2.) Ship your product to:  
Ashly Audio Inc.  
Attn: Service Department  
847 Holt Road  
Webster, NY 14580-9103