

datavideo

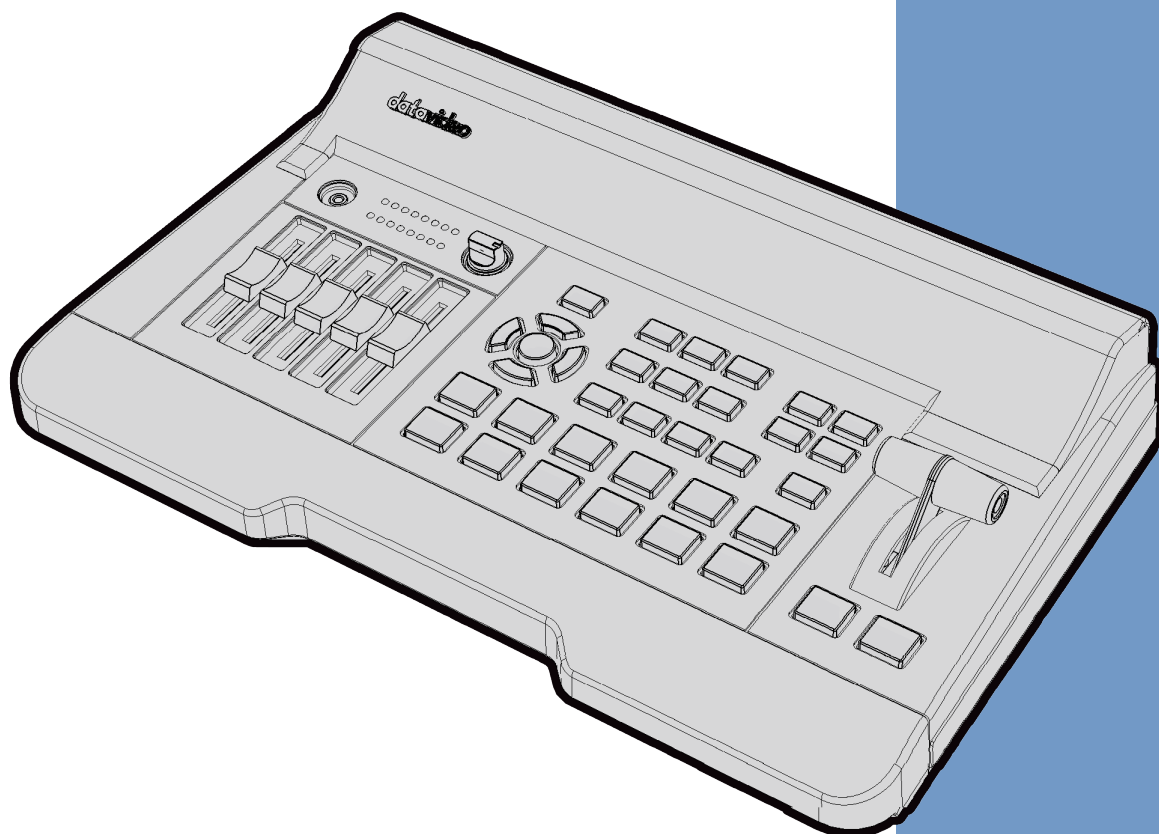

**HD/SD 4-CHANNEL
DIGITAL VIDEO SWITCHER
SE-500HD**

Instruction Manual

www.datavideo.com

Table of Contents

FCC COMPLIANCE STATEMENT	4
WARNINGS AND PRECAUTIONS	4
WARRANTY	5
STANDARD WARRANTY	5
THREE YEAR WARRANTY	5
DISPOSAL	5
CHAPTER 1 INTRODUCTION	6
1.1 FEATURES.....	6
1.2 SYSTEM DIAGRAM	6
CHAPTER 2 CONNECTIONS AND CONTROLS	7
2.1 REAR PANEL	7
2.2 FRONT PANEL	9
CHAPTER 3 OSD MENU	14
3.1 START.....	14
3.1.1 <i>Transition Type</i>	14
3.1.2 <i>Transition Speed</i>	14
3.1.3 <i>Wipe Effect</i>	15
3.1.4 <i>WIPE Border Size</i>	15
3.1.5 <i>WIPE Border Color</i>	15
3.1.6 <i>BKG Color</i>	15
3.2 PIP / SPLIT	15
3.2.1 <i>PIP Source</i>	16
3.2.2 <i>PIP Size (PIP Window Size)</i>	16
3.2.3 <i>Position X</i>	17
3.2.4 <i>Position Y</i>	17
3.2.5 <i>Split Source</i>	17
3.2.6 <i>Border Size</i>	17
3.2.7 <i>Border Color</i>	17
3.3 PIP CROP	17
3.4 LUMAKEY	18
3.4.1 <i>Lumakey Source</i>	18
3.4.2 <i>Mode</i>	18
3.4.3 <i>Cleanup Level</i>	18
3.4.4 <i>Transparency</i>	19
3.5 AUDIO	19
3.5.1 <i>Mute</i>	19
3.5.2 <i>HDMI Input</i>	19
3.5.3 <i>HDMI Group</i>	19
3.5.4 <i>Level</i>	19
3.5.5 <i>Tally Mode</i>	19
3.6 USER MEMS	20
3.6.1 <i>Load Memory</i>	20
3.6.2 <i>Save Memory</i>	20
3.7 SETUP.....	20
3.7.1 <i>PGM Out Res</i>	21

3.7.2	<i>MV Out Res.</i>	21
3.7.3	<i>Save Setup</i>	22
3.7.4	<i>Factory Default</i>	22
3.7.5	<i>Language</i>	22
3.7.6	<i>MB and KBD Software</i>	22
CHAPTER 4	APPLICATIONS	23
4.1	PLACING A LOGO ON THE VIDEO USING THE LUMAKEY FUNCTION	23
CHAPTER 5	APPENDICES	24
APPENDIX 1	TALLY OUTPUTS	24
APPENDIX 2	FIRMWARE UPGRADE.....	25
APPENDIX 3	FREQUENTLY-ASKED QUESTIONS.....	27
APPENDIX 4	DIMENSIONS	28
APPENDIX 5	SPECIFICATIONS	29
SERVICE AND SUPPORT	30

Disclaimer of Product & Services

The information offered in this instruction manual is intended as a guide only. At all times, Datavideo Technologies will try to give correct, complete and suitable information. However, Datavideo Technologies cannot exclude that some information in this manual, from time to time, may not be correct or may be incomplete. This manual may contain typing errors, omissions or incorrect information. Datavideo Technologies always recommend that you double check the information in this document for accuracy before making any purchase decision or using the product. Datavideo Technologies is not responsible for any omissions or errors, or for any subsequent loss or damage caused by using the information contained within this manual. Further advice on the content of this manual or on the product can be obtained by contacting your local Datavideo Office or dealer.

FCC Compliance Statement

This device complies with part 15 of the FCC rules. Operation is subject to the following two conditions:

- (1) This device may not cause harmful interference, and
- (2) This device must accept any interference received, including interference that may cause undesired operation.

Warnings and Precautions

1. Read all of these warnings and save them for later reference.
2. Follow all warnings and instructions marked on this unit.
3. Unplug this unit from the wall outlet before cleaning. Do not use liquid or aerosol cleaners. Use a damp cloth for cleaning.
4. Do not use this unit in or near water.
5. Do not place this unit on an unstable cart, stand, or table. The unit may fall, causing serious damage.
6. Slots and openings on the cabinet top, back, and bottom are provided for ventilation. To ensure safe and reliable operation of this unit, and to protect it from overheating, do not block or cover these openings. Do not place this unit on a bed, sofa, rug, or similar surface, as the ventilation openings on the bottom of the cabinet will be blocked. This unit should never be placed near or over a heat register or radiator. This unit should not be placed in a built-in installation unless proper ventilation is provided.
7. This product should only be operated from the type of power source indicated on the marking label of the AC adapter. If you are not sure of the type of power available, consult your Datavideo dealer or your local power company.
8. Do not allow anything to rest on the power cord. Do not locate this unit where the power cord will be walked on, rolled over, or otherwise stressed.
9. If an extension cord must be used with this unit, make sure that the total of the ampere ratings on the products plugged into the extension cord do not exceed the extension cord rating.
10. Make sure that the total amperes of all the units that are plugged into a single wall outlet do not exceed 15 amperes.
11. Never push objects of any kind into this unit through the cabinet ventilation slots, as they may touch dangerous voltage points or short out parts that could result in risk of fire or electric shock. Never spill liquid of any kind onto or into this unit.
12. Except as specifically explained elsewhere in this manual, do not attempt to service this product yourself. Opening or removing covers that are marked "Do Not Remove" may expose you to dangerous voltage points or other risks, and will void your warranty. Refer all service issues to qualified service personnel.
13. Unplug this product from the wall outlet and refer to qualified service personnel under the following conditions:
 - a. When the power cord is damaged or frayed;
 - b. When liquid has spilled into the unit;
 - c. When the product has been exposed to rain or water;
 - d. When the product does not operate normally under normal operating conditions. Adjust only those controls that are covered by the operating instructions in this manual; improper adjustment of other controls may result in damage to the unit and may often require extensive work by a qualified technician to restore the unit to normal operation;
 - e. When the product has been dropped or the cabinet has been damaged;
 - f. When the product exhibits a distinct change in performance, indicating a need for service.



Warranty

Standard Warranty

- Datavideo equipment are guaranteed against any manufacturing defects for one year from the date of purchase.
- The original purchase invoice or other documentary evidence should be supplied at the time of any request for repair under warranty.
- The product warranty period begins on the purchase date. If the purchase date is unknown, the product warranty period begins on the thirtieth day after shipment from a Datavideo office.
- Damage caused by accident, misuse, unauthorized repairs, sand, grit or water is not covered under warranty.
- Viruses and malware infections on the computer systems are not covered under warranty.
- Any errors that are caused by unauthorized third-party software installations, which are not required by our computer systems, are not covered under warranty.
- All mail or transportation costs including insurance are at the expense of the owner.
- All other claims of any nature are not covered.
- Cables and batteries are not covered under warranty.
- Warranty only valid in the country or region of purchase.
- Your statutory rights are not affected.

Three Year Warranty

- All Datavideo products purchased after July 1st, 2017 are qualified for a free two years extension to the standard warranty, providing the product is registered with Datavideo within 30 days of purchase.
- Certain parts with limited lifetime expectancy such as LCD panels, DVD drives, Hard Drive, Solid State Drive, SD Card, USB Thumb Drive, Lighting, Camera module, PCIe Card are covered for 1 year.
- The three-year warranty must be registered on Datavideo's official website or with your local Datavideo office or one of its authorized distributors within 30 days of purchase.



Disposal

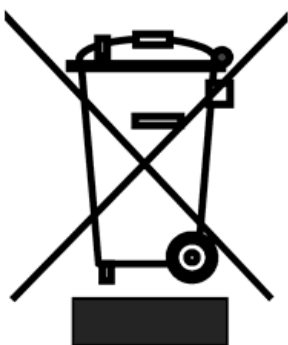

For EU Customers only - WEEE Marking

This symbol on the product or on its packaging indicates that this product must not be disposed of with your other household waste. Instead, it is your responsibility to dispose of your waste equipment by handing it over to a designated collection point for the recycling of waste electrical and electronic equipment. The separate collection and recycling of your waste equipment at the time of disposal will help to conserve natural resources and ensure that it is recycled in a manner that protects human health and the environment. For more information about where you can drop off your

waste equipment for recycling, please contact your local city office, your household waste disposal service or the shop where you purchased the product.



CE Marking is the symbol as shown on the left of this page. The letters "CE" are the abbreviation of French phrase "Conformité Européene" which literally means "European Conformity". The term initially used was "EC Mark" and it was officially replaced by "CE Marking" in the Directive 93/68/EEC in 1993. "CE Marking" is now used in all EU official documents.

Chapter 1 Introduction

The datavideo SE-500HD is a small, cost-effective, HD/SD digital video switcher with easy-to-use professional features. It offers 4 HDMI inputs and 2 HDMI outputs, supporting video formats up to Full HD 1080p.

The SE-500HD also features an audio mixer with microphone, unbalance RCA audio inputs and RCA audio outputs. More features include Luma Keyer, PIP, Wipe Generator, Still stores and Tally.

1.1 Features

- Supports up to Full HD 1080p
- 4 video Input: HDMI x 4
- 2 Video Output: HDMI x 2
- Audio input: Stereo RCA (L/R) x 1 + Microphone x 2
- Audio Output: Stereo RCA (L/R) x 1 + Stereo headphone mini Jack x 1
- Audio Mixer: MIC x 2 + Stereo x 1 + Internal digital embedded x 1
- Wipe, Mix & Simple Cut Transitions
- Support Luma Keyer
- Picture-in-picture and split functions
- Tally Output

1.2 System Diagram

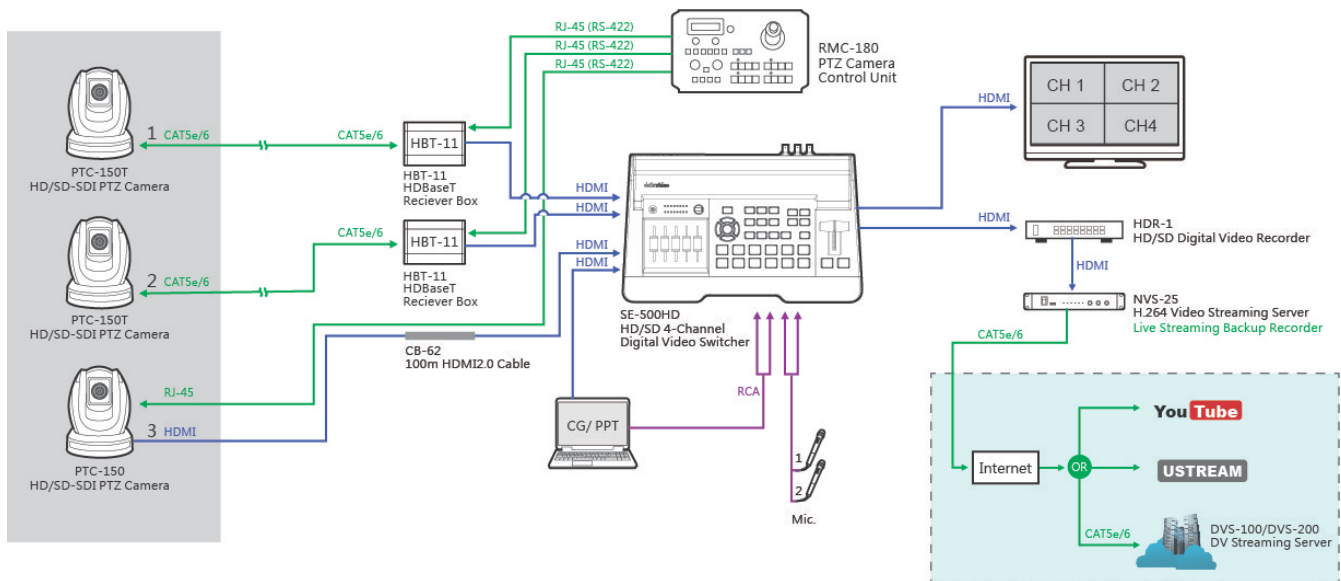

Chapter 2 Connections and Controls

2.1 Rear Panel

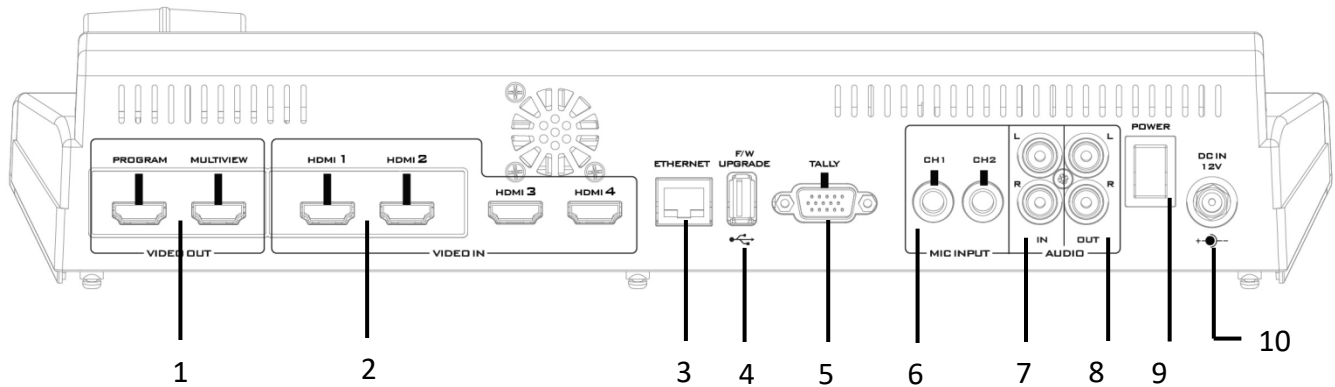

1	HDMI Video Output (Program / Multiview)	6	MIC IN – CH1/CH2
2	HDMI Video Input 1-4	7	Audio Input – Stereo RCA (Left/Right)
3	Ethernet Port	8	Audio Output – Stereo RCA (Left/Right)
4	USB F/W Upgrade Port	9	Power Switch
5	TALLY Output Port	10	DC IN

	<p>1. HDMI Video Output – Program / Multiview The SE-500HD provides two HDMI video output channels which can be connected to HDMI video display. Program is user assignable program output and Multiview outputs quad view of the four HDMI inputs.</p>
	<p>2. HDMI Video Input 1-4 The SE-500HD provides four HDMI video input channels for connecting HDMI video sources.</p>
	<p>3. Ethernet Port Remote control feature under development</p>
	<p>4. USB F/W Upgrade Port USB port for firmware upgrade. Please refer to the Firmware Upgrade section for the procedure.</p>
	<p>5. TALLY Output Port Sends Red, and Green tally signals to each channel. Red indicates On-Air, and Green indicates next camera source. Tally output port can connect other Datavideo peripheral devices such as ITC-100, ITC-200, AM-100 or</p>

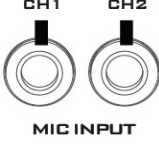
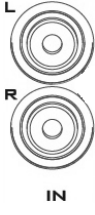
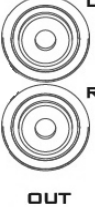
	<p>other monitor models, allowing the peripheral device to communicate with the SE-500HD or send tally signal to be displayed on the monitor.</p>															
 <p>CH1 CH2 MIC INPUT</p>	<p>6. MIC IN – CH1/CH2 Two Channels of unbalanced MIC input.</p> <table border="1" data-bbox="678 369 1460 1310"> <thead> <tr> <th>CH 1 (L)</th> <th>CH 2 (R)</th> <th>States</th> </tr> </thead> <tbody> <tr> <td>MIC1</td> <td>MIC2</td> <td>MIC 1(L) and MIC 2(R) are respectively connected to left (CH 1) and right (CH 2) channels.</td> </tr> <tr> <td>MIC1</td> <td>NC</td> <td>When MIC 1 is connected to the left channel (CH 1) and MIC 2 is not connected to the right channel (CH 2), the right channel (CH 2) switch will replicate MIC 1 signal onto the right channel (CH 2) thus both channels are MIC 1 input signals.</td> </tr> <tr> <td>NC</td> <td>MIC2</td> <td>When no MIC signal is connected to the left channel (CH 1) and only MIC 2 is connected to the right channel (CH 2), MIC 2 signal will not be replicated onto the left channel (CH 1) which will thus be grounded.</td> </tr> <tr> <td>NC</td> <td>NC</td> <td>When no MIC is connected to the two channels, the left channel (CH 1) switch will ground the left channel (CH 1) to prevent noise from being generated.</td> </tr> </tbody> </table> <p>*NC – Not Connected</p>	CH 1 (L)	CH 2 (R)	States	MIC1	MIC2	MIC 1(L) and MIC 2(R) are respectively connected to left (CH 1) and right (CH 2) channels.	MIC1	NC	When MIC 1 is connected to the left channel (CH 1) and MIC 2 is not connected to the right channel (CH 2), the right channel (CH 2) switch will replicate MIC 1 signal onto the right channel (CH 2) thus both channels are MIC 1 input signals.	NC	MIC2	When no MIC signal is connected to the left channel (CH 1) and only MIC 2 is connected to the right channel (CH 2), MIC 2 signal will not be replicated onto the left channel (CH 1) which will thus be grounded.	NC	NC	When no MIC is connected to the two channels, the left channel (CH 1) switch will ground the left channel (CH 1) to prevent noise from being generated.
CH 1 (L)	CH 2 (R)	States														
MIC1	MIC2	MIC 1(L) and MIC 2(R) are respectively connected to left (CH 1) and right (CH 2) channels.														
MIC1	NC	When MIC 1 is connected to the left channel (CH 1) and MIC 2 is not connected to the right channel (CH 2), the right channel (CH 2) switch will replicate MIC 1 signal onto the right channel (CH 2) thus both channels are MIC 1 input signals.														
NC	MIC2	When no MIC signal is connected to the left channel (CH 1) and only MIC 2 is connected to the right channel (CH 2), MIC 2 signal will not be replicated onto the left channel (CH 1) which will thus be grounded.														
NC	NC	When no MIC is connected to the two channels, the left channel (CH 1) switch will ground the left channel (CH 1) to prevent noise from being generated.														
 <p>L R IN</p>	<p>7. Audio Input – Stereo RCA (Left/Right) Connects unbalanced analog audio source (stereo) for streaming and recording.</p>															
 <p>L R OUT</p>	<p>8. Audio Output – Stereo RCA (Left/Right) Unbalanced analog audio output (stereo) for monitoring the selected audio input source.</p>															

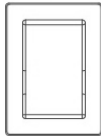
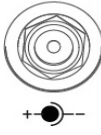
<p>POWER</p> 	<p>9. Power Switch Power switch ON/OFF</p>
<p>DC IN 12V</p> 	<p>10. DC IN DC in socket connects the supplied 12V / 19W PSU. The connection can be secured by screwing the outer fastening ring of the DC In plug to the socket.</p>



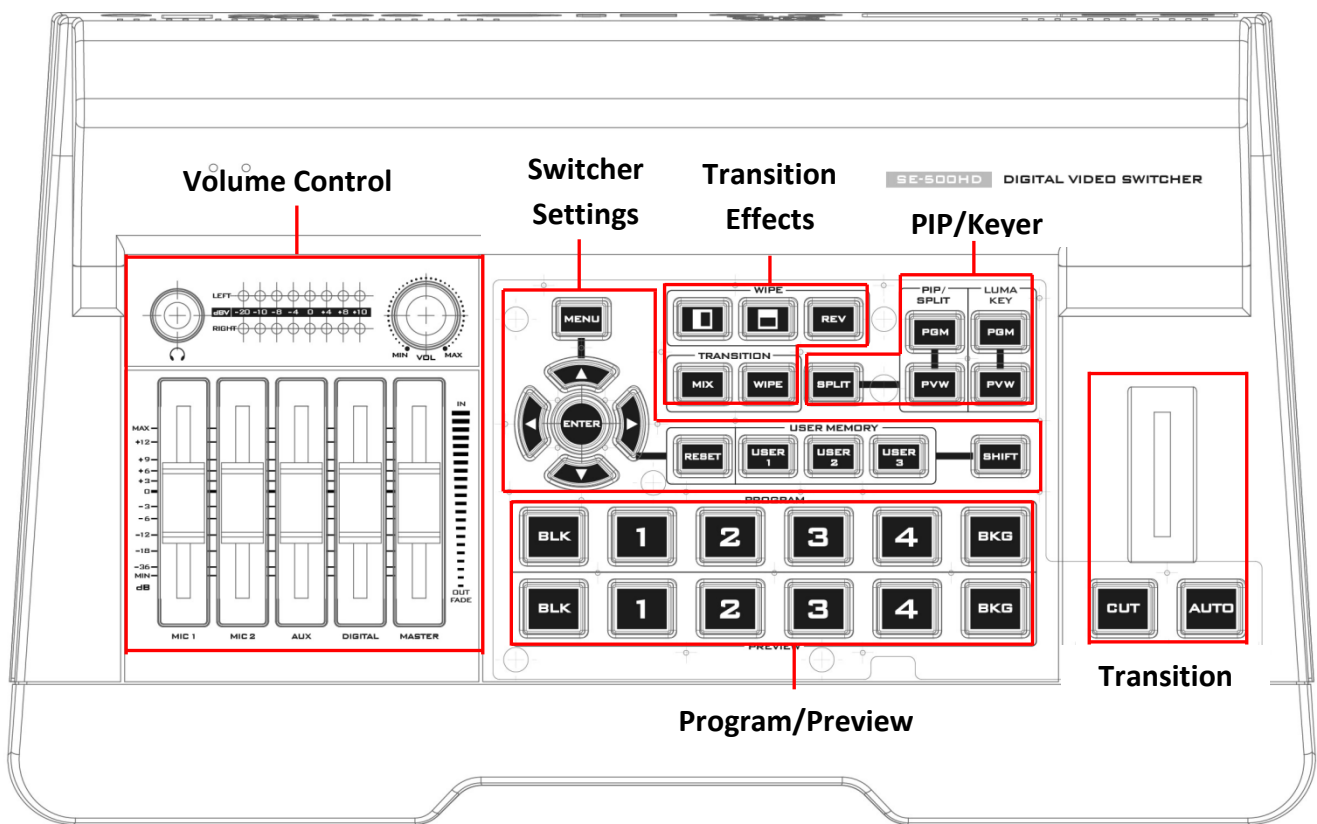

2.2 Front Panel



Switcher Settings		Transition Methods	
1	Menu browsing buttons	11	T-Bar (manual transition)
2	RESET button	12	CUT button
3	User Memory	13	AUTO transition button
4	Shift button	Program/Preview	
Transition Effects		14	Program row
5	WIPE transition effect selection	15	Preview row
6	MIX Enable/Disable button	Volume Control	
7	WIPE transition effect Enable/Disable	16	Volume adjustment sliders
PIP/Keyer		17	Headphone jack
8	Enable/Disable buttons for PIP	18	Audio meter

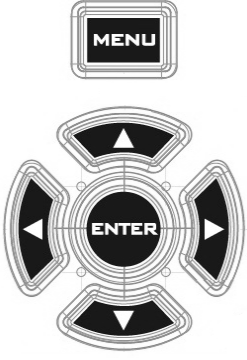



9	Luma Keyer Enable/Disable buttons	19	Headphone volume control knob
10	Split selection button		

Switcher Settings

	<p>Menu browsing buttons</p> <p>Press the MENU button to gain access to the menu; use the up/down/left/right arrow buttons to browse through the menu and press ENTER button to select an option or MENU button again to exit.</p>
	<p>Reset Button</p> <p>Mode 1 - When in Menu Select mode (left hand column of the OSD menu), pressing the 'Reset' button will reset all current menu items to their factory defaults.</p> <p>Mode 2 - When in a Sub-Menu, pressing the 'Reset' button will reset the current menu line only.</p>
<p style="text-align: center; margin-bottom: 5px;">— USER MEMORY —</p> 	<p>User Memory</p> <p>User Memory buttons 1-3 allow the user to quickly recall and load previously saved switcher settings with a single button press. This includes PIP and Keyer settings. See the User Memory section for more information.</p>
	<p>Shift Button</p> <p>Pressing the Shift button will switch USER 1-3 buttons to act as USER 4-6 buttons</p>

Transition Effects

<p style="text-align: center; margin-bottom: 5px;">— WIPE —</p> 	<p>WIPE Transition Effect Selection</p> <p>Each Wipe button consists of black and white colors. The white represents the current Program image and the black represents the WIPE-IN image. There are a total of 3 WIPE presets offered on the SE-500HD; the WIPE buttons allow the user to make a selection directly from the control panel for the first 2 which are horizontal and vertical wipes. Center WIPE can be selected from the menu (Start).</p> <p>Pressing the REV button reverses the direction of the WIPE.</p>
---	---

	<p>MIX Enable/Disable button</p> <p>A MIX, also known as a dissolve, is a transition wherein the Program video is replaced by the Preview video at a smooth rate, and at the same time. Pressing the MIX button will enable the MIX transition effect and automatically disable the WIPE button. To activate the MIX effect, simply press the AUTO button or move the T-Bar.</p>
	<p>WIPE Transition Effect Enable/Disable button</p> <p>Pressing the WIPE button enables the WIPE transition effect. After that, the WIPE transition effect can be selected. To trigger the WIPE transition effect, simply press the AUTO button or move the T-Bar.</p> <p>Wipe transition effect selection, border and position can be configured in the OSD menu (Start).</p>
PIP / Keyer	
<p style="text-align: center;">— PIP / SPLIT</p> 	<p>Enable/Disable buttons for PIP Keyer</p> <p>Picture in Picture puts the selected Sub Video Source in a window on the Main Program view, with control over window size and placement. For PIP configuration, please refer to the PIP section.</p> <p>PIP PGM: Shows the configured PIP on the PGM output after transition, however, the PIP cannot be previewed on the QUAD split view display.</p> <p>PIP PVW: Sets the configured PIP on the next transition. Holding down this button allows selection of the PIP source from the Preview Source row. The selected source button will flash.</p>
<p style="text-align: center;">— LUMA KEY</p> 	<p>Luma Keyer Enable/Disable buttons</p> <p>Luma Key PGM: Shows the luma key source on the PGM output and enables the luma key effect, however, the luma key effect cannot be previewed on the QUAD split view display.</p> <p>Luma Key PVW: Enables luma key source for the PGM output on the next transition. Holding down this button allows selection of the luma key source from the Preview Source row. The selected source button will flash.</p> <p>Please refer to the Luma Key section for luma key configurations.</p>

**Split Activation Button**

After the PIP window is activated, pressing the **Split** button will split the PROGRAM output display into two with the program out view on the left and the PIP view on the right.

To select the Split source, i.e. the program out view, please see [section 3.2.5](#).

Transition Methods**T-Bar (Manual Transition)**

T-Bar is used for performing a transition manually. The **T-Bar** can be either all the way up, all the way down or anywhere in between. When the T-Bar is pushed to halfway between the topmost position and the bottommost position, the keyboard functions will be disabled.

PVW and **PGM** views can be transitioned at your preferred speed. To include the transition effect, simply press the **WIPE** or **MIX** button, after which the **Transition Effect** will be triggered as you move the **T-Bar**.

**CUT button**

Pressing the **Cut** button performs immediate manual switch between PVW and PGM views without any transition effect.

**AUTO button**

Pressing the **Auto** button automatically transitions **PVW** and **PGM** views according to the selected speed and the configured transition effect.

Program / Preview Outputs**Program Source Row**

Pressing the number buttons along the **PROGRAM** row selects a video source for the **PGM** view.

BKG button: Pressing the **BKG** button will switch the background to the **Matte** background or color bars.

BLK button: Pressing the **BLK** button places a black screen on the monitor.



Preview Source Row

Pressing the number buttons along the **PREVIEW** row selects a video source.

BKG button: Pressing the **BKG** button will switch the background to the **Matte** background or color bars.

BLK button: Pressing the **BLK** button places a black screen on the monitor.

Volume Control

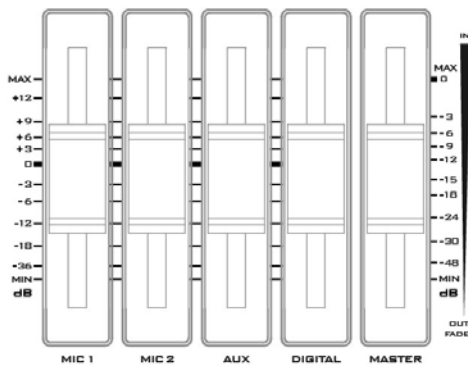

Volume Adjustment Sliders

Sliders to control audio levels for the Main audio mixer.

- MIC 1:** Unbalanced MIC IN
- MIC 2:** Unbalanced MIC IN
- AUX:** RCA audio input (analog)
- Digital:** HDMI audio input (digital)
- Master:** Main audio output

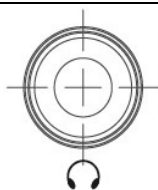

Headphone Jack

Headphones jack accepts a stereo mini jack plug for stereo headphones. The headphone volume is controlled by the Headphone volume control knob.

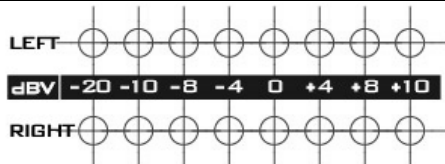

Audio Meters

LED style meters, which show the signal strength at the Main Program Audio Output. The signal measured is determined by the level set with the Master slider. The LEDs turn red at +10 dB to indicate clipping distortion.

Audio Volume (dBV)	-20	-10	-8	-4	0	4	8	10							
LED Color	G	G	G	G	G	Y	Y	R							
Range (dBV)	-20	-12	-11	-9.5	-8.5	-6.5	-5.5	-3	-2	1	2	5.5	6.5	8	9+

G: Green Y: Yellow R: Red



Headphone Volume Control Knob

Headphone volume control knob controls Headphone level with the MIN representing the minimum volume and MAX representing the maximum volume.

Chapter 3 OSD Menu

The switcher's OSD menu allows the user to perform several configurations of image effects, such as picture-in-picture, luma key and etc. The user can also configure the audio settings in the Audio option. In addition, in the setup option, the user is allowed to set video output resolution, reset to factory default, and selects the interface language.

3.1 Start

Option	Parameters	Parameter Value or Range	Default Value
Start	Transition Type	MIX WIPE	Mix
	Transition Speed	1-200 frames	60 frames; the duration in second depends on the Program OUT resolution.
	WIPE Effect	1. Horizontal 2. Vertical 3. Center	1
	WIPE Border Size	OFF Small Middle Large	Small
	WIPE Border Color	White Yellow Cyan Green Magenta Red Blue Black	Red
	BKG Color	White Yellow Cyan Green Magenta Red Blue Black	White

3.1.1 Transition Type

The SE-500HD provides two types of transition effect, which are cross dissolve (MIX) and WIPE. The default setting is MIX.

3.1.2 Transition Speed

The **Transition Speed** allows the user to set the **MIX** or **WIPE** effect duration, in frames. If the **Transition Speed** is set to a value of 60 then the transition will take effect over a period of 1 second if the progressive video is chosen and 2 seconds if the interlaced video is chosen. When the **AUTO** button is pressed, the transition will take the current **Transition Speed** defined by the user.

Note: Pressing the left or right arrow button on the control panel allows the user to either decrement or increment Position X by 1. To change the parameter value at an accelerated rate, simply press and hold the left or right arrow button.

3.1.3 Wipe Effect

On the SE-500HD, there are three wipe effects available for the user to choose. The three wipe effects are **HORIZONTAL**, **VERTICAL** and **CENTER**. The default is Horizontal.

3.1.4 WIPE Border Size

The **WIPE Border Size** generally allows the user to select an appropriate border width. Setting the **WIPE Border Size** to OFF turns the border off. Setting this parameter to small selects a thin border; middle will yield a medium size width; large is the maximum wipe border width.

3.1.5 WIPE Border Color

In this option, you will be allowed to select a color for your wipe border. The available colors are listed as follows:

- White
- Yellow
- Cyan
- Green
- Magenta
- Red Blue
- Black

3.1.6 BKG Color

In this option, you will be allowed to assign a color to the **BKG** button. The available colors are listed as follows:

- White
- Yellow
- Cyan
- Green
- Magenta
- Red Blue
- Black

3.2 PIP / Split

Picture-In-Picture (P-In-P) places a sub window on the **PGM** or **Multiview** screen. This option (**PIP/Split**) allows you to configure various parameters of the PIP window.

Note: When PIP and Lumakey features are enabled at the same time, the lumakey source will be the upper layer and the PIP source will be the lower layer. The layer order cannot be changed.

Option	Parameters	Parameter Value or Range	Default Value
PIP/Split	PIP Source	Black Input 1 Input 2	Input 2

		Input 3 Input 4 Background Color Bar	
	PIP Size	1-100%	30%
	Position X	-50% - +50%	20%
	Position Y	-50% - +50%	10%
	Split Source	Black Input 1 Input 2 Input 3 Input 4 Background Color Bar	Input 2
	Border Size	OFF Small Middle Large	Small
	Border Color	White Yellow Cyan Green Magenta Red Blue Black	Red

3.2.1 PIP Source

In this option, the user will be allowed to assign the PIP source; the available sources are listed as follows:

- Black
- Input 1
- Input 2
- Input 3
- Input 4
- Background
- Color Bar

Tip: To quickly assign the PIP source, simply press and hold the PIP PGM button and then select a source from the Program BUS.

3.2.2 PIP Size (PIP Window Size)

The PIP Size parameter ranges from 1 to 100 with 1% being the smallest and 100 being the largest. Therefore 50% would represent a PIP window which is half the size of the background image. 100% would see the PIP window totally cover the background image unless offset to one side.

3.2.3 Position X

Adjusting **Position X** parameter moves the PIP window horizontally. Pressing the left or right arrow button on the control panel allows the user to either decrement or increment **Position X** by 1. To change the parameter value at an accelerated rate, simply press and hold the left or right arrow button.

3.2.4 Position Y

Adjusting **Position Y** parameter moves the PIP window vertically. Pressing the up or down arrow button allows the user to either increment or decrement **Position Y** by 10. Press and hold the up and down arrow buttons to change the parameter value at an accelerated rate.

3.2.5 Split Source

After the PIP window is activated, pressing the Split button will split the PROGRAM output display into two with the program out view on the left and the PIP view on the right. The Split source, i.e. the program out view, can be selected in this option. The available split sources are listed as follows:

- Black
- Input 1
- Input 2
- Input 3
- Input 4
- Background
- Color Bar

3.2.6 Border Size

The **Border Size** generally allows the user to select an appropriate PIP border width. Setting the **Border Size** to OFF turns the PIP border off. Setting this parameter to small selects a thin border; middle will yield a medium size width; large is the maximum PIP border width.

3.2.7 Border Color

The user is allowed to assign a PIP border color. The available colors are listed as follows:

- White
- Yellow
- Cyan
- Green
- Magenta
- Red
- Blue
- Black

3.3 PIP Crop

The PIP Crop basically adjusts the PIP window borders. You can adjust each side individually (Left / Right / Top / Bottom) or all four sides at the same time (Size).

Option	Parameters	Parameter Value or Range	Default Value
PIP Crop	Size	0 – 100%	0
	Left	0 – 100%	0

	Right	0 – 100%	0
	Top	0 – 100%	0
	Bottom	0 – 100%	0

The effects of all parameters are described below:

- **Left** – Adjusts the position of the left edge of the PIP window.
- **Right** – Adjusts the position of the right edge of the PIP window.
- **Size** – Adjusts the PIP image crop size.
- **Top** – Adjusts the position of the top edge of the PIP window.
- **Bot** – Adjusts the position of the bottom edge of the PIP window.

3.4 Lumakey

Keyer of the SE-500HD provides the user with the capability of luma keying.

Note: When PIP and Lumakey features are enabled at the same time, the lumakey source will be the upper layer and the PIP source will be the lower layer. The layer order cannot be changed.

Option	Parameters	Parameter Value or Range	Default Value
Lumakey	Lumakey Source	Black Input 1 Input 2 Input 3 Input 4 Background Color Bar	Input 2
	Mode	Black White	Black
	Cleanup Level	0 – 100	20
	Transparency	0 – 64	64

3.4.1 Lumakey Source

Lumakey source is where you can select the image for luma keying. The available sources are listed as follows:

- Black
- Input 1
- Input 2
- Input 3
- Input 4
- Background
- Color Bar

3.4.2 Mode

There are two modes available on the Luma Keyer. Select Black if the image is on a black background and white if the image is on a white background.

3.4.3 Cleanup Level

The **Cleanup Level** allows the user to fine tune the effect of the luma key. The default value is 20.

3.4.4 Transparency

In this option, you will be able to adjust the transparency of the overall foreground key image.

3.5 Audio

This option allows the user to configure various audio settings such as muting HDMI output audio, set the audio type, selecting your tally type and etc.

Option	Parameters	Parameter Value or Range	Default Value
Audio	Mute	OFF/ON	Off
	HDMI Input	Input 1-4 / Follow	Follow
	HDMI Group	Channel 1/2 Channel 3/4 Channel 5/6 Channel 7/8	Channel 1/2
	Level	Auto / SMPTE / EBU	Auto
	Tally Mode	Normal / Audio Mixer	Normal

3.5.1 Mute

The **Mute** allows you to turn ON/OFF the embedded audio component at the **HDMI-in**. The default is OFF.

3.5.2 HDMI Input

In this option, you can select the audio source. Selection of input 1-4 allows the SE-500HD to play the enabled audio source. If “**Follow**” is selected, the audio will enter Audio follow Video mode, i.e. playback of the audio of the output video.

3.5.3 HDMI Group

The HDMI Group allows the user to assign the HDMI audio channel. The default audio channel is Channel 1/2. Any audio channel pair of the four audio channel pairs can be selected.

3.5.4 Level

There are two different audio standards available for selection. The user can either select the EBU or SMPTE standard. By selecting AUTO allows the device to automatically detect the audio standard. When the image is 50 Hz, the audio follows EBU standard and when the image is 59.94/60 Hz, the audio follows SMPTE standard.

3.5.5 Tally Mode

Tally output port generally sends two tally signals to each channel. In Datavideo products, **Red** indicates On-Air, and **Green** indicates next camera source.

The SE-500HD provides **two tally modes**:

Normal: If in normal mode, tally lights of all camera sources displayed on the PGM monitor will be turned ON (Red). These sources include PGM, PIP and Key sources. While transition is in progress, the next video will be seen on the PGM monitor, tally light of the PVW source camera will thus also be turned ON (**Red**).

Audio Mixer: If Audio Mixer mode is selected, tally light of the PGM source camera selected on the keyboard panel will be turned ON (Red). While transition is in progress, the tally light color will remain unchanged. The tally light color will only change (red/green) after the transition of PGM and PVW views is complete.

3.6 User Mems

In “User Mems”, the user is allowed to **load** previously saved settings and **save** the currently configured settings.

Option	Parameters	Parameter Value or Range	Default Value
User Mems	Load Memory	User 1-6	
	Load		
	Save Memory	User 1-6	
	Save		

3.6.1 Load Memory

Use the up/down arrow to select the desired memory location and load the saved setting by selecting “Load”.

Tip: The user can also press one of the USER memory shortcut buttons (1-3) on the control panel as a quick way of loading those previously saved User configurations. Use the **SHIFT** button to switch between **USER MEMORY 1-3** and **USER MEMORY 4-6**.

3.6.2 Save Memory

Use the up/down arrow to select the desired memory location and save the current setting by selecting “Save”.

3.7 Setup

In the “Setup” menu, the user can change the **output resolution**, reset the SE-500HD to its **Factory Default** values, choose the preferred OSD menu **language**, **upgrade firmware** and view the **current firmware versions** (Mainboard and Keyboard).

Option	Parameters	Parameter Value or Range	Default Value
Setup	PGM Out Res.	1080p/60 1080p/59.94 1080p/50 1080i/60 1080i/59.94 1080i/50 720p/60 720p/59.94 720p/50 576i 480i	
	MV Out Res.	1080p/60 1080p/59.94 1080p/50	

		1080i/60 1080i/59.94 1080i/50 720p/60 720p/59.94 720p/50	
	Save Setup	[Save]	
	Factory Default	[Reset]	
	Language	English Simplified Chinese Traditional Chinese	
	MB Software	Version	
	KBD Software	Version	

3.7.1 PGM Out Res.

In **PGM Out RES.**, the user is allowed to select an appropriate PROGRAM output resolution. The available resolutions are listed as follows:

- 1080p/60
- 1080p/59.94
- 1080p/50
- 1080i/60
- 1080i/59.94
- 1080i/50
- 720p/60
- 720p/59.94
- 720p/50
- 576i
- 480i

Once done, simply go to “**Save Setup**” to confirm the selected output resolution.

Note: Please make sure the output resolution is same as the input resolution to avoid unexpected issues from occurring.

3.7.2 MV Out Res.

In **MV Out RES.**, the user is allowed to select an appropriate MULTIVIEW output resolution. The available resolutions are listed as follows:

- 1080p/60
- 1080p/59.94
- 1080p/50
- 1080i/60
- 1080i/59.94
- 1080i/50
- 720p/60
- 720p/59.94
- 720p/50

Once done, simply go to “**Save Setup**” to confirm the selected output resolution.

Note: The new resolution will be effective once selected. If you have selected a resolution that is not supported by the monitor, you will not be able to view the OSD menu. In this case, please reboot your machine to restore the default resolution previously configured in the “Save Setup” option.

3.7.3 Save Setup

In this option, select “**Save**” to save the current configuration.

3.7.4 Factory Default

Reset: Once selected, the factory default settings will be restored. The device will start the factory reset process in 2 to 3 seconds after “**Reset**” is selected.

3.7.5 Language

The available OSD menu languages are English, Traditional Chinese and Simplified Chinese.

3.7.6 MB and KBD Software

The MB and KBD software versions will be respectively displayed.

Chapter 4 Applications

4.1 Placing a logo on the video using the lumakey function

The SE-500HD allows the user to place a logo on the video using the lumakey function. First of all, create a 1920x1080 (16:9) logo against a black or white background on a laptop. Once the logo is created, please follow the steps outlined as follows to insert the logo layer.

Note: If the logo is dark, choose a white background; if the logo consists primarily of bright colors, choose a black background.

1. Connect the laptop to one of the switcher's **HDMI Input Ports**, HDMI Input 2 for example.
2. Press the **MENU** button to open the OSD Menu on the four-quadrant Multiview display.
3. In the **Lumakey** option, set the "**Lumakey Source**" to **Input 2**.
4. In this example, the logo is against a black background so **Black Mode** is chosen.
5. Set the "**Cleanup Level**" to 10 if the background is in total black.
6. "**Transparency**" is set to 64 if an opaque logo is desired. **Opaque** logo can be created by setting the "**Transparency**" parameter to 64. **Semi-transparency** effect can be generated by setting the "**Transparency**" parameter to a value between 0 and 64.
7. Exit the menu after the Logo is properly configured.
8. Press the **Luma Key PGM** button to place the logo on the Program screen or the **Luma Key PVW** button to place the logo on the Preview screen.

Chapter 5 Appendices

Appendix 1 Tally Outputs

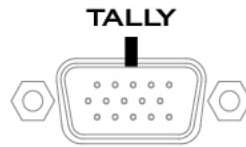

The SE-500HD has a D-sub 15 pin female tally output port. These connections provide bi-colour tally information to a number of other Datavideo products, such as the ITC-100 eight channel talkback system and the TLM range of LCD Monitors. The ports are open collector ports and as such do not provide power to tally light circuits.

The pin outputs are defined as follows:

PIN No.	Signal Name	Input/Output	Description of Signal
1	Program 1	Open collector output	Tally output of input video Program 1
2	--	--	No Function
3	Preview 1	Open collector output	Tally output of input video Preview 1
4	RCOM (GND)	Ground	Ground
5	Program 4	Open collector output	Tally output of input video Program 4
6	Program 2	Open collector output	Tally output of input video Program 2
7	--	--	No Function
8	Preview 2	Open collector output	Tally output of input video Preview 2
9	GND	Ground	Ground
10	--	--	No Function
11	Program 3	Open collector output	Tally output of input video Program 3
12	--	--	No Function
13	Preview 3	Open collector output	Tally output of input video Preview 3
14	YCOM (GND)	Ground	Ground
15	Preview 4	Open collector output	Tally output of input video Preview 4

Appendix 2 Firmware Upgrade

Datavideo usually releases new firmware containing new features or reported bug fixes from time to time. Customers can either download the SE-500HD firmware as they wish or contact their local dealer or reseller for assistance.

This section outlines the firmware upgrade process which should take **approximately 10 minutes to complete**. The existing SE-500HD settings should persist through the **firmware upgrade process, which should not be interrupted once started** as this could result in a non-responsive unit.

1. On the PC, copy the two SE-500HD firmware binary files to the root directory of a USB thumb drive. After the files are successfully copied, safely remove the USB thumb drive from the PC.
 - **SE-500HD.bin**: The SE-500HD Keyboard (KB) Firmware is approximately 27KB and usually with a version number of V1.X.
 - **SE-500HDM.bin**: The firmware file for the SE-500HD Mainboard (MB) and OSD MENU fonts is approximately 2-3 MB (Example of the firmware display is V1.6 for the mainboard and V1.02 for OSD fonts).
2. Connect the USB thumb drive to the F/W Upgrade USB port located on the back of the SE-500HD device.

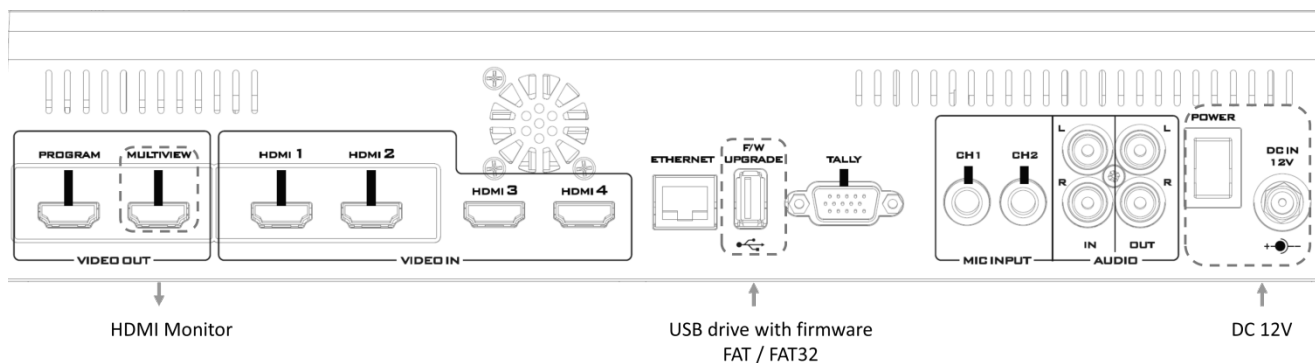

3. Connect the MULTIVIEW VIDEO OUT port to the HDMI Monitor and turn on the SE-500HD power.
4. Approximately after 5 seconds, the keyboard firmware will be updated and the update status will be indicated by the LED color of the program row buttons.
 - **Same version number** detected: The firmware will **NOT** be updated and all six buttons will be backlit red.
 - **Different version number** detected: The BLK button flashes red twice and the firmware will be updated. All six program row buttons will be backlit red while the firmware is being updated. As soon as the program row buttons are turned off and then turned back on (red) again, the firmware update is complete. The SE-500HD automatically reboots itself after the keyboard firmware is updated.
5. The Mainboard firmware is automatically updated after the Step 4 is executed and the update status will be indicated by the LED color (green) of the preview row buttons. Approximately 5 seconds after the SE-500HD is rebooted, you will see a startup screen on the monitor with old mainboard version displayed at the bottom right corner, for instance V1.5. At this point, the BLK button will start flashing green. The mainboard firmware update will start approximately 10 seconds after the mainboard finishes booting.
 - **Same version number** detected: The firmware will **NOT** be updated and all six buttons will be backlit green.
 - **Different version number** detected: The startup screen on the monitor disappears and the

firmware update will be in progress as the preview row buttons are turned on one at a time from left to right until all buttons are backlit constant green after approximately **ONE minute**. At this point, the firmware update is complete and the mainboard will reboot itself. After the SE-500HD finishes booting, the new version number will be displayed at the bottom right corner of the SE-500HD startup screen, for instance V1.6.

6. The OSD fonts will be automatically updated after the Step 5 is executed and the update status will be indicated by the LED color (green) of the preview row buttons. The machine reboots itself after the mainboard is updated, and the BLK button will start flashing green after the reboot. The OSD fonts update will start approximately 10 seconds after the mainboard finishes booting.
 - **Same version number** detected: The firmware will **NOT** be updated and all six buttons will be backlit green.
 - **Different version number** detected: The startup screen on the monitor disappears and the firmware update will be in progress as the preview row buttons are turned on one at a time from left to right until all buttons are backlit constant green after approximately **TWO minutes**. At this point, the monitor will display a four-quadrant Multiview display and this indicates that the OSD fonts update is complete.
7. The update is finished all six buttons of the program and preview rows are respectively backlit constant red and green. Remove the USB thumb drive and reboot the SE-500HD.
8. After the machine finishes booting and as soon as you see the Multiview screen, press the MENU button to open the OSD menu to check the MB, OSD and KB versions: Use the Up/Down arrow buttons to move to the Setup option and check if the firmware is successfully updated:
 - MB Software: V1.16.1.02
 - KBD Software: V1.2 (SE-500HD)

Note 1: The device will not be damaged if the USB cable or power is accidentally disconnected while the firmware is being updated; plug the USB thumb drive back in and reboot the device to continue the update process.

Note 2: The USB disk drive system supports FAT / FAT32 formats.

Note 3: There is no guarantee that the SE-500HD supports all USB disks. When you see all buttons of the program and preview rows are backlit pink or greenish pink, this indicates the disk file read error. When this occurs, please try using USB thumb drives made by other manufacturers.

Appendix 3 Frequently-Asked Questions

This section describes problems that you may encounter while using SE-500HD. If you have any questions, please refer to related sections and follow all suggested solutions. If problem still exists, please contact your distributor or the service center.

No.	Problems	Solutions
1.	Audio is switched only after the transition is complete.	It is normal that audio is switched after the transition is complete regardless of the transition method (T-Bar or Auto) used.
2.	Jitter is seen on moving images.	Please make sure the input and output are set to the same resolution and frame rate.

Appendix 4 Dimensions

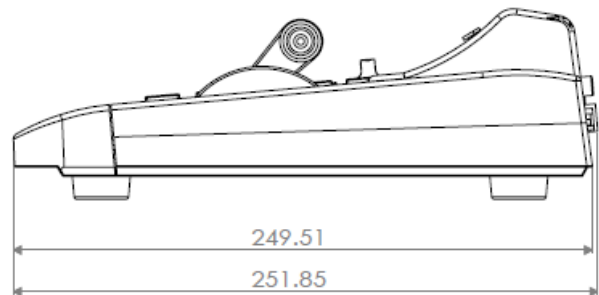
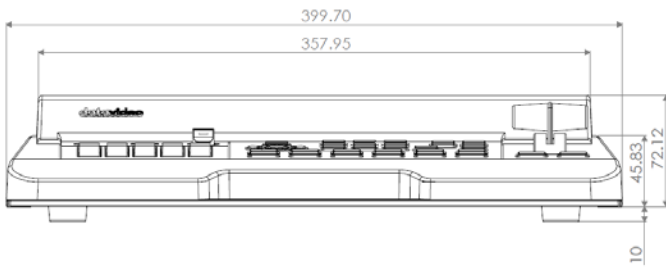
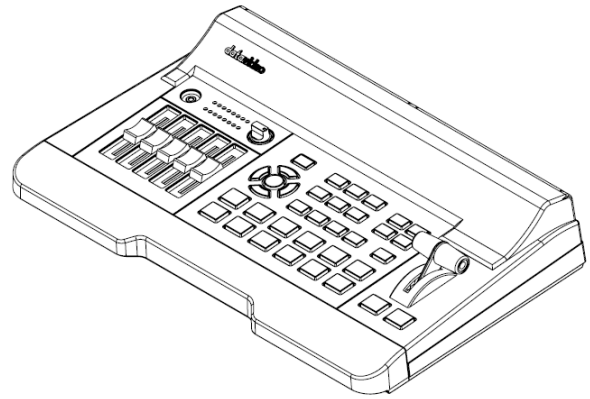
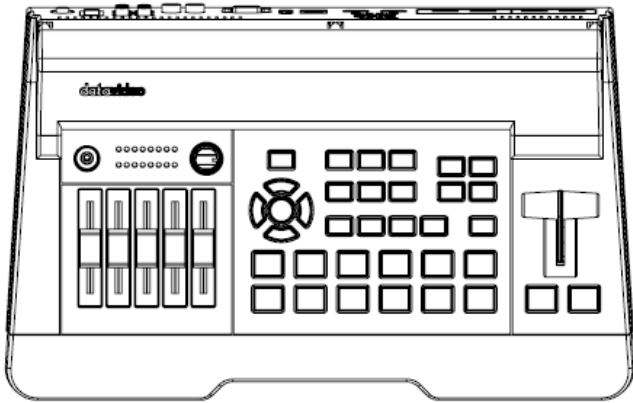

All measurements in millimeters (mm)

Appendix 5 Specifications

Interfaces	
Video Inputs	4 x HDMI (HDMI1.4)
Video Outputs	2 x HDMI (HDMI 1.4) 1 Multiview and 1 Program
Audio Inputs	1 x Stereo RCA (L/R) 2 x Mono Microphone De-embedded Digital Audio (2 CH)
Audio Outputs	1 x Stereo RCA (L/R) 1 x Stereo headphone (Mini Jack with volume control) Embedded Digital Audio (2 CH / Channel 1 & 2)
Tally	Yes / D-Sub 15 male connector
Software Update	USB Port
Audio Mixer	
Audio Fader	5 VR (Variable Resistor) 6 Channel (3 Pair) Audio Mixer
Audio LED Meter	2 Rows (Left/Right)
Standards	
Supported Input Resolution	VGA, XGA (1024 x 768), SXGA (1280 x 1024), UXGA (1600 x1200), WUXGA (1920 x 1200) 1920 x 1080p 60/59.94/50 1920 x 1080i 60/59.94/50 1280 x 720p 60/59.94/50 480i/p, 576i/p
Supported Output Resolution	1920 x 1080p 60/59.94/50 1920 x 1080i 60/59.94/50 1280 x 720p 60/59.94/50 480p, 576p
Audio Format Support	PCM LPCM 2CH 6CH 8CH
Additional	
Keyers	Luma Keyer
PIP	Yes
Split	Yes
Transition	WIPE / MIX / CUT
General	
Operating Temperature	0°C to 50°C (32°F to 122°F)
Humidity	10% to 80%

Service & Support

It is our goal to make owning and using Datavideo products a satisfying experience. Our support staff is available to assist you to set up and operate your system. Contact your local office for specific support requests. Plus, please visit www.datavideo.com to access our FAQ section.

China Shanghai
Datavideo Technologies China Co
601, Building 10, No. 1228,
Rd. Jiangchang,
Jingan District, Shanghai
Tel: +86 21-5603 6599
Fax: +86 21-5603 6770
E-mail: service@datavideo.cn

China Beijing
Datavideo Technologies China Co
No. 812, Building B, Wankai Center,
No. 316, Wan Feng Road, Fengtai District,
Beijing, China
Tel: +86 10-8586 9034
Fax: +86 10-8586 9074
E-mail: service@datavideo.cn

China Chengdu
Datavideo Technologies China Co
B-823, Meinian square, No. 1388,
Middle of Tianfu Avenue, Gaoxin District,
Chengdu, Sichuan
Tel: +86 28-8613 7786
Fax: +86 28-8513 6486
E-mail: service@datavideo.cn

China Fuzhou
Datavideo Technologies China Co
A1-2318-19 Room, No. 8, Aojiang Road,
Taijiang District, Fuzhou, Fujian, China
Tel: 0591-83211756 · 0591-83210187
Fax: 0591-83211262
E-mail: service@datavideo.cn

China Jinan
Datavideo Technologies China Co
902, No. 1 business building,
Xiangtai Square, No. 129,
Yingxiongshan Road, Shizhong District,
Jinan City, Shandong Province, China
Tel: +86 531-8607 8813
E-mail: service@datavideo.cn

Hong Kong
Datavideo Hong Kong Ltd
G/F., 26 Cross Lane
Wanchai, Hong Kong
Tel: +852-2833-1981
Fax: +852-2833-9916
E-mail: info@datavideo.com.hk

India Noida
Datavideo India Noida
A-132, Sec-63, Noida-201307,
India
Tel: +91-0120-2427337
Fax: +91-0120-2427338
E-mail: sales@datavideo.in

India Kochi
Datavideo India Kochi
2nd Floor- North Wing, Govardhan Building,
Opp. NCC Group Headquarters, Chittoor Road,
Cochin- 682035
Tel: +91 4844-025336
Fax: +91 4844-047696
E-mail: sales@datavideo.in

Netherlands
Datavideo Technologies Europe BV
Floridadreef 106
3565 AM Utrecht,
The Netherlands
Tel: +31-30-261-96-56
Fax: +31-30-261-96-57
E-mail: info@datavideo.nl

Singapore
Datavideo Visual Technology(S) Pte Ltd
No. 178 Paya Lebar Road #06-07
Singapore 409030
Tel: +65-6749 6866
Fax: +65-6749 3266
E-mail: info@datavideovirtualset.com

Singapore
Datavideo Technologies (S) PTE Ltd
No. 178 Paya Lebar Road #06-03
Singapore 409030
Tel: +65-6749 6866
Fax: +65-6749 3266
E-mail: sales@datavideo.sg

Taiwan
Datavideo Technologies Co. Ltd
10F. No. 176, Jian 1st Rd., Chung Ho
District, New Taipei City 235, Taiwan
Tel: +886-2-8227-2888
Fax: +886-2-8227-2777
E-mail: service@datavideo.com.tw

United States
Datavideo Corporation
7048 Elmer Avenue.
Whittier, CA 90602,
U.S.A.
Tel: +1-562-696 2324
Fax: +1-562-698 6930
E-mail: sales@datavideo.com

United Kingdom
Datavideo UK Limited
Brookfield House, Brookfield Industrial
Estate, Peakdale Road, Glossop,
Derbyshire, SK13 6LQ
Tel: +44-1457 851 000
Fax: +44-1457 850 964
E-mail: sales@datavideo.co.uk

France
Datavideo France s.a.r.l.
Cit  Descartes 1, rue Albert Einstein
Champs sur Marne 774477 –
Marne la Vall e cedex 2
Tel: +33-1-60370246
Fax: +33-1-60376732
E-mail: info@datavideo.fr



Please visit our website for latest manual update.
www.datavideo.com/product/SE-500HD

datavideo
www.datavideo.com