



XS-62S

HD VIDEO SWITCHER

Owner's Manual Version 2.0 and later

Before using the XS-62S, ensure that its system program is at the most recent version. For information on available upgrades for the system program, see the Roland website (<https://proav.roland.com/>).

You can check the system program version by pressing the [MENU] button → "SYSTEM" → "VERSION."

Owner's Manual (this document)

Read this first. It explains the basic things you need to know in order to use the XS-62S.

PDF Manual (download from the Web)

- **Reference Manual**

This manual covers all menu items of the XS-62S.

It also describes control via LAN CONTROL, RS-422, RS-232, and TALLY/GPIO.

To obtain the PDF manual

1. Enter the following URL in your computer.

<https://proav.roland.com/>



2. Go to the XS-62S product page and click the "Support."



For the U.K.

IMPORTANT: THE WIRES IN THIS MAINS LEAD ARE COLOURED IN ACCORDANCE WITH THE FOLLOWING CODE.

BLUE: NEUTRAL
BROWN: LIVE

As the colours of the wires in the mains lead of this apparatus may not correspond with the coloured markings identifying the terminals in your plug, proceed as follows:

The wire which is coloured BLUE must be connected to the terminal which is marked with the letter N or coloured BLACK.

The wire which is coloured BROWN must be connected to the terminal which is marked with the letter L or coloured RED.

Under no circumstances must either of the above wires be connected to the earth terminal of a three pin plug.

For the USA

FEDERAL COMMUNICATIONS COMMISSION RADIO FREQUENCY INTERFERENCE STATEMENT

This equipment has been tested and found to comply with the limits for a Class B digital device, pursuant to Part 15 of the FCC Rules. These limits are designed to provide reasonable protection against harmful interference in a residential installation. This equipment generates, uses, and can radiate radio frequency energy and, if not installed and used in accordance with the instructions, may cause harmful interference to radio communications. However, there is no guarantee that interference will not occur in a particular installation. If this equipment does cause harmful interference to radio or television reception, which can be determined by turning the equipment off and on, the user is encouraged to try to correct the interference by one or more of the following measures:

- Reorient or relocate the receiving antenna.
- Increase the separation between the equipment and receiver.
- Connect the equipment into an outlet on a circuit different from that to which the receiver is connected.
- Consult the dealer or an experienced radio/TV technician for help.

This device complies with Part 15 of the FCC Rules. Operation is subject to the following two conditions:

(1) this device may not cause harmful interference, and

(2) this device must accept any interference received, including interference that may cause undesired operation.

This equipment requires shielded interface cables in order to meet FCC class B limit.

Any unauthorized changes or modifications not expressly approved by the party responsible for compliance could void the user's authority to operate the equipment.

For Canada

CAN ICES-3 (B)/NMB-3 (B)

For Korea

사용자 안내문

기종별	사용자 안내문
B 급 기기 (가정용 방송통신기자재)	이 기기는 가정용(B 급) 전자파적합기기로서 주로 가정에서 사용하는 것을 목적으로 하며, 모든지역에서 사용할 수 있습니다.

Manufacturer: 2036-1 Nakagawa, Hosoe-cho, Kita-ku, Hamamatsu, Shizuoka 431-1304, JAPAN

Importer: ENA 23 Zone 1 nr. 1620 Klaus-Michael Kuehnelaan 13, 2440 Geel, BELGIUM



For the USA

DECLARATION OF CONFORMITY Compliance Information Statement

Model Name : XS-62S
Type of Equipment : VIDEO SWITCHER
Responsible Party : Roland Corporation U.S.
Address : 5100 S. Eastern Avenue Los Angeles, CA 90040-2938
Telephone : (323) 890-3700



Roland Service Centers and Distributors

When you need repair service, access this URL and find your nearest Roland Service Center or authorized Roland distributor in your country.

http://roland.cm/proav_service



Contents

USING THE UNIT SAFELY	4
IMPORTANT NOTES	6
Panel Descriptions	7
Front Panel	7
Connecting Your Equipment (Rear Panel / Front Panel)	8
Multi-view Monitor Display	10
Basic Operations	11
Turning the Power On and Off	11
Operating the Menu	11
Video Input/Output Settings	12
Setting the Video Input/Output Format	12
Setting the System Format	12
Checking the Video Format Being Input	12
Setting the Input Formats for Channels 5 and 6	13
Assigning a Video Source to Channel 6	13
Adjusting Output Video	14
About the HDMI OUT 3 Connector	14
Adjusting the Input Video	15
Selecting the Video of the Bus to Output	16
Inputting Copyright-protected (HDCP) Video	16
Video Operations	17
Switching the Video	17
About the Operation Mode for Video Transitions	17
Switching Using the PGM-PST Mode	17
Switching Using the DISSOLVE Mode	17
Switching Using the MATRIX Mode	18
Selecting the Channel for Output to the AUX/3 Bus	18
Switching Automatically (Auto Scan)	19
Freezing Input Video (Freeze)	19
Using Imported Still Images	19
Capturing a Still Image from Input Video	19
Importing a Still Image from a USB Flash Drive	20
Assigning Still Images to Channels 7 and 8	20
Deleting a Still Image	21
Video Composition Operations	22
Compositing Using Picture-in-Picture (PinP)	22
Compositing Using Split	23
Compositing Using DSK	24
Audio Operations	25
Adjusting the Volume Level	25
Adjusting the Head Amp Gain	25
Adjusting the Sound Position (Pan)	25
Adjusting the Volume Balance	26
Selecting the Audio of the Bus to Output	26
Applying Effects to Audio	27
Applying Effects to Input Audio	27
Applying Effects to Output Audio	28
Controlling Fader Operation Automatically (Auto Mixing)	29
Adjusting the Auto Mixing Effect	29
Silencing Specific Audio (Mute)	30
Interlinking Audio Output to Video Switching (Audio Follow)	30
Separating Discrete Analog Input Audio Streams and Adding Them to SDI Video	31
Other Features	33
Saving/Recalling Settings (Preset Memory)	33
Saving to a preset memory	33
Recalling settings	33
Saving the Unit's Settings on a USB Flash Drive	34
Formatting USB Flash Drives	35
Returning Settings to the Factory-default State (Factory Reset)	35
Preventing Unintended Operation (Panel Lock)	36
Operating the XS-62S or an External Device by Remote Control	36
Outputting a Tally Signal	37
Appendices	38
Troubleshooting	38
RGB/CMPNT/CMPST IN 6 Connector Specifications	39
Block Diagram	40
Video Section (PGM-PST Mode, DISSOLVE Mode)	40
Video Section (MATRIX Mode)	41
Audio Section	42
Transition Effects List	44
Main Specifications	45
Dimensions	47

Before using this unit, carefully read "USING THE UNIT SAFELY" (p. 4) and "IMPORTANT NOTES" (p. 6). After reading, keep the document(s) where it will be available for immediate reference.

Checking the Included Items

The XS-62S includes the following items. Please take a moment to confirm that all of these items have been included with the XS-62S. If you find that any item is missing, contact the nearest authorized Roland distributor in your country.

- The unit
- AC adaptor, Power cord
- Owner's Manual
- Rubber feet (4 pcs.)

USING THE UNIT SAFELY

INSTRUCTIONS FOR THE PREVENTION OF FIRE, ELECTRIC SHOCK, OR INJURY TO PERSONS

About ⚠ WARNING and ⚠ CAUTION Notices

⚠ WARNING	Used for instructions intended to alert the user to the risk of death or severe injury should the unit be used improperly.
⚠ CAUTION	Used for instructions intended to alert the user to the risk of injury or material damage should the unit be used improperly. * Material damage refers to damage or other adverse effects caused with respect to the home and all its furnishings, as well to domestic animals or pets.

About the Symbols

	The ⚠ symbol alerts the user to important instructions or warnings. The specific meaning of the symbol is determined by the design contained within the triangle. In the case of the symbol at left, it is used for general cautions, warnings, or alerts to danger.
	The ⚡ symbol alerts the user to items that must never be carried out (are forbidden). The specific thing that must not be done is indicated by the design contained within the circle. In the case of the symbol at left, it means that the unit must never be disassembled.
	The Ⓜ symbol alerts the user to things that must be carried out. The specific thing that must be done is indicated by the design contained within the circle. In the case of the symbol at left, it means that the power-cord plug must be unplugged from the outlet.

ALWAYS OBSERVE THE FOLLOWING

⚠ WARNING

To completely turn off power to the unit, pull out the plug from the outlet

Even with the power switch turned off, this unit is not completely separated from its main source of power. When the power needs to be completely turned off, turn off the power switch on the unit, then pull out the plug from the outlet. For this reason, the outlet into which you choose to connect the power cord's plug should be one that is within easy reach and readily accessible.



Concerning the Auto Off function

The power to this unit will be turned off automatically after a predetermined amount of time has passed since it was last used for playing music, or its buttons or controls were operated (Auto Off function). If you do not want the power to be turned off automatically, disengage the Auto Off function (p. 11).



Secure a sufficient amount of space at the setup location

Since this unit normally emits a slight amount of heat, make sure to secure sufficient space around it, as shown below.

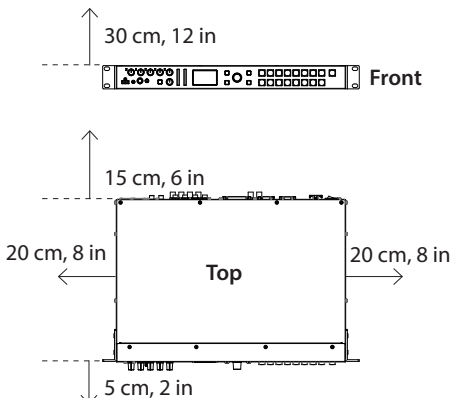

⚠ WARNING

Do not disassemble or modify by yourself

Do not carry out anything unless you are instructed to do so in the owner's manual. Otherwise, you risk causing malfunction.



Do not repair or replace parts by yourself

Refer all servicing to your retailer, the nearest Roland Service Center, or an authorized Roland distributor, as listed on the "Information."



Do not use or store in the following types of locations

- Subject to temperature extremes (e.g., direct sunlight in an enclosed vehicle, near a heating duct, on top of heat-generating equipment); or are
- Damp (e.g., baths, washrooms, on wet floors); or are
- Exposed to steam or smoke; or are
- Subject to salt exposure; or are
- Exposed to rain; or are
- Dusty or sandy; or are
- Subject to high levels of vibration and shakiness; or are
- Placed in a poorly ventilated location.



Do not place in an unstable location

Otherwise, you risk injury as the result of the unit toppling over or dropping down.



Use only the supplied AC adaptor and the correct voltage

Be sure to use only the AC adaptor supplied with the unit. Also, make sure the line voltage at the installation matches the input voltage specified on the AC adaptor's body. Other AC adaptors may use a different polarity, or be designed for a different voltage, so their use could result in damage, malfunction, or electric shock.



⚠ WARNING

Use only the supplied power cord

Use only the attached power cord. Also, the supplied power cord must not be used with any other device.



Do not bend the power cord or place heavy objects on it

Otherwise, fire or electric shock may result.



Avoid extended use at high volume

Use of the unit at high volume for extended periods of time may cause hearing loss. If you ever experience any hearing loss or ringing in the ears, you should immediately stop using the unit and consult a specialized physician.



Do not allow foreign objects or liquids to enter unit; never place containers with liquid on unit

Do not place containers containing liquid (e.g., flower vases) on this product. Never allow foreign objects (e.g., flammable objects, coins, wires) or liquids (e.g., water or juice) to enter this product. Doing so may cause short circuits, faulty operation, or other malfunctions.



Be cautious to protect children from injury

Always make sure that an adult is on hand to provide supervision and guidance when using the unit in places where children are present, or when a child will be using the unit.



Do not drop or subject to strong impact

Otherwise, you risk causing damage or malfunction.



⚠ WARNING

Turn off the unit if an abnormality or malfunction occurs

Immediately turn the unit off, remove the AC adaptor from the outlet, and request servicing by your retailer, the nearest Roland Service Center, or an authorized Roland distributor, as listed on the "Information" when:



- The AC adaptor or the power cord has been damaged; or
- If smoke or unusual odor occurs; or
- Objects have fallen into, or liquid has been spilled onto the unit; or
- The unit has been exposed to rain (or otherwise has become wet); or
- The unit does not appear to operate normally or exhibits a marked change in performance.

Do not share an outlet with an unreasonable number of other devices

Otherwise, you risk overheating or fire.



Do not use overseas

Before using the unit in overseas, consult with your retailer, the nearest Roland Service Center, or an authorized Roland distributor, as listed on the "Information."



Important Notes on Rack Mounting

When mounting the unit in a rack, to ensure efficient cooling, give attention to the following points.



- Install in a well-ventilated location.
- Never obstruct the exhaust ports on the unit's side panels.
- Avoid mounting the unit in a sealed-type rack. Warm air within the rack cannot escape and is sucked into the unit, making efficient cooling impossible.
- If the back of the rack cannot be opened, install an exhaust port or ventilation fan at the top back surface of the rack, where warm air collects.
- When using the unit while mounted in a movable case (portable rack), remove the front and rear rack covers so that the front and back of the unit are not obstructed.

When installing the unit in a rack or the like, use the mounting screws occupying the screw holes in the rack-mount brackets (included with the unit). Also, use due caution to ensure that your fingers don't get pinched.

* Also read the "Placement" section (p. 6) under "IMPORTANT NOTES."

⚠ CAUTION

When disconnecting the power cord, grasp it by the plug

To prevent conductor damage, always grasp the power cord by its plug when disconnecting it.



Periodically clean the power plug

An accumulation of dust or foreign objects between the power plug and the power outlet can lead to fire or electric shock.



At regular intervals, be sure to pull out the power plug, and using a dry cloth, wipe away any dust or foreign objects that may have accumulated.

Disconnect the power plug whenever the unit will not be used for an extended period of time

Fire may result in the unlikely event that a breakdown occurs.



Route all power cords and cables in such a way as to prevent them from getting entangled

Injury could result if someone were to trip on a cable and cause the unit to fall or topple.



Avoid climbing on top of the unit, or placing heavy objects on it

Otherwise, you risk injury as the result of the unit toppling over or dropping down.



Never connect/disconnect a power plug if your hands are wet

Otherwise, you could receive an electric shock.



Disconnect all cords/cables before moving the unit

Before moving the unit, disconnect the power plug from the outlet, and pull out all cords from external devices.



Before cleaning the unit, disconnect the power plug from the outlet

If the power plug is not removed from the outlet, you risk receiving an electric shock.



Whenever there is a threat of lightning, disconnect the power plug from the outlet

If the power plug is not removed from the outlet, you risk causing malfunction or receiving an electric shock.



Keep small items out of the reach of children

To prevent accidental ingestion of the parts listed below, always keep them out of the reach of small children.



- Included Parts
- Rubber feet (p. 3)

⚠ CAUTION

Handle the ground terminal carefully

If you remove the screw from the ground terminal, be sure to replace it; don't leave it lying around where it could accidentally be swallowed by small children. When refastening the screw, make that it is firmly fastened, so it won't come loose.



IMPORTANT NOTES

Power Supply

- Do not connect this unit to same electrical outlet that is being used by an electrical appliance that is controlled by an inverter or a motor (such as a refrigerator, washing machine, microwave oven, or air conditioner). Depending on the way in which the electrical appliance is used, power supply noise may cause this unit to malfunction or may produce audible noise. If it is not practical to use a separate electrical outlet, connect a power supply noise filter between this unit and the electrical outlet.
- The AC adaptor will begin to generate heat after long hours of consecutive use. This is normal, and is not a cause for concern.

Placement

- Using the unit near power amplifiers (or other equipment containing large power transformers) may induce hum. To alleviate the problem, change the orientation of this unit; or move it farther away from the source of interference.
- This unit may interfere with radio and television reception. Do not use this unit in the vicinity of such receivers.
- Noise may be produced if wireless communications devices, such as cell phones, are operated in the vicinity of this unit. Such noise could occur when receiving or initiating a call, or while conversing. Should you experience such problems, you should relocate such wireless devices so they are at a greater distance from this unit, or switch them off.
- When moved from one location to another where the temperature and/or humidity is very different, water droplets (condensation) may form inside the unit. Damage or malfunction may result if you attempt to use the unit in this condition. Therefore, before using the unit, you must allow it to stand for several hours, until the condensation has completely evaporated.
- Depending on the material and temperature of the surface on which you place the unit, its rubber feet may discolor or mar the surface.
- Do not place containers or anything else containing liquid on top of this unit. Also, whenever any liquid has been spilled on the surface of this unit, be sure to promptly wipe it away using a soft, dry cloth.

- When using the unit with it unmounted in a rack, attach the included rubber feet (4) if necessary. Placing the unit on a surface without attaching its rubber feet might cause the surface to be marred.
 - Peel off the double-sided tape from the rubber feet and affix the rubber feet at the locations shown in the figure.

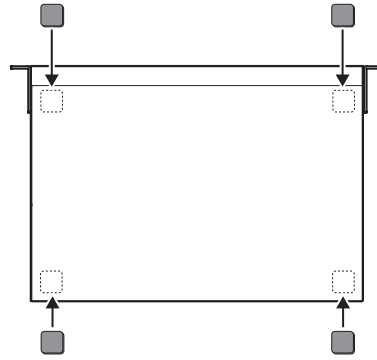

Maintenance

- Never use benzene, thinners, alcohol or solvents of any kind, to avoid the possibility of discoloration and/or deformation.

Repairs and Data

- Before sending the unit away for repairs, be sure to make a backup of the data stored within it; or you may prefer to write down the needed information. Although we will do our utmost to preserve the data stored in your unit when we carry out repairs, in some cases, such as when the memory section is physically damaged, restoration of the stored content may be impossible. Roland assumes no liability concerning the restoration of any stored content that has been lost.

Additional Precautions

- Any data stored within the unit can be lost as the result of equipment failure, incorrect operation, etc. To protect yourself against the irretrievable loss of data, try to make a habit of creating regular backups of the data you've stored in the unit.
- Roland assumes no liability concerning the restoration of any stored content that has been lost.
- Use a reasonable amount of care when using the unit's buttons, sliders, or other controls; and when using its jacks and connectors. Rough handling can lead to malfunctions.
- Never strike or apply strong pressure to the display.
- When disconnecting all cables, grasp the connector itself—never pull on the cable. This way you will avoid causing shorts, or damage to the cable's internal elements.
- To avoid disturbing others nearby, try to keep the unit's volume at reasonable levels.

- This unit allows you to switch images at high speed. For some people, viewing such images can cause headache, nausea, or other discomfort. Do not use this unit to create video that might cause these types of health problems. Roland Corporation will accept no responsibility for any such health problems that may occur in yourself or in viewers.
- Do not use connection cables that contain a built-in resistor.

Using External Memories

- Please observe the following precautions when handling external memory devices. Also, make sure to carefully observe all the precautions that were supplied with the external memory device.
 - Do not remove the device while reading/writing is in progress.
 - To prevent damage from static electricity, discharge all static electricity from your person before handling the device.

Intellectual Property Right

- It is forbidden by law to make an audio recording, video recording, copy or revision of a third party's copyrighted work (musical work, video work, broadcast, live performance, or other work), whether in whole or in part, and distribute, sell, lease, perform or broadcast it without the permission of the copyright owner.
- Do not use this product for purposes that could infringe on a copyright held by a third party. We assume no responsibility whatsoever with regard to any infringements of third-party copyrights arising through your use of this product.
- This product can be used to record or duplicate audio or visual material without being limited by certain technological copy-protection measures. This is due to the fact that this product is intended to be used for the purpose of producing original music or video material, and is therefore designed so that material that does not infringe copyrights belonging to others (for example, your own original works) can be recorded or duplicated freely.
- This product contains eParts integrated software platform of eSOL Co.,Ltd. eParts is a trademark of eSOL Co., Ltd. in Japan.
- Roland is an either registered trademark or trademark of Roland Corporation in the United States and/or other countries.
- Company names and product names appearing in this document are registered trademarks or trademarks of their respective owners.
- VISCA is a protocol developed by Sony for controlling a consumer's camcorder.
- "VISCA" is a trademark of Sony Corporation.

Panel Descriptions

Front Panel

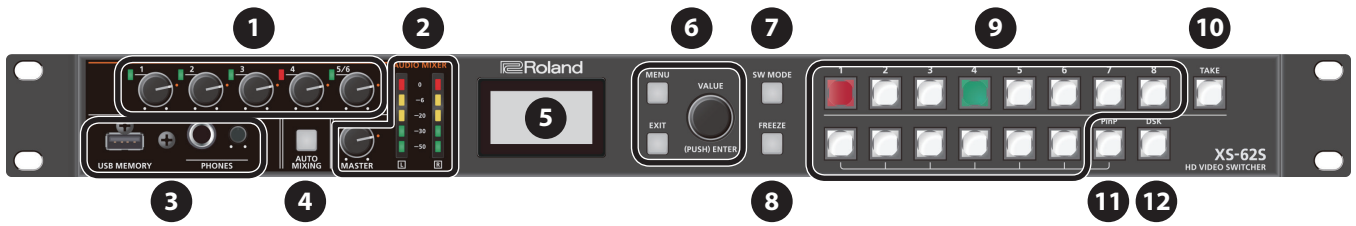

#	Name	Explanation	Page	
1	AUDIO MIXER [1]–[5/6] knobs	These adjust the volume level for AUDIO IN 1–5/6.	p. 25	
	SIG/PEAK indicators	This lights up when input via AUDIO IN 1–5/6 is detected, and when the volume level is too high.	p. 25	
2	[MASTER] knob	This adjusts the level of the PGM/1 bus.	p. 26	
	AUDIO MIXER level meters	This indicates the volume level of the PGM/1 bus.		
3	USB MEMORY port	Refer to the “USB MEMORY port” (p. 9), “PHONES jack” (p. 9), and “[PHONES] knob” (p. 9).		
	PHONES jack			
	[PHONES] knob			
4	[AUTO MIXING] button	This switches the Auto Mixing feature on and off. When the feature is turned on, the [AUTO MIXING] button lights up in green.	p. 29	
5	Built-in display	According to the setting of the [SW MODE] button, this indicates the current status.	—	
6	[MENU] button	This switches between displaying or hiding the menu. The menu is shown both on this unit’s display and on the multi-view monitor (p. 10) that’s connected to the HDMI OUT 3 connector. * To show the menu from the HDMI OUT 3 connector, set “OUTPUT ASSIGN” (p. 16) to “MULTI-VIEW.”	p. 11	
	[EXIT] button	This returns you to the menu one level higher.		
	[VALUE] button	Turning: This selects a menu item or changes a setting value. Pressing: This accepts the selected menu item or applies changes to a setting. It also executes operations.		
7	[SW MODE] button	This switches the functioning of the Cross Point [1]–[8] buttons.	—	
8	[FREEZE] button	This stops (freezes) input video. When on, this is lit red.	p. 19	
9	Cross-point [1]–[8] buttons	The function of these buttons changes depending on the color of the [SW MODE] button.	—	
		[SW MODE] button color	Explanation	
		Orange	The buttons select the video that is output to the PGM/1 or PVW/2 bus.	p. 17
		Green	The buttons select the video that is output to the AUX/3 bus.	
		Blue	The buttons recall preset memories.	p. 33
Pink	The buttons are used by the GPO and camera control functions.	p. 36		
10	[TAKE] button	This button outputs the video of the PVW/2 bus to the PGM/1 bus. * This is available only in PGM-PST mode (p. 17).	p. 17	
		The video from PinP or split is output to the PGM/1 bus.	p. 22 p. 23	
11	[PinP] button	This switches PinP or split video composition on and off. * In MATRIX mode (p. 18), this button selects the channel 7 video of the PVW/2 bus.	p. 22	
12	[DSK] button	This switches DSK composition on or off. * In MATRIX mode (p. 18), this button selects the channel 8 video of the PVW/2 bus.	p. 27	

Connecting Your Equipment (Rear Panel / Front Panel)

- * To prevent malfunction and equipment failure, always turn down the volume, and turn off all the units before making any connections.
- * Be sure to use cables and adaptor plugs with the proper connectors matching those of the other devices you are using.

RS-232 connector, CONTROL connector

- A remote-control device (such as a computer that supports RS-232) can be connected here to remotely control the XS-62S.
- You use "XS-62S RCS" dedicated software to operate the XS-62S remotely from a connected computer (p. 36).
- You can connect a LAN-compatible PTZ camera, and control the camera remotely.

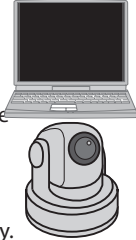

RS-422 connector, TALLY/GPIO connector

- You can connect a VISCA-compatible video camera to the RS-422 connector and operate the camera remotely from the XS-62S.
- Connect devices provided with a tally-light feature or with control-signal output functionality to this connector.

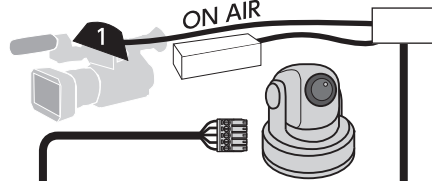

SDI IN 1-4 connectors

These connectors input video signals from video cameras, video recorders, and other video equipment.

- * Channels 1 through 4 are allocated to the respective inputs.

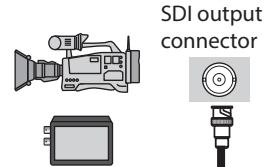

Grounding terminal

Connect this to an external earth or ground.

- * Connect this if necessary.

[POWER] switch

This turns the power on and off (p. 11).

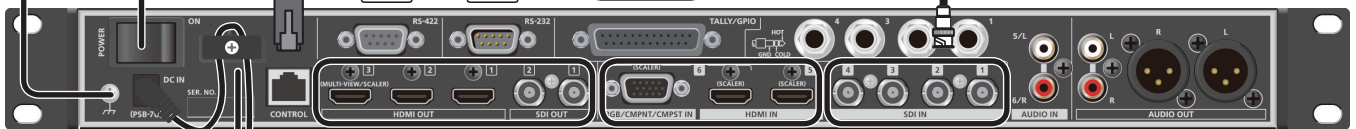

Cord hook

Use the cord hook to secure the AC adaptor cord as shown in the illustration.

- * To prevent the inadvertent disruption of power to your unit (should the plug be pulled out accidentally), and to avoid applying undue stress to the jack, anchor the power cord using the cord hook, as shown in the illustration.

SDI OUT 1, 2 connectors HDMI OUT 1-3 connectors

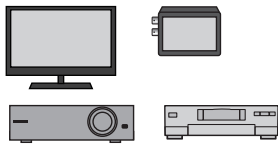

This outputs the results of video mixing (PGM/1-bus video), preview video (PVW/2-bus video), or AUX/3-bus video. Connect them to devices such as projectors, video recorders, or external displays.

- * The XS-62S has three internal output buses (PGM/1, PVW/2, and AUX/3), and you can select the bus to output for each individual connector (p. 16).
- * In addition to outputting a list of input/output videos or outputting the OSD menu, the HDMI OUT 3 connector can also output video at a variety of resolutions (p. 10).

HDMI IN 5, 6 connectors RGB/CMPNT/CMPST IN 6 connector

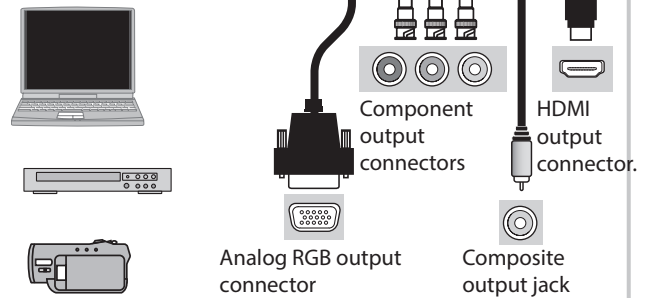

These connectors input video signals from a computer or video devices such as video cameras and DVD players.

- * Channels 5 and 6 are allocated to the respective inputs.
- * For channel 6, setting an assigned input connector is necessary (p. 13).

DC IN jack

Connect the included AC adaptor to this jack.

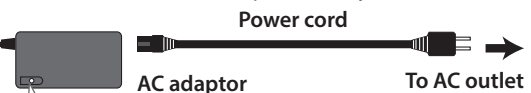

Place the AC adaptor so the side with the indicator (see illustration) faces upwards and the side with textual information faces downwards. The indicator will light when you plug the AC adaptor into an AC outlet.

AUDIO IN 1-4 jacks (TRS)

These jacks input audio signals from microphones, audio mixers, audio mixers, and other such audio equipment.



Audio output connectors

AUDIO IN 5/L, 6/R jacks

These jacks input audio signals from video decks, CD players, and other such audio equipment.



Audio output connectors

AUDIO OUT connectors/jacks (XLR and RCA)

Connect them to an audio recording deck, amplifier, speakers, or other such equipment. You can choose from PGM/1, PVW/2, or AUX/3 bus as the output.

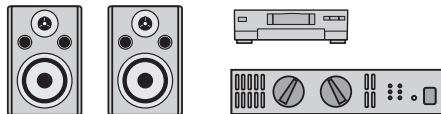

Audio input connectors

Rear panel

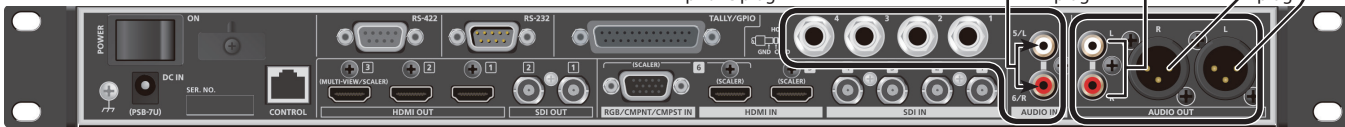

Front panel

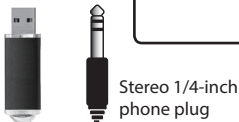

[PHONES] knob
This adjusts the volume level for headphones.

USB MEMORY port

Connect a USB flash drive to this port. You use it when importing still images (p. 20) or when saving or loading settings for the unit (p. 34).

- * When using a USB flash drive for the first time, you must format it using the XS-62S (p. 34).
- * Never turn off the power or remove the USB flash drive while the USB flash drive is being accessed.

PHONES jack

Connect headphones to this jack. You can choose from PGM/1, PVW/2, or AUX/3 bus as the output.



Pin assignment of AUDIO IN 1-4 jacks (TRS)

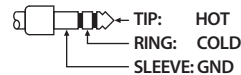

Pin assignment of AUDIO OUT connectors (XLR)



Multi-view Monitor Display

The output of the HDMI OUT 3 connector can display a list of input/output videos, an audio level meter, and a menu screen.

* Multi-view monitor display is available when the HDMI OUT 3 connector's "OUTPUT ASSIGN" (p. 16) is set to "MULTI-VIEW."

* When you press the [MENU] button, the menu appears in the screen (OSD menu). It shows the same content as the menu shown on the built-in display (p. 11). Label names, tally borders, and the audio level meter are hidden while the OSD menu is displayed.



#	Name	Explanation
1	PVW/2 (preview) section	This displays the video of the PVW/2 bus.
2	PGM/1 (program) section	This displays the video of the PGM/1 bus.
3	Channel section	<p>This displays video input via channels 1–6 and still images assigned to channels 7 and 8. The PGM/1 bus video and PVW/2 bus video are displayed with tally borders.</p> <p>Channel Information</p> <ol style="list-style-type: none"> When the Audio Follow feature is on (p. 30), the "A.F." symbol is displayed. When video or a still image is being sent to the AUX/3 bus (p. 18), the "AUX" symbol is displayed. This displays a level meter for SDI IN or HDMI IN audio. <p>The level meter indices are the same as for the level meters of each bus.</p>



This displays the level meter of each bus.

(dB)

- 0 — Red (Excessive)
- 6 — Yellow (Suitable)
- 20 — Green (Insufficient)
- 30
- 50



MEMO

- You can change the settings so that the label names, tally borders, audio level meter, OSD menu, and other such elements displayed on the multi-view monitor are always hidden.
 - Select the [MENU] button → "SYSTEM," then set the menu items shown below to "OFF."
 - MULTI-VIEW LABEL (label names)
 - MULTI-VIEW TALLY (tally borders and AUX symbol)
 - LEVEL METER (audio level meter and A.F symbol)
 - ON SCREEN MENU (OSD menu)
- You can exchange the PVW section and the PGM section between left and right. Use [MENU] button → "SYSTEM" → "MV LAYOUT" set to "PGM.PVW."
- You can change the labels of IN1 SDI through IN6 COMPOSITE that are shown in the channel section. Use [MENU] button → "SYSTEM" → "MV LABEL EDIT," then choose "IN1 SDI"–"IN6 COMPOSITE" and specify a label.

Basic Operations

Turning the Power On and Off

- * Before turning the unit on/off, always be sure to turn the volume down. Even with the volume turned down, you might hear some sound when switching the unit on/off. However, this is normal and does not indicate a malfunction.

Turning the power on

- * If still images are saved on the unit (p. 19), startup takes longer time according to image size and the number of still images saved.

1. Make sure all devices are turned off.
2. Turn on the power of the XS-62S.

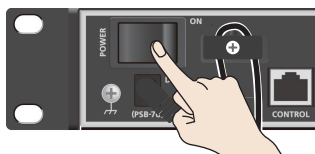

3. Turn on the power of the source devices.

Turn on the power of the source devices that are connected to the XS-62S's input connectors, such as video cameras.

4. Turn on the power of the output devices.

Turn on the power of the devices that are connected to the XS-62S's output connectors, such as projectors.

Turning the power off

1. Turn off the power in the order of output devices → source devices.
2. Turn off the power of the XS-62S.

About the Auto Off function

The power to the XS-62S turns off automatically when all of the following states persist for 240 minutes (Auto Off function).

- No operation performed on the XS-62S
- No audio or video input
- No equipment is connected to the HDMI OUT connectors

If you do not want the power to be turned off automatically, disengage the Auto Off function. Select the [MENU] button → "SYSTEM" → set "AUTO OFF" to "OFF".

NOTE

- Any settings that you are in the process of editing will be lost when the power is turned off. If you have any settings that you want to keep, you should save them beforehand.
- To restore power, turn the power on again.

Operating the Menu

This makes menus appear on the built-in display for making settings for video and audio or for the XS-62S itself.

- * The OSD menu is also shown in the output from the HDMI OUT 3 connector whose "OUTPUT ASSIGN" is set to "MULTI-VIEW" (p. 10).

1. Press the [MENU] button to display the menu.

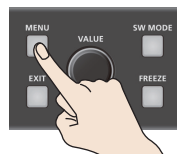

The [MENU] button is lit, and the menu categories are displayed.

2. Turn the [VALUE] knob to select a category, and press the [VALUE] knob to confirm.

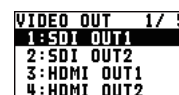
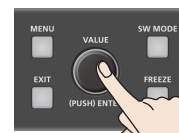

The menu for the selected category is displayed.

3. Turn the [VALUE] knob to select a menu item, then press the [VALUE] dial to confirm.

The cursor moves to the setting value.

- If the menu item is located at a deeper level, repeat step 3.
- Pressing the [EXIT] button moves you back one level higher.

4. Turn the [VALUE] knob to change the value of the setting.



- * By turning the [VALUE] knob while pressing it, you can change the value more greatly.

- To execute (confirm) the operation, press the [VALUE] knob.
- If you hold down the [VALUE] knob, the setting returns to the default value.

5. Press the [VALUE] knob to apply the setting.

The cursor returns to the menu item.

6. Press the [MENU] button to quit the menu.

MEMO

For details on the menu items, refer to the "Reference Manual" (PDF) which you can download from the Roland website.

<https://proav.roland.com/>

Video Input/Output Settings

Setting the Video Input/Output Format

Set parameters for the input/output format to match the connected equipment.

Setting the System Format

On the XS-62S, the input/output format is determined according to the system format. You set the input/output format to match the connected equipment.

1. Select the [MENU] button → “SYSTEM” → “SYSTEM FORMAT.”



2. Use the [VALUE] knob to specify the system format.

System format	Input format (*1)	Output format	
	SDI IN 1-4 connectors	SDI OUT 1 and 2 connectors HDMI OUT 1 and 2 connectors	HDMI OUT 3 connector
1080p	1080p, 1080i	1080p	(*2)
1080i	1080p, 1080i	1080i	
720p	720p	720p	

- (*1) You can specify separate individual input formats for the channel 5 and 6 input connectors (HDMI IN 5, HDMI IN 6, and RGB/CMPNT/CMPST IN 6), regardless of the system format. For details, refer to “Setting the Input Formats for Channels 5 and 6” (p. 13).
- (*2) If the HDMI OUT 3 connector’s “OUTPUT ASSIGN” (p. 16) is set to “MULTI-VIEW,” the output format is fixed at “1080p.” For output formats other than when MULTI-VIEW is selected, refer to “Output formats using the scaler” (p. 12).

3. Press the [VALUE] knob to apply the setting.
4. Press the [MENU] button to quit the menu.

Internal processing

The XS-62S’s internal processing is progressive. Interlaced input video is automatically converted to a progressive signal.

The picture might appear jagged at this time, or the picture in a PinP inset screen or on the multi-view monitor might waver.

This is due to progressive conversion, and is not a malfunction.

About frame rates

Frame rates that can be input are “59.94 Hz” and “50 Hz.”

Inputting video at a frame rate other than these might result in no output or dropped frames.

To change the frame rate, press the [MENU] button → “SYSTEM” → “FRAME RATE.”

Output formats using the scaler

If the HDMI OUT 3 connector’s “OUTPUT ASSIGN” (p. 16) is set to something other than MULTI-VIEW, you can use the scaler to output a variety of output resolutions.

Frame rate	
When set at “59.94 Hz”	When set at “50 Hz”
480/59.94p	576/50p
720/59.94p	720/50p
1080/59.94p	1080/50p
800 x 600, 60 Hz	800 x 600, 75 Hz
1024 x 768, 60 Hz	1024 x 768, 75 Hz
1280 x 800, 60 Hz	1280 x 800, 75 Hz
1280 x 1024, 60 Hz	1280 x 1024, 75 Hz
1366 x 768, 60 Hz	1366 x 768, 75 Hz
1400 x 1050, 60 Hz	1400 x 1050, 75 Hz
1600 x 1200, 60 Hz	1600 x 1200, 60 Hz
1920 x 1200, 60 Hz	1920 x 1200, 60 Hz

Checking the Video Format Being Input

If you press the [SW MODE] button several times to make it turn orange or green, the format of the currently selected input channel is shown on this unit’s display.

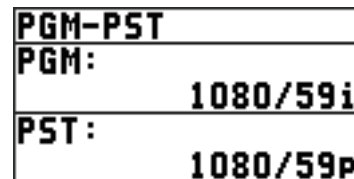

The INPUT STATUS of each input connector is also a way for you to check the format of the input signal.

[MENU] button → “VIDEO INPUT” → each input connector → “INPUT STATUS”

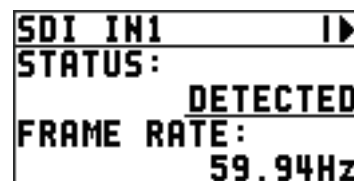

Setting the Input Formats for Channels 5 and 6

By factory default, the EDID assignment for channels 5 and 6 is "INTERNAL" (set so that EDID values of all inputtable formats are sent).

To specify an input format of your choice, change the setting of the EDID information being sent so that it matches the incoming video signal.

MEMO

EDID information is not sent during component or composite signal input.

1. Channel 5

Select the [MENU] button → "VIDEO INPUT" → "HDMI IN 5" → "EDID."

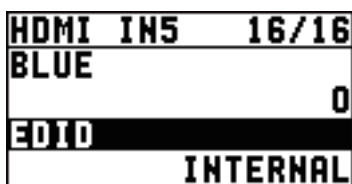

Channel 6

Select the [MENU] button → "VIDEO INPUT" → "HDMI/ANLG IN 6" → "EDID."

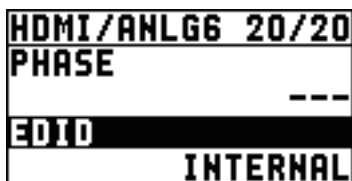

* The settings on the HDMI/ANLG IN 6 menu change in tandem with the assignment made using "INPUT ASSIGN" (p. 13). You can make separate individual settings for the respective menu items for the HDMI IN 6 connector and the RGB/CMPNT/CMPST IN 6 connector.

2. Use the [VALUE] knob to set the input format (the EDID information to send).

Value			
INTERNAL (EDID information for all inputtable formats is sent.)			
800 x 600	1024 x 768	1280 x 800	1280 x 1024
1366 x 768	1400 x 1050	1600 x 1200	1920 x 1200
720p (*3)	1080i (*3)	1080p (*3)	

(*3) For channel 6, this setting can be made only when "INPUT ASSIGN" (p. 13) is set to "HDMI."

3. Press the [VALUE] knob to apply the setting.

4. Press the [MENU] button to quit the menu.

Assigning a Video Source to Channel 6

You can assign a video source at the HDMI IN 6 connector or the RGB/CMPNT/CMPST IN 6 connector to channel 6.

You change the setting to match the connected source device.

* By factory default, the setting is for the HDMI IN 6 connector.

1. Select the [MENU] button → "VIDEO INPUT" → "HDMI/ANLG IN6" → "INPUT 6 ASSIGN."



2. Use the [VALUE] knob to specify the input connector to assign to channel 6.

Value	Explanation
HDMI	Video is input via the HDMI IN 6 connector.
RGB/COMPONENT	RGB video or component video is input via the RGB/CMPNT/CMPST IN 6 connector.
COMPOSITE	Composite video is input via the RGB/ CMPNT/CMPST IN 6 connector.

3. Press the [VALUE] knob to apply the setting.

4. Press the [MENU] button to quit the menu.

Adjusting Output Video

You can adjust the output video to match the equipment receiving the output from the XS-62S.

MEMO

You can output a test pattern, useful for adjusting the image quality of a display. You use the [MENU] button → “SYSTEM” → “TEST PATTERN” to specify the test pattern.

1. Select the [MENU] button → “VIDEO OUTPUT” → the output video.



A menu for the selected output video appears.

2. Select a menu item, then use the [VALUE] knob to adjust the output video.

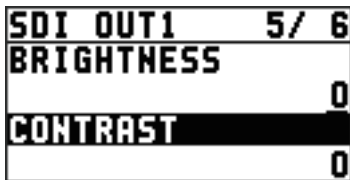

SDI OUT 1, 2: SDI OUT 1, 2 connectors

Menu item	Explanation
OUTPUT ASSIGN	This selects the bus (video) that is output from this connector.
3G-SDI MAPPING	This sets the mapping structure for 3G-SDI output.
H FLIP	Setting this to “ON” flips the output video horizontally.
BRIGHTNESS	This adjusts the brightness.
CONTRAST	This adjusts the contrast.
SATURATION	This adjusts the saturation.

HDMI OUT 1–3: HDMI OUT 1–3 connectors

Menu item	Explanation
OUTPUT ASSIGN (*1)	This selects the bus (video) that is output from this connector. The HDMI OUT 3 connector also lets you select multi view monitor display (p. 16).
RESOLUTION (*2)	This specifies the resolution of the output video (*3).
COLOR SPACE	This sets the color space (system for representing colors in video).
DVI-D/HDMI	This sets the output mode for HDMI output.
ZOOM (*2)	This adjusts the zoom ratio.
SCALING TYPE (*2)	This sets the scaling type.
H FLIP (*2)	Setting this to “ON” flips the output video horizontally.

Menu item	Explanation
MANUAL SIZE H (*2)	This adjusts the horizontal size.
MANUAL SIZE V (*2)	This adjusts the vertical size.
POSITION H (*2)	This adjusts the display position in the horizontal direction.
POSITION V (*2)	This adjusts the display position in the vertical direction.
BRIGHTNESS	This adjusts the brightness.
CONTRAST	This adjusts the contrast.
SATURATION	This adjusts the saturation.
RED	This adjusts the red level.
GREEN	This adjusts the green level.
BLUE	This adjusts the blue level.

- (*1) Refer to the “About the HDMI OUT 3 Connector” (p. 14).
- (*2) This is available when the HDMI OUT 3 connector’s “OUTPUT ASSIGN” (p. 16) is set to something other than “MULTI-VIEW.”
- (*3) If the HDMI OUT 3 connector’s “OUTPUT ASSIGN” (p. 16) is set to “MULTI-VIEW,” the output format is fixed at “1080p.” For output formats other than when MULTI-VIEW is selected, refer to “Output formats using the scaler” (p. 14).

3. Press the [VALUE] knob to apply the setting.

4. Press the [MENU] button to quit the menu.

About the HDMI OUT 3 Connector

The output of the HDMI OUT 3 connector can display a list of input/output videos, an audio level meter, and a menu screen (multi view monitor display).

It can also output video at a variety of resolutions using the scaler. For details on output settings for the HDMI OUT 3 connector, refer to “Selecting the Video of the Bus to Output” (p. 16).

Output formats using the scaler

If the HDMI OUT 3 connector’s “OUTPUT ASSIGN” (p. 16) is set to something other than MULTI-VIEW, you can use the scaler to output a variety of output resolutions.

Frame rate	
When set at “59.94 Hz”	When set at “50 Hz”
480/59.94p	576/50p
720/59.94p	720/50p
1080/59.94p	1080/50p
800 x 600, 60 Hz	800 x 600, 75 Hz
1024 x 768, 60 Hz	1024 x 768, 75 Hz
1280 x 800, 60 Hz	1280 x 800, 75 Hz
1280 x 1024, 60 Hz	1280 x 1024, 75 Hz
1366 x 768, 60 Hz	1366 x 768, 75 Hz
1400 x 1050, 60 Hz	1400 x 1050, 75 Hz
1600 x 1200, 60 Hz	1600 x 1200, 60 Hz
1920 x 1200, 60 Hz	1920 x 1200, 60 Hz

Adjusting the Input Video

This adjusts the image quality of the video input via the respective connectors. For HDMI IN and RGB/CMPNT/CMPST IN6 connectors, you can also adjust the scaling.

1. Select the [MENU] button → “VIDEO INPUT” → the input video.

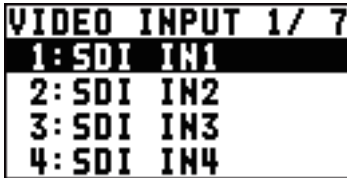

A menu for the selected input video appears.

2. Select a menu item, then use the [VALUE] knob to adjust the input video.

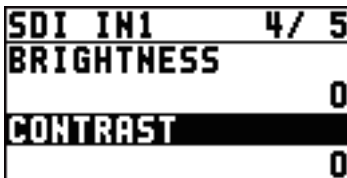

SDI IN 1–4: SDI IN 1–4 connectors

Menu item	Explanation
H FLIP	Setting this to “ON” flips the input video horizontally.
BRIGHTNESS	This adjusts the brightness.
CONTRAST	This adjusts the contrast.
SATURATION	This adjusts the saturation.

HDMI IN 5: HDMI IN 5 connectors

Menu item	Explanation
FLICKER FILTER	Setting this to “ON” reduces flicker.
ZOOM	This adjusts the zoom ratio.
SCALING TYPE	This sets the scaling type.
MANUAL SIZE H (*1)	This adjusts the horizontal size.
MANUAL SIZE V (*1)	This adjusts the vertical size.
POSITION H	This adjusts the display position in the horizontal direction.
POSITION V	This adjusts the display position in the vertical direction.
H FLIP	Setting this to “ON” flips the output video horizontally.
BRIGHTNESS	This adjusts the brightness.
CONTRAST	This adjusts the contrast.
SATURATION	This adjusts the saturation.
RED	This adjusts the red level.
GREEN	This adjusts the green level.
BLUE	This adjusts the blue level.
EDID	This sets the input format (EDID) for the HDMI IN 5 connector (p. 13).

(*1) This is available when “SCALING TYPE” is set to “MANUAL.”

HDMI/ANLG IN6:

HDMI IN 6 connector (*2), RGB/CMPNT/CMPST IN 6 connector (*2)

Menu item	Explanation
INPUT 6 ASSIGN	This selects the video signal that is input.
AUTO SAMPLING (*3)	This automatically adjusts the image quality.
FLICKER FILTER	Setting this to “ON” reduces flicker.
ZOOM	This adjusts the zoom ratio.
SCALING TYPE	This sets the scaling type.
MANUAL SIZE H (*4)	This adjusts the horizontal size.
MANUAL SIZE V (*4)	This adjusts the vertical size.
POSITION H	This adjusts the display position in the horizontal direction.
POSITION V	This adjusts the display position in the vertical direction.
H FLIP	Setting this to “ON” flips the output video horizontally.
BRIGHTNESS	This adjusts the brightness.
CONTRAST	This adjusts the contrast.
SATURATION	This adjusts the saturation.
RED	This adjusts the red level.
GREEN	This adjusts the green level.
BLUE	This adjusts the blue level.
FREQUENCY (*3)	This adjusts the input frequency.
PHASE (*3)	This adjusts the phase.
EDID	This sets the input format (EDID) of the HDMI IN 6 connector or RGB/CMPNT/CMPST IN 6 connector (p. 13).

(*2) The settings on the HDMI/ANLG IN 6 menu change in tandem with the assignment made using “INPUT ASSIGN” (p. 13). You can make separate individual settings for the respective menu items for the HDMI IN 6 signal, the RGB/COMPONENT signal, and the COMPOSITE signal.

(*3) This is effective when “INPUT ASSIGN” (p. 13) is set to “RGB/COMPONENT.”

(*4) This is available when “SCALING TYPE” is set to “MANUAL.”

3. Press the [VALUE] knob to apply the setting.
4. Press the [MENU] button to quit the menu.

Selecting the Video of the Bus to Output

The XS-62S has three internal output buses (PGM/1, PVW/2, AUX/3). You can select which the video of buses to output via the SDI OUT and HDMI OUT connectors.

MEMO

HDMI OUT 3 is also able to output MULTI-VIEW.

1. Select the [MENU] button → “VIDEO OUTPUT” → “SDI OUT 1,” “SDI OUT 2,” “HDMI OUT 1,” “HDMI OUT 2,” or “HDMI OUT 3” → “OUTPUT ASSIGN.”

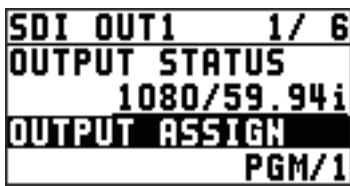

2. Use the [VALUE] knob to select the bus that you want to output: “PGM/1,” “PVW/2,” or “AUX/3.”

MEMO

“MULTI-VIEW” can be selected only for HDMI OUT 3.

3. Press the [VALUE] knob to apply the setting.
4. Press the [MENU] button to quit the menu.

MEMO

For details about video transitions on the PGM/1 bus and PVW/2 bus, refer to “Switching Using the PGM-PST Mode” (p. 17), “Switching Using the DISSOLVE Mode” (p. 17), “Switching Using the MATRIX Mode” (p. 18).

About Audio Outputs Assigned to Output Buses

Changing an output bus assignment makes the output audio also change in tandem, according to the assigned bus.

Output bus assignment	Output audio
PGM/1	This outputs the audio on the PGM/1 bus.
PVW/2	This outputs the audio on the PVW/2 bus.
AUX/3	This outputs the audio on the AUX/3 bus.

Inputting Copyright-protected (HDCP) Video

To input copyright-protected (HDCP) video from a Blu-ray Disc player or the like, follow the steps described below to change the “HDCP” setting.

* The XS-62S must be connected to an HDCP compatible display for HDCP protected video to be connected.

What’s HDCP?

HDCP is copyright-protection technology that prevents unlawful copying of content by encoding the path when sending digital signals from a video playback device to a display monitor or other display equipment.

1. Select the [MENU] button → “SYSTEM” → “HDCP.”

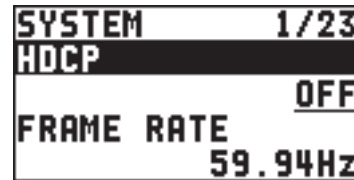

2. Use the [VALUE] knob to set this to “ON.”

Value	Explanation
ON	Copyright-protected (HDCP) video can be input. HDCP is also added to the video that is output.
OFF	Copyright-protected (HDCP) video cannot be input.

3. Press the [VALUE] knob to apply the setting.
4. Press the [MENU] button to quit the menu.

Output from connectors

When “HDCP” is set to “ON,” video is output only from the HDMI OUT and MULTI-VIEW connectors.

No video is output via the SDI OUT connectors.

Video Operations

Switching the Video

This selects video that is being input to the XS-62S, and outputs it to the PGM/1 bus.

About the Operation Mode for Video Transitions

There are three operation modes for switching the PGM/1 bus and PVW/2 bus: "PGM-PST mode," "DISSOLVE mode," and "MATRIX mode."

By factory default, the operation mode is set to the PGM-PST mode.

PGM-PST mode (p. 17)

You can select the preset video (the video to be output next) for the PVW/2 bus, and after checking that video, output it to the PGM/1 bus.

When you press the [TAKE] button, the PGM/1 bus video is exchanged with the PVW/2 bus video.

DISSOLVE mode (p. 17)

You can select the video that you want to output, and immediately output it to the PGM/1 bus.

MATRIX mode (p. 18)

You can individually select the video that is output to each bus (PGM/1, PVW/2, AUX/3 buses).

Setting the operation mode

1. Select the [MENU] button → "MODE."

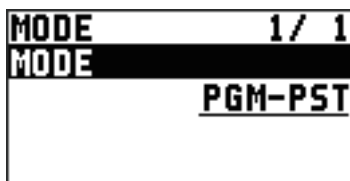

2. Use the [VALUE] knob to select either "PGM-PST," "DISSOLVE," or "MATRIX."
3. Press the [VALUE] knob to apply the setting.
4. Press the [MENU] button to quit the menu.

Switching Using the PGM-PST Mode

You can select the preset video (the video to be output next) for the PVW/2 bus, and after checking that video, output it to the PGM/1 bus.

1. Press the [SW MODE] button several times to make it light orange.
The buses selected by the cross-point buttons (upper row) will be the "PGM/1" and "PVW/2" buses.
2. Press a cross-point button (upper row) to select the preset video (the video to be output next).

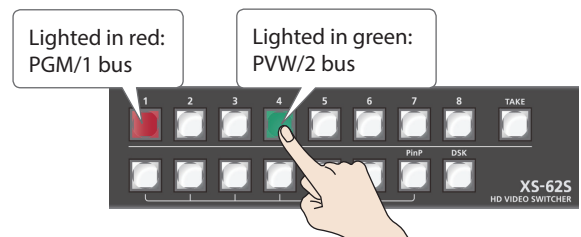

The channel you press is lit green. Alternatively, the preset video appears in the PVW/2 section of the multi-view monitor.

MEMO

You use channels 7 and 8 to output a still image or a monochrome picture (background color) (p. 19).

3. Press the [TAKE] button.

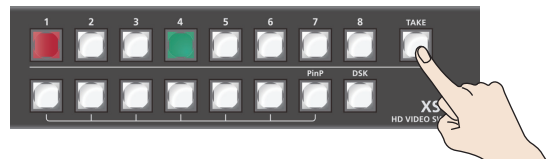

The video changes. At this time, the selected channel blinks red. When the video has switched completely, the selected channel's cross-point button is lit red.

Switching Using the DISSOLVE Mode

You can select the video that you want to output, and immediately output it to the PGM/1 bus.

1. Press the [SW MODE] button several times to make it light orange.
2. Press the cross-point button (upper row) that you want to output to the PGM/1 bus.

The channel you pressed blinks green, and the video switches. When the video has switched completely, the selected channel's cross-point button is lit red.

MEMO

- You use channels 7 and 8 to output a still image or a monochrome picture (background color) (p. 19).
- The PGM/1 bus and PVW/2 bus output the same video and audio.

Switching Using the MATRIX Mode

You can individually select the video that is output to each bus (PGM/1, PVW/2, AUX/3 buses).

1. To select the video that is output to the PGM/1 bus and PVW/2 bus, press the [SW MODE] button several times to make it light orange.

In this state, the bus selected by the upper row of cross-point buttons is "PGM/1," and the bus selected by the lower row is "PVW/2."

2. Press a cross-point button (upper row) to select the channel that is output to the PGM/1 bus, and press a cross-point button (lower row) to select the channel that is output to the PVW/2 bus.

The channels you pressed are lit yellow, and the video is output to the PGM/1 bus and PVW/2 bus.

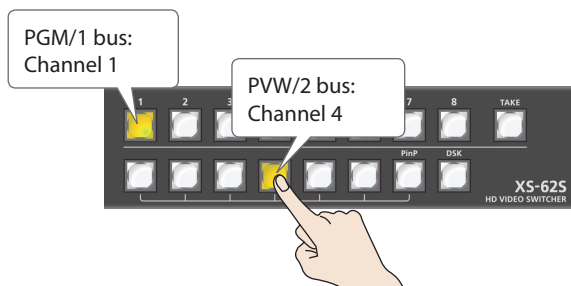

3. To select the video that is output to the AUX/3 bus, press the [SW MODE] button several times to make it light green.

The "AUX/3" bus will be the bus selected by the cross-point buttons (upper row).

4. Press the cross-point button (upper row) of the channel number that you want to send to the AUX/3 bus.

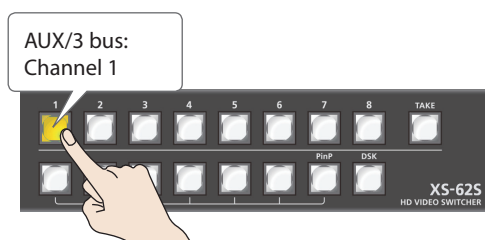

The channels you pressed are lit yellow, and the video is output to the AUX/3 bus.

MEMO

- To output the still image or monochrome video (background color), use the [PinP] button for channel 7 or the [DSK] button for channel 8 (p. 19).
- When the following conditions are satisfied, the channels are switched with a black fade effect.
 - When in MATRIX mode
 - When the TRANSITION TYPE is "MIX" or "WIPE"
 - When the TRANSITION TIME is other than "0.0sec."
- In MATRIX mode, the [TAKE] button does nothing.

Selecting the Channel for Output to the AUX/3 Bus

Here's how to select the channel that is output to the AUX/3 bus.

1. Press the [SW MODE] button several times to make it light green.

The "AUX/3" bus will be the bus selected by the cross-point buttons (upper row).

2. Press the cross-point button (upper row) of the channel number that you want to send to the AUX/3 bus.

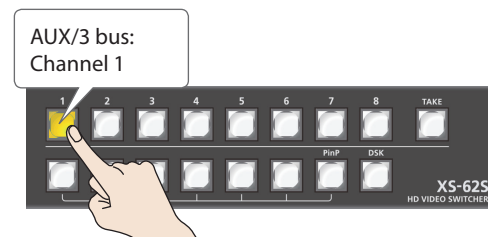

The channels you pressed are lit yellow, and the video is output to the AUX/3 bus.

MEMO

- In PGM-PST mode or DISSOLVE mode, the cross-point button that you press is lit red. In MATRIX mode, it is lit yellow.
- The video of the AUX/3 bus can be output from the SDI OUT connector and the HDMI OUT connector. If you want to output the AUX/3 bus, set the bus assignment of the respective connector to "AUX/3." For details, refer to "Selecting the Video of the Bus to Output" (p. 16).
- The channel that is output to the AUX/3 bus can be selected regardless of the video switching mode (PGM-PST, DISSOLVE, MATRIX).
- To adjust the volume of the audio of the AUX/3 bus, use [MENU] button → "AUDIO OUTPUT" → "AUX" → "AUX LEVEL."
- In the multi-view monitor, the "AUX" symbol is shown for the input channel that is being sent to the AUX/3 bus.

Switching Automatically (Auto Scan)

You can make the video on channels 1 through 6 switch automatically.

MEMO

- Any channels carrying no video input are skipped.
- The still image (channel 7, 8) is not shown in auto scan.

1. Select the [MENU] button → “SYSTEM” → “AUTO SCAN.”

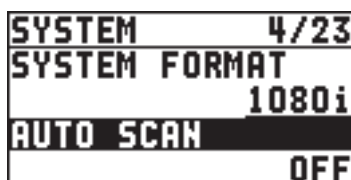

2. Use the [VALUE] knob to set this to “ON,” and press the [VALUE] knob.

Value	Explanation
ON	Video automatic switching is turned on. The video on channels 1 through 6 is switched automatically.
OFF	The video automatic switching feature is turned off.

3. Press the [MENU] button to quit the menu.

MEMO

You can set the interval for video display within the range of 1 to 120 seconds. Use the [SYSTEM] button → “SYSTEM” → “AUTO SCAN TIME” to make the setting.

Freezing Input Video (Freeze)

This temporarily pauses the incoming video.

When you are changing the connections between two computers during output, freezing the output before disconnecting the first computer and then ending the freeze after connecting the second computer makes it possible to change the connections without creating noise in the output.

1. Press the [FREEZE] button.

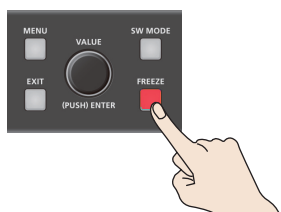

The [FREEZE] button is lit red. The input video freezes.

Using Imported Still Images

You can take a still image captured from input video or imported from a USB flash drive, assign it to channel 7 or 8, and output it in the same way as video. You can also use it as a source for DSK compositing (p. 27).

You can save up to two still images in the unit.

- * When still images are saved in the unit, startup takes longer time according to image size and the number of still images saved.

Capturing a Still Image from Input Video

This captures a still image from input video and saves it in the unit.

NOTE

- All video input stops during still-image capture.
- Depending on the format of the input video, completion of still-image capture might take some time.
- Created still images cannot be saved to a USB flash drive.
- Frozen video (p. 19) cannot be captured.

1. Select the [MENU] button → “CAPTURE IMAGE” → “CAPTURE SOURCE,” then use the [VALUE] knob to specify the input video to use for still-image capture.



2. Press the [VALUE] knob to apply the setting.

3. Select “TARGET STORAGE,” then use the [VALUE] knob to select “STILL IMAGE1” or “STILL IMAGE2” as the memory destination for saving the still image.

A “*” symbol is displayed for memory where a still image is already saved.

4. Press the [VALUE] knob to apply the setting.

5. Select “CAPTURE EXECUTE.”

A confirmation message appears.

If you want to cancel the operation, press the [EXIT] button.

6. Use the [VALUE] knob to select “YES,” then press the [VALUE] knob.

Capturing is carried out.

7. Press the [MENU] button to quit the menu.

MEMO

HDCP-applied Video on HDMI IN 5 and 6

When you have captured from copyright-protected (HDCP) video, the created still image is treated the same way as HDCP-applied video.

The still image is switched between displayed and hidden by turning HDCP on and off (p. 16).

Note, however, that when HDCP is switched from off to on, the still image is reloaded from where it's saved in memory, and so the still image might take some time to display.

Importing a Still Image from a USB Flash Drive

This imports into the unit a still image saved on a USB flash drive.

Supported still-image formats and resolutions

Still-image file formats that can be imported are as follows.

	Explanation
Format	Bitmap (.bmp), 24-bit color, uncompressed
Resolution	In conformity with system format (p. 12)
File name	No more than 8 single-byte alphanumeric characters Be sure to append the ".bmp" file extension.

Importing a still image

NOTE

- All video input stops while a still image is being imported from a USB flash drive.
- Large-size still-image files might take some time to import.
- When you're using a USB flash drive for the first time, be sure to format it on the XS-62S (p. 35).
- Depending on the USB flash drive, recognition of the flash drive might take some time.

1. Save the still image in the root directory of the USB flash drive.
2. Connect the USB flash drive containing the saved still image to the USB MEMORY port.
3. Select the [MENU] button → "USB MEMORY" → "LOAD STILL IMAGE."



4. Use the [VALUE] knob to select "STILL IMAGE1" or "STILL IMAGE2" as the memory where the still image is saved.

A "*" symbol is displayed for memory where a still image is already saved.

5. Press the [VALUE] knob.

The USB LOAD screen appears. The names of the files on the USB flash drive are displayed on this screen.

6. Select the still image file you want to import, then press the [VALUE] knob.

A confirmation message appears.

If you want to cancel the operation, press the [EXIT] button.

7. Use the [VALUE] knob to select "YES," then press the [VALUE] knob.

The still image is imported into the unit.

8. Press the [MENU] button to quit the menu.

Assigning Still Images to Channels 7 and 8

This takes a still image that has been captured or imported from a USB flash drive, and assigns it to channel 7 or 8.

1. Select the [MENU] button → "VIDEO INPUT" → "STL/BKG IN7/8" → "INPUT7 ASSIGN" or "INPUT8 ASSIGN."



2. Use the [VALUE] knob to select the memory where the still image is saved.

A "*" symbol is displayed for memory where a still image is already saved.

3. Press the [VALUE] knob to apply the setting.

4. Press the [MENU] button to quit the menu.

MEMO

Assigning a Monochrome Picture (Background Color)

You can also assign a monochrome picture (background color) to channel 7 or 8.

In step 2, set "INPUT7 ASSIGN" or "INPUT8 ASSIGN" to "BACKGROUND." Also, use "BACK COLOR" to specify the background color.

* The background-color setting is shared by channels 7 and 8.

Deleting a Still Image

This deletes a still image saved in the unit.

1. Select the [MENU] button → “SYSTEM” → “DELETE STILL.”



2. Use the [VALUE] knob to select “STILL IMAGE1” or “STILL IMAGE2” as the memory you want to delete.

A “*” symbol is displayed for memory where a still image is already saved.

3. Press the [VALUE] knob.

A confirmation message appears.

If you want to cancel the operation, press the [EXIT] button.

4. Use the [VALUE] knob to select “YES,” then press the [VALUE] knob.

The still image is deleted.

5. Press the [MENU] button to quit the menu.

Video Composition Operations

This composites video. The XS-62S has three built-in types of composition.

Compositing Using Picture-in-Picture (PinP)

This composites video in an inset screen over a background video. This section describes operations when in the PGM/PST mode (p. 17).

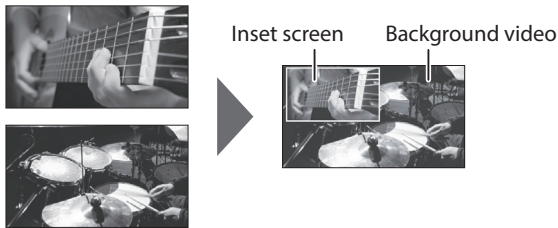

MEMO

Picture-In-Picture cannot be used in MATRIX mode (p. 18).

1. Press the [MENU] button → “COMPOSITION” → set “COMPOSITION TYPE” to “PinP.”

2. Press the [PinP] button to turn on video compositing (making the button light up).

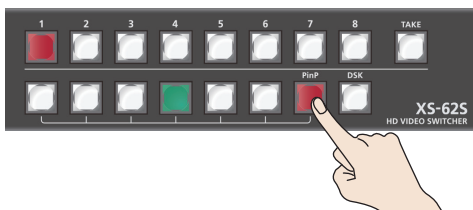

3. Press a cross-point (upper row) button for the PGM/1 bus to select the video you want to make the background video.

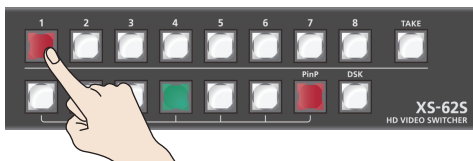

4. Press a cross-point (lower row) [1]–[6] button for the PVW/2 bus to select the video you want to make the inset screen.

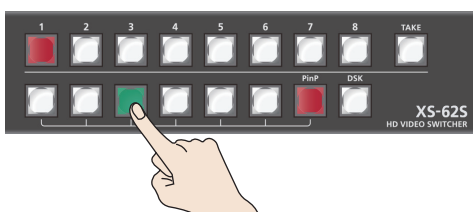

The cross-point button that you selected as PST is lit green. An inset screen is shown in the PVW/2 section of the multi-view screen, allowing you to check the position and size of the insert screen.

At this stage, it is not output to the PGM/1 bus.

MEMO

- It's not possible to check the Picture-In-Picture effect beforehand in the PVW/2 section of the multi view monitor in DISSOLVE mode (p. 17).
- You can't select the PVW/2 bus's [7] or [8].

5. Press the [TAKE] button.



The inset screen and background image are composited and output to the PGM/1 bus. The cross-point button for the PVW/2 bus light up in red.

When you press the [TAKE] button once again, you return to the video of only the PGM/1 bus.

MEMO













- To adjust the position and size of the inset screen, make settings in the menu. For details, refer to “Making detailed settings for the inset screen” (p. 22).
- The video transition-time setting is applied as the fade time when you use the [TAKE] button to display or hide the inset screen.

6. To turn off video composition, press the lighted [PinP] button.

Making detailed settings for the inset screen

You can make settings such as the size and position of the inset screen, and specify the width etc. of the border around the inset screen.

Select the [MENU] button → “COMPOSITION” → “PinP,” then make the settings for the menu items shown below.

Menu item	Explanation								
PinP SIZE	This sets the size. For the inset screen, you select a horizontal width of 1/2, 1/3, or 1/4 as the horizontal width of the background video.								
PinP POS H	This adjusts the display position in the horizontal direction.								
PinP POS V	This adjusts the display position in the vertical direction								
PinP BDR COLOR	This specifies the color of the border. Setting this to “SOFT EDGE” blurs the edge.								
PinP BDR WIDTH	This adjusts the border width.								
PinP SHAPE	This specifies the shape. <table border="1" style="width: 100%; text-align: center;"> <tr> <td>SQUARE</td> <td>CIRCLE</td> <td>HEART</td> <td>DIAMOND</td> </tr> <tr> <td></td> <td></td> <td></td> <td></td> </tr> </table>	SQUARE	CIRCLE	HEART	DIAMOND				
SQUARE	CIRCLE	HEART	DIAMOND						
									
PinP ASPECT	This specifies the aspect ratio.								
PinP CROPPING H	This adjusts the frame size in the horizontal direction.								
PinP CROPPING V	This adjusts the frame size in the vertical direction.								
PinP VIEW POS H	This adjusts the display position of the video within the inset screen in the horizontal direction.								
PinP VIEW POS V	This adjusts the display position of the video within the inset screen in the vertical direction.								

Compositing Using Split

This composites two video streams in a split screen. The video of the PGM/1 bus is composited above or on the left, and the video of the PVW/2 bus is composited below or on the right.

This section describes operations when in the PGM/PST mode (p. 17).

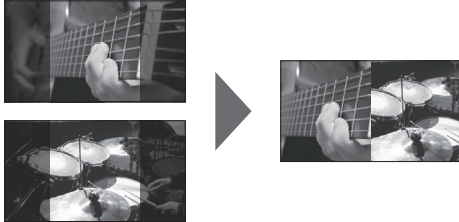

MEMO

Split cannot be used in MATRIX mode (p. 18).

1. Press the [MENU] button → “COMPOSITION” → set “COMPOSITION TYPE” to “SPLIT.”
2. Press the [PinP] button to turn on video compositing (making the button light up).

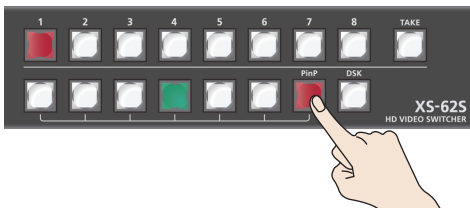

At this stage, there is no change in the video of the PGM/1 bus or the PVW/2 bus.

3. Press a cross-point button (upper row) for the PGM/1 bus to select the video you want to display above or on the left.

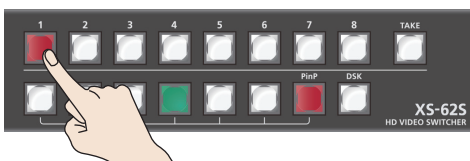

4. Press a cross-point button (lower row) for the PVW/2 bus to select the video you want to display below or on the right.

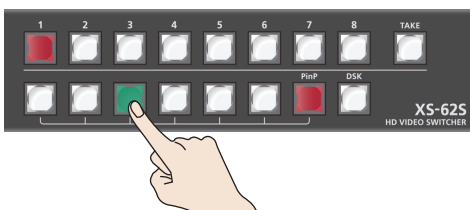

MEMO

It's not possible to check the split effect beforehand in the PVW/2 section of the multi view monitor.

5. Press the [TAKE] button.



The two videos are composited (split) and output to the PGM/1 bus. The [PinP] button and the cross-point button for the PVW/2 bus light up in red.

When you press the [TAKE] button once again, you return to the video of only the PGM/1 bus.

MEMO

You can specify the split composition pattern.

For details, refer to “Specifying a split composition pattern” (p. 23).

6. To turn off video composition, press the lighted [PinP] button.

Specifying a split composition pattern

You can specify the split composition pattern to match the video that you want to composite.

Select the [MENU] button → “COMPOSITION” → “SPLIT,” then make the settings for the menu items shown below.

Menu item	Explanation	
SPLIT PATTERN	This specifies the composition pattern.	
	V-CENTER	This vertically crops the center section of the video.
	H-CENTER	This horizontally crops the center section of the video.
	V-STRETCH	This stretches the video vertically.
H-STRETCH	This stretches the video horizontally. 	
SPLIT PGM-CTR (*1)	This adjusts the displayed position of the video at the left side or upper side.	
SPLIT PST-CTR (*1)	This adjusts the displayed position of the video at the right side or lower side.	
SPLIT CTR POS (*1)	This adjusts the boundary line, changing the size of the two video images.	

(*1) You can carry out adjustment when “V-CENTER” or “H-CENTER” is selected as the split composition pattern.

Compositing Using DSK

This takes video that was composited upstream using PinP etc., and performs further downstream compositing with text or images.

Using DSK (downstream keying), you can switch the background video while text or images remain displayed.

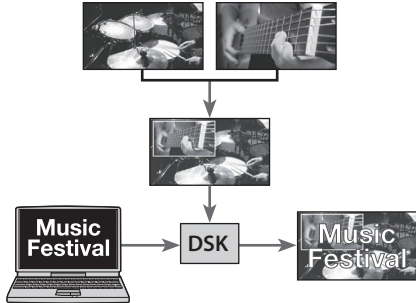

1. Input the logo or image.

By factory default, the settings are such that text and image input on channel 6 are used in DSK composition.

When you want to use text or image on another channel, use the [MENU] button → “DSK” → “DSK SOURCE CH” to change the channel.

When you want to composite a still image saved in the unit (p. 19), set this to “STL/BKG IN7” or “STL/BKG IN8.”

2. Output the background video.

The background video and the composited result are shown as a preview in the PVW/2 section of the multi view monitor.

At this stage, it is not output to the PGM/1 bus.

3. Press the [DSK] button to turn on DSK composition (lighted).

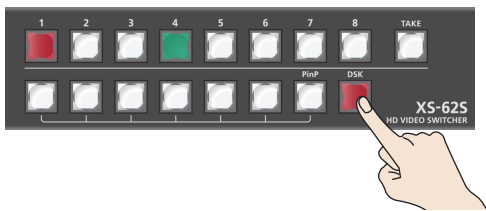

The [DSK] button lights up in red, and the text or image is composited and the results are output.

4. To turn off DSK compositing, press the [DSK] button a second time.

The [DSK] button goes dark and the text and images disappear from the output.

MEMO

- It's not possible to check the DSK compositing effect beforehand in the PVW/2 section of the multi view monitor in DISSOLVE mode (p. 17).
- The video transition-time setting is applied as the fade time for DSK-composited text and image.
- You can adjust the key type setting, the text to be DSK composited, and the mix level of the overall image. For details, refer to “Setting the key type and extraction color” (p. 24), “Setting the mix level and effect depth of the composited video” (p. 24).

Setting the key type and extraction color

To change the key type and extraction color to match the video you want to composite.

Select the [MENU] button → “DSK” → “KEY TYPE,” then make the settings for the menu items shown below.

Value	Explanation
LUMI-WHT	This uses a brightness threshold to make white transparent.
LUMI-BLK	This uses a brightness threshold to make black transparent.
CRM-GRN (*1)	This uses a color threshold to make green transparent.
CRM-BLU (*1)	This uses a color threshold to make blue transparent.

(*1) When the key type is chroma key (“CRM-GRN” or “CRM-BLU”), you can use the DSK menu to fine-tune the key color.

Menu item	Explanation
HUE WIDTH	This adjusts the hue width (range).
HUE FINE	This adjusts the center position for hue.
SATURATION WIDTH	This adjusts the saturation width (range).
SATURATION FINE	This adjusts the center position for saturation.

Setting the mix level and effect depth of the composited video

Here's how to adjust the mix level of the DSK-composited text and the overall video.

Select the [MENU] button → “DSK,” then make the settings for the menu items shown below.

Value	Explanation
LEVEL	This adjusts the degree of extraction (transparency) for the key.
GAIN	This adjusts the degree of edge blur (semi-transmissive region) for the key.
MIX LEVEL	You can adjust the overall density of the text and images being composited using DSK

MEMO

The video transition-time setting is applied as the fade time for DSK-composited text and image.

Audio Operations

Adjusting the Volume Level

This adjusts the head amp gain, sound position, and volume balance of audio input to the XS-62S.

Adjusting the Head Amp Gain

This adjusts the head amp gain so that the input audio is at a suitable level.

* You can adjust the head amp gain only for AUDIO IN 1 through 4.

1. For the input audio whose head amp gain you want to adjust, set the AUDIO MIXER knob to a position near the dot at the 2 o'clock position (0 dB).



2. Set the [MASTER] knob to a position near the 2 o'clock dot (0 dB).



3. Select the [MENU] button → "AUDIO INPUT" → "AUDIO IN 1" through "AUDIO IN 4" → "HEAD AMP GAIN."

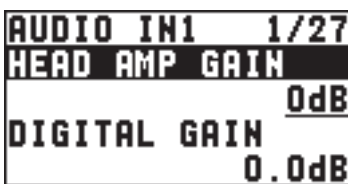

* When adjusting the head amp gain, check to make sure the value of "DIGITAL GAIN" is "0.0 dB."

4. Turn the [VALUE] knob counterclockwise to "0 dB."
5. Slowly turn the [VALUE] knob clockwise to adjust the head amp gain.

Use the [VALUE] knob to gradually raise the head amp gain as you play the actual incoming signal. Boost the head amp gain as high as possible without making the SIG/PEAK indicator light up in red.

SIG/PEAK indicator	Status
Red	When input reaches the peak value (0 dB)
Green	When input is detected (-50 dB or higher)

6. Press the [VALUE] knob to apply the setting.
7. Press the [MENU] button to quit the menu.

Adjusting the digital gain

On the XS-62S, separately from head amp gain, you can also adjust "digital gain." Whereas head amp gain adjusts analog audio, digital gain adjusts digital audio.

With SDI or HDMI digital audio input, when audio at a high level is input, effect processing can produce distortion.

Using digital gain lets you lower the input level so that effect processing is not affected.

Adjusting the Sound Position (Pan)

The left-right position of audio is called the sound position (pan).

This lets you broaden the sound by moving its sound position farther to the left and right at times such as when you're transmitting feed of a performance using two microphones.

* You can adjust the sound position only for AUDIO IN 1 through 4.

1. Select the [MENU] button → "AUDIO INPUT" → "AUDIO IN 1" through "AUDIO IN 4" → "PAN."

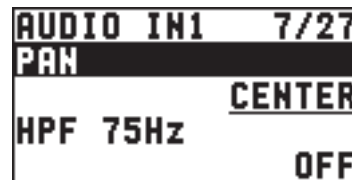

2. Use the [VALUE] knob to adjust the sound position.
3. Press the [VALUE] knob to apply the setting.
4. Press the [MENU] button to quit the menu.

Adjusting the Volume Balance

This adjusts the volume balance of input and the volume level for PGM/1 bus.

1. Set the [MASTER] knob to a position near the 2 o'clock dot (0 dB).
2. While monitoring the audio via speakers or headphones, adjust the volume balance for the respective inputs.

Raise the volume level of audio you want to make more prominent, for example, an emcee microphone, and lower the volume level for other audio.

When no audio is input, and for audio that is unused, lower the volume level to minimum.

AUDIO IN 1-5/6

Use the AUDIO MIXER knobs to adjust the volume level.



SDI IN 1-4, HDMI IN 5-6

Select the [MENU] button → "AUDIO INPUT" → "SDI IN 1-4" or "HDMI IN 5-6" → "PGM LEVEL," then use the [VALUE] knob to adjust the volume level.

3. Use the [MASTER] knob to adjust the volume level for PGM/1 bus.



A level at which indicators "-20" through "-6" light up is appropriate.

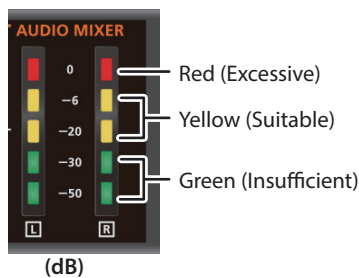

* If the volume level of speaker output is not suitable even after adjustment so that -20 to -6 light up, adjust the volume for the speakers or the amplifier. Using the [MASTER] knob to carry out further adjustment might result in distortion or degradation of sound quality.

MEMO

- You can output a test tone, which is useful for adjusting the volume level. Select the [MENU] button → "SYSTEM" → set "TEST TONE" to "-20dB@1kHz," "-10dB@1kHz," or "0dB@1kHz."
- In PGM-PST mode, the volume of the PVW/2 bus changes in tandem with the volume of the PGM/1 bus.
- In DISSOLVE mode, the PGM/1 bus and PVW/2 bus output the same audio.

Selecting the Audio of the Bus to Output

You can select the audio bus that is output from the AUDIO OUT jacks (XLR, RCA) and PHONES jack.

1. Select the [MENU] button → "AUDIO OUTPUT" → "OUTPUT ASSIGN" → "AUDIO OUT XLR," "AUDIO OUT RCA," or "PHONES OUT."

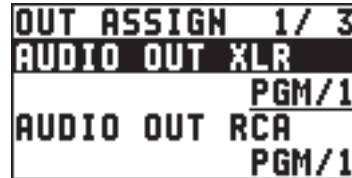

2. Use the [VALUE] knob to select the audio of the bus that you want to output.

Value	Explanation
PGM	This outputs the audio on the PGM/1 bus.
PVW	This outputs the audio on the PVW/2 bus.
AUX	This outputs the audio on the AUX/3 bus.

3. Press the [VALUE] knob to apply the setting.
4. Press the [MENU] button to quit the menu.

MEMO

- To adjust the volume level of audio on the AUX bus, select the [MENU] button → "AUDIO OUTPUT" → "AUX" → adjust "AUX LEVEL."
 - In DISSOLVE mode, the PGM/1 bus and PVW/2 bus output the same audio.
 - For the SDI OUT and HDMI OUT connectors, changing the assigned video bus makes the output audio also change in tandem with it.
- For details, refer to "Selecting the Video of the Bus to Output" (p. 16).

Applying Effects to Audio

You can apply effects and adjust the tone quality.

Applying Effects to Input Audio

This applies effects and adjusts the tone quality for AUDIO IN, SDI IN, and HDMI IN audio.

1. Select the [MENU] button → “AUDIO INPUT” → the input audio.



2. Select an effect menu item, then use the [VALUE] knob to adjust it.

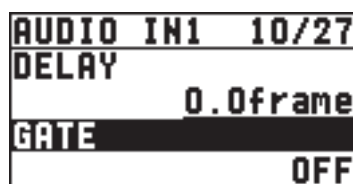

* For more information about effects, refer to the following section.

3. Press the [VALUE] knob to apply the setting.
4. Press the [MENU] button to quit the menu.

High-pass filter (HPF 75Hz)

This cuts off unneeded low-band audio. The cutoff frequency is 75 Hz.

Menu item	Explanation
HPF 75Hz	This sets the high-pass filter on or off.

Delay (DELAY)

This outputs audio with a delay.

Delaying audio output lets you align the output timing of video and audio.

Menu item	Explanation
DELAY	This adjusts the delay time for input audio.

Gate (GATE)

This mutes audio that is below a specified level.

Menu item	Explanation
GATE	This sets gate on or off.

Menu item	Explanation
THRESHOLD	This sets the level used as the threshold for removing audio. Audio below the level set here is removed.
RELEASE	This adjusts the length of time until the audio is fully attenuated after audio falls below the threshold.

Compressor (COMP)

This compresses audio that exceeds a specified level.

Menu item	Explanation
COMP	This sets the compressor on or off.
COMP THLD	This sets the level used as the threshold at which the compressor is applied. Compression is applied to audio that exceeds the threshold.
COMP RATIO	This species the degree of compression applied to the audio. The state in which no compression is applied is defined as “1.”
COMP ATTACK	This sets the time until compression starts when audio exceeding the threshold is input.
COMP RELEASE	This adjusts the length of time until compression ends after audio falls below the threshold.
COMP AUTO G	This switches the auto makeup gain feature on and off. When this is set to “ON,” the final output volume level after applying the compressor is automatically adjusted according to the “COMP THLD” and “COMP RATIO” settings. The total of the “COMP MAKE UP G” setting value described below and the value calculated by auto makeup gain becomes the final output volume level (up to +34 dB).
COMP MAKE UP G	This adjusts the final output volume level after applying the compressor.

Equalizer (EQ)

This adjusts the tone quality for each frequency band.

Menu item	Explanation
EQ Hi	This boosts or attenuates the high band.
EQ Hi FREQ	This adjusts the center frequency when changing the tone quality in the high band.
EQ Mid	This boosts or attenuates the middle band.
EQ Mid FREQ	This adjusts the center frequency when changing the tone quality in the middle band.
EQ Mid Q	This adjusts the width of the frequency band when boosting or attenuating the middle band.
EQ Lo	This boosts or attenuates the low band.
EQ Lo FREQ	This adjusts the center frequency when changing the tone quality in the low band.

Applying Effects to Output Audio

This applies effects and adjusts the tone quality for master out and AUX-bus audio.

* Only the limiter can be used on AUX-bus audio (p. 26).

1. Select the [MENU] button → “AUDIO OUTPUT” → “MASTER OUT,” “PVW,” or “AUX.”

AUDIO OUT	1 / 4
1: OUTPUT ASSIGN	
2: MASTER OUTPUT	
3: PVW	
4: AUX	

2. Select an effect menu item, then use the [VALUE] knob to adjust it.

MASTER OUT	10/18
EQ Lo FREQ	100Hz
MB COMP	OFF

* For more information about effects, refer to the following section.

3. Press the [VALUE] knob to apply the setting.
4. Press the [MENU] button to quit the menu.

Equalizer (EQ)

* PGM/1, PVW/2 bus only

This adjusts the tone quality for each frequency band.

Menu item	Explanation
EQ Hi	This boosts or attenuates the high band.
EQ Hi FREQ	This adjusts the center frequency when changing the tone quality in the high band.
EQ Mid	This boosts or attenuates the middle band.
EQ Mid FREQ	This adjusts the center frequency when changing the tone quality in the middle band.
EQ Mid Q	This adjusts the width of the frequency band when boosting or attenuating the middle band.
EQ Lo	This boosts or attenuates the low band.
EQ Lo FREQ	This adjusts the center frequency when changing the tone quality in the low band.

Multi-band compressor (MULTI BAND COMP)

* PGM/1, PVW/2 bus only

This applies separate compressors in individual frequency bands.

Menu item	Explanation
MB COMP	This switches the multi-band compressor on and off.
MB COMP H THLD MB COMP M THLD MB COMP L THLD	These set the individual levels that become the thresholds for the high, midrange, and low bands at which the compressor is applied. Compression is applied to audio that exceeds the threshold.
MB COMP H RATIO MB COMP M RATIO MB COMP L RATIO	These set the amount of compression applied in the high, midrange, and low bands. The state in which no compression is applied is defined as “1.”

Limiter (LIMITER)

This compresses audio input that is too high, thereby preventing distortion.

Menu item	Explanation
LIMITER	This sets the limiter on or off.
LIMITER THLD	This sets the level that becomes the threshold at which the limiter is applied. Compression is applied to audio that exceeds the threshold. The volume level of audio that is output is limited so as to stay below the threshold.

Controlling Fader Operation Automatically (Auto Mixing)

This automatically controls fader operations that normally are performed by an operator (Auto Mixing feature). It lets you rely on the XS-62S to perform complex fader operations, enabling use in circumstances where no dedicated operator is assigned.

This is especially useful for meetings, discussions, debates, and other situations where multiple microphones are used.

MEMO

Auto mixing can independently control the output to the PGM/1 bus and the output to the PVW/2 bus.

1. Follow the procedure in “Adjusting the Head Amp Gain” (p. 25) to adjust the input gain for channels 1 through 4.

2. Press the [AUTO MIXING] button to turn on the Auto Mixing feature (making the button light up).



3. To turn off the Auto Mixing feature, press the [AUTO MIXING] button a second time.

Adjusting the Auto Mixing Effect

If you want to adjust the auto mixing volume control to your preferred balance, you can make fine adjustments for each input.

1. Select the [MENU] button → “AUDIO AUTO MIXING.”



2. Select the audio to use with Auto Mixing, then use the [VALUE] knob to set it to “ON.”



Set audio where Auto Mixing is not needed, such as background music, to “OFF.”

3. Press the [VALUE] knob to apply the setting.

4. Set “WT” (weight), then use the [VALUE] knob to set the priority level for volume-level distribution (from 0 to 100%).

If there is audio that you want to make more prominent, such as when you want to raise the volume level of an emcee microphone, raise the weight level of that audio to emphasize it, and lower the weight level for other audio.

MEMO

- On audio to which Auto Mixing is applied, setting the weight level to “0%” results in no audio output.
- When air-conditioner noise or the like is a concern, set the weight level to a low value.

5. Press the [VALUE] knob to apply the setting.

Repeat steps 4 through 7 as needed.

6. Press the [MENU] button to quit the menu.

Silencing Specific Audio (Mute)

You can temporarily silence specific audio input or the audio output to a bus (Mute function).

Muting input audio

1. Select the [MENU] button → “AUDIO INPUT” → the input audio.



2. Select “PGM MUTE” or “PVW MUTE,” then use the [VALUE] knob to set it to “ON.”



To cancel muting, set this to “OFF.”

3. Press the [VALUE] knob to apply the setting.
4. Press the [MENU] button to quit the menu.

Muting the audio output to each bus

1. Select the [MENU] button → “AUDIO OUTPUT” → “MASTER OUT,” “PVW,” or “AUX.”



2. Select “OUTPUT MUTE,” “PVW MUTE,” or “AUX MUTE,” then use the [VALUE] knob to set it to “ON.”

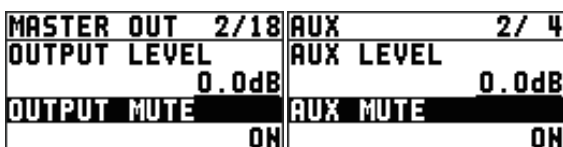

To cancel muting, set this to “OFF.”

3. Press the [VALUE] knob to apply the setting.
4. Press the [MENU] button to quit the menu.

Interlinking Audio Output to Video Switching (Audio Follow)

You can associate audio with a video switch so that when the video is switched, the specified audio alone is output automatically, and other audio is automatically muted.

NOTE

When the Audio Follow feature is turned on, switching between audio output and muting is carried out automatically.

The position of the knobs that adjust the volume does not change.

1. Follow the procedure in “Adjusting the Volume Level” (p. 25) to adjust to the volume level you want to output.

2. Select the [MENU] button → “AUDIO FOLLOW.”

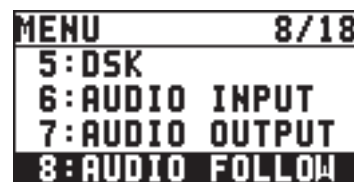

3. Select the video channel you want to use with Audio Follow, then use the [VALUE] knob to set it to “ON.”

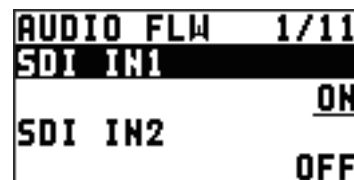

Value	Explanation
ON	This sets the Audio Follow feature on. Muting is performed automatically when video on another channel is output.
OFF	This sets the Audio Follow feature off.

4. Press the [VALUE] knob to apply the setting.

5. Press the [MENU] button to quit the menu.

6. Switch the video.

On video channels where Audio Follow is on, audio is automatically muted when video on other channels is output.

MEMO

You can check the Audio Follow settings by examining the channel section of the multi-view monitor. Video channels for which Audio Follow is turned on are displayed together with an “A.F.” symbol.



Applying audio follow to AUDIO IN 1–5/6

1. Select the [MENU] button → “AUDIO FOLLOW.”
2. From among “AUDIO IN 1” through “AUDIO IN 5/6,” select the input audio you want to use with Audio Follow.



3. Use the [VALUE] knob to specify the video channel to use with Audio Follow.

Value	Explanation
INPUT1–8	This sets the video channel to interlink with input audio using Audio Follow. Audio from AUDIO IN 1–5/6 is muted out for video channels other than what you specified.
OFF	This assigns no video channel to Audio Follow.

4. Press the [VALUE] knob to apply the setting.
5. Press the [MENU] button to quit the menu.

Separating Discrete Analog Input Audio Streams and Adding Them to SDI Video

The SDI OUT connectors on the XS-62S accommodate eight channels of embedded audio. The assigned bus (stereo audio) and the analog input audio (AUDIO IN 1–5/6) can be added to the SDI connector.

* The HDMI OUT connectors accommodate two channels of embedded audio. The assigned bus (stereo audio) can be added to the HDMI connector.

The audio shown below is assigned to the respective channels of SDI embedded audio.

SDI embedded-audio channel number	Assigned audio
Channel 1	The L-channel of the bus
Channel 2	The R-channel of the bus
Channel 3	AUDIO IN 1
Channel 4	AUDIO IN 2
Channel 5	AUDIO IN 3
Channel 6	AUDIO IN 4
Channel 7	AUDIO IN 5/L
Channel 8	AUDIO IN 6/R

Using this feature lets you separate up to six discrete channels of analog input audio and add it to SDI video.

As a Backup for Visual or Sound Recording...

Digital audio is extracted from the SDI embedded audio one channel at a time, so after visual recording or sound recording, you can edit the audio channel by channel.

For Multilingual Support...

Taking multilingual narration or other such audio, making it embedded audio and adding it to SDI video lets you later extract and use the digital audio for the required language.

1. Select the [MENU] button → “AUDIO EMB.”



2. From among “AUDIO IN 1” through “AUDIO IN 5/6,” select the input audio you want to send to the SDI embedded-audio channel.



3. Use the [VALUE] knob to set the audio type to “DRY” or “WET.”

Value	Explanation
OFF	No audio is sent.
DRY	This sends the source audio with no effects applied.
WET	This sends the effect-applied audio.

4. Press the [VALUE] knob to apply the setting.

Repeat steps 2 through 4 as needed.

5. Select “SDI OUT1 AUDIO” or “SDI OUT2 AUDIO,” then use the [VALUE] knob to set it to “CH1–8.”

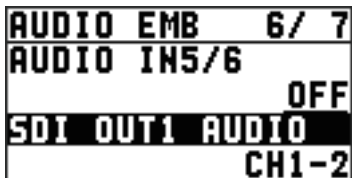

Audio containing channels 3 to 8 of embedded audio is output from the SDI OUT connector set to “CH1–8.”

6. Press the [VALUE] knob to apply the setting.

7. Press the [MENU] button to quit the menu.

Other Features

Saving/Recalling Settings (Preset Memory)

You can take the current settings, including video and audio settings and the state of the operation panel, and save them as a single set in memory, for later recall and use when needed. The XS-62S is provided with eight preset memories.

About the last memory function

The XS-62S has a built-in Last Memory feature. Last Memory is a feature that saves the state of the unit that is in effect immediately before power-down, and automatically restores the state at the next startup.

The Last Memory feature is enabled by default. When you want to call up a specified preset memory at startup, use the [MENU] button → “PRESET MEMORY” → “START UP” to specify the memory number.

Saving to a preset memory

NOTE

When you have selected the [MENU] button → “PRESET MEMORY” → “MEMORY PROTECT” and set this to “ON,” settings cannot be saved to a preset memory.

1. Press the [MENU] button → “PRESET MEMORY” → “SAVE” → choose the save-destination preset number (MEMORY1–MEMORY8), and then press the [VALUE] knob.

A confirmation message appears.

If you want to cancel the operation, press the [EXIT] button.

2. Use the [VALUE] knob to select “YES,” then press the [VALUE] knob.

The current settings are saved as a preset.

3. Press the [MENU] button to quit the menu.

MEMO

- The state of the [PHONES] knob is not saved to any preset memory.
- The following settings are saved as common settings for the entire XS-62S (they are not saved in a preset memory).

Category	Settings saved in the unit
REMOTE	All menu items
LAN	
SYSTEM	All setting items except “TEST PATTERN” and “TEST TONE” “TEST PATTERN” and “TEST TONE” are always set to “OFF” at startup.

Recalling settings

This calls up a saved preset.

When recalling a preset, by pre-specifying the setting values to call up, you can recall just some settings without having to call up all stored settings.

NOTE

If changes are made in the video input connectors or the output format in the preset after recalling, output video might become corrupted.

1. Press the [SW MODE] button to make it light up in blue.



The Cross-point buttons (upper row) function as memory selection buttons.

The cross-point selection buttons for numbers where presets are saved light up in blue.

2. Press the cross-point select button of the preset number whose settings you want to recall.

The settings are recalled. The cross-point select button that was recalled is lit light blue.

MEMO

- You can also recall a specified preset at startup. Use the [MENU] button → “PRESET MEMORY” → “START UP” to specify the preset number you want to recall.
- You can use the [MENU] button → “PRESET MEMORY” → “LOAD” to load a preset memory.

Deleting a preset memory

1. Select the [MENU] button → “PRESET MEMORY” → “DELETE.”



2. Use the [VALUE] knob to select the memory number (1 through 8) that you want to delete, then press the [VALUE] knob.

A confirmation message appears.

If you want to cancel the operation, press the [EXIT] button.

3. Use the [VALUE] knob to select “YES,” then press the [VALUE] knob.

The preset memory is deleted.

4. Press the [MENU] button to quit the menu.

Saving the Unit's Settings on a USB Flash Drive

You can save the settings of this unit collectively as a single file on a USB flash drive connected to the USB MEMORY port.

You can access the saved file (*.X62) on the USB flash drive and load it into the unit for use when needed.

- * When you're using a USB flash drive for the first time, be sure to format it on the XS-62S (p. 35).
- * Depending on the USB flash drive, recognition of the flash drive might take some time.

Saving a new settings file

1. Select the [MENU] button → "USB MEMORY" → "SAVE AS PRESET."



2. With the cursor positioned at "ENTER," press the [VALUE] knob.

The USB SAVE AS screen is displayed.

3. Enter the file name.

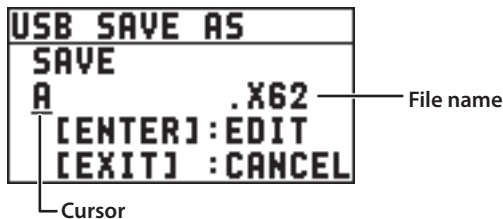

1. Use the [VALUE] knob to move the cursor.
 - Moving the cursor to a location where no character is present increases the number of characters.
2. Press the [VALUE] knob to highlight the character at the cursor location.
3. Use the [VALUE] knob to change the character, then press the [VALUE] knob to accept the change.
 - Pressing the [EXIT] button deletes the character at the cursor location.
 - You can enter a text string of up to 9 characters in length.
 - The extension of the file name is ".X62."

4. When you finish entering the name, use the [VALUE] knob to select "SAVE," then press the [VALUE] knob.

A confirmation message appears.

If you want to cancel the operation, press the [EXIT] button.

5. Use the [VALUE] knob to select "YES," then press the [VALUE] knob.

The file (*.X62) is newly saved on the USB flash drive.

6. Press the [MENU] button to quit the menu.

MEMO

Still images (p. 19) are not saved in the file (*.X62).

Overwrite-saving a settings file

1. Select the [MENU] button → "USB MEMORY" → "SAVE PRESET."

2. With the cursor positioned at "ENTER," press the [VALUE] knob.

The USB SAVE screen is displayed.

3. Select the file to overwrite, then press the [VALUE] knob.

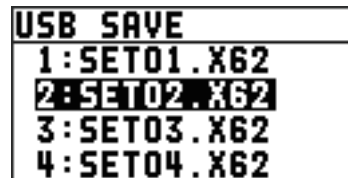

A confirmation message appears.

If you want to cancel the operation, press the [EXIT] button.

4. Use the [VALUE] knob to select "YES," then press the [VALUE] knob.

The file is saved by overwriting.

5. Press the [MENU] button to quit the menu.

Recalling

This recalls the unit's settings that were saved on a USB flash drive. When you recall these settings, the settings of the unit are overwritten.

1. Select the [MENU] button → "USB MEMORY" → "LOAD PRESET."

2. With the cursor positioned at "ENTER," press the [VALUE] knob.

The USB LOAD screen is displayed.

3. Select the file (*.X62) you want to recall, then press the [VALUE] knob.

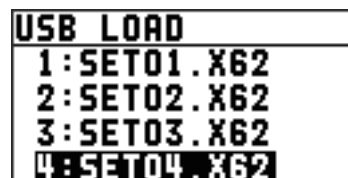

A confirmation message appears.

If you want to cancel the operation, press the [EXIT] button.

4. Use the [VALUE] knob to select "YES," then press the [VALUE] knob.

The settings are recalled, and the settings of the unit are overwritten.

5. Press the [MENU] button to quit the menu.

Formatting USB Flash Drives

When using a USB flash drive for the first time, be sure to format it on the XS-62S.

NOTE

- The XS-62S does not recognize unformatted USB flash drives.
- Use a commercially available USB flash drive or a USB flash drive sold by Roland. However, we cannot guarantee that all commercially available USB flash drives will work with this unit.
- Performing formatting causes all data already saved on the USB flash drive to be deleted. If the flash drive contains necessary data, back it up onto a computer or elsewhere before formatting the drive.

Making the connection

1. Connect the USB flash drive to the USB MEMORY port.



* Be careful to orient the USB flash drive correctly front and back and in the correct direction for insertion, and insert it firmly, as far as it will go. Never insert using undue force.

Performing formatting

1. Select the [MENU] button → “USB MEMORY” → “FORMAT.”



A confirmation message appears.

If you want to cancel the operation, press the [EXIT] button.

2. Use the [VALUE] knob to select “YES,” then press the [VALUE] knob.

Formatting of the USB flash drive is carried out.

3. Press the [MENU] button to quit the menu.

Returning Settings to the Factory-default State (Factory Reset)

You can return the values of settings on the XS-62S to their factory defaults.

If operation that differs from what is described in the owner's manual occurs even when the steps described are followed correctly, try performing a factory reset.

NOTE

Executing a factory reset causes all values that have been set, settings saved in preset memories (p. 33), and still images saved in the unit to be lost.

1. Select the [MENU] button → “SYSTEM” → “FACTORY RESET.”

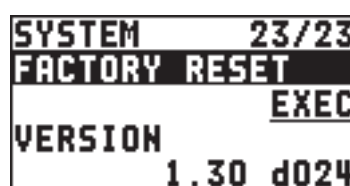

A confirmation message appears.

If you want to cancel the operation, press the [EXIT] button.

2. Use the [VALUE] knob to select “YES,” then press the [VALUE] knob.

A factory reset is executed.

3. Press the [MENU] button to quit the menu.

Preventing Unintended Operation (Panel Lock)

This locks operation of buttons and knobs to prevent unintended operation of the XS-62S.

1. Select the [MENU] button → “SYSTEM” → “PANEL LOCK.”



2. With the cursor positioned at “ENTER,” press the [VALUE] knob.

The PANEL LOCK menu appears.

3. Select a target for panel lock, then use the [VALUE] knob to specify whether panel lock is enabled (ON) or disabled (OFF).

You can select the following menu items as targets for panel lock.

Menu item	Target of panel lock
MENU+EXIT	[MENU] and [EXIT] buttons
VALUE	[VALUE] knob
CROSS POINT	Cross-point [1]–[8] buttons
SW MODE	[SW MODE] button
FREEZE	[FREEZE] button
PinP	[PinP] button
DSK	[DSK] button
TAKE	[TAKE] button
AUTO MIXING SW	[AUTO MIXING] button
CH VOLUME	AUDIO MIXER [1]–[5/6] knobs
MASTER VOLUME	[MASTER] knob

4. Press the [VALUE] knob to apply the setting.

Repeat steps 3 and 4 as needed.

5. Press the [MENU] button to quit the menu.

6. Press and hold the [EXIT] button and the [MENU] button at the same time (for 3 seconds or longer).

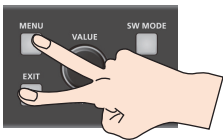

The message “PANEL LOCKED” is displayed, and panel lock is turned on. The button and controls that you set to enabled (ON) in step 3 are locked.

7. To turn off panel lock, again press and hold the [EXIT] button and the [MENU] button at the same time (for 3 seconds or longer).

The message “LOCK RELEASED” is displayed, and panel lock is turned off.

Operating the XS-62S or an External Device by Remote Control

You can remotely control the XS-62S from a computer, or remotely control an externally connected camera.

Using the dedicated XS-62S RCS program

You can connect the XS-62S to a computer via a CONTROL (LAN) connector, and use dedicated program XS-62S RCS to operate the unit by remote control.

For more information about operation methods, refer to the owner’s manual included with XS-62S RCS.

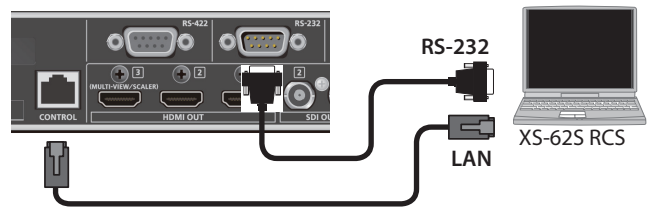

“XS-62S RCS” can be downloaded from the Roland website listed at the bottom of the page.

Using RS-232 or the CONTROL (LAN) connector

You can operate the XS-62S remotely from an external device.

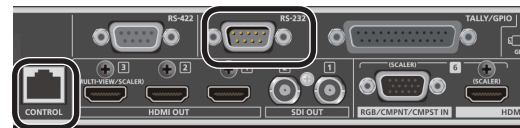

Using RS-422 connector

You can connect a VISCA-compatible video camera to the RS-422 connector and operate the camera remotely from the XS-62S.

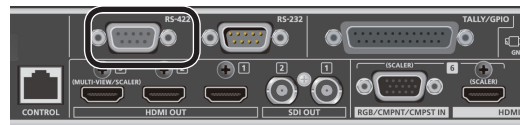

Roland website

XS-62S RCS can be downloaded from the Roland website.

For details on the specifications of the RS-232 connector and RS-422 connector, and for details on remote control, refer to the “Reference Manual” (PDF) which you can download from the Roland website.

<https://proav.roland.com/>



Outputting a Tally Signal

You can output a tally signal from the TALLY/GPIO connector.

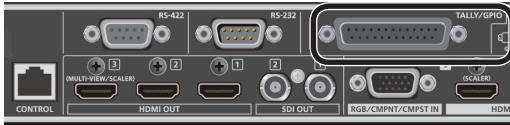

A tally signal is output from the connector pin corresponding to the video channel being output, also including video composition and transition effects.

* The tally signal output affects the video of the PGM/1 and PVW/2 buses.

Roland website

For the specifications of the TALLY/GPIO connector, refer to the Reference Manual (PDF), available for download at the Roland website.

<https://proav.roland.com/>



Appendices

Troubleshooting

If you suspect a malfunction, please check the following points. If this does not resolve the problem, contact a nearby Roland Service Center.

Problem	Items to check	Action	Page
Video-related problems			
No picture is input.	Is the unit detecting the input signal?	If you press the [SW MODE] button several times to make it turn orange or green, the format of the currently selected input channel is shown on this unit's display. You can also check the format of the input signal in each input connector's INPUT STATUS ([MENU] button → "VIDEO INPUT" → each input connector → "INPUT STATUS"). If video of a format that differs from the settings of the XS-62S is input, specify the system format as appropriate for the device that is connected.	p. 12
	Has the video source been correctly assigned to channel 6?	Specify the video source to assign to channel 6.	p. 13
	Is copyright-protected (HDCP) video being input?	When inputting copyright-protected (HDCP) video signals, go to the SETUP menu and set "HDCP" to "ON."	p. 16
Video from the computer is not displayed.	Is the format of the video output from the computer compatible with the XS-62S's input formats?	The supported input formats on channels 1 through 4 are 1080p, 1080i, and 720p. Only channels 5 and 6 supports VESA-standard resolutions.	p. 13
Video from the computer is corrupted.	When a rapidly moving video is input from a computer, out-of-sync motion, flicker, or other picture corruption may occur.	This is called "tearing," and does not indicate an equipment malfunction.	—
No picture is output.	Is "HDCP" set to "ON"?	When "HDCP" is set to "ON," video is output only from the HDMI OUT connectors. No video is output via the SDI OUT connectors.	p. 16
	Is the display connected correctly?	When outputting copyright-protected (HDCP) video, connect an HDCP-compatible display.	p. 16
"Snowy"-noise video is output.	It is possible that the HDMI signal is not being sent and received correctly.	Reconnect the HDMI cable.	—
The colors on the monitor screen connected via HDMI are incorrect.	Do the color-space settings for any monitors connected to the HDMI OUT connectors match the color-space setting on the XS-62S?	Use VIDEO OUTPUT menu → "HDMI OUT 1," "HDMI OUT 2," or "HDMI OUT 3" → "COLOR SPACE" to change the setting.	p. 14
		Depending on the device, the color space might be interlinked with the selection of DVI or HDMI or the selected format. In such cases, changing the color space on the output device might bring about improvement for the problem.	—
HDMI output shown on a display has its periphery cut off.	Are the display settings compatible?	In the case of HDMI signals, automatic overscan occurs on some displays. Change the display's settings.	—
Compositing a logo or video cannot be accomplished.	Has the correct key type (extraction color) been selected for DSK?	Go to the DSK menu and use "KEY TYPE" to select the key type (extraction color) to match the background color of the logo or video.	p. 27
		Use the "LEVEL" parameter and "GAIN" parameter to adjust the position to just the right degree of extraction for the logo or image.	
Still-image cannot be imported.	Are you importing a still image whose format and resolution are supported by the XS-62S?	Still images of unsupported formats or resolutions are not recognized. Prepare a still image whose format and resolution are supported by the XS-62S.	p. 20
	Does still image have a proper file name?	Use a file name composed of no more than 8 single-byte alphanumeric characters. Also, be sure to append the "*.bmp" file extension. Still images without proper file names are not recognized.	

Problem	Items to check	Action	Page
Audio-related Problems			
No audio is output. Audio volume is low.	Is the volume turned down on the XS-62S?	Adjust each input to an appropriate volume level. Also, use the [MASTER] knob to adjust the volume level for PGM/1 bus.	p. 26
	Is head amp gain turned down for AUDIO IN 1 through 4?	When head amp gain is turned down, no audio is output even when the volume level is raised. Adjust the head amp gain.	p. 25
	Is a condenser microphone connected?	If you want to connect a device that requires a phantom power supply such as condenser mic, use it in conjunction with a power supply box designed for a condenser mic.	—
Other Problems			
Buttons and knobs cannot be operated.	Is panel lock turned on?	When the message "OPERATION LOCKED" is shown on the built-in display, panel lock is turned on. Press and hold the [EXIT] button and the [MENU] button at the same time (for 3 seconds or longer) to turn off panel lock.	p. 36
A USB flash drive cannot be read	Has the USB flash drive been formatted on the XS-62S?	The XS-62S does not recognize unformatted USB flash drives. Format the USB flash drive before using it for the first time.	p. 35

RGB/CMPNT/CMPST IN 6 Connector Specifications

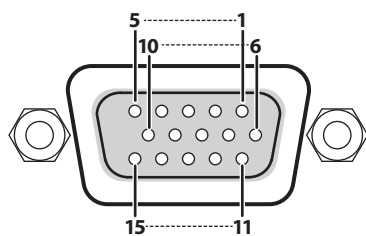

D-Sub 15-pin (female)

Pin #	Input video signal type		
	RGB	Component	Composite
1	Red	Pr/Cr	
2	Green/G on Sync	Y	VIDEO
3	Blue	Pb/Cb	
4			
5	GND		
6	GND	GND	
7	GND	GND	GND
8	GND	GND	
9	DDC +5 V		
10	GND		
11			
12	DDC data		
13	HD		
14	VD		
15	DDC clock		

Block Diagram

Video Section (PGM-PST Mode, DISSOLVE Mode)

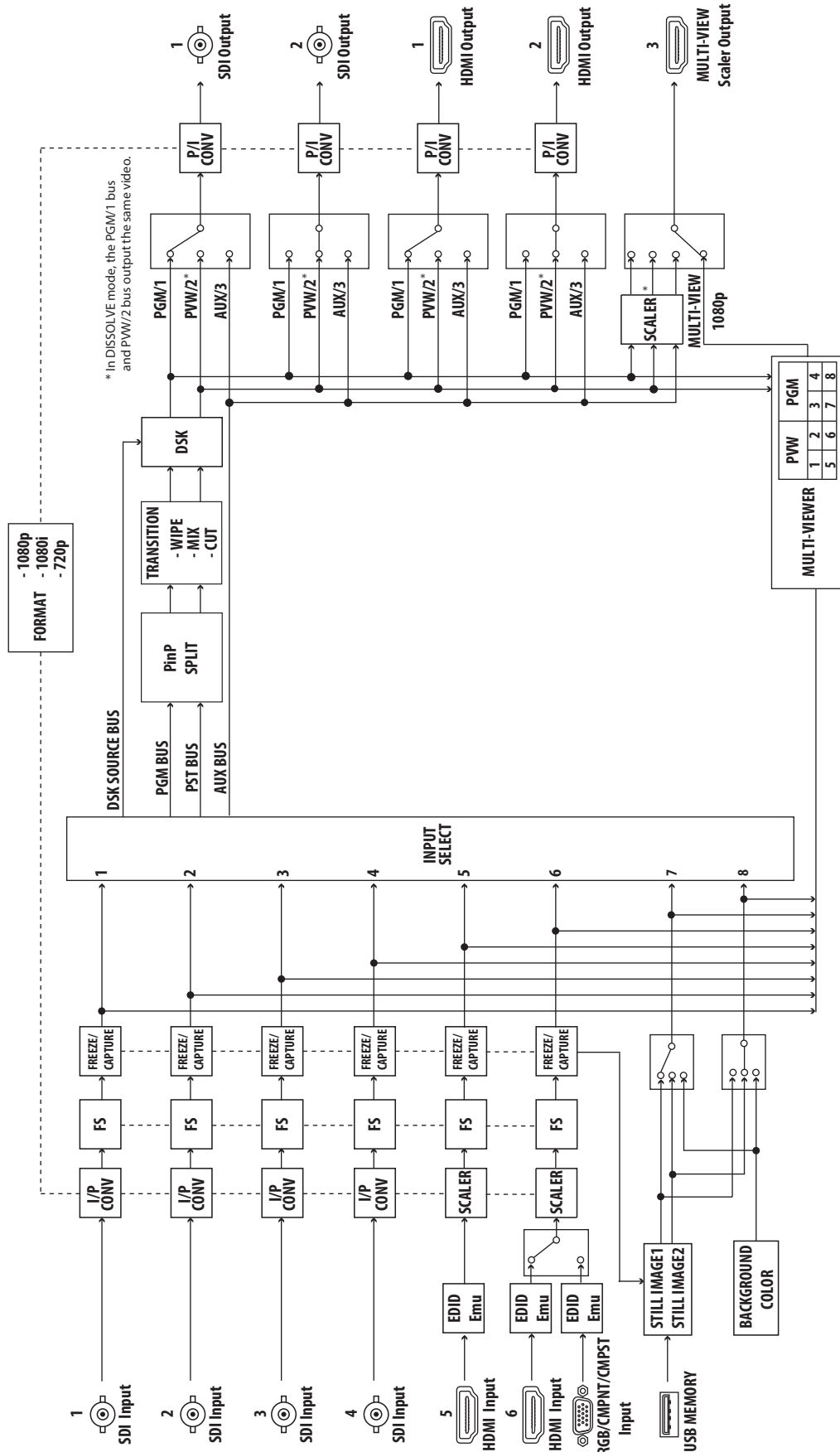

Video Section (MATRIX Mode)

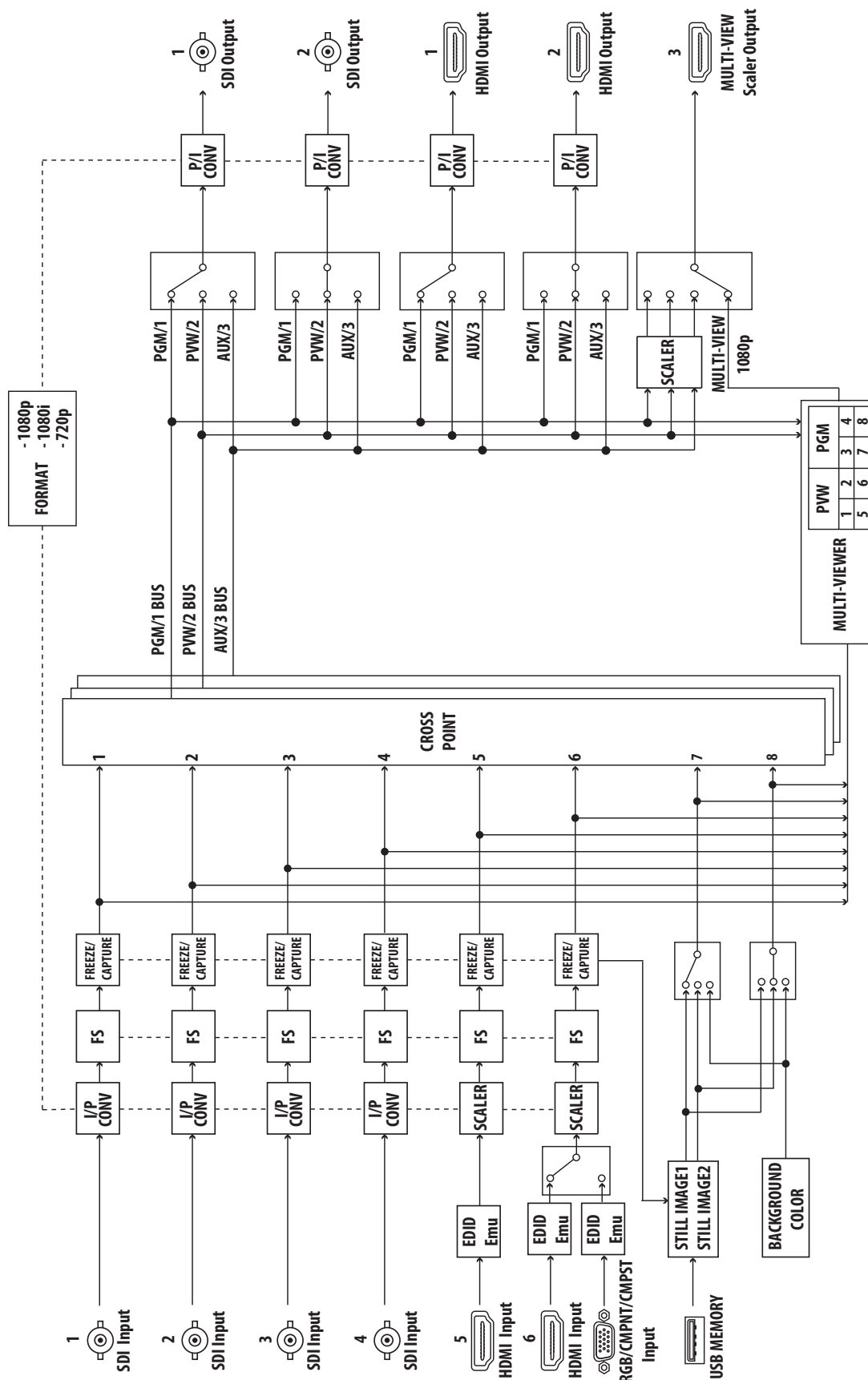

Audio Section

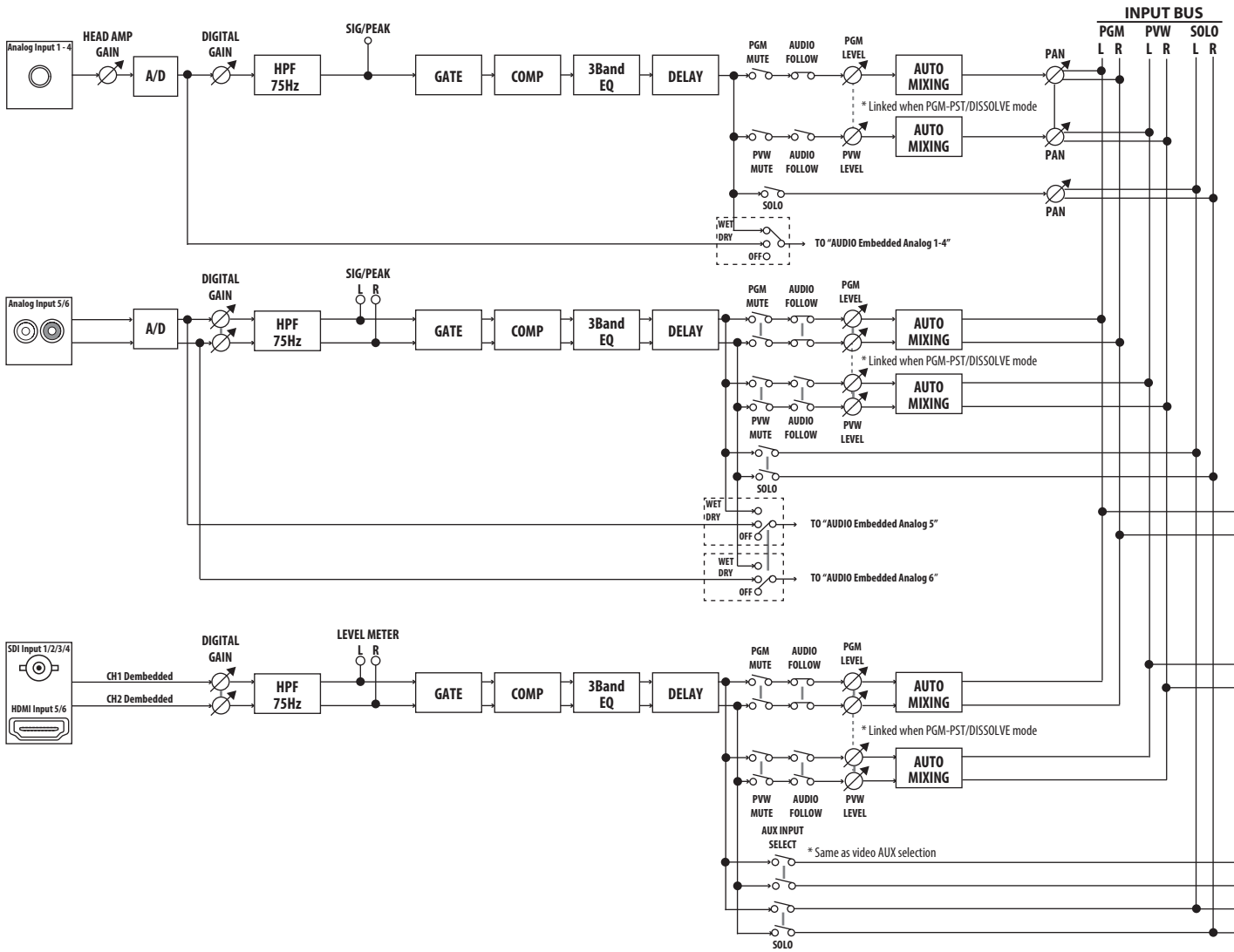

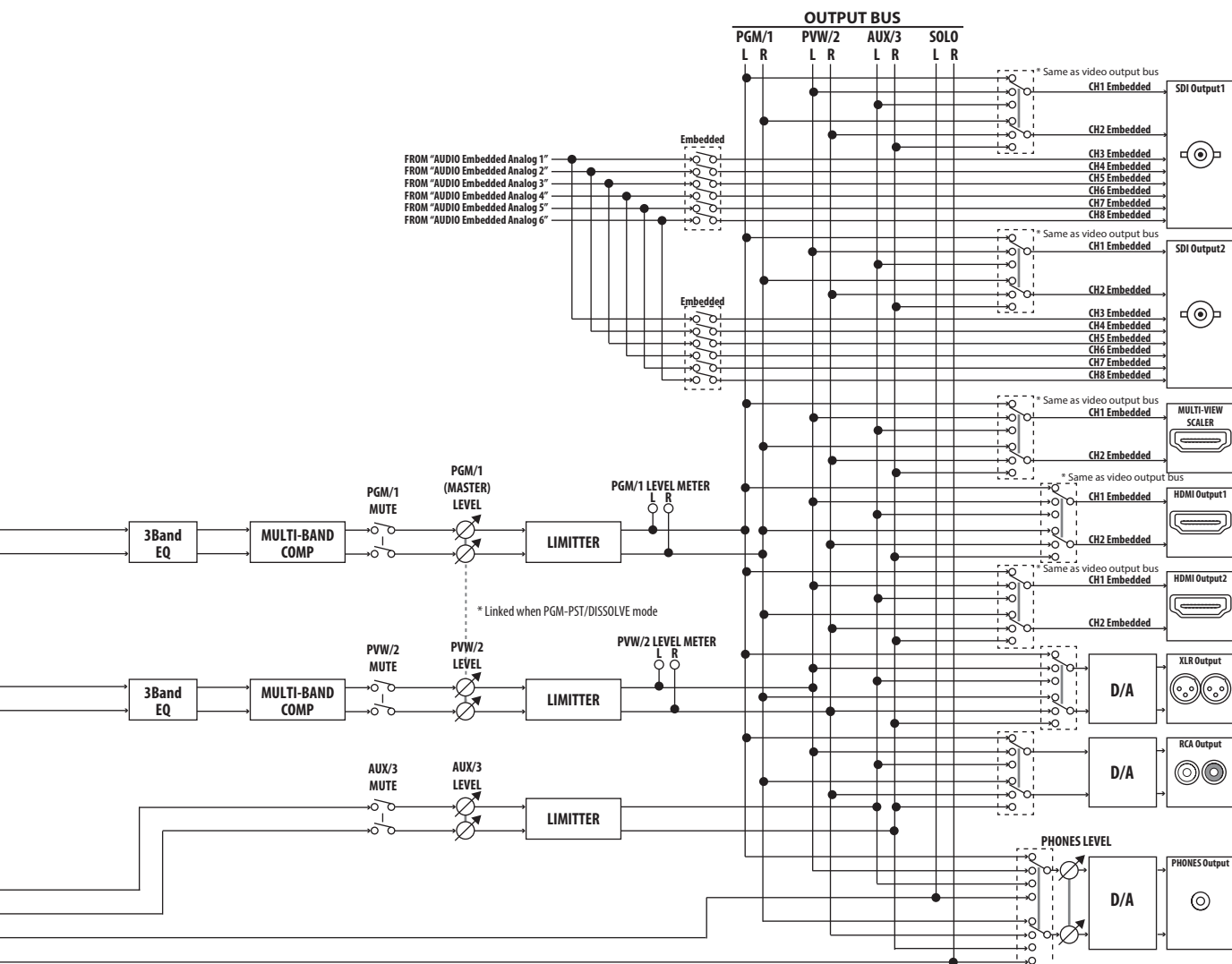























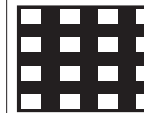

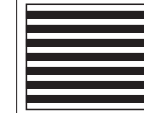

Transition Effects List

MIX

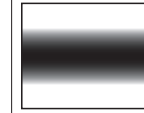
	Effect	Explanation
	MIX	The two pictures are blended together as the video is switched.
	FAM	Video transitions are made with the luminance levels of the two video streams maintained unchanged. This is an abbreviation of "full additive mix."
	NAM	The two video streams are compared, and transitions are made with display during transition starting with levels of high luminance. This is an abbreviation of "non-additive mix."

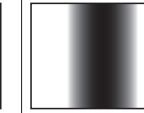
WIPE

The original video is broken into by the next video.

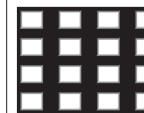
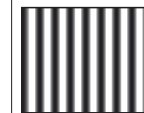
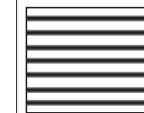
Normal							
H-DOWN	H-UP	V-RIGHT	V-LEFT	H-IN	H-OUT	V-IN	V-OUT
							
R-DOWN	L-DOWN	R-UP	L-UP	BLOCK	V-GRID	H-GRID	
							
Soft Edge							
H-DOWN s	H-UP s	V-RIGHT s	V-LEFT s	H-IN s	H-OUT s	V-IN s	V-OUT s
							
R-DOWN s	L-DOWN s	R-UP s	L-UP s	BLOCK s	V-GRID s	H-GRID s	
							

Main Specifications

Roland XS-62S: HD Video Switcher

Video			
Video Processing	4:2:2 (Y/Pb/Pr), 8-bit		
Input Connectors	SDI IN 1–4 connectors *3	BNC type x 4	
	HDMI IN 5–6 connectors *4 *5	HDMI type A x 2	
	RGB/CMPNT/CMPST IN 6 connector *5	HD DB-15 type x 1 Select either HDMI, RGB/COMPONENT, or COMPOSITE for the INPUT 6 connector.	
Output Connectors	SDI OUT 1–2 connectors *3	BNC type x 2	
	HDMI OUT 1–3 connectors *4	HDMI type A x 3	
Analog Input Level, Impedance	RGB	0.7 Vp-p, 75 Ω (H, V: 5 V TTL)	
	COMPONENT	1.0 Vp-p, 75 Ω (Bi-level sync/Tri-level sync)	
	COMPOSITE	1.0 Vp-p (Y), 0.286 Vp-p (C: NTSC), 0.3 Vp-p (C: PAL), 75 Ω	
Input Formats *1 *2	SDI IN 1–4 connectors *6	SYSTEM FORMAT 720p	720/59.94p, 720/50p
		SYSTEM FORMAT 1080i or 1080p	1080/59.94i, 1080/50i 1080/59.94p, 1080/50p
	HDMI IN 5–6 connectors, RGB/CMPNT/CMPST IN 6 connector (When inputting RGB or COMPONENT signals)	480/59.94i, 576/50i, 480/59.94p, 576/50p, 720/59.94p, 720/50p, 1080/59.94i, 1080/50i, 1080/59.94p, 1080/50p	
		VGA (640 x 480, 60 Hz), SVGA (800 x 600, 60 Hz), XGA (1024 x 768, 60 Hz), WXGA (1280 x 800, 60 Hz), SXGA (1280 x 1024, 60 Hz), FWXGA (1366 x 768, 60 Hz), SXGA+ (1400 x 1050, 60 Hz), UXGA (1600 x 1200, 60 Hz), WUXGA (1920 x 1200, 60 Hz) The refresh rate is the maximum value of each resolution. Conforms to CEA-861-E, VESA DMT Version 1.0 Revision 11. 1920 x 1200, 60 Hz: Reduced blanking	
		480/59.94i, 576/50i	
RGB/CMPNT/CMPST IN 6 connector (When inputting COMPOSITE signals)	480/59.94i, 576/50i		
Still Image	Bitmap File (.bmp) Maximum 1920 x 1080 pixels, 24-bit color, uncompressed. It can be stored up to 2 files in the internal memory.		
Output Formats *2	SDI OUT 1–2 connectors *6, HDMI OUT 1–2 connectors	SYSTEM FORMAT 720	720/59.94p, 720/50p
		SYSTEM FORMAT 1080i	1080/59.94i, 1080/50i
		SYSTEM FORMAT 1080p	1080/59.94p, 1080/50p
	HDMI OUT 3 connector *2 *7	HDMI MULTI-VIEW	1080/59.94p, 1080/50p
		HDMI Scaler	480/59.94p, 576/50p, 720/59.94p, 720/50p, 1080/59.94p, 1080/50p, SVGA (800 x 600, 60 Hz), XGA (1024 x 768, 60 Hz *8), WXGA (1280 x 800, 60 Hz *8), SXGA (1280 x 1024, 60 Hz *8), FWXGA (1366 x 768, 60 Hz *8), SXGA+ (1400 x 1050, 60 Hz *8), UXGA (1600 x 1200, 60 Hz), WUXGA (1920 x 1200, 60 Hz)
Video Effects	Transition *9	CUT, MIX (DISSOLVE/FAM/NAM), WIPE (30 types)	
	Composition *9	PinP (SQUARE, CIRCLE, HEART, DIAMOND), SPLIT (4 types), DSK (Luminance Key, Chroma Key)	
	Others	Flip horizontal, Still image capture, Still image playback, Test pattern output, Input freeze	
<p>(*1) The input interlaced video signal is converted to progressive video signal by internal processing.</p> <p>(*2) The video signal frame rate can be selected at the SYSTEM menu (59.94 Hz or 50 Hz).</p> <p>(*3) Conforms to SMPTE 424M (SMPTE 425M-AB), 292M</p> <p>(*4) HDCP Supported</p> <p>(*5) Multi-format Supported</p> <p>(*6) Conforms to SMPTE 296M, 274M</p> <p>(*7) Select either MULTI-VIEW or scaling output</p> <p>(*8) Output refresh rate is 75 Hz when frame rate is set to 50 Hz.</p> <p>(*9) These effects depend on Output Mode.</p>			

■ Audio			
Audio Processing	Sample rate	48 kHz, 24 bits	
Audio Formats	SDI IN connectors	Linear PCM, 48 kHz, 24 bits, 2ch (Conforms to SMPTE 299M)	
	SDI OUT connectors	Linear PCM, 48 kHz, 24 bits, 2ch (Conforms to SMPTE 299M)	
	HDMI IN connectors, HDMI OUT connectors	Linear PCM, 48 kHz, 24 bits, 2ch	
Input Connectors	Digital	SDI IN 1–4 connectors	BNC type x 4
		HDMI IN 5–6 connectors	HDMI type A x 2
	Analog	AUDIO IN 1–4 jacks	1/4-inch TRS phone type
		AUDIO IN 5–6 connectors	RCA phono type
Output Connectors	Digital	SDI OUT 1–2 connectors	BNC type x 2
		HDMI OUT 1–3 connectors	HDMI type A x 3
	Analog	AUDIO OUT connectors/ jacks	XLR type, RCA phono type
		PHONES jack	Stereo 1/4-inch phone type
Nominal Input Level	AUDIO IN 1–4 jacks	-60+4 dBu (Maximum: +22 dBu)	
	AUDIO IN 5–6 jacks	-10 dBu (Maximum: +8 dBu)	
Input Impedance	AUDIO IN 1–4 jacks	28 kΩ (HEAD AMP GAIN: 0–+23 dBu), 8 kΩ (HEAD AMP GAIN: +24–+64 dBu)	
	AUDIO IN 5–6 jacks	15 kΩ	
Nominal Output Level	AUDIO OUT connectors (XLR)	+4 dBu (Maximum: +22 dBu)	
	AUDIO OUT jacks (RCA phono)	-10 dBu (Maximum: +8 dBu)	
	PHONES jack	92 mW + 92 mW (32 Ω)	
Output Impedance	AUDIO OUT connectors (XLR)	600 Ω	
	AUDIO OUT jacks (RCA phono)	1 kΩ	
	PHONES jack	10 Ω	
Audio Effects	Auto Mixing, EQ, Delay, Compressor, HPF, Gate, Multi-Band Compressor, Limiter		
■ Common			
Connectors	USB MEMORY port	USB A type (For USB flash drive)	
	TALLY/GPIO connector	DB-25 type (Female)	
	RS-232 connector	DB-9 type (Male, for Remote Control)	
	RS-422 connector	DB-9 type (Female, for Camera Control)	
	CONTROL connector	RJ45 100BASE-TX (For Remote Control)	
	DC IN		
Functions	MEMORY (8 types), Panel Lock Function, EDID Emulator, Smart Tally, Remort Camera Control		
Display	Graphic LCD: 128 x 64 dots		
Power Supply	AC adaptor		
Current Draw	2.6 A		
Power Consumption	31.0 W		
Dimensions	481 (W) x 333 (D) x 44 (H) mm 18-15/16 (W) x 13-1/8 (D) x 1-3/4 (H) inches		
Weight (excluding AC adaptor)	3.6 kg 7 lbs 15 oz		
Accessories	Owner's Manual, AC adaptor, Power cord, Rubber feet (4 pcs.)		

* 0 dBu = 0.775 Vrms

* This document explains the specifications of the product at the time that the document was issued. For the latest information, refer to the Roland website.

Dimensions

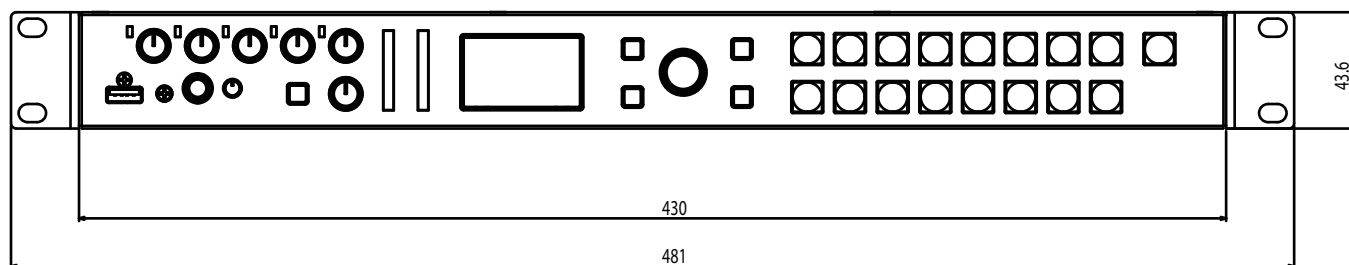
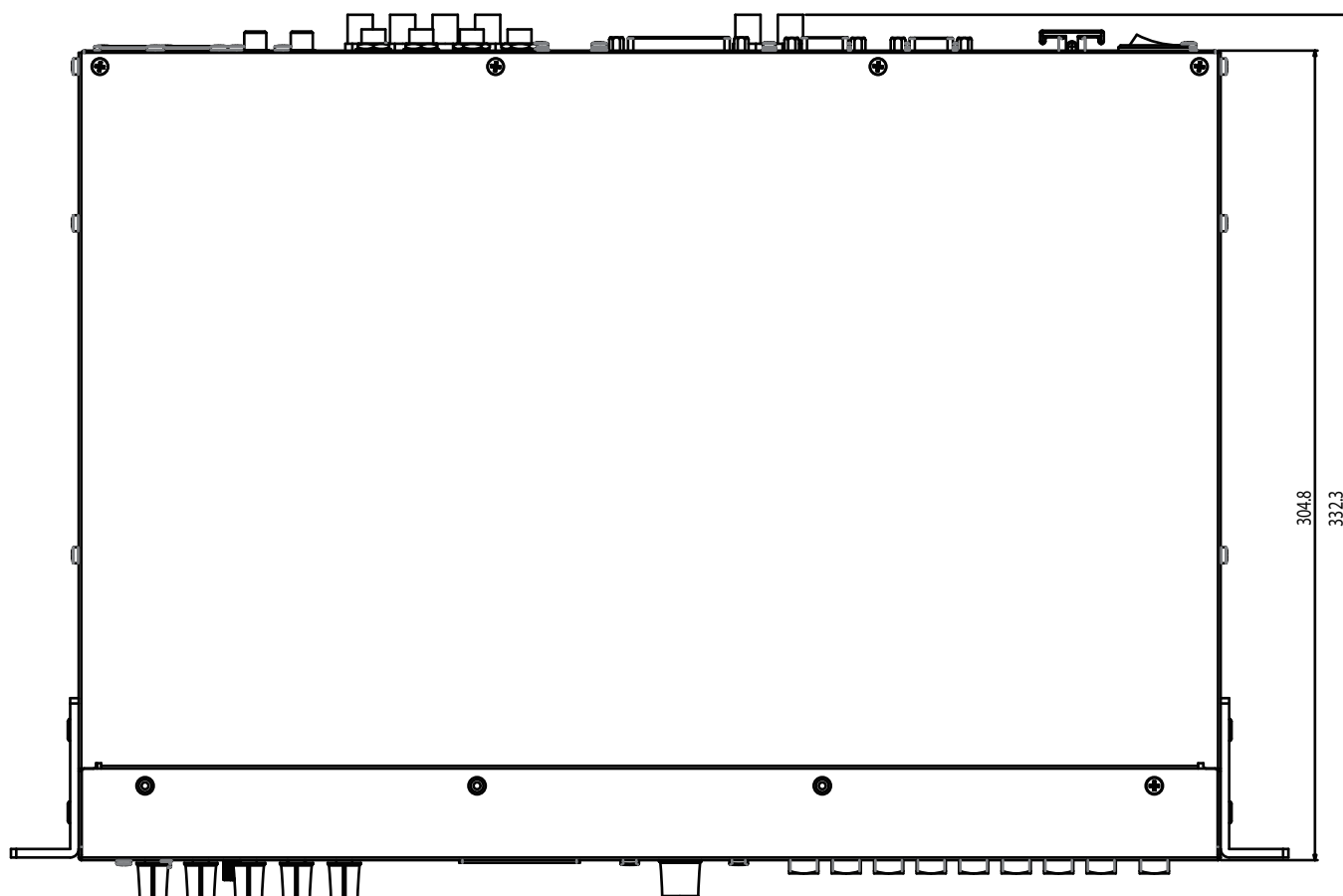

For EU Countries



- UK** This symbol indicates that in EU countries, this product must be collected separately from household waste, as defined in each region. Products bearing this symbol must not be discarded together with household waste.
- DE** Dieses Symbol bedeutet, dass dieses Produkt in EU-Ländern getrennt vom Hausmüll gesammelt werden muss gemäß den regionalen Bestimmungen. Mit diesem Symbol gekennzeichnete Produkte dürfen nicht zusammen mit dem Hausmüll entsorgt werden.
- FR** Ce symbole indique que dans les pays de l'Union européenne, ce produit doit être collecté séparément des ordures ménagères selon les directives en vigueur dans chacun de ces pays. Les produits portant ce symbole ne doivent pas être mis au rebut avec les ordures ménagères.
- IT** Questo simbolo indica che nei paesi della Comunità europea questo prodotto deve essere smaltito separatamente dai normali rifiuti domestici, secondo la legislazione in vigore in ciascun paese. I prodotti che riportano questo simbolo non devono essere smaltiti insieme ai rifiuti domestici. Ai sensi dell'art. 13 del D.Lgs. 25 luglio 2005 n. 151.
- ES** Este símbolo indica que en los países de la Unión Europea este producto debe recogerse aparte de los residuos domésticos, tal como esté regulado en cada zona. Los productos con este símbolo no se deben depositar con los residuos domésticos.
- PT** Este símbolo indica que nos países da UE, a recolha deste produto deverá ser feita separadamente do lixo doméstico, de acordo com os regulamentos de cada região. Os produtos que apresentem este símbolo não deverão ser eliminados juntamente com o lixo doméstico.
- NL** Dit symbool geeft aan dat in landen van de EU dit product gescheiden van huishoudelijk afval moet worden aangeboden, zoals bepaald per gemeente of regio. Producten die van dit symbool zijn voorzien, mogen niet samen met huishoudelijk afval worden verwijderd.
- DK** Dette symbol angiver, at i EU-lande skal dette produkt opsamles adskilt fra husholdningsaffald, som defineret i hver enkelt region. Produkter med dette symbol må ikke smides ud sammen med husholdningsaffald.
- NO** Dette symbolet indikerer at produktet må behandles som spesialavfall i EU-land, iht. til retningslinjer for den enkelte regionen, og ikke kastes sammen med vanlig husholdningsavfall. Produkter som er merket med dette symbolet, må ikke kastes sammen med vanlig husholdningsavfall.

- SE** Symbolen anger att i EU-länder måste den här produkten kasseras separat från hushållsavfall, i enlighet med varje regions bestämmelser. Produkter med den här symbolen får inte kasseras tillsammans med hushållsavfall.
- FI** Tämä merkintä ilmaisee, että tuote on EU-maissa kerättävä erillään kotitalousjätteistä kunkin alueen voimassa olevien määräysten mukaisesti. Tällä merkinnällä varustettuja tuotteita ei saa hävittää kotitalousjätteiden mukana.
- HU** Ez a szimbólum azt jelenti, hogy az Európai Unióban ezt a terméket a háztartási hulladéktól elkülönítve, az adott régióban érvényes szabályozás szerint kell gyűjteni. Az ezzel a szimbóllummal ellátott termékeket nem szabad a háztartási hulladék közé dobni.
- PL** Symbol oznacza, że zgodnie z regulacjami w odpowiednim regionie, w krajach UE produktu nie należy wyrzucać z odpadami domowymi. Produktów opatrzonych tym symbolem nie można utylizować razem z odpadami domowymi.
- CZ** Tento symbol udává, že v zemích EU musí být tento výrobek sbírán odděleně od domácího odpadu, jak je určeno pro každý region. Výrobky nesoucí tento symbol se nesmí vyhazovat spolu s domácím odpadem.
- SK** Tento symbol vyjadruje, že v krajinách EÚ sa musí zber tohto produktu vykonávať oddelene od domového odpadu, podľa nariadení platných v konkrétnej krajine. Produkty s týmto symbolom sa nesmú vyhazovať spolu s domovým odpadom.
- EE** See sümbol näitab, et EL-i maades tuleb see toode olemprügist eraldi koguda, nii nagu on igas piirkonnas määratletud. Selle sümboliga märgitud tooteid ei tohi ära visata koos olmeprügiga.
- LT** Šis simbolis rodo, kad ES šalyse šis produktas turi būti surenkamas atskirai nuo buitinių atliekų, kaip nustatyta kiekviename regione. Šiuo simboliu paženklinėti produktai neturi būti išmetami kartu su buitiniomis atliekomis.
- LV** Šis simbols norāda, ka ES valstīs šo produktu jāievāc atsevišķi no mājsaimniecības atkritumiem, kā noteikts katrā reģionā. Produktus ar šo simbolu nedrīkst izmest kopā ar mājsaimniecības atkritumiem.
- SI** Ta simbol označuje, da je treba proizvod v državah EU zbirati ločeno od gospodinjskih odpadkov, tako kot je določeno v vsaki regiji. Proizvoda s tem znakom ni dovoljeno odlagati skupaj z gospodinjskimi odpadki.
- GR** Το σύμβολο αυτό υποδηλώνει ότι στις χώρες της Ε.Ε. το συγκεκριμένο προϊόν πρέπει να συλλέγεται χωριστά από τα υπόλοιπα οικιακά απορρίμματα, σύμφωνα με όσα προβλέπονται σε κάθε περιοχή. Τα προϊόντα που φέρουν το συγκεκριμένο σύμβολο δεν πρέπει να απορρίπτονται μαζί με τα οικιακά απορρίμματα.

For China

有关产品中所含有害物质的说明

本资料就本公司产品中所含的特定有害物质及其安全性予以说明。
本资料适用于2007年3月1日以后本公司所制造的产品。

环保使用期限



此标志适用于在中国国内销售的电子信息产品，表示环保使用期限的年数。所谓环保使用期限是指在自制造日起的规定的期限内，产品中所含的有害物质不致引起环境污染，不会对人身、财产造成严重的不良影响。
环保使用期限仅在遵照产品使用说明书，正确使用产品的条件下才有效。
不当的使用，将会导致有害物质泄漏的危险。

产品中有毒物质的名称及含量

部件名称	有害物质					
	铅(Pb)	汞(Hg)	镉(Cd)	六价铬(Cr(VI))	多溴联苯(PBB)	多溴二苯醚(PBDE)
外壳(壳体)	×	○	○	○	○	○
电子部件(印刷电路板等)	×	○	×	○	○	○
附件(电源线、交流适配器等)	×	○	○	○	○	○

本表格依据SJ/T 11364的规定编制。

○: 表示该有害物质在该部件所有均质材料中的含量均在GB/T 26572 规定的限量要求以下。

×: 表示该有害物质至少在该部件的某一均质材料中的含量超出GB/T 26572的限量要求。

(企业可在此处, 根据实际情况对上表中打“×”的技术原因进行进一步说明。)

