

BZ-MVS8x8-4K

**8X8 4K UHD 18Gbps HDMI Video Wall Processor & Seamless
Matrix Switcher with Scaler, IR, and Audio**

User Manual







TABLE OF CONTENTS

Safety Precaution	4
Introduction	5
Features	5
Packing List	5
Specifications	6
Operation Controls and Functions	7
PC Tool and RS232/LAN Control	9
UART Control	11
Network Control	12
Connection via LAN	14
Configure the Network of the Device via UART	14
Configure the Network of the Device via LAN	15
Matrix Switch	16
Signal Setting	17
EDID Control	17
Control via Web	18
Tech Support	19
Warranty	19
Mission Statement	20
Copyright	20



Statement

Please read these instructions carefully before connecting, operating, or configuring this product. Please save this manual for future reference.

Safety Precaution

- To prevent damaging this product, avoid heavy pressure, strong vibration, or immersion during transportation, storage, and installation.
- The housing of this product is made of organic materials. Do not expose to any liquid, gas, or solids which may corrode the shell.
- Do not expose the product to rain or moisture.
- Unplug this device during lightning storms
- Clean only with a soft dry microfiber cloth.
- To prevent the risk of electric shock, do not open the case. Installation and maintenance should only be carried out by qualified technicians.
- Do not use the product beyond the specified temperature, humidity, or power supply specifications.
- This product does not contain parts that can be maintained or repaired by users. Damage caused by dismantling the product without authorization from BZBGear is not covered under the warranty policy.
- Installation and use of this product must strictly comply with local electrical safety standards.
- Only use accessories specified by the manufacture
- Product specifications may be subject to technical upgrades without further notice



Introduction

The BZ-MVS8x8-4K matrix and video wall processor is an incredible tool for anyone seeking a matrix switcher that can support eight inputs and eight outputs. The device can support multiple video walls simultaneously in various configurations such as a 1x2, 2x2, 2x3, etc. up to 8 displays total. This enables commercial-grade video walls with 4K HDR quality. IR matrix routing is also available on this unit via IR extenders through the 8 IR inputs and outputs.

Features

- HDMI 2.0/HDCP 2.2
- Seamless switching
- IR matrix
- HDMI audio extraction
- External L/R audio embedding to HDMI streams
- EDID management
- HDMI video output resolution:
3840x2160@60, 3840x2160@30, 1920x1080@60, 1280x720@60,
1920x1200@60, 1360x768@60, 1280x1024@60, 1024x768@60
- Control through the front panel, RS232, and TCP/IP (LAN 10M/100M)

Packing List

- 1x BZ-MVS8X8-4K
- 1x BZ-MVS8X8-4K User Manual
- 1x AC Power Cord
- 1x Remote Control
- 1x RS-232 / USB Cable



Specifications

Electrical parameters	
Interface	HDMI-A
HDMI /DP /VGA Version	HDMI 2.0, HDCP 2.2
Bandwidth	18Gbps
Video Resolution	
Input	800x600@60Hz, 1024x768@60Hz, 1280x768@60Hz, 1280x800@60Hz, 1280x1024@60Hz, 1360x768@60Hz, 1366x768@60Hz, 1400x1050@60Hz, 1440x900@60Hz, 1600x1200@60Hz, 1680x1050@60Hz, 1920x1200@60Hz. 480p,576p,720p, 1920x1080i, 1920x1080p, 3840x2160@24Hz/25Hz/30Hz/50Hz/60Hz, 4096x2160@24Hz/25Hz/30Hz/50Hz/60Hz
Output	1920x1080@60Hz, 3840x2160@30Hz, 3840x2160@60Hz, 1280x720@60Hz, 1024x768@60Hz, 1360x768@60Hz, 1600x1200@60Hz, 1920x1200@60Hz
HDMI Amplitude	T.M.D.S +/- 0.4Vpp
Differential impedance	100±15ohm
RS232/Ethernet control	
Baud rate and protocol	Baud rate: 9600, data bit: 8 stop bit: 1, no parity checking
Ethernet	IE 10.0+, HTML5
Power	
Max Consumption	100W, 110-240VAC
Matrix Mechanical dimensions	
Size(mm)	17"(L) x 11.8"(W) x 1.7"(H) [430(L) x 300(W) x 44(H) mm]
Weight	11 lbs [5kg]
Other	
Operating temperature	32°F ~ 104°F / 0°C ~ 40°C
Storage temperature	-4°F ~ 158°F / -20°C ~ 70°C
Permissible humidity	10%-50%



Operation Controls and Functions

Front Panel Control

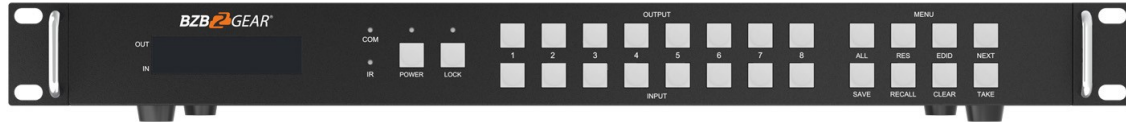

OUTPUT/INPUT buttons

- Press the OUTPUT # + INPUT # + TAKE buttons in sequence to switch the matrix routing
- Press the POWER button to make the matrix enter or exit standby state. When the unit is in standby the power LED will be illuminated.
- Press the LOCK button to lock or unlock the front panel buttons. When locked, the Lock LED will be illuminated.
- Press ALL + INPUT # + TAKE buttons in sequence to switch the selected input # to all of the outputs.
- Press the SAVE + OUTPUT # buttons in sequence to save the current matrix routing as a scene. The maximum allowable number of scenes is 8.
- Press the RECALL + OUTPUT # buttons in sequence to recall a saved scene to be used as the current matrix routing.
- Press the RES + OUTPUT # + NEXT + TAKE buttons in sequence to change the output resolution of the selected OUTPUT # port.
- Resolution Options:
3840x2160@60, 3840x2160@30, 1920x1080@60, 1280x720@60,
1920x1200@60, 1360x768@60, 1280x1024@60, 1024x768@60
- Press the EDID + INPUT # + NEXT + TAKE buttons in sequence to change the EDID mode of the selected INPUT # port.
- EDID Options: Manual, 3840x2160@60, 3840x2160@30, 1280x1024@60,
1920x1080@60, 1280x720@60, 1920x1200@60



Back Panel

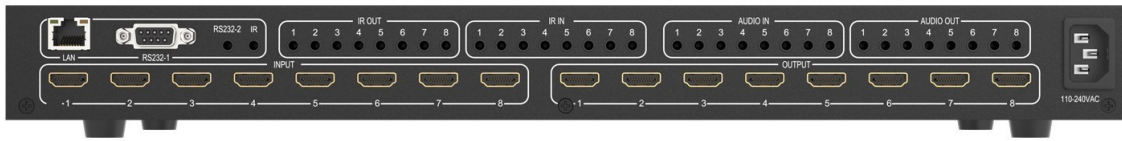

- Control interfaces: LAN (10M/100M), RS232-1/RS232-2, IR
- Analog Audio IN/OUT ports are bonded with corresponding HDMI ports.

For example, if INPUT HDMI 1 signal is DVI, matrix will use analog AUDIO IN 1 as HDMI 1 audio source

Note: Analog AUDIO IN is only available when the corresponding video input is a DVI signal.

Analog AUDIO OUT will always output the same audio content as the corresponding HDMI OUTPUT and Analog Audio IN connection.

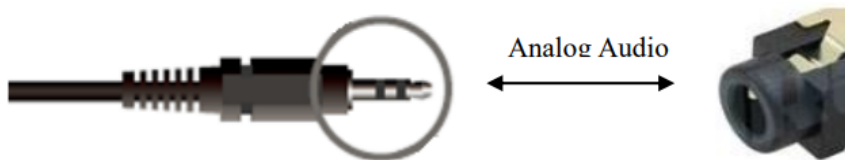

- IR IN and IR OUT

IR IN/OUT is for remote control routing and follows the video routing, for example, if HDMI 1 INPUT is routed to HDMI 1 and 2 OUTPUT ports, then IR IN 1 and 2 will be routed to IR OUT . Please refer to the illustration below.

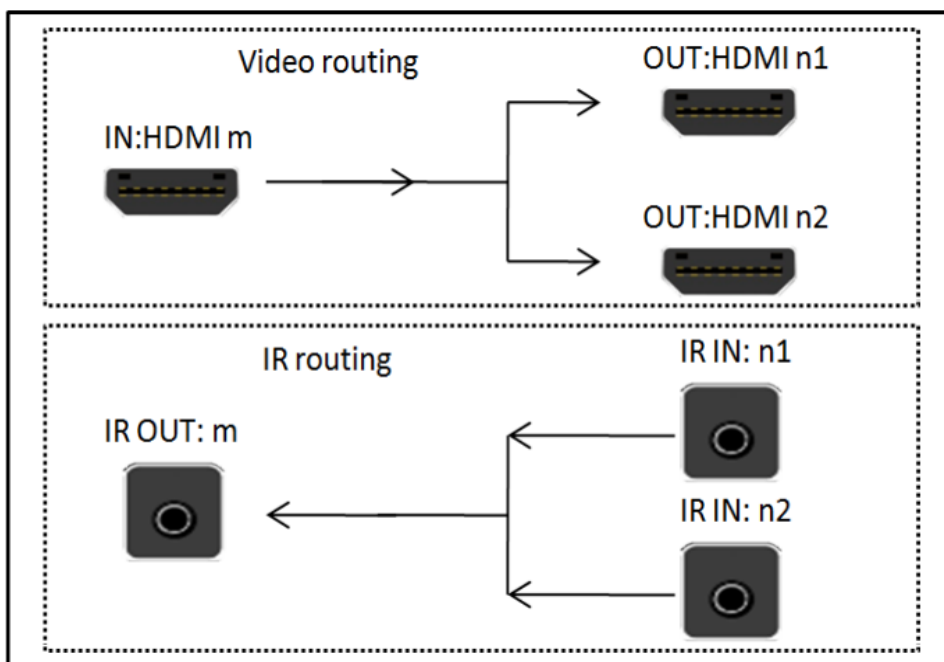



IR extender connectors (not as accessories)

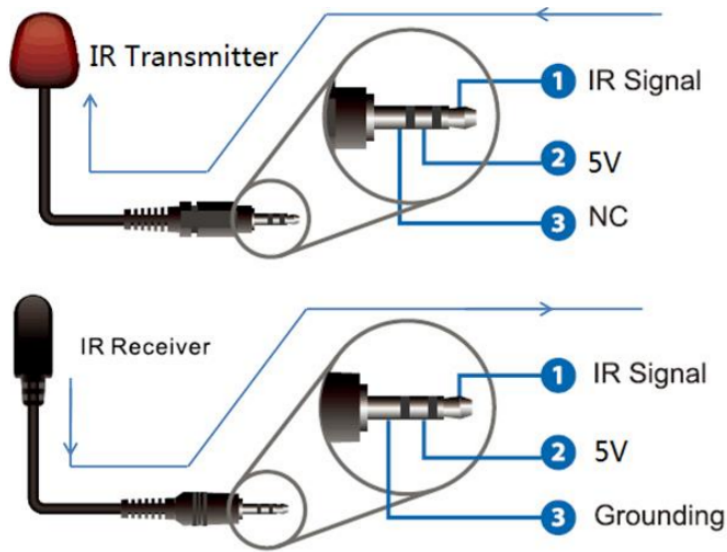

PC Tool and RS232/LAN Control

RS232 connector

- RS-232 control, baud rate 9600, DB9 connector
- Pins configuration as below. User need use the corresponding cable, directly link cable

Index	Pin
1	N/u
2	Tx(Matrix →PC)
3	Rx(Matrix ←PC)
4	N/u
5	Gnd
6	N/u
7	N/u
8	N/u
9	N/u

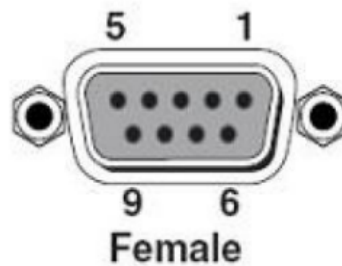



Baud rate 9600

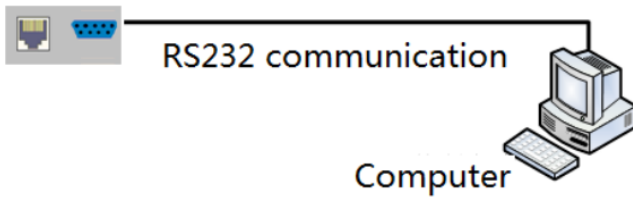

Ethernet control and connection

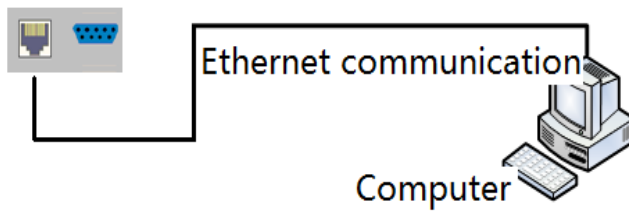

Note: Factory default network setting:

IP Type	Static IP
Static IP	192 . 168 . 0 . 247
Subnet Mask	255 . 255 . 255 . 0
Gateway	192 . 168 . 0 . 1



PC Tool

The PC tool does not need installation as well as supporting serial and network control.

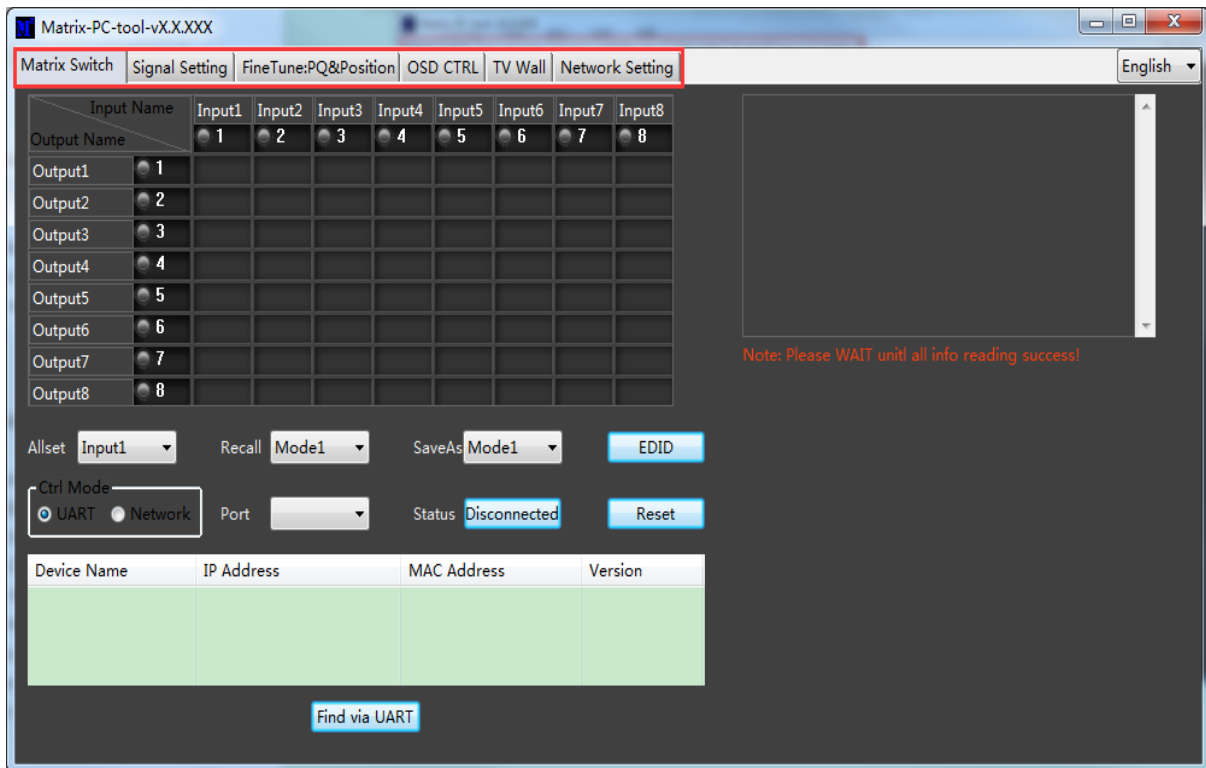

UART Control

Connection via RS232

1. Connect PC and device with a straight serial port cable.
2. Run the PC control tool and select the "Matrix Switch" page.
3. Click the radial in the "Ctrl Mode" section for "UART."
4. Click the "Port" drop down box and select the currently used COM port for the device.
5. Click the "Status" button to establish a connection to the device.
6. If connected successfully, the "Disconnected" button will show "Connected"

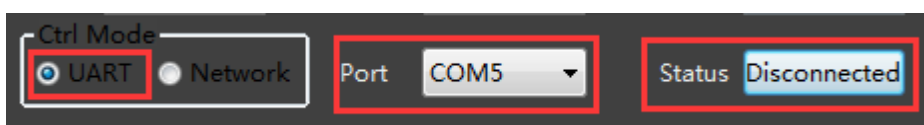



After connecting successfully the UI will display as follows:

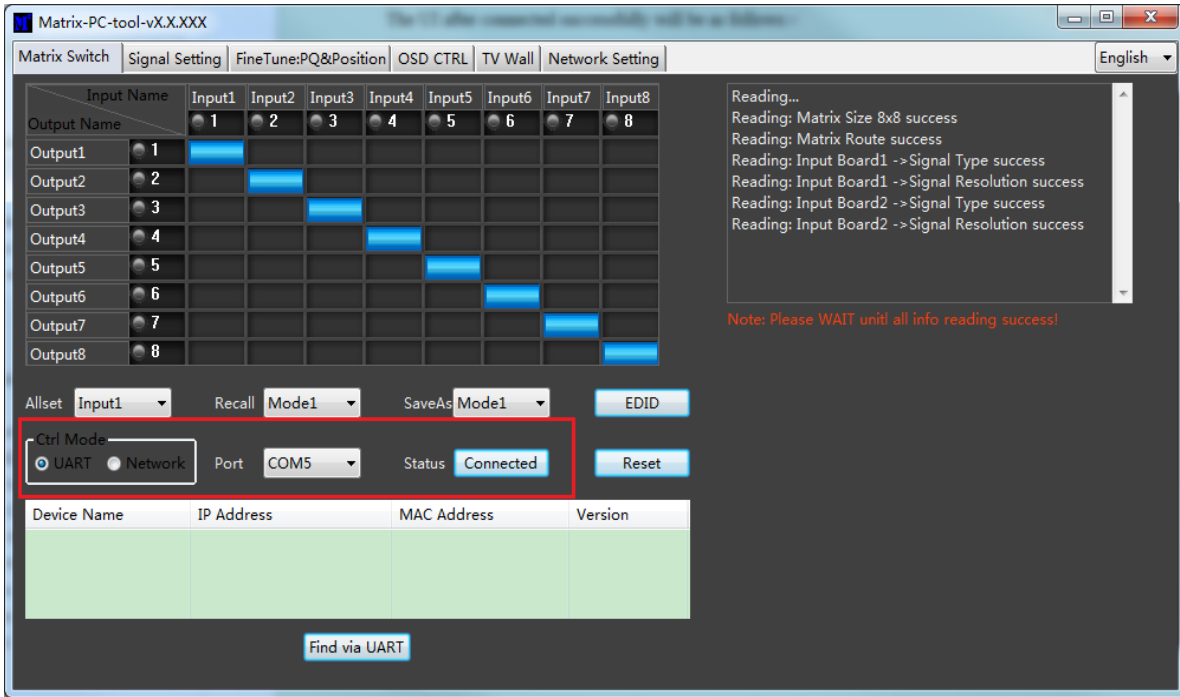

Network Control

Direct connection via Ethernet cable

1. Connect the PC and device directly via an Ethernet cable
2. Change the IP address of the PC to be in the same subnet of the device
 - a) Default IP Address: 192.168.0.247
 - b) Default Subnet Mask: 255.255.255.0

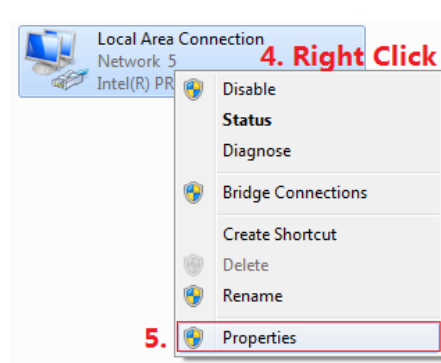
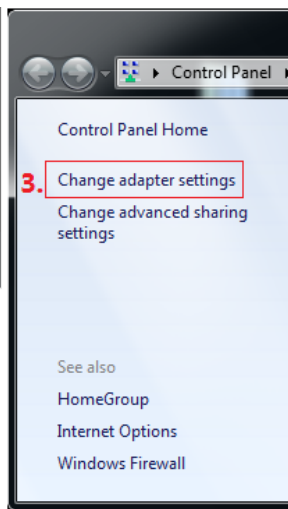
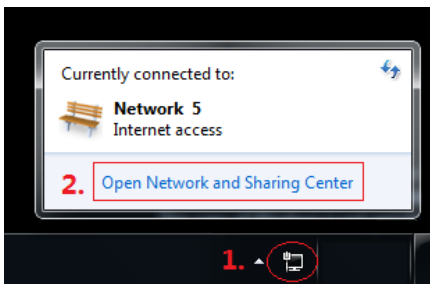

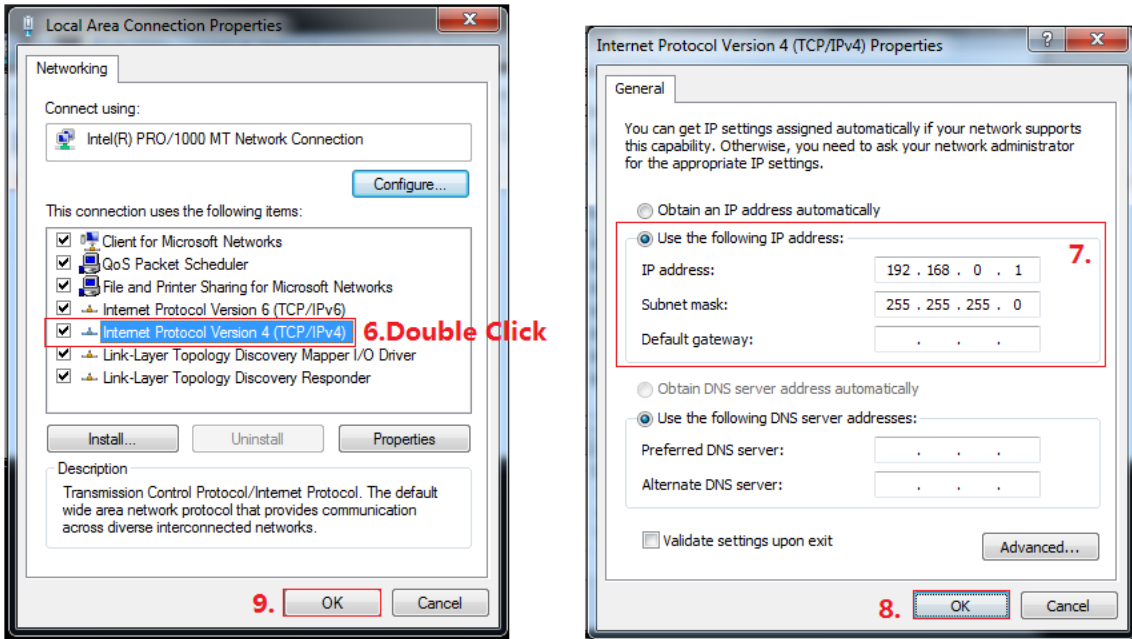

Manually setting up the IP address of the PC

3. Run the PC control software (If you change the IP address of the PC after running the software you will need to close it and run it again).
4. Click to switch "Ctrl Mode" to "Network".
5. Click the "Search Device" button at the bottom.
6. Click the device you want to control in the result list (When you click it, the software will read the network configuration)
7. Click the "Disconnected" button to connect to the device.
8. If connected successfully, the "Disconnected" button will show "Connected."

After connecting successfully the UI will display as follows:

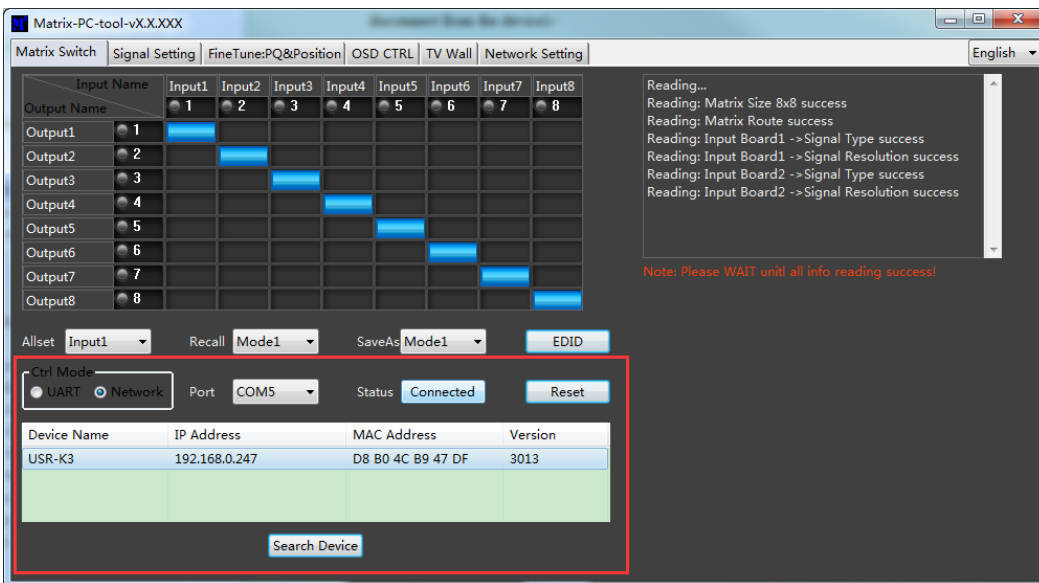



Connection via LAN

1. Connect the PC and the device to the same network.
2. Ensure the IP address of the PC and the device are in the same subnet.
3. Run the PC control software (If you change the IP address of the PC after running the software you will need to close it and run it again).
4. Click to switch the "Ctrl Mode" to "Network."
5. Click the "Search Device" button at the bottom.
6. Click the device you want to control in the result list.
7. Click the 'Disconnected' button to connect to the device.
8. If connected successfully, the "Status" button will show "Connected."

Configure the Network of the Device via UART

1. Connect to the device using a serial cable and configure for UART use as shown above.
2. Select the "Network setting" page.
3. Click the "Find via UART" button to read the configuration of the device.
4. Modify the IP address settings as needed.
5. Click the "Save Config" button to save modifications.
6. When the software shows the message "Success," click the "Find Via UART" button to load the configuration to ensure your modifications saved successfully.

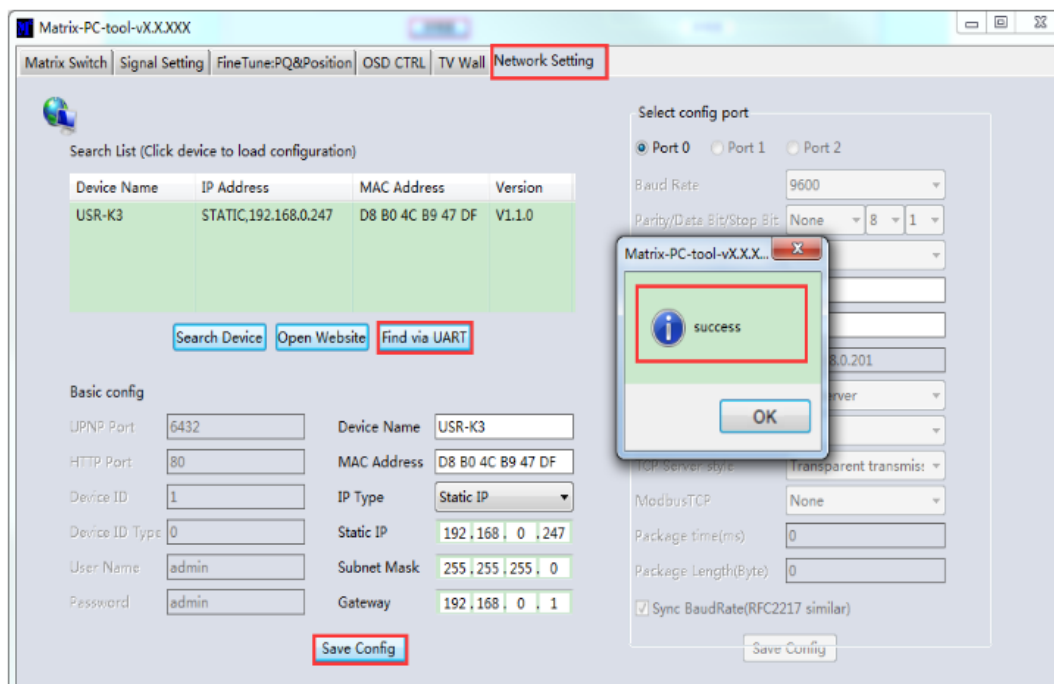



Configure the Network of the Device via LAN

1. Switch the Ctrl Mode to "Network" on the Matrix Switch page as shown above.
2. Click the Network Settings tab and click "Search Device" to search for devices.
3. Click the device you want to configure in the result list
4. Modify the IP address settings as needed.
5. Click the 'Save Config' button to save modifications.
6. When the software shows the message "Success," click the "Search Device" button to search and load the configuration to ensure your modifications saved successfully.

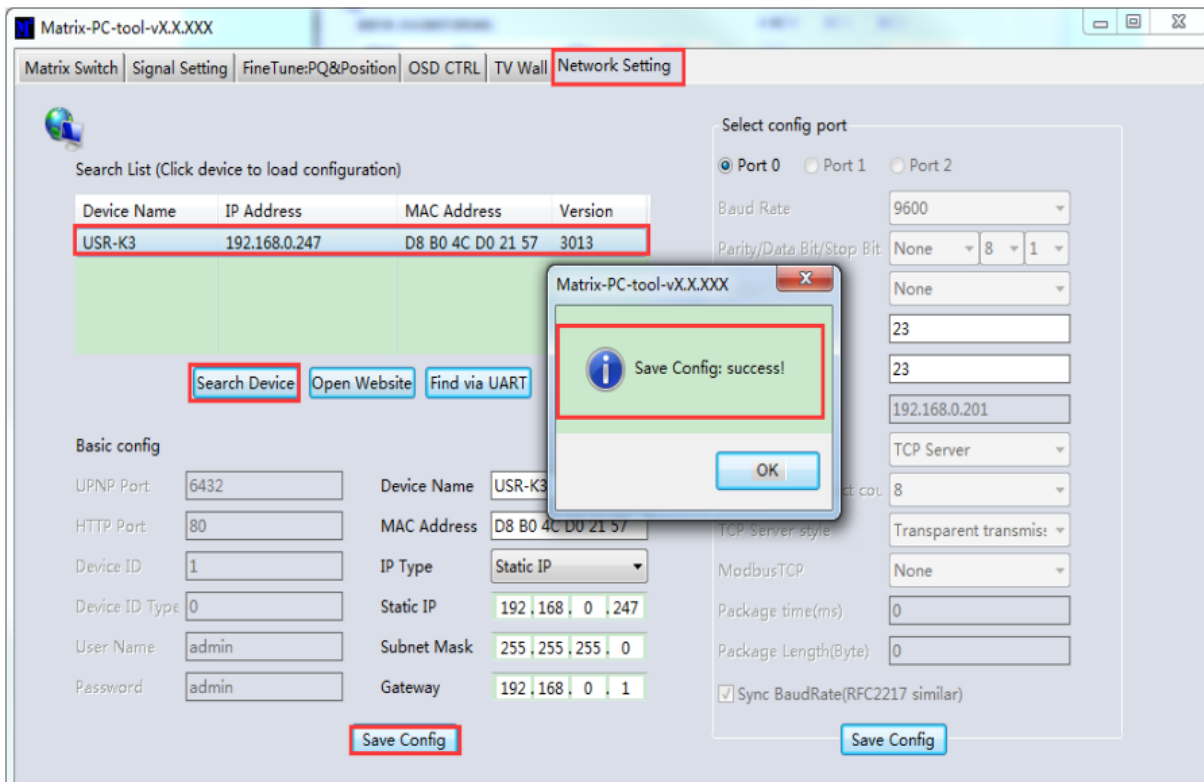

NOTE:

1. Configuration via Network connection allows users to edit the device's name to better identify the matrix. Users can also set the IP type (dynamic/static), subnet mask, gateway, and set the device port. Serial port baud rate is set to 9600 and cannot be changed.
2. Configuration via UART only supports modification of the IP address or IP address type. If you want to modify other settings you will need to connect via Network connection.



Matrix Switch

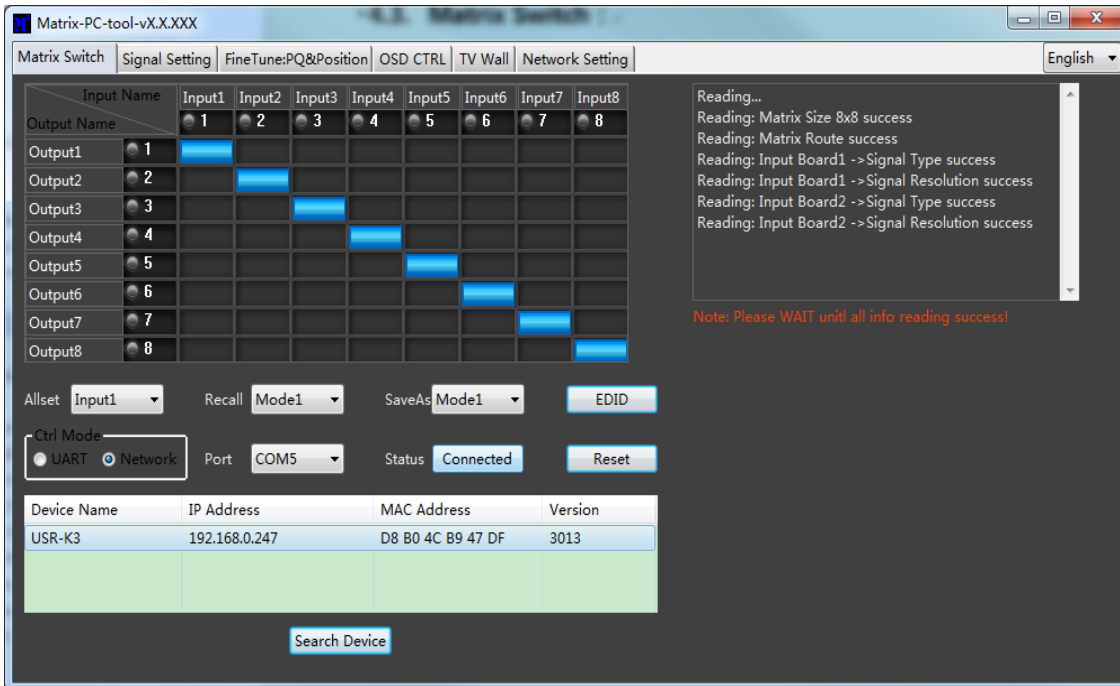

When the PC-tool connects to the matrix via UART or Network, the PC-tool will display the matrix's input and output information.

1. Users can click to switch the input on a selected output.
 - a. Users can change the Input and Output names by clicking the text fields.
2. To save a scene select a mode from the "SaveAs" dropdown (Mode1-Mode8).
3. To recall a scene select a mode from the "Recall" dropdown (Mode1-Mode8).
4. To set one input to all outputs select an input from the "Allset" dropdown.
5. To factory reset the system click the "Reset" button return the device to its factory default settings.



Signal Setting

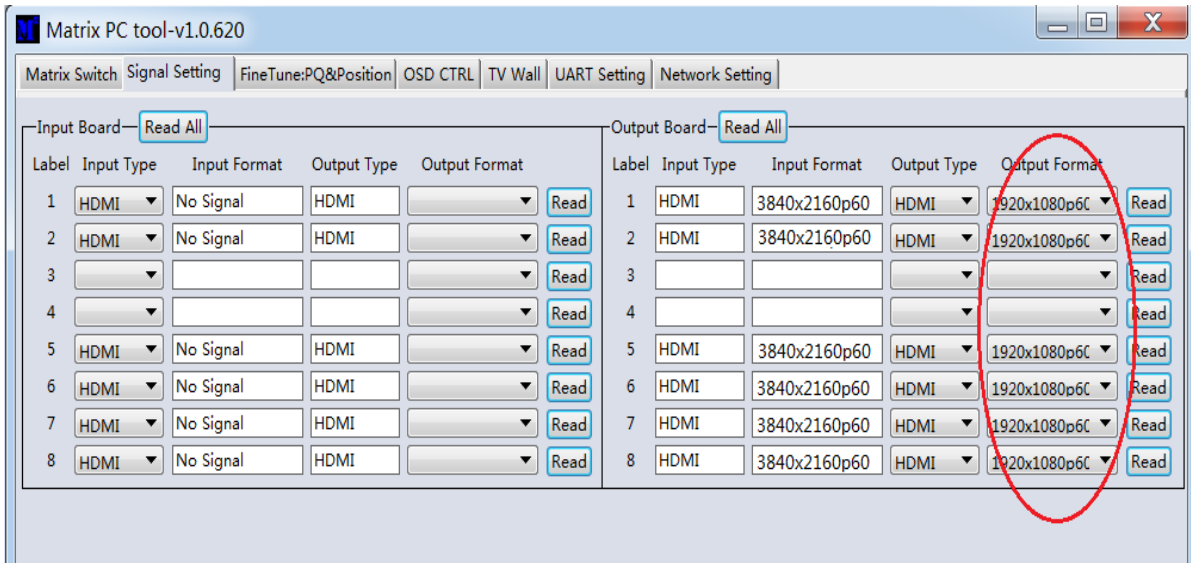

Only the “Output Format” field can be modified; all other fields are read only.

EDID Control

Click the “EDID” button on Matrix Switch page to open the EDID control window.

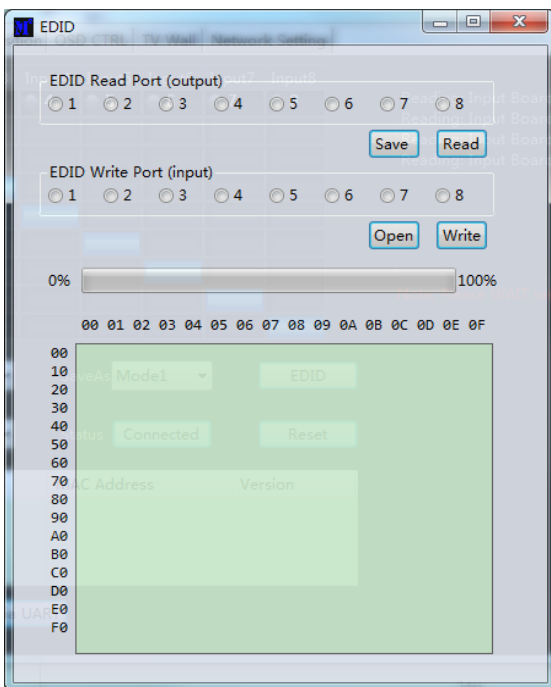

1. Read EDID: Select the output port, then click the "Read " button to read EDID settings.
2. Write EDID: First read an EDID from an output port or open an EDID file that was saved before, select the input port and click the "Write" button to write the EDID.
3. Save EDID: After reading EDID successfully, click the "Save" button and select the save path as well as a file name to save.



Control via Web

If you do not know your devices IP address perform the following (if known, skip to step 4):

1. Click on the Network Settings page
2. Click “Search Device”
3. Select the device that was found and click “Open Website” to open the web control interface
4. If the IP address of the matrix is known, type in the IP address in your web browser.
5. Enter the Username: admin and Password: admin to login and control the device.

NOTE: The computers IP and Matrix IP must be in the same subnet to connect successfully. For example, if the matrix’s IP is 192.168.1.xxx, then the computer IP must also be in the 192.168.1.yyy subnet.

The screenshot shows the 'Matrix-PC-tool vX.X.XXX' application window with the 'Network Setting' tab selected. The interface is divided into several sections:

- Search List:** A table with columns 'Device Name', 'IP Address', 'MAC Address', and 'Version'. One entry is visible: 'USR-K3' with IP '192.168.0.247', MAC 'D8 B0 4C B9 47 DF', and Version '3013'. Below the table are buttons for 'Search Device', 'Open Website', and 'Find via UART'.
- Basic config:** A grid of input fields for:
 - UPNP Port: 6432
 - HTTP Port: 80
 - Device ID: 1
 - Device ID Type: 0
 - User Name: admin
 - Password: admin
 - Device Name: USR-K3
 - MAC Address: D8 B0 4C B9 47 DF
 - IP Type: Static IP
 - Static IP: 192.168.0.247
 - Subnet Mask: 255.255.255.0
 - Gateway: 192.168.0.1
- Select config port:** A panel with radio buttons for 'Port 0' (selected), 'Port 1', and 'Port 2'. It includes dropdowns for Baud Rate (9600), Parity/Data Bit/Stop Bit (None, 8, 1), Stream Control (None), and Device Port (23). It also has input fields for PC Port (23) and PC IP/Domain (192.168.0.201). Other settings include Work Mode (TCP Server), TCP Server connect. col. (8), TCP Server style (Transparent transmis:), ModbusTCP (None), Package time(ms) (0), and Package Length(Byte) (0). A checkbox for 'Sync BaudRate(RFC2217 similar)' is checked.

'Save Config' buttons are located at the bottom of the 'Basic config' and 'Select config port' sections.



Tech Support

Have technical questions? We may have answered them already!

Please visit BZBGEAR's support page (bzbgear.com/support) for helpful information and tips regarding our products. Here you will find our Knowledge Base (bzbgear.com/knowledge-base) with detailed tutorials, quick start guides, and step-by-step troubleshooting instructions. Or explore our YouTube channel, BZB TV (youtube.com/c/BZBTVchannel), for help setting up, configuring, and other helpful how-to videos about our gear.

Need more in-depth support? Connect with one of our technical specialists directly:

<u>Phone</u>	<u>Email</u>	<u>Live Chat</u>
1.888.499.9906	support@bzbgear.com	bzbgear.com

Warranty

BZBGEAR Pro AV products and cameras come with a three-year warranty. An extended two-year warranty is available for our cameras upon registration for a total of five years.

For complete warranty information, please visit bzbgear.com/warranty.

For questions, please call 1.888.499.9906 or email support@bzbgear.com.



Mission Statement

BZBGear is a breakthrough manufacturer of high-quality, innovative audiovisual equipment ranging from AVoIP, professional broadcasting, conferencing, home theater, to live streaming solutions. We pride ourselves on unparalleled customer support and services. Our team offers system design consultation, and highly reviewed technical support for all the products in our catalog. BZBGear delivers quality products designed with users in mind.

Copyright

All the contents in this manual and its copyright are owned by BZBGear. No one is allowed to imitate, copy, or translate this manual without BZBGear's permission. This manual contains no guarantee, standpoint expression or other implies in any form. Product specification and information in this manual is for reference only and subject to change without notice.

All rights reserved. No reproducing is allowed without acknowledgement.