

## Velocity 8" Touch Panel

### AT-VTP-800



The Atlona AT-VTP-800-BL and AT-VTP-800-WH are 8" touch panels in black and white, respectively, for the Atlona Velocity™ Control System. They feature contemporary, refined styling for modern presentation environments with 1280x800 native resolution, and a capacitive glass surface that supports multi-touch and gesture interactions. These touch panels conveniently install into a wall or furniture via a US two-gang opening. Also available is the optional AT-VTP-TMK tabletop mounting kit for placement on a meeting table or lectern. The VTP-800-BL and VTP-800-WH feature Power over Ethernet (PoE), enabling a single network connection for data and power. Setting up the touch panels is effortless as the AV control GUI is automatically uploaded from the Velocity Control Gateway processor during system configuration.

### Package Contents

1 x AT-VTP-800	1 x Wall installation template
1 x Metal mounting plate	1 x 2-gang mud ring
4 x Mounting screws	1 x Installation Guide

### Operating Notes

- The Velocity 8" Touch Panel (AT-VTP-800) must be on the same network as the Velocity Gateway (AT-VGW-250) or it will be unable to sync for control.
- The AT-VTP-800 is PoE capable, to power the unit, simply plug it into a 802.3at compatible network switch. If the network switch is not PoE capable, a PoE injector (purchased separately) can be used.



**IMPORTANT:** Velocity Gateway (AT-VGW-250) must be set up before the AT-VTP-800 is fully functional.



## Mounting Instructions

The AT-VTP-800 has two mounting options. In-wall or an optional stand (available through atlona.com).

### In-wall

- 1 Use the included wall mount template to create a hole in the wall the correct 2-Gang size for the unit.
- 2 Install the back box (not included) or mud ring (included) into the wall.
- 3 Screw the included metal mounting plate into the mud ring using the 4 included screws.
- 4 Remove the two screws from the bottom of the touch panel.
- 5 Run the Ethernet cable through the mud ring and metal mounting plate.
- 6 Connect the Ethernet and/or power cable into the back of the touch panel.
- 7 Line up the touch panel with the mounting plate and thread the metal hooks into the four holes on the back of the panel.
- 8 Gently press the touch panel down to ensure it is fully seated on the mounting plate.
- 9 Replace the two bottom screws to secure the touch panel to the metal mounting plate.

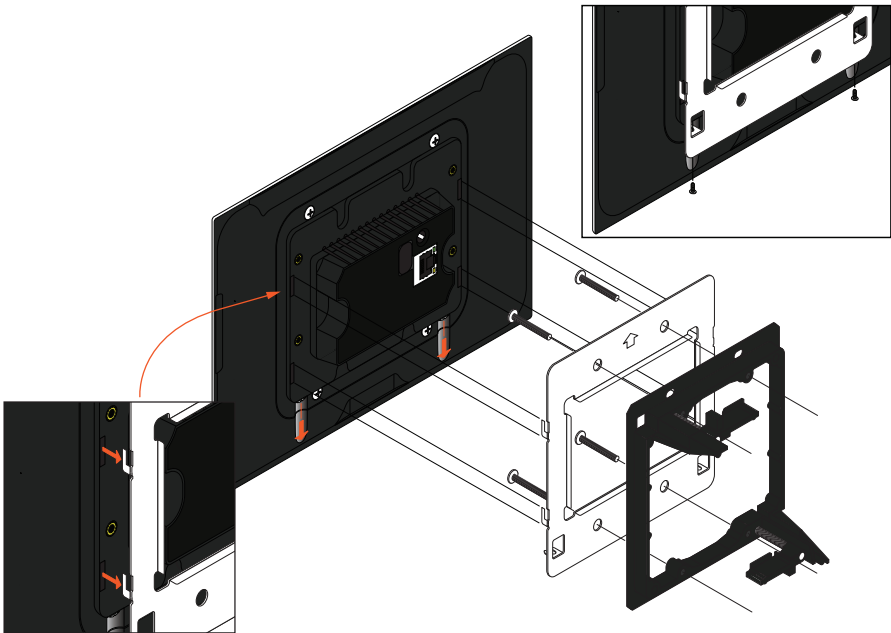



### Stand

- 1 Place the stand on the table/desk
  - a If the rubber no slip guard is not secure enough, use four wall screws and thread them through the four holes on the bottom of the unit and into the desk/table.
- 2 Thread the Ethernet cable through the bottom rounded hole on the back of the stand and back out the rectangular hole on the front of the stand.
- 3 Plug the Ethernet cable into the back of the touch panel.
- 4 Place the touch panel on the stand, pushing the excess cable back through the stand at the same time as resting the back panel of the touch panel in the rectangular front hole of the stand.
- 5 Secure the touch panel to the stand using the four stand screws (included in the stand box).
  - a Thread the screws through the 4 pre-drilled holes in the front of the stand into the four screw holes on the back of the touch panel.



**NOTE:** Tight the screws by hand. To avoid damage to the touch panel, do not overtighten.

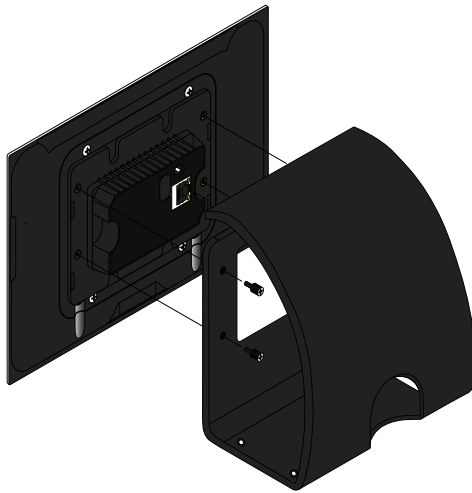

### Installation and Set Up



**NOTE:** Installation of the Velocity Touch Panel can only be done after the VGW-250 has been set up. View the AT-VGW-250 Installation Guide and Velocity Manual for instructions.

- 1 Connect the Ethernet cable into the back of the unit.
  - a If the Ethernet cable is connected to a non PoE switch, use a PoE injector using 802.3at (purchased separately).
- 2 Secure the unit in either the wall or optional stand, as explained in the mounting instructions.
- 3 The Velocity logo will display during the booting process and will go directly into setup. Press **CONTINUE** to start the setup process.



- 4 When the unit displays the IP information, press **CONTINUE**.
  - a If the touch panel does not display an IP, select the Set Static IP slider.
  - b Assign the unit a static IP. Ensure there are no other devices on the network with the same IP to avoid connection issues.



- 5 The unit will load a new screen. Change the Device Alias (if needed) to help differentiate when there are multiple touch panels at a site.
- 6 Press the **SCAN FOR GATEWAYS** button.

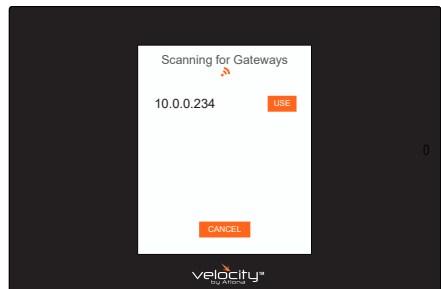
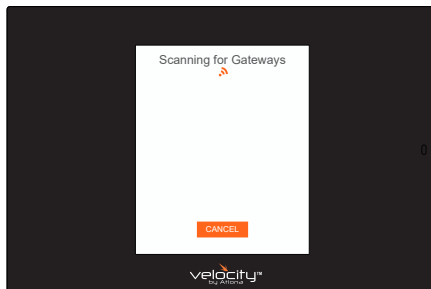

- 7 The touch panel will scan for new gateways. Once the correct gateway is found, press **USE**.

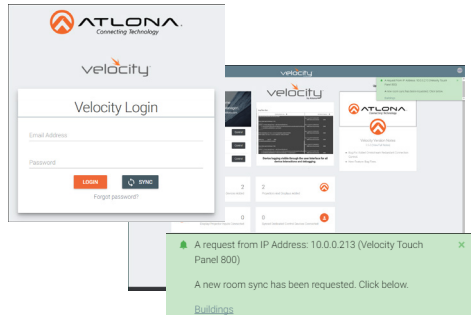

- 8 On a network computer, use a browser to log into Velocity.
- 9 A green message will appear at the top right corner of the screen. Select **Buildings**.

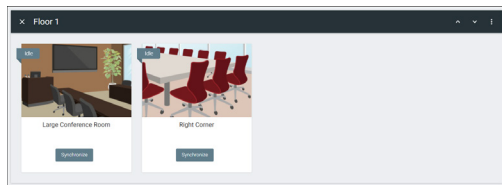
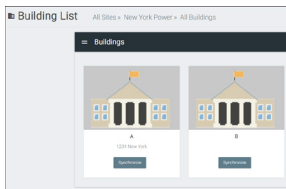

- 10 On the buildings screen, press the **Synchronize** button on the building the touch panel is located.
- 11 When the rooms page opens, press the **Synchronize** button on the touch panel's room.
- 12 Press the **SAVE & CONTINUE** button on the touch panel.

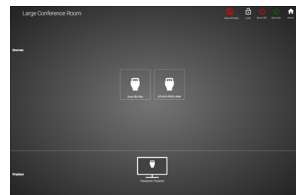
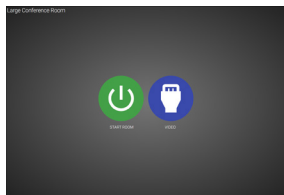

- 13 Depending on the room options there may be multiple buttons on the home page. Select the any icon to open the room's control page.

**NOTE:** The room must be completely set up to receive the control interface.

- 14 Select sources and displays by tapping on them.
  - a To route sources to displays, drag and drop the source icon onto the display box.

## Advanced Settings

Once the touch pad has been set up, the settings can be changed or reset only through the advanced settings.

- 1 To access the settings, swipe from the left side of the touch pad to the right.
- 2 Select Advanced Setup.
- 3 Type in the PIN. Default PIN is 554361.

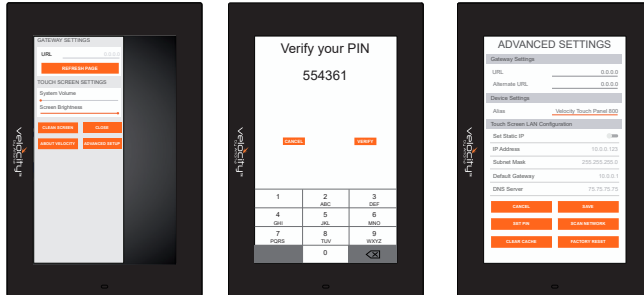

Within the advanced settings, all the touch pad settings can be changed or reset.

### Gateway Settings -

- a If the gateway IP is known, it can be typed into the **URL** field.
- b If the gateway IP is unknown, press the **Scan Network** button to search for and add the gateway.

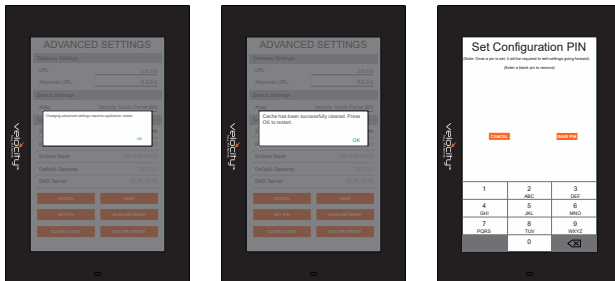

**Device Settings** - The touch pad can be renamed for easier syncing with Velocity. Type the name into the **Alias** field.

**Touch Screen LAN Configuration** - The current IP settings will display in these fields. To switch to a static IP, select the **Set Static IP** slider, fill in the IP information, and press Save.

**Set PIN** - The default PIN of 554361 can be changed to a new pin by pressing the **Set PIN** button. Type the new PIN in and press Save PIN.

**Clear Cache** - Press the **Clear Cache** button to release the current cache of the VTP. Press the **OK** button to verify.

**Factory Reset** - Press the **Factory Reset** button to clear all the settings and start the touch pad set up again. Press the **OK** button to verify.



