

ANI-42HDFIX

4x2 HDMI2.0 18Gbps Matrix Switcher w/ Scaler,
SPDIF, Analog & Web-GUI





SAFETY INFORMATION



1. To ensure the best results from this product, please read this manual and all other documentation before operating your equipment. Retain all documentation for future reference.
2. Follow all instructions printed on unit chassis for proper operation.
3. To reduce the risk of fire, do not spill water or other liquids into or on the unit, or operate the unit while standing in liquid.
4. Make sure power outlets conform to the power requirements listed on the back of the unit. Keep unit protected from rain, water and excessive moisture.
5. Do not attempt to clean the unit with chemical solvents or aerosol cleaners, as this may damage the unit. Dust with a clean dry cloth.
6. Do not use the unit if the electrical power cord is frayed or broken. The power supply cords should be routed so that they are not likely to be walked on or pinched by items placed upon or against them, paying particular attention to cords and plugs, convenience receptacles, and the point where they exit from the appliance.
7. Do not force switched or external connections in any way. They should all connect easily, without needing to be forced.
8. Always operate the unit with the AC ground wire connected to the electrical system ground. Precautions should be taken so that the means of grounding of a piece of equipment is not defeated.
9. AC voltage must be correct and the same as that printed on the rear of the unit. Damage caused by connection to improper AC voltage is not covered by any warranty.
10. Turn power off and disconnect unit from AC current before making connections.
11. Never hold a power switch in the "ON" position.
12. This unit should be installed in a cool dry place, away from sources of excessive heat, vibration, dust, moisture and cold. Do not use the unit near stoves, heat registers, radiators, or other heat producing devices.
13. Do not block fan intake or exhaust ports. Do not operate equipment on a surface or in an environment which may impede the normal flow of air around the unit, such as a bed, rug, carpet, or completely enclosed rack. If the unit is used in an extremely dusty or smoky environment, the unit should be periodically "blown free" of foreign dust and matter.
14. To reduce the risk of electric shock, do not remove the cover. There are no user serviceable parts inside. Refer all servicing to qualified service personnel. There are no user serviceable parts inside.
15. When moving the unit, disconnect input ports first, then remove the power cable; finally, disconnect the interconnecting cables to other devices.
16. Do not drive the inputs with a signal level greater than that required to drive equipment to full output.
17. The equipment power cord should be unplugged from the outlet when left unused for a long period of time.
18. Save the carton and packing material even if the equipment has arrived in good condition. Should you ever need to ship the unit, use only the original factory packing.
19. Service Information Equipment should be serviced by qualified service personnel when:
 - A. The power supply cord or the plug has been damaged.
 - B. Objects have fallen, or liquid has been spilled into the equipment.
 - C. The equipment has been exposed to rain.
 - D. The equipment does not appear to operate normally, or exhibits a marked change in performance.
 - E. The equipment has been dropped, or the enclosure damaged.

▶ CONTENTS

CONTENTS.....1
 FEATURES.....2
 SPECIFICATIONS.....3
 FRONT & BACK PANELS.....4
 CONNECTING TO THE MATRIX.....5
 REMOTE CONTROL6
 WEB GUI.....8
 ASCII CONTROL COMMAND.....14
 APPLICATION EXAMPLE19

DEAR CUSTOMER

Thank you for purchasing this product. For optimum performance and safety, please read these instructions carefully before connecting, operating or adjusting this product. Please keep this manual for future reference.

INTRODUCTION

This product is an 18G HDMI video switcher with (4) HDMI inputs and (2) scaling HDMI outputs. Each input and output supports up to 4K60 444 HDMI 18G video. The outputs can be individually scaled for 1080p or HDBaseT™ compatibility. De-embedded audio as analogue L+R and optical TosLink is available for both outputs. The Matrix Switcher can automatically control the display device using RS-232, CEC or IR when the last input signal is lost, or when the first video input is detected. This switcher can be controlled from the front panel, RS-232, IR, or LAN. This product has a 3 year warranty.

PACKAGE CONTENTS

Before attempting to use this unit, please check the packaging and make sure the following items are contained in the shipping carton:

- ANI-42HDFIX 4x2 HDMI 2.0 18Gbps Matrix Switcher
- 12V/1A Locking Power Adapter
- IR Remote
- (2) Mounting Ears
- IR Blaster Cables (4.9ft / 1.5M)
- 20~60KHz IR Receiver Cable (4.9ft / 1.5M)
- (5) 3-pin Phoenix Connectors
- Users Guide

SAFETY PRECAUTIONS

Please read all instructions before attempting to unpack, install or operate this equipment and before connecting the power supply. Please keep the following in mind as you unpack and install this equipment:

- Always follow basic safety precautions to reduce the risk of fire, electrical shock and injury to persons.
- To prevent fire or shock hazard, do not expose the unit to rain, moisture or install this product near water.
- Never spill liquid of any kind on or into this product.
- Never push an object of any kind into this product through any openings or empty slots in the unit, as you may damage parts inside the unit.
- Do not attach the power supply cabling to building surfaces.
- Use only the supplied power supply unit (PSU). Do not use the PSU if it is damaged.
- Do not allow anything to rest on the power cabling or allow any weight to be placed upon it or any person walk on it.
- To protect the unit from overheating, do not block any vents or openings in the unit housing that provide ventilation and allow for sufficient space for air to circulate around the unit.

DISCLAIMERS

The information in this manual has been carefully checked and is believed to be accurate. We assume no responsibility for any infringements of patents or other rights of third parties which may result from its use.

We assume no responsibility for any inaccuracies that may be contained in this document. We make no commitment to update or to keep current the information contained in this document.

We reserve the right to make improvements to this document and/or product at any time and without notice.

COPYRIGHT NOTICE

No part of this document may be reproduced, transmitted, transcribed, stored in a retrieval system, or any of its part translated into any language or computer file, in any form or by any means — electronic, mechanical, magnetic, optical, chemical, manual, or otherwise — without the express written permission and consent.

© Copyright 2021. All Rights Reserved.
 Version 1.2 DEC 2021

TRADEMARK ACKNOWLEDGMENTS

All products or service names mentioned in this document may be trademarks of the companies with which they are associated.

FEATURES

- HDMI 2.0, HDCP 2.2 / HDCP 1.4 and DVI 1.0 compliant
- (4) 18G HDMI 2.0 video inputs supporting up to 4K60 444 resolution
- (2) 18G HDMI 2.0 video outputs supporting up to 4K60 444 resolution
- Both outputs can be individually scaled for 4K→1080p or HDBaseT™ mode
- Automatic RS-232, CEC and IR control of the display device power state
- (2) sets of de-embedded audio analogue and TosLink outputs, for both outputs
- ARC decoding to the TosLink audio outputs only
- Test Pattern mode for testing output signal integrity to the display
- Built-in Web GUI for LAN control
- (4) methods of control: Front panel, RS-232, IR and LAN

Resolution / Cable Length	4K60 - Feet / Meters	4K30 - Feet / Meters	1080P60 - Feet / Meters
HDMI IN / OUT	16ft / 5M	32ft / 10M	50ft / 15M
The use of "Premium High Speed HDMI" cable is highly recommended.			

SPECIFICATIONS

- **Input Ports:** (4) HDMI Type A [19-pin female]
- **Output Ports:**
 - (2) HDMI Type A [19-pin female]
 - (2) L/R audio out [3-pin phoenix connector]
 - (2) OPTICAL audio out [S/PDIF]
 - (2) RS-232 A/B [3-pin phoenix connector]
- **Control Port:**
 - LAN [RJ45]
 - (3) RS-232 [3-pin phoenix connector]
 - IR IN [3.5mm Stereo Mini-jack]
 - (2) IR OUT A/B [3.5mm Stereo Mini-jack]
- **HDMI Compliance:** HDMI 2.0
- **HDCP Compliance:** HDCP 2.2 and HDCP 1.4
- **Video Bandwidth:** 18Gbps
- **Video Resolutions:**
 - 4K2K 50/60Hz 4:4:4
 - 4K2K 50/60Hz 4:2:0
 - 4K2K 30Hz 4:4:4
 - 1080p, 1080i, 720p, 720i, 480p, 480i
 - All HDMI 3D TV formats
 - All PC resolutions including 1920 x 1200
- **3D Support:** Yes
- **Output Scaling:**
 - 4K to 1080p
 - 4K to HDBaseT™ (Down-scale to no more than 10.2Gbps)
- **Color Space:** RGB, YCbCr 4:4:4, YCbCr 4:2:2, YCbCr 4:2:0
- **Color Depth:** 8-bit, 10-bit, 12-bit [1080P, 4K30Hz, 4K60Hz (YCbCr 4:2:0)] 8-bit [4K60Hz (YCbCr4:4:4)]
- **HDMI Audio Formats:** PCM2.0/5.1/7.1CH, Dolby Digital/Plus/EX, Dolby True HD, DTS, DTS-EX, DTS-96/24, DTS High Res, DTS-HD Master Audio, DSD
- **HDR Formats:** HDR10, HDR10+, Dolby Vision, HLG
- **L/R Audio Formats:** PCM2.0CH (**Note:** If ARC function is turned on, the audio port will mute.)
- **Optical Audio Formats:** PCM2.0, Dolby Digital / Plus, DTS
- **Audio Frequency:** Response 20Hz to 20kHz, ±3dB
- **RS-232 Control:** 57600, No parity, 8 data bits, 1 stop bit, No handshaking
- **RS-232-A and RS-232-B:** Configurable from 4800 to 115200 baud; 7 or 8 bits; none, odd or even parity and 1 or 2 stop bits.
- **ESD Protection Human Body Model:**
 - ± 8KV (air-gap discharge)
 - ± 4KV (contact discharge)
- **Power Supply: Input:** AC100~240V 50/60Hz / **Output:** DC12V/1A (Locking connector)
- **Dimensions (WxDxH):** 8.6 x 5.5 x 1.7 in (218x140x43mm)
- **Weight:** 2.3 lbs / 1050g
- **Housing:** Metal Enclosure
- **Color:** Black
- **Operating Temperature:** 0°C~40°C / 32°F~ 104°F
- **Storage Temperature:** -20°C~60°C / -4°F~140°F
- **Relative Humidity:** 20~90% RH (non-condensing)
- **Power Consumption:** 4.3W (max)

As product improvements are continuous, specifications are subject to change without notice.

FRONT PANEL

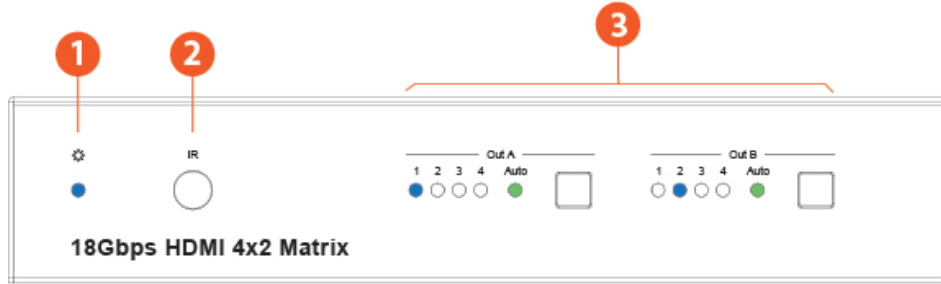

- ❶ **POWER LED:** Blue LED indicates that the unit is powered. Red LED indicates that the unit is in standby mode.
- ❷ **IR SENSOR:** IR input for remote control of the switcher.
- ❸ **OUT A / OUT B:** LED and button for each output
 - **LED 1 to LED 4:** Blue LED Indicates when the input is selected for the respective output.
 - **AUTO LED:** Green when Auto detection mode is enabled.
 - Press to select the desired input.
 - Press and hold for 3 seconds to toggle the Auto detection mode.

REAR PANEL

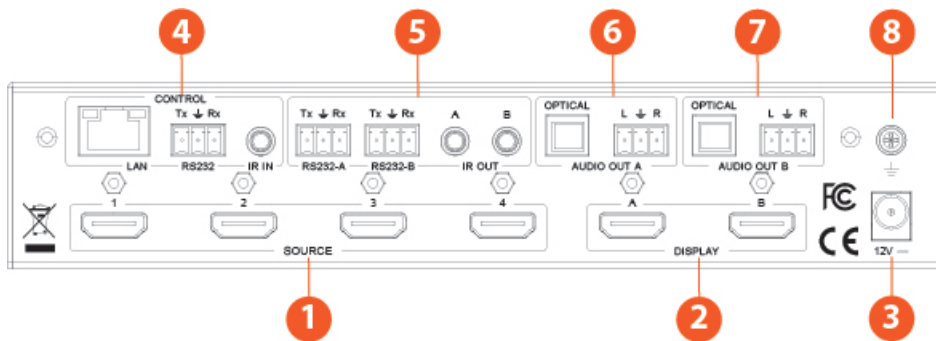

- ❶ **SOURCE:** HDMI Source inputs 1 to 4
- ❷ **DISPLAY:** HDMI outputs for displays A and B.
- ❸ **12V:** Plug DC 12V/1A power supply into the unit and connect the adapter to an AC outlet.
- ❹ **CONTROL:**
 - **LAN (RJ45):** Control port for LAN control or accessing the built-in Web GUI.
 - **RS-232:** 3-pin pluggable connector for RS-232 control of the Matrix.
 - **IR IN:** IR Eye input for IR control of the Matrix.
- ❺ **RS-232-A / RS-232-B:** 3-pin pluggable connectors for RS-232 of the display devices.
 - **IR OUT A / IR OUT B:** IR eye output for IR control of the display devices.
- ❻ **AUDIO OUT A:** TosLink connector for optical audio from HDMI Output A / 3-pin pluggable connector for stereo audio from HDMI Output A.
- ❼ **AUDIO OUT B:** TosLink connector for optical audio from HDMI Output B / 3-pin pluggable connector for stereo audio from HDMI Output B.
- ❽ **EARTHING POINT:** Screw terminal for earthing the Matrix.

CONNECTING TO THE MATRIX

1. Connect the desired HDMI input sources.
2. Connect the desired HDMI display devices.
3. Connect any CONTROL inputs that may be required: LAN, RS-232, or IR IN.
4. Connect any Display control port: RS-232-A, RS-232-B, IR OUT A or IR OUT B.
5. Connect any audio devices to either the Optical or L+R outputs.
6. Connect the 12V DC PSU.

USING THE MATRIX

Power LED and Standby Mode

The Power LED provides the following indications:

Colour	Description
Blue	The Matrix is active and fully controllable
Red	The Matrix is in standby mode, this state can be changed by using RS-232 or LAN commands, or from the Web GUI interface.

Auto LED and Button

The green AUTO LED for both outputs A and B is lit when that channel has its Auto Detection mode active. Auto Detection mode will detect any new HDMI signals and immediately switch to the input. If the currently selected input is removed then the switcher will switch to the next available input, or remain on the current input if there are no active HDMI input signals.

To change the Auto Detection mode, press and hold the button for that channel for 3 seconds until the Auto LED changes state.

Selecting Inputs

Manual Selection of the inputs is done by briefly pressing the push button repeatedly for that channel until the desired input is selected. Manual selection is always possible, irrespective of the Auto LED state. Selected inputs that have no signal will be indicated by a flashing LED.

REMOTE CONTROL

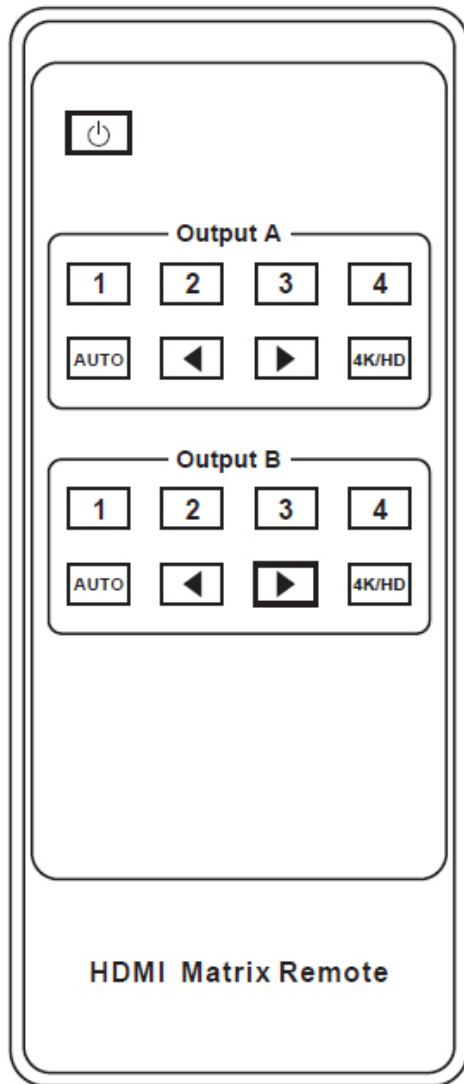

 : Power on the product or set it to standby mode.

OUTPUT A / B:

1/2/3/4: Select input source signal to Out A / B port output, corresponding Out A / B LED on the front panel illuminates in blue.

◀ ▶: Select the last or next input source signal to OUT A / B port output, corresponding Out A / B LED on the front panel illuminates in blue.

AUTO: Turn on / off AUTO function.

4K/HD: Select Out A / B 4K→1080P downscale output. *For example*, if source is 4K but TV only supports 1080P, the input resolution with 4K will downscale to 1080P to TV output.

IR CODES

USER CODE:	00FF		
POWER	00FF 14		
OUTPUT A 1	00FF 19		OUTPUT B 1
OUTPUT A 2	00FF 1B		OUTPUT B 2
OUTPUT A 3	00FF 11		OUTPUT B 3
OUTPUT A 4	00FF 15		OUTPUT B 4
OUTPUT A AUTO	00FF 17		OUTPUT B AUTO
OUTPUT A PRE	00FF 19		OUTPUT B PRE
OUTPUT A NXT	00FF 59		OUTPUT B NXT
OUTPUT A 4K	00FF 08		OUTPUT B 4K
			00FF 02

IR PIN DEFINITION



IR Receiver



IR Blaster

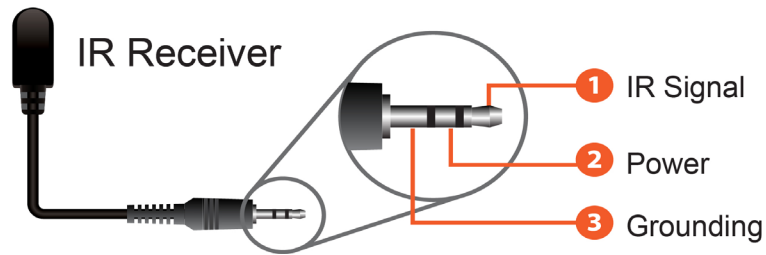
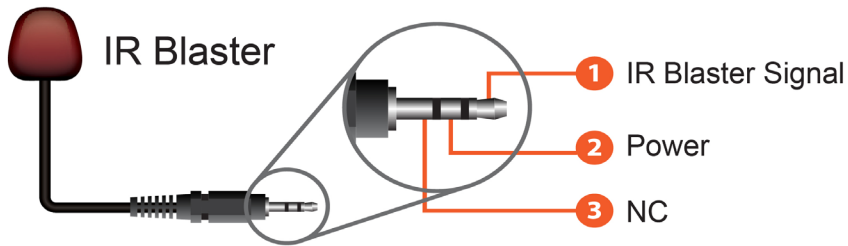

USING THE BUILT-IN WEB INTERFACE

The Matrix has a built-in web interface to provide a means of controlling or configuring various settings. There are seven pages available, each of which will be outlined in detail in the following sections.

The seven pages are:

1. **Status:** Displays information about the firmware and IP settings
2. **Switch:** Control the video routing and enabling the test pattern mode
3. **Input:** Displays information about the input signals and EDID settings
4. **Output:** Displays information about the output signals and scaler options
5. **Network:** Allows basic network setting management and login options
6. **System:** Serial baudrate, test pattern setting and firmware update
7. **Control:** Auto Power Control Settings and Commands

Note: These seven pages are only accessible in **Admin** mode, when **User** mode is used only the **Status** and **Switch** pages are available. To access the web interface, enter the IP address of the Matrix into the address bar of any web browser. If the IP address is not known, use the RS-232 commands given in the Network Settings section “**r ip addr!**” to discover the IP address of the Matrix or set the product to factory default status and IP address reset to default 192.168.1.100. After entering the IP address the following log in screen will appear:



Select the Username from the list and enter the password. The default passwords are:

Username	User	Admin
Password	user	admin

After entering the log in details, click the **LOGIN** button and the following Status page will appear.

STATUS PAGE

The Status page provides basic information about the product Model name, the installed firmware versions and the network settings. This page is visible in both User and Admin modes.



The buttons at the top right of the web interface are always available and provide the following functions:

- The Log out button will disconnect the current user from the session and display the log in screen.
- The Power On button changes the power status of the Matrix between On and Stand-by mode.

SWITCH PAGE

The Switch page allows selection of the inputs sources, set the Auto Switch mode and to enable the test pattern mode.

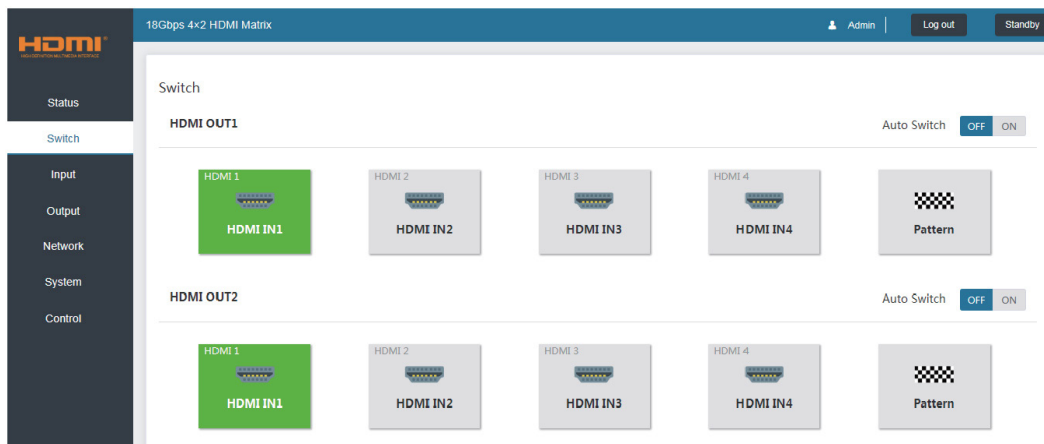

INPUT PAGE

The Input page provide information about which inputs are connected and have a signal present. The inputs can be giving more meaningful names, if desired. The EDID column provides a list of EDID options for each individual input.

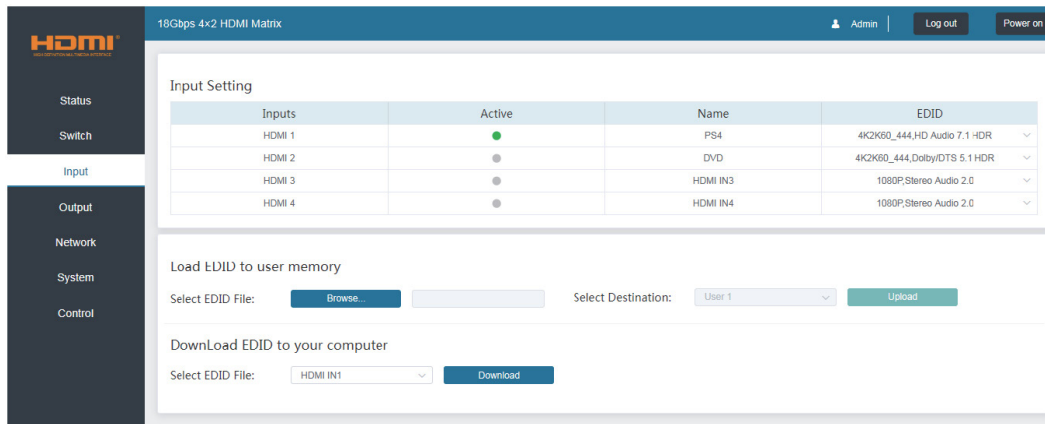

The following EDID options are available in any of the EDID drop-down lists:

- 1080P, Stereo Audio 2.0
- 1080P, Dolby/DTS 5.1
- 1080P, HD Audio 7.1
- 1080I, Stereo Audio 2.0
- 1080I, Dolby/DTS 5.1
- 1080I, HD Audio 7.1
- 3D, Stereo Audio 2.0
- 3D, Dolby/DTS 5.1
- 3D, HD Audio 7.1
- 4K2K30_444, Stereo Audio 2.0
- 4K2K 30Hz_444 Dolby/DTS 5.1
- 4K2K 30Hz_444 HD Audio 7.1
- 4K2K 60Hz_420 Stereo Audio 2.0
- 4K2K 60Hz_420 Dolby/DTS 5.1
- 4K2K 60Hz_420 HD Audio 7.1
- 4K2K 60Hz_444 Stereo Audio 2.0
- 4K2K 60Hz_444 Dolby/DTS 5.1
- 4K2K 60Hz_444 HD Audio 7.1
- 4K2K60_444,Stereo Audio 2.0 HDR
- 4K2K60_444,Dolby/DTS 5.1 HDR
- 4K2K60_444,HD Audio 2.0 HDR
- USER1
- USER2
- Copy from OUT 1
- Copy from OUT 2

Note: That the **User 1** and **User 2** are global EDID memories only. Any inputs that is set to one of these memories will always use the same EDID data from **User 1** or **User 2** respectively.

This page also provides a means of sending a binary EDID image file to either **User 1** or **User 2** EDID memories:

1. Select the binary EDID image file on your PC by click on the Browse button.
2. Select either **User 1** or **User 2** from the drop-down list.
3. Click the Upload button.

The EDID data from any input or from the **User 1** and **User 2** locations can be read and stored on your PC.

OUTPUT PAGE

The Output page provides information about the signal status of the outputs. The outputs can also be assigned meaningful names, is desired.

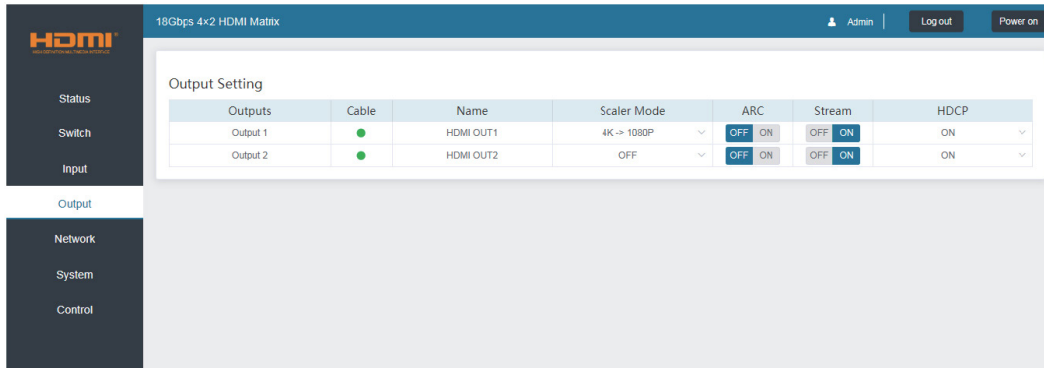

The scaler mode menu provides the following options:

- **Off:** No scaling.
- **4K→1080P:** Downscale to 1080p, if needed.
- **HDBT Mode:** Downscale to no more than 10.2Gbps for HDBaseT™ compliance.
- **Auto:** Scale to match the display requirements.

The **ARC** buttons enable or disable the ARC decoding to the analogue audio outputs.

The **Stream** buttons enable or disable the output signal for the respective output.

The **HDCP** buttons enable or disable HDCP at the respective HDMI output.

NETWORK PAGE

The Network page allows the configuration of the network settings.

Note: That the IP address boxes are only accessible when the **Mode** button is set to **Static**.

The log in passwords can be changed s on this page.

Note: That any changes to this page will require the new details into the web browser and/or the log in screen.

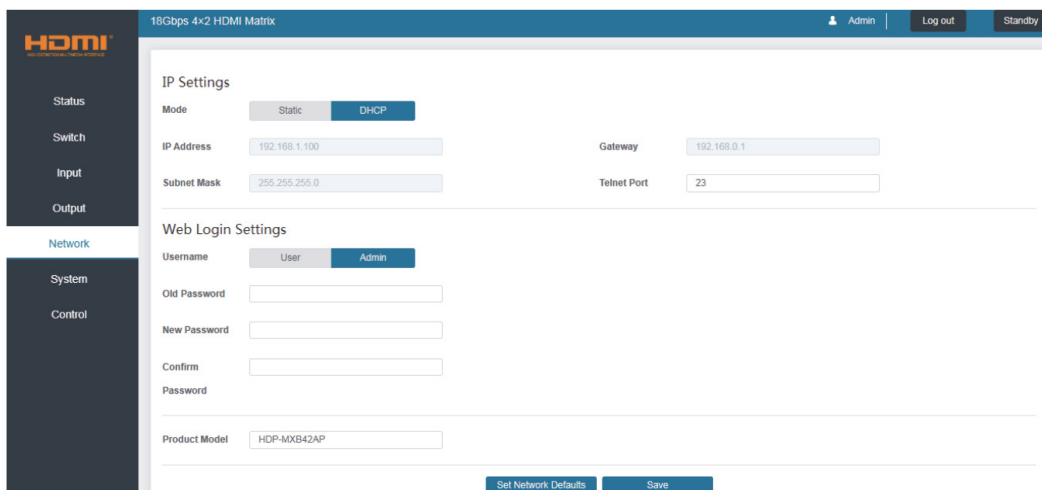

SYSTEM PAGE

The system page allows setting of the control RS-232 port baud rate and changing the test pattern output. This page is also used to install new firmware updates, restore the factory default settings and reboot the Matrix.

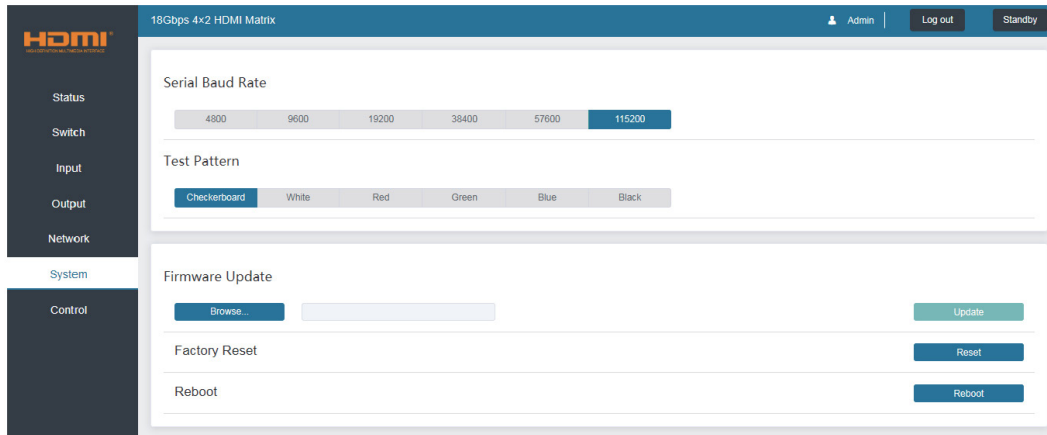

CONTROL PAGE

The Control page is used to set the RS-232 or IR display device power on/off commands for the Automatic Power Switching mode. When this mode is enabled, the display power off and power on commands will be sent from RS-232-A/RS-232-B or IR-A/IR-B outputs after the defined Power Off Timeout and Power On Timeout values respectively.

The Control page has three modes: RS-232, CEC or IR. Power On and Power Off commands can only be entered for the **RS-232** and **IR** modes. The CEC mode power on and power off commands are provided by default and cannot be changed. Only use CEC mode with displays that support CEC commands.

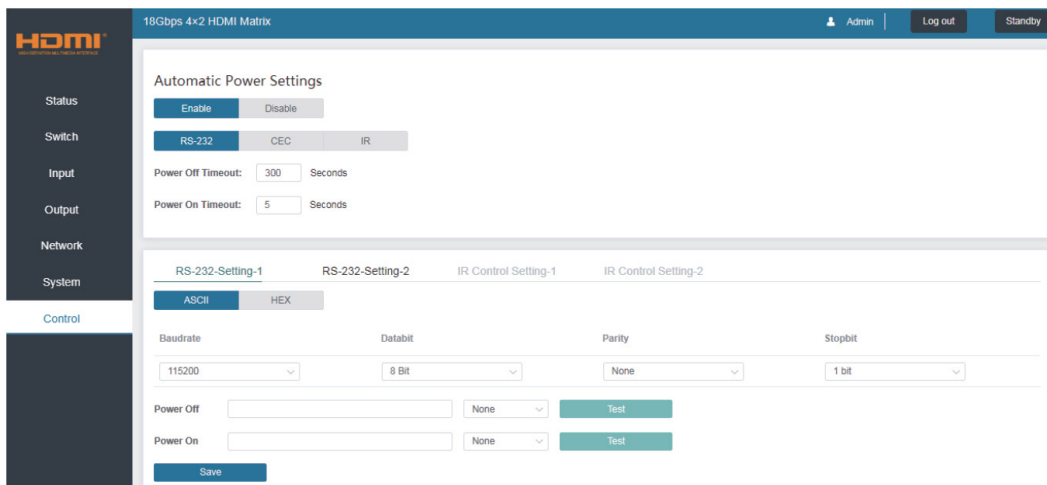

- RS-232 Setting 1 and RS-232 Setting 2

Select the desired tab and configure the RS-232 port settings to match the display device requirements. Select either ASCII or HEX for the command format and enter the Power Off and Power On commands with the appropriate command termination mode: None, CR, LR or CRLF.

If the display device is connected to the respective RS-232-A or RS-232-B port, use the Test buttons to confirm that the command is correct. Once the command is valid, use the Save button to store those commands in the Matrix.

Note: That ASCII commands can use any ASCII character, but HEX command must use hexadecimal notation using hexadecimal value pairs separated by spaces.

•RS-232 Setting 1 and RS-232 Setting 2

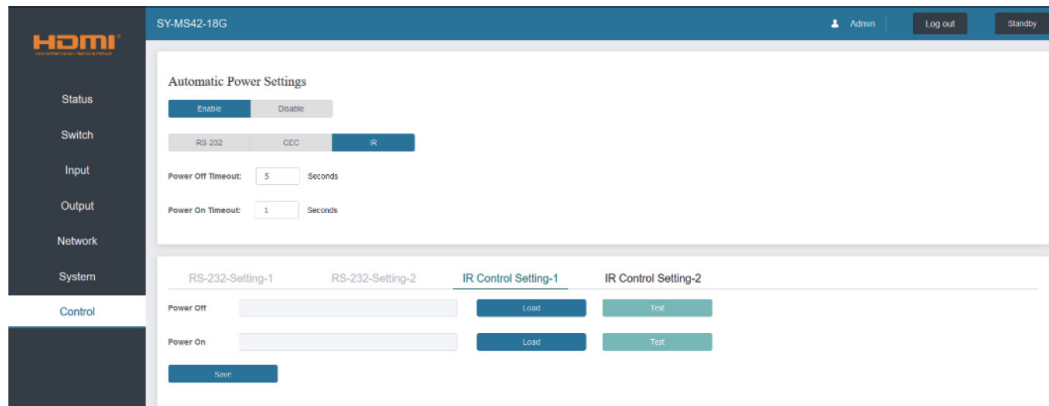

This page requires that the IR commands are available in plain text files using the CCF IR code format.

1. Select the desired IR Control Setting tab.
2. Click the Load button to load the respective IR command. If the display device only support a power toggle IR command, then use the same file for both the Power On and Power Off modes.
3. Use the Test button to confirm that the command functions.
4. Click the Save button to save both IR commands to the Matrix.

ASCII CONTROL COMMAND

The Matrix also supports ASCII control. You need to a RS-232 phoenix connector male head to RS-232 female head with DB9 serial cable and a RS-232 male head with DB9 to USB male head serial cable. The phoenix connector male head is connected the RS-232 port of the Matrix, and the USB head of the serial cable is connected a PC. Open any of a Serial Command tool on PC such as “**Docklight**” to send command to control the Matrix. Please see the following connection diagram.

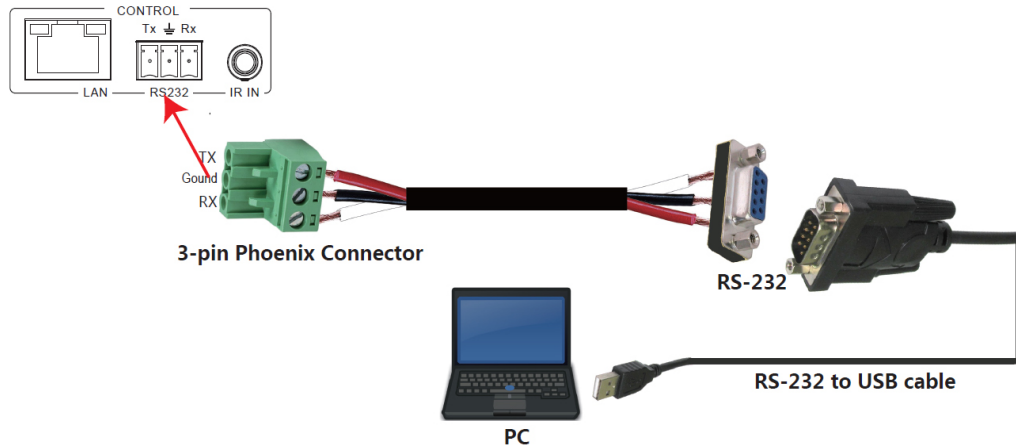

Figure 1: 3-pin phoenix connector to USB

Important:

1. All messages sent to the Matrix must be terminated with an exclamation mark (!). Any carriage return that is present after the end of the command will be ignored.
2. All spaces shown in the commands are required.
3. All response messages are terminated by a CR/LF sequence.
4. When all four inputs are requested by the same command, the response will report each input on a separate line.
5. When both outputs are requested by the same command, the response will report each output on a separate line.

The ASCII list about the product is shown as below.

ASCII COMMANDS		
Serial port protocol: Baud rate:115200 (default), Data bits: 8bit, Stop bits:1, Check bit: 0, TCP/IP protocol port: 8000. The x, y, z, XXX are parameter.		
RS-232 COMMAND	FUNCTION DESCRIPTION	FEEDBACK
r type!	Get device model	ANI-42HDFIX
r status!	Get device current status	Get the unit all status: power, in/out connection, video/audio crosspoint, edid, scaler,hdcp, network status
r fw version!	Get Firmware version	MCU BOOT: V1.00.01 MCU APP : V1.10.05
r link in x!	Get the connection status of the x input port, x=0~4 (0=all)	HDMI IN1: connect
r link out y!	Get the connection status of the y output port, y=0~2 (0=all)	HDMI OUT1: connect
s reset!	Reset to factory defaults	Reset to factory defaults System Initializing... Initialization Finished!
s power z!	power on/off the device, z=0~1 (z=0 power off, z=1 power on)	Power on System Initializing... Initialization Finished! power off
r power!	get current power state	power on /power off
s reboot!	reboot the device	Reboot... System Initializing... Initialization Finished!
OUTPUT SETTING		
s in x av out y!	Set input x to output y, x=1~4, y=0~2 (0=all)	input 1 -> output 2
r av out y!	Get output y signal status y=0~2 (0=all)	input 1 -> output 1 input 2 -> output 2
s hdmi y stream z !	Set hdmi output y stream on/off, y=0~2 (0=all) z=0~1 (0:disable, 1:enable)	Enable HDMI out1 stream Disable HDMI out1 stream
r hdmi y stream!	Get hdmi output y stream status, y=0~2 (0=all)	Enable HDMI out1 stream
s hdmi y scaler z!	Set hdmi output y port output mode, y=0~2 (0=all), z=1~4 (1=off, 2=4k->1080p, 3=hdbt mode, 4=Auto)	hdmi output 1 set to bypass mode
r hdmi y scaler !	Get hdmi output y port output mode y=0~2 (0=all)	hdmi output 1 set to bypass mode
s hdmi y hdcp z!	set hdmi output y port hdcp status y=0~2 (0=all) z=0~1 (1=on, 0=off)	hdmi out 1 hdcp on
r hdmi y hdcp!	Get HDCP status of HDMI out y, y=0~2 (0=all)	hdmi out 1 hdcp active
s hdmi y pattern z!	Set hdmi output y test pattern on/off.y=0~2 (0=all, 1=OUT 1, 2=OUT 2) z=0~1 (0=off ,1=on)	hdmi output 1 test pattern on
r hdmi y pattern!	Get hdmi output y test pattern on/off status. y=0~2 (0=all 1=OUT 1, 2=OUT 2)	hdmi output 1 test pattern on
s pattern mode z!	Set test patterns type. z=1~6 (1- Checkerboard 2-White 3-Red 4-Green 5-Blue 6-Black)	set pattern White!
r pattern mode!	Get test pattern mode.	set pattern White!

EDID SETTING		
s edid in x from z!	Set input x EDID from default EDID z, x=0~4 (0=all), z=1~25 1=1080p,Stereo Audio 2.0 2=1080p,Dolby/DTS 5.1 3=1080p,HD Audio 7.1 4=1080i,Stereo Audio 2.0 5=1080i,Dolby/DTS 5.1 6=1080i,HD Audio 7.1 7=3D,Stereo Audio 2.0 8=3D,Dolby/DTS 5.1 9=3D,HD Audio 7.1 10=4K2K30_444,Stereo Audio 2.0 11=4K2K30_444,Dolby/DTS 5.1 12=4K2K30_444,HD Audio 7.1 13=4K2K60_420,Stereo Audio 2.0 14=4K2K60_420,Dolby/DTS 5.1 15=4K2K60_420,HD Audio 7.1 16=4K2K60_444,Stereo Audio 2.0 17=4K2K60_444,Dolby/DTS 5.1 18=4K2K60_444,HD Audio 7.1 19=4K2K60_444,Stereo Audio 2.0 HDR 20=4K2K60_444,Dolby/DTS 5.1 HDR 21=4K2K60_444,HD Audio 7.1 HDR 22=User1 23=User2	IN1 EDID: 1080p,Stereo Audio 2.0
r edid in x!	Get EDID status of the input x, x=0~4 (0=all input)	IN1 EDID: 4K2K60_444, Stereo Audio 2.0 IN2 EDID: 4K2K60_444, Stereo Audio 2.0 IN3 EDID: 4K2K60_444, Stereo Audio 2.0 IN4 EDID: 4K2K60_444, Stereo Audio 2.0
r edid data hdmi y!	Get the EDID data of the hdmi output y port, y=1~2	EDID: 00 FF FF FF FF FF FF 00
AUDIO SETUP		
s hdmi y arc z!	Turn on/off arc of HDMI output y, y=0~2 (0=all) z=0~1 (z=0, off, z=1 on)	hdmi output 1 arc on hdmi output 1 arc off
r hdmi y arc!	Get the arc state of HDMI output y, y=0~2 (0=all)	hdmi out1 arc on
s spdif x mute y!	Enable/disable the audio outputs . x=1~2 (1=spdif 1, 2=spdif 2), y=0~1 (0=unmute, 1=mute)	spdif 1 mute
r spdif x mute!	Read the audio output state. x=1~2 (1=spdif 1, 2=spdif 2)	spdif 1 mute
NETWORK SETTING		
r ipconfig!	Get the Current IP Configuration	IP Mode: Static IP: 192.168.1.72 Subnet Mask: 255.255.255.0 Gateway: 192.168.1.1 TCP/IP port: 23 Mac address: 00:1C:91:03:80:01
r mac addr!	Get network MAC address	Mac address: 00:1C:91:03:80:01
s ip mode z!	Set network IP mode to static IP or DHCP, z=0~1 (z=0 Static, z=1 DHCP)	Set IP mode: Static. Please use "s net reboot!" command or repower device to apply new config!

r ip mode!	Get network IP mode	IP mode: Static
s ip addr xxx.xxx.xxx.xxx!	Set network IP address	Set IP address:192.168.1.100. Please use "s netreboot!" command or repower device to apply new config! DHCP on, Device can't config static address, set DHCP off first.
r ip addr!	Get network IP address	IP address:192.168.1.100
s subnet xxx.xxx.xxx.xxx!	Set network subnet mask	Set subnet Mask:255.255.255.0. Please use "s net reboot!" command or repower device to apply new config! DHCP on, Device can't config subnet mask, set DHCP off first.
r subnet!	Get network subnet mask	Subnet Mask:255.255.255.0
s gateway xxx.xxx.xxx.xxx!	Set network gateway	Set gateway:192.168.1.1 Please use "s net reboot!" command or repower device to apply new config! DHCP on, Device can't config gateway, set DHCP off first.
r gateway!	Get network gateway	Gateway:192.168.1.1
s tcp/ip port x!	Set network TCP/IP port (x=1~65535)	Set tcp/ip port: 8000
r tcp/ip port!	Get network TCP/IP port	tcp/ip port: 8000
s telnet port x!	Set network telnet port (x=1~65535)	Set telnet port: 23
r telnet port!	Get network telnet port	telnet port: 23
s net reboot!	Reboot network modules	Network reboot... IP Mode: Static IP: 192.168.1.72 Subnet Mask: 255.255.255.0 Gateway: 192.168.1.1 Mac address: 00:1C:91:03:80:01
CONTROL SETTING		
s autopower z!	Set display auto power on/off control z=0~1 (z=0 disable, z=1 enable)	Display autopower control enable
r autopower!	Get display auto power state	Display autopower control enable
s autopower mode z!	Set display auto power control mode z=1~3 (z=1 RS-232, z=2 CEC, z=3 IR)	Display autopower control by RS-232
r autopower mode!	Get display auto power mode	Display autopower control by RS-232
s autopower on time y!	Set auto power on timeout y=0~600 seconds	Display autopower on timeout is 100 seconds
r autopower on time!	Get auto power on timeout	Display autopower on timeout is 100 seconds
s autopower off time y!	Set auto power off timeout y=0~600 seconds	Display autopower off timeout is 100 seconds
r autopower off time!	Get auto power off timeout	Display autopower off timeout is 100 seconds
s cec cmd (PORT) (SOURCE+DESTINATION) (OPCODE)(ARGS) end!	CEC command sending. (PORT) is 1 byte; [PORT] = 01~02 is hdmi output 1~2; (SOURCE+DESTINATION) is 1 byte, 4~7bit is [SOURCE], 0~3bit is [DESTINATION] [SOURCE] is command Initiator LogicAddress, [DESTINATION] is command Follower LogicAddress. [OPCODE] is Operating code for CEC, [ARGS] is the parameters for the CEC opcode, Some of the CEC commands have parameters and some have no parameters, so [ARGS] is Optional end! Is the terminator	PORT: HDMI OUT 1 SOURCE: 05 DESTINATION: 0F OPCODE: 82 ARGS: 10 00

<p>s rs232 (port) (format)(baudrate) (databit)(parity) (stopbit)(cmdterminating) [cmddata]!</p>	<p>port=(01=RS232-A, 02=RS232-B) format=(00=ASCII, 01=HEX) baudrate=(00-4800 01-9600 02-19200 03-38400 04-57600 05-115200) databit=(00-7bit 01-8bit) parity=(00-none 01-odd 02-even) stopbit=(00-1bit 01-2bit) cmdterminating=(00-none 01-cr 02-lf 03-cr+lf) cmddata=cmd data</p>	<p>Port: RS232-A Format: ASCII Baudrate: 115200 Databit: 8bit Parity: none Stopbit: 1bit Terminator: none Data: r ipconfig!</p>
---	---	---

Note: That you can send '**RS232 command**' to control the Matrix via Serial Command tool. The '**Function description**' explains function about the command. The "Feedback" displays whether the command sends success or not and feedback the information you need to.

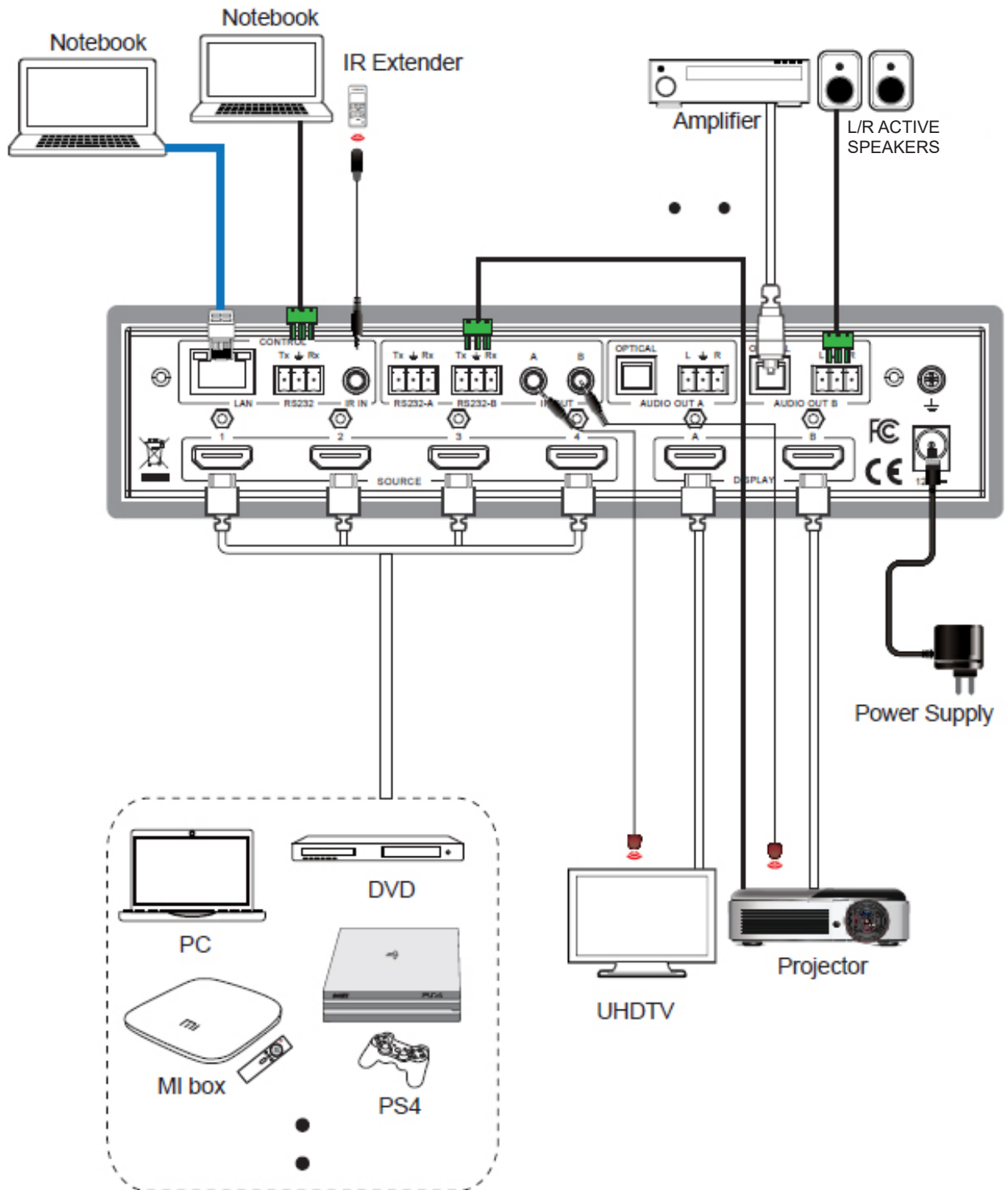

THIS PAGE IS INTENTIONALLY LEFT BLANK.

THIS PAGE IS INTENTIONALLY LEFT BLANK.

PLEASE READ THE FOLLOWING TERMS AND CONDITIONS CAREFULLY BEFORE USING THIS HARDWARE, COMPONENTS AND SOFTWARE PROVIDED BY, THROUGH OR UNDER A-NeuVideo, INC (COLLECTIVELY, THE "PRODUCT"). By using installing or using the Product, you unconditionally signify your agreement to these Terms and Conditions. If you do not agree to these Terms and Conditions, do not use the Product and return the Product to A-NeuVideo, Inc. at the return address set forth on the Product's packing label at your expense. A-NeuVideo, Inc. may modify these Terms and Conditions at anytime, without notice to you.

RESTRICTIONS ON USE OF THE PRODUCT

It is your responsibility to read and understand the installation and operation instructions, both verbal and in writing, provided to you with respect to the Product. You are authorized to use the Product solely in connection with such instructions. Any use of the Product not in accordance with such instructions shall void any warranty pertaining to the Product. Any and all damages that may occur in the use of the Product that is not strictly in accordance with such instructions shall be borne by you and you agree to indemnify and hold harmless A-NeuVideo, Inc. from and against any such damage.

The Product is protected by certain intellectual property rights owned by or licensed to A-NeuVideo. Any intellectual property rights pertaining to the Product are licensed to you by A-NeuVideo, Inc. and/or its affiliates, including any manufacturers or distributors of the Product (collectively, "A-NeuVideo") for your personal use only, provided that you do not change or delete any proprietary notices that may be provided with respect to the Product.

The Product is sold to you and any use of any associated intellectual property is deemed to be licensed to you by A-NeuVideo for your personal use only. A-NeuVideo does not transfer either the title or the intellectual property rights to the Product and A-NeuVideo retains full and complete title to the intellectual property rights therein. All trademarks and logos are owned by A-NeuVideo or its licensors and providers of the Product, and you may not copy or use them in any manner without the prior written consent of A-NeuVideo, which consent may be withheld at the sole discretion of A-NeuVideo.

The functionality and usability of the Product is controlled by A-NeuVideo, Inc. from its offices within the State of Texas, United States of America. A-NeuVideo makes no representation that materials pertaining to the Product are appropriate or available for use in other locations other than the shipping address you provided with respect thereto. You are advised that the Product may be subject to U.S. export controls.

DISCLAIMERS AND LIMITATION OF LIABILITY

A-NeuVideo may change or modify the Product at any time, from time to time.

THE PRODUCT IS PROVIDED "AS IS" AND WITHOUT WARRANTIES OF ANY KIND EITHER EXPRESS OR IMPLIED. A-NEUVIDEO DOES NOT WARRANT OR MAKE ANY REPRESENTATIONS REGARDING THE USE OR THE RESULTS OF THE USE OF THE PRODUCT'S CORRECTNESS, ACCURACY, RELIABILITY, OR OTHERWISE.

A-NeuVideo has no duty or policy to update any information or statements pertaining to the Product and, therefore, such information or statements should not be relied upon as being current as of the date you use the Product. Moreover, any portion of the materials pertaining to the Product may include technical inaccuracies or typographical errors. Changes may be made from time to time without notice with respect to the Product.

TO THE FULLEST EXTENT PERMISSIBLE PURSUANT TO APPLICABLE LAW, A-NEUVIDEO DISCLAIMS ALL WARRANTIES, EXPRESS OR IMPLIED, INCLUDING, BUT NOT LIMITED TO IMPLIED WARRANTIES OF MERCHANTABILITY, FITNESS FOR A PARTICULAR PURPOSE AND NON-INFRINGEMENT. A-NEUVIDEO DOES NOT WARRANT THE ACCURACY, COMPLETENESS OR USEFULNESS OF ANY INFORMATION WITH RESPECT TO THE PRODUCT. A-NEUVIDEO DOES NOT WARRANT THAT THE FUNCTIONS PERTAINING TO THE PRODUCT WILL BE ERROR-FREE, THAT DEFECTS WITH RESPECT TO THE PRODUCT WILL BE CORRECTED, OR THAT THE MATERIALS PERTAINING THERETO ARE FREE OF DEFECTS OR OTHER HARMFUL COMPONENTS. A-NEUVIDEO WILL USE ITS REASONABLE EFFORTS TO CORRECT ANY DEFECTS IN THE PRODUCT UPON TIMELY WRITTEN NOTICE FROM YOU NOT TO EXCEED 10 BUSINESS DAYS AFTER RECEIPT BY YOU OF THE PRODUCT, BUT YOU (AND NOT A-NEUVIDEO) ASSUME THE ENTIRE COST OF ALL NECESSARY SERVICING, REPAIR AND CORRECTION THAT WAS CAUSED BY YOU UNLESS OTHERWISE AGREED TO IN A SEPARATE WRITING BY A-NEUVIDEO.

UNDER NO CIRCUMSTANCES, INCLUDING, BUT NOT LIMITED TO, NEGLIGENCE, SHALL A-NEUVIDEO BE LIABLE FOR ANY SPECIAL OR CONSEQUENTIAL DAMAGES THAT RESULT FROM THE USE OF, OR THE INABILITY TO USE THE PRODUCT IN ACCORDANCE WITH ITS SPECIFICATIONS, EVEN IF A-NEUVIDEO OR ITS REPRESENTATIVES HAVE BEEN ADVISED OF THE POSSIBILITY OF SUCH DAMAGES. IN NO EVENT SHALL A-NEUVIDEO'S TOTAL LIABILITY TO YOU FROM ALL DAMAGES, LOSSES, AND CAUSES OF ACTION (WHETHER IN CONTRACT, OR OTHERWISE) EXCEED THE AMOUNT YOU PAID TO A-NEUVIDEO, IF ANY, FOR THE PRODUCT.