

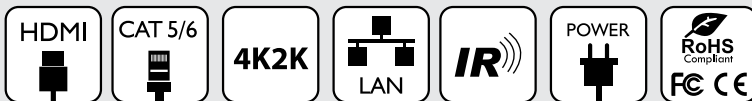

AV Connectivity, Distribution And Beyond...

**VIDEO WALLS VIDEO PROCESSORS
VIDEO MATRIX SWITCHES
EXTENDERS SPLITTERS WIRELESS
CABLES & ACCESSORIES**

HDBaseT Lite HDMI CAT5/6/7 Extender with POE/RS-232/ Bi-directional IR



Model #: HBT-C6PLT-R

© 2013 Avenview Inc. All rights reserved.

The contents of this document are provided in connection with Avenview Inc. ("Avenview") products. Avenview makes no representations or warranties with respect to the accuracy or completeness of the contents of this publication and reserves the right to make changes to specifications and product descriptions at any time without notice. No license, whether express, implied, or otherwise, to any intellectual property rights is granted by this publication. Except as set forth in Avenview Standard Terms and Conditions of Sale, Avenview assumes no liability whatsoever, and claims any express or implied warranty, relating to its products are strictly prohibited.

Product Application & Market Sectors



Corporate



House Of Worship



Military



Residential



Education



Industrial



Medical



Aviation



TABLE OF CONTENTS

1.	GETTING STARTED	1
1.1	IMPORTANT SAFEGUARDS	1
1.2	SAFETY INSTRUCTIONS	1
1.3	REGULATORY NOTICES FEDERAL COMMUNICATIONS COMMISSION (FCC)	2
2.	INTRODUCTION	3
2.1	PACKAGE CONTENTS	4
2.2	BEFORE INSTALLATION	5
2.3	CABLE SPECIFICATIONS	5
3.	APPLICATION DIAGRAM.....	6
4.	PANEL DESCRIPTION	7
	INPUT PANEL (Receiver, HBT-C6POE-R) Front.....	7
5.	IR CABLE DEFINITIO.....	8
6.	INSTALLATION (HBT-C6POE-R).....	9
7.	GENERAL TROUBLESHOOTING.....	10
8.	SPECIFICATIONS	11



SECTION I: GETTING STARTED

I.1 IMPORTANT SAFEGUARDS

Please read all of these instructions carefully before you use the device. Save this manual for future reference.

What the warranty does not cover

- Any product, on which the serial number has been defaced, modified or removed.
- Damage, deterioration or malfunction resulting from:
 - Accident, misuse, neglect, fire, water, lightning, or other acts of nature, unauthorized product modification, or failure to follow instructions supplied with the product.
 - Repair or attempted repair by anyone not authorized by us.
 - Any damage of the product due to shipment.
 - Removal or installation of the product.
 - Causes external to the product, such as electric power fluctuation or failure.
 - Use of supplies or parts not meeting our specifications.
 - Normal wear and tear.
 - Any other causes which does not relate to a product defect.
- Removal, installation, and set-up service charges.

I.2 SAFETY INSTRUCTIONS

The HBT-C6PLT-R HDBaseT Lite HDMI CAT5/6/7 Receiver has been tested for conformance to safety regulations and requirements, and has been certified for international use. However, like all electronic equipments, the HBT-C6PLT-R should be used with care. Read the following safety instructions to protect yourself from possible injury and to minimize the risk of damage to the unit.



- ⚠ Do not dismantle the housing or modify the module.
- ⚠ Dismantling the housing or modifying the module may result in electrical shock or burn.
- ⚠ Refer all servicing to qualified service personnel.
- ⚠ Do not attempt to service this product yourself as opening or removing housing may expose you to dangerous voltage or other hazards
- ⚠ Keep the module away from liquids.
- ⚠ Spillage into the housing may result in fire, electrical shock, or equipment damage. If an object or liquid falls or spills on to the housing, unplug the module immediately.
- ⚠ Have the module checked by a qualified service engineer before using it again.
- ⚠ Do not use liquid or aerosol cleaners to clean this unit. Always unplug the power to the device before cleaning.



1.3 REGULATORY NOTICES FEDERAL COMMUNICATIONS COMMISSION (FCC)

This equipment has been tested and found to comply with Part 15 of the FCC rules. These limits are designed to provide reasonable protection against harmful interference in a residential installation.

Any changes or modifications made to this equipment may void the user's authority to operate this equipment.

Warning symbols	Description
	<p>ONLY USE THE PROVIDED POWER CABLE OR POWER ADAPTER SUPPLIED. DO NOT TAMPER WITH THE ELECTRICAL PARTS. THIS MAY RESULT IN ELECTRICAL SHOCK OR BURN.</p>
	<p>DO NOT TAMPER WITH THE UNIT. DOING SO WILL VOID THE WARRANTY AND CONTINUED USE OF THE PRODUCT.</p>
	<p>THE VIDEO BOARDS ARE VERY SENSITIVE TO STATIC. PLEASE ENSURE IF RACK MOUNTED OR INSTALLED ON A SURFACE, IT SHOULD BE IN A GROUNDED ENVIROMENT.</p>

	<p>⚠ WARNING</p>
	<p>Read & understand user guide before using this device.</p> <p>Failure to follow the proper installation instructions could result in damage to the product and preventing expected results.</p>

2. INTRODUCTION

The Avenview HBT-C6PLT-R HDBaseT Lite Receiver CAT5/6/7 with POE, Bi-Directional IR and Ethernet has been designed to extend High Definition video and multi-channel digital audio formats to any HD Monitor.

Video Signals: 4K2K@30 (Ultra HD), 3D, Deep Color, and Full HD 1080p 36-bit color depth.

Audio signals: Lossless Multi-channel audio formats (DTS-HD Master Audio, Dolby TrueHD).

Data Signals: Bi-Directional IR signals 30 KHz to 50 KHz over CAT5/6.

The HBT-C6PLT-R includes one (1) unit: Receiving unit (Rx) HBT-C6PLT-R with one (1) UTP output port which allows the user to extend video and audio up to 60m (200ft). The HBT-C6PLT-R also allows bi-directional IR control of the source connected to the unit from the users IR remote control at the monitor side.

The bonus features with this device it can support PoE (Power over the CATx cable to the RX).

- INPUT: HDMI with 3D & 4Kx2K, 1080p, HDCP and DVI compliant
- VIDEO BANDWIDTH: From 300MHz / 9 Gbps
- PC RESOLUTIONS: Up to VGA to WUXGA
- HD RESOLUTIONS: Up to 4Kx2K (3840x2160@30Hz and 4096x2160@24Hz) 1080p (1920x1080@60Hz)
- AUDIO SUPPORTED: LPCM 7.1CH, Dolby TrueHD, Dolby Digital Plus and DTS-HD Master Audio
- AUDIO TRANSMISSION: (32-192kHz sample rate)
- SUPPORTS: CEC bypass
- DISTANCE: Up to 60 meters through CAT6e/6a/7 cables
- UNCOMPRESSED VIDEO: 1080p, 60 Hz, 36-bit
- 3D SUPPORT: Follow by Display / TV's EDID

NOTE:

- The PoE function is designed for powering compatible Receiver units only.
- The non-PoE Receivers has to be powered with a power supply.
- Receivers (Rx) from different manufactures would not be compatible.
- Displaying HDMI 4Kx2K resolution would require the standard 4Kx2K HDMI cable and display for accurate results.



2.1 PACKAGE CONTENTS

I	HBT-C6PLT-R	
	IR EXTENDER	
	IR BLASTER	
	USER'S MANUAL	











2.2 BEFORE INSTALLATION

- Put the product in an even and stable location. If the product falls down or drops, it may cause an injury or malfunction.
- Don't place the product in too high temperature (over 50°C), too low temperature (under 0°C) or high humidity.
- Use the DC power adapter with correct specifications and supplied with the unit. If improper power supply is used the unit may malfunction and cause a fire.
- Do not twist or pull by force ends of the UTP cable. It can cause malfunction.

2.3 CABLE SPECIFICATIONS

Cable Type	Range	Pixel clock rate	Video Data Rate	Supported Video
CAT5e/6	100m	<=225MHz	<=5.3Gbps (HD Video)	Up to 1080p, 60Hz, 36 bits, 3D (Data rates lower than 5.3 Gbps or below 225 Mhz TMDs clock).
	70m	>225MHz	>5.3Gbps (Ultra HD Video)	4K2K, 30Hz video formats
CAT6A/7	100m	>225MHz	>5.3Gbps (Ultra HD Video)	4K2K, 30Hz video formats

Data Link TIA/EIA-568-B		
PIN	Color	Function
1	 W-O	TX0-
2	 O	TX0+
3	 W-G	TX1-
4	 BL	TX2-
5	 W-BL	TX2+
6	 G	TX1+
7	 W-BR	TXC-
8	 BR	TXC+

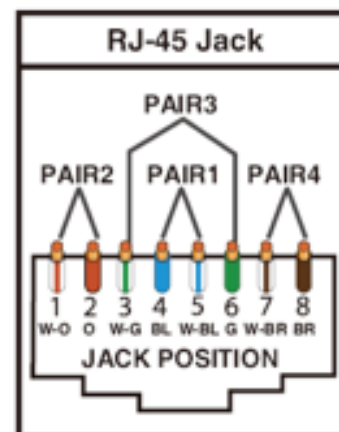

3. APPLICATION DIAGRAM

HBT-C6POE-SP4

4K2K (3840X2160) = 75m (165 feet) CAT6E 250MHz
 4K2K (3840X2160) = 100m (330 feet) CAT6A 500-625MHz
 1080p(1920x1080) = 100m (330 feet) CAT6E 250MHz
 1080p(1920x1080) = 110m (360 feet) CAT6A 500-625MHz

LAYOUT 1

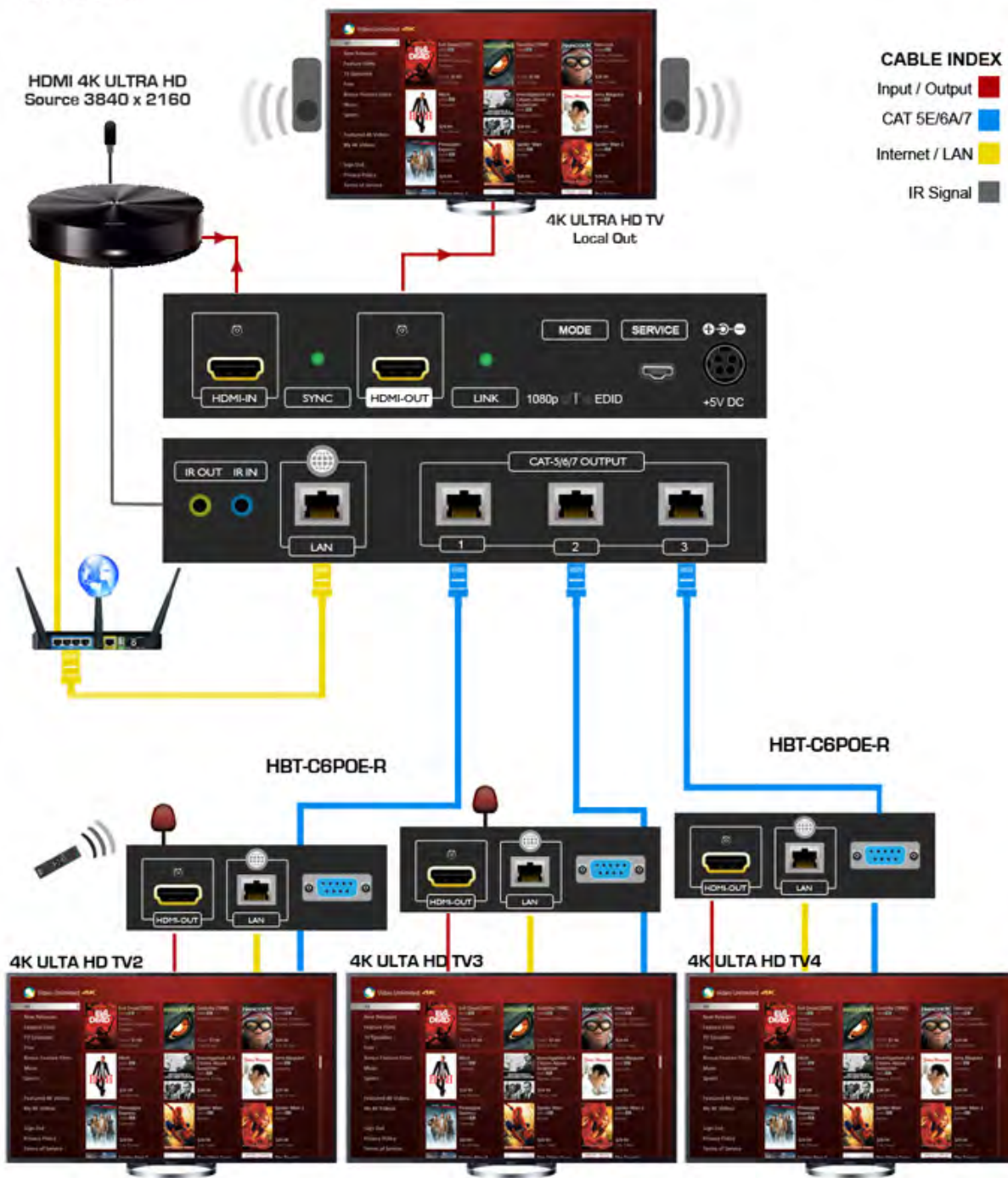

4. PANEL DESCRIPTION

INPUT PANEL (Receiver, HBT-C6PLT-R) Front

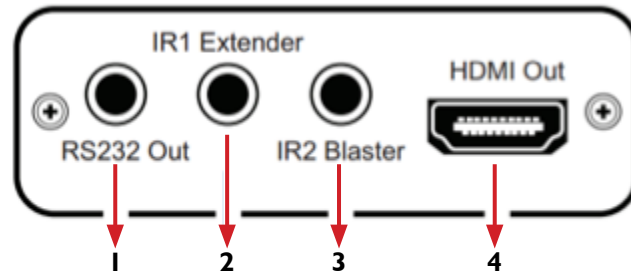

<p>1. HDMI OUT: Connect to HDMI display Max 35ft via HDMI Cable or cascade with another Avenview type Transmitter</p>	<p>2. IR 2 Blaster: Plug the IR Blaster cable for IR signal being transmitted. Place IR Blaster within direct site of the device being controlled.</p>
<p>3. RS-232: Connect to a device that has the ability to Receive control commands via RS232 only with compatible Transmitters.</p>	<p>4. IR 1 Extender: Plug the IR Extender cable for IR signal being received. Place IR Extender within direct line of site with the IR Remote.</p>

INPUT PANEL (Receiver HBT-C6PLT-R) Rear

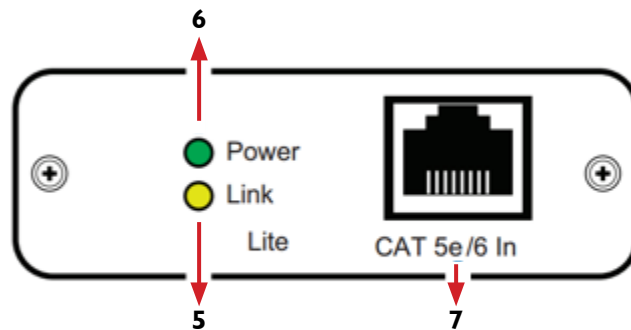

<p>5. LED Power: Illuminates when connected to the Tx with Power (POE initialized)</p>	<p>6. CAT5e/6/7 IN Connect CAT5e/6/7 cable to extend the signal up to 60m (200ft)</p>
<p>7. LED LINK: Illuminate when both the input and output signals are in sync.</p>	



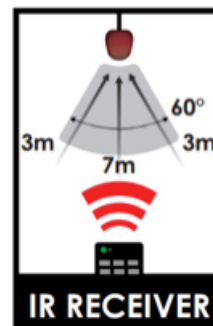
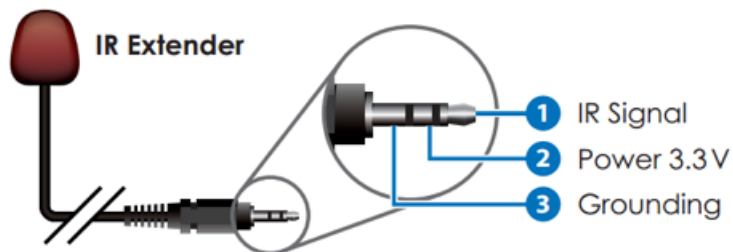
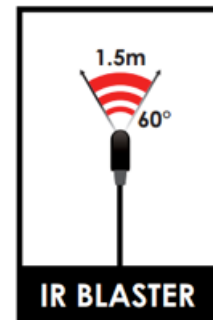
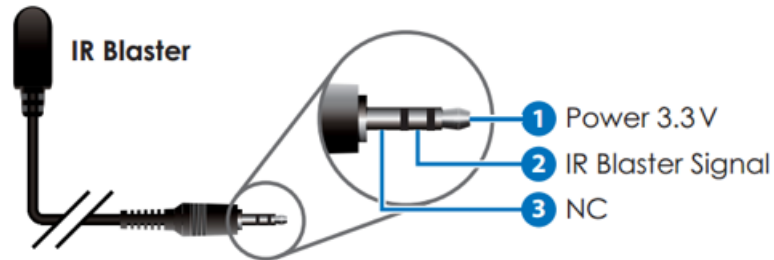

IR Sockets

- IR BLASTER: plug in the IR blaster to the HBT-C6PLT-R to emit all IR command signals received from the IR Extender plugged into the Rx (Monitor Side) to control the devices corresponding to the IR signals. Example: Set Top Box or DVD player (The Source).
- IR EXTENDER: plug in the IR Extender into the (RX) Receiver (Monitor Side) to receive all IR command signals from the IR remote controls of the corresponding source. Example: Set Top Box or DVD player (IR Remote Control).

WARNING

- NOTE: Incorrect placement of IR Blaster and IR Extender into the extender may result in the failure of the IR extenders.
- Please check carefully before plugging in the IR extender to the respective IR sockets.
- It is clearly marked and IR IN: IR EXTENDER / IR OUT: IR BLASTER
- WARRANTY WILL NOT COVER THE DAMAGE.



6. INSTALLATION (HBT-C6PLT-R)

To setup Avenview HBT-C6PLT-R please follow these steps for connecting to a device:

1. Turn off all devices including monitors / TV
2. Connect to a HDMI source (such as a Blu-Ray Disc player) to the Transmitter HBT-C6POE-SP4/8 or Matrix 4x4/8x8
3. Connect HBT-C6PLT-R 60m or HBT-C6POE-R 100m with a CAT5/6/7 cable with shielded ends, then connect to display with HDMI cable.
4. Plug in Power for the Tx.
5. Plug in the IR BLASTER: into IR out and the blinker on the IR eye (Source)
6. Plug in the IR Extender to IR IN to receive IR Signals from Remote
7. Power on the HDMI display
8. Power on HDMI Sources.

Notice

*NOTE: The QUALITY and TRANSMISSION of the video signals depends on the characteristics and quality of the UTP cables. Higher resolutions and longer transmission distances require low skew cables (<25ns/100m) for best performance.
Unshielded CAT6 with metal RJ-45 connectors is recommended.*



7. GENERAL TROUBLESHOOTING

PROBLEM	POSSIBLE SOLUTION
NO IMAGE	<ul style="list-style-type: none"> • Check if connection to the source and the display are correct. • Ensure that display device supports 480p, 720p and 1080p 4K@30 resolution • Terminated to 568B standard with Shielded Ends Recommended • High Quality CAT5/6/7 Cable helps signal transmission • Please use the supplied power supply-DC 24V 2.7A • Check LED Link light see (Section 3 Panel Description) • Check LED Sync light see (Section 3 Panel Description)
EDID ISSUE	<ul style="list-style-type: none"> • EDID MODE-TV: The default factory setting is on TV. The unit will detect the 1st CAT5e/6/7 output's EDID. When obtained a (4K2K) Ultra HD 3840x2160 EDID the signal is transmitted. • If the 1st CAT5e/6/7 output is without a Ultra HD 3840x2160 EDID the unit will detect all output's EDID and Transmit the signal that all outputs can accept. • EDID MODE-STD: Switch to STD to use built-in EDID if the display has No Image. STD EDID's video at 1080p@60Hz and audio at LPCM 2CH.
SET-TOP BOX NO PICTURE	<ul style="list-style-type: none"> • HDBaseT and HDMI 1.3 standards support CLOCK STRETCHING for i2c buss protocol • Example set top boxes like Scientific Atlantic results no picture. This can be resolved by swapping out the box for a newer version that supports HDMI 1.3 not HDMI 1.2
NO INFRARED COMMUNICATION	<ul style="list-style-type: none"> • Ensure the UTP cable is run within the wall away from EMI and High Voltage power Lines. • Please check manual of device to ensure proper placement of IR Blaster on IR EYE. • Some LED /Plasma TV have EMI interference with the IR Extender, please place the IR Rx 3-6" away from Screen
Recommended TEST	
END-TO-END TESTING	HDBaseT system, a final end-to-end test of all the A/V components should take place. These tests include checking the HDMI stream at the far end (sink end), the clock rate, frame compare, video pattern, audio, EDID and HDCP with Quantum 780 (recommended)
PASSIVE MONITORING	Passive monitoring enables an integrator to view the HDCP transactions, EDID exchange, as well as the connection events between the actual devices in the network.

NOTE

Additional info on Guidelines to Test & Troubleshoot HDBaseT Systems
Can be retrieved from our website under the category Downloads for this product HBT-C6PLT-R



8. SPECIFICATIONS

Item	Description
UNITS	HBT-C6PLT-R
UNIT DESCRIPTION	HDBaseT HDMI Receiver
HDMI COMPLIANCE	YES HDBaseT
HDCP	Yes
VIDEO BANDWIDTH	Single-link 340MHz [9 Gbps]
SUPPORTED RESOLUTIONS	4480i / 480p / 720p / 1080i / 1080p60 / 4K@30 Up to Ultra HD (3840x2160@24/25/30Hz) 4K2K-(4096x2160@24Hz)
CEC SUPPORT	ALLOWS CEC BYPASS
CAT5/6/7 CABLE	4K2K: (3840X2160@30Hz) ~ 35meter (115feet) (CAT6e/6a) FULL HD: (1080p) ~ 60meter (200feet) (CAT6e/6a)
AUDIO SUPPORT	LPCM 7.1CH, Dolby TrueHD, Dolby Digital Plus and DTS-HD Master Audio
INPUT TMDS SIGNAL	1.2 Volts (peak-to-peak)
INPUT DDC SIGNAL	5 Volts (peak-to-peak, TTL)
ESD PROTECTION	Human body model — ±8kV (air-gap discharge) & ±4kV (contact discharge)
INPUT	1x 3.5mm IR Extender 1x CAT5e/6/7
OUTPUT	1x RS-232 1x 3.5mm IR 1x HDMI
HDMI CONNECTOR	Type A (19 pin female)
LED	GREEN LED YELLOW LED
IR FREQUENCY	30~50kHz
DIMENSIONS (L X W X H)	2.8" x 2.9" x 1" 71 mm (L)×73.5mm (W)×23 mm (H)
WEIGHT	0.3lbs 126g
POWER SUPPLY	24V / 1.25A DC (US/EU standards, CE/FCC/UL certified)
POWER CONSUMPTION	6 Watt (max)

Environmental

OPERATING TEMPERATURE	32° ~ 104° F (0° to 40° C)
STORAGE TEMPERATURE	-4° ~ 140° F (-20° ~ 60° C)
RELATIVE HUMIDITY	20~90% RH (non-condensing)



Notice

- All HDMI over CAT5 transmission distances are measured using Belden CAT6A (625MHz), 4-Pair, U/UTP-Unshielded, Riser-CMR, Premise Horizontal Cable, 23 AWG Solid Bare Copper Conductors, Polyolefin Insulation, Patented Double-H spline, Ripcord, PVC Jacket using Quantum 980 signal HDMI Video Generator Module Video Pattern Testing.
- 2. The transmission length is largely affected by the type of category cables, also the type of HDMI sources, and the type of HDMI display. The testing result shows solid UTP cables (usually in the form of 300m or 1000ft bulk cable) can transmit a lot longer signals than stranded UTP cables (usually in the form of patch cords). Shielded STP connectors are better suit than unshielded UTP connectors. A solid UTP CAT5e cable shows longer transmission length than stranded STP CAT6 cable. For long extension users, solid cables are your only choice.
- 3. EIA/TIA-568-B termination (T568B) for category cables is recommended for better performance.
- 4. To reduce the interference among the unshielded twisted pairs of wires in category cable, you can use shielded STP cables with shielded connector to improve EMI problems, which occurs in long transmission.
- 5. Because the quality of the category cables has the major effects in how long transmission distance will be made and how good is the received display, the actual transmission length is subject to your category cables. For resolution greater than 1080i or 1280x1024, a solid CAT6 cable is the only viable choice.

PERFORMANCE GUIDE FOR HDMI OVER CATEGORY CABLE TRANSMISSION

PERFORMANCE RATING		TYPE OF CATEGORY CABLE		
WIRING	SHIELDING	CAT5	CAT5E	CAT6
SOLID	UNSHIELDED (UTP)	****	*****	*****
	SHIELDED (STP)	***	****	****
STRANDED	UNSHIELDED (UTP)	*	**	**
	SHIELDED (STP)	**	*	**
TERMINATION		PLEASE USE EIA/TIA-568-B TERMINATION (T568B) AT ANY TIME		



Notes



Avenview Warranty Certificate

AVENVIEW CORP. ("Avenview") warrants Avenview-branded product(s) contained in the original packaging against defects in materials and workmanship when used normally in accordance with Avenview's enclosed manual guidelines for a period of THREE (3) YEARS from the date of original retail purchase - Warranty Period. Avenview's published guidelines include but are not limited to information contained in technical specifications, user manuals and service communications.

LABOR: During the Warranty Period of THREE (3) YEARS, Avenview will repair or replace the product(s) at no cost using new or used parts equivalent to novel performance and reliability if the product(s) is determined to have abide by Avenview's published guidelines. Cost of Labor applicable to product(s) after Warranty Period. For labor costs, please contact support@avenview.com.

PARTS: During the Warranty Period of THREE (3) YEARS, Avenview will supply new or rebuilt replacements in exchange for defective parts of the product(s) at no cost if the product(s) is determined to have abide by Avenview's published guidelines. Cost of Parts applicable to product(s) after Warranty Period. For part(s) costs, please contact support@avenview.com.

To obtain Warranty: (a) proof of purchase in the form of a bill of sale or receipted invoice reflecting that the registered product(s) is within warranty period must be presented to obtain warranty service; (b) product(s) must be registered at time of purchase. Failure to do so will result in applicable parts and labor charges. Returning product(s) must be shipped in Avenview's original packaging or in packaging pertaining equal degree of protection to Avenview's. Both Avenview and purchaser are responsible for freight charges and brokerages when shipping the product(s) to the receiver.

NOT COVERED BY THIS WARRANTY

This warranty does not apply to any non-Avenview branded product(s); non-registered Avenview product(s). This warranty does not apply: (a) to cosmetic damage, including but not limited to scratches, dents and broken cords; (b) to damage caused by use with another product; (c) to damage caused by accident, abuse, misuse, liquid contact, fire, earthquake or other external cause; (d) to damage caused by operating the Avenview product(s) outside Avenview's manuals or guidelines; (e) to damage caused by service performed by anyone who is not a representative of Avenview or an Avenview authorized personnel; (f) to defects caused by normal wear and tear or otherwise due to the normal aging of the Avenview product(s), or (g) if any serial number has been removed or defaced from the Avenview product(s).

AVENVIEW IS NOT LIABLE FOR DIRECT, SPECIAL, INCIDENTAL OR CONSEQUENTIAL DAMAGES RESULTING FROM ANY BREACH OF WARRANTY OR CONDITION, OR UNDER ANY OTHER LEGAL THEORY, INCLUDING BUT NOT LIMITED TO LOSS OF USE; LOSS OF REVENUE; LOSS OF ACTUAL OR ANTICIPATED PROFITS (INCLUDING LOSS OF PROFITS ON CONTRACTS); LOSS OF THE USE OF MONEY; LOSS OF ANTICIPATED SAVINGS; LOSS OF BUSINESS; LOSS OF OPPORTUNITY; LOSS OF GOODWILL; LOSS OF REPUTATION; LOSS OF, DAMAGE TO, COMPROMISE OR CORRUPTION OF DATA; OR ANY INDIRECT OR CONSEQUENTIAL LOSS OR DAMAGE REPAIR OR REPLACEMENT AS PROVIDED UNDER THIS WARRANTY IS THE EXCLUSIVE REMEDY OF THE CONSUMER.

Some states do not allow the inclusion or limitation of incidental or consequential damages, or allow limitations on duration implements of the Warranty Period; therefore the above limitations or exclusions may not be applicable to you. This warranty gives you specific legal rights, and you may have other rights which vary from state to state.



275 Woodward Avenue, Kenmore, NY 14217
1.866.508.0269





AV Connectivity, Distribution And Beyond...

TECHNICAL SUPPORT

CONTACT US



Phone: 1 (866) 508 0269



Email: support@avenview.com



USA Head Office Avenview Corp. 275 Woodward Avenue Kenmore, NY 14217

USA Head Office

Office Avenview
Corp. 275 Woodward Avenue
Kenmore, NY 14217
Phone: +1.716.218.4100 ext223
Fax: +1.866.387-8764
Email: info@avenview.com

Canada Sales

Avenview
151 Esna Park Drive, Unit 11 & 12
Markham, Ontario, L3R 3B1
Phone: 1.905.907.0525
Fax: 1.866.387.8764
Email: info@avenview.com

Avenview Europe

Avenview Europe
Demkaweg 11
3555 HW Utrecht
Netherlands
Phone: +31 (0)85 2100- 613
Email: info@avenview.eu

Avenview Hong Kong

Unit 8, 6/F, Kwai Cheong Centre,
50 Kwai Cheong Road,
Kwai Chung, N.T.
Hong Kong
Phone: 852-3575 9585
Email: wenxi@avenview.com

Disclaimer

While every precaution has been taken in the preparation of this document, Avenview Inc. assumes no liability with respect to the operation or use of Avenview hardware, software or other products and documentation described herein, for any act or omission of Avenview concerning such products or this documentation, for any interruption of service, loss or interruption of business, loss of anticipatory profits, or for punitive, incidental or consequential damages in connection with the furnishing, performance, or use of the Avenview hardware, software, or other products and documentation provided herein.

Avenview Inc. reserves the right to make changes without further notice to a product or system described herein to improve reliability, function or design. With respect to Avenview products which this document relates, Avenview disclaims all express or implied warranties regarding such products, including but not limited to, the implied warranties of merchantability, fitness for a particular purpose, and non-infringement.