











Power Sockets for TBUS products





Congratulations on purchasing your Kramer Table Connection Bus (**TBUS-1AXL, TBUS-3XL, TBUS-4XL, TBUS-5XL, TBUS-6XL, TBUS-10XL, TBUS-18XL** and/or **UTBUS-1XL**).

Some inner frame modules require single or dual power sockets. A choice of one or more power sockets per inner frame is available in several versions, including power sockets for the USA, the UK, Germany (the Europlug), Belgium-France, Italy, Switzerland, South Africa, Israel, Brazil and Australia. A "Universal" socket for general use is also available (see the compatibility restrictions in the table below).

Note that Brazilian power sockets are supplied as dual power sockets in a single power socket assembly (see the table below).

The Single Power Socket Assemblies

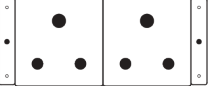
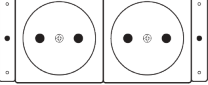
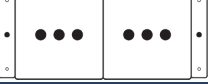
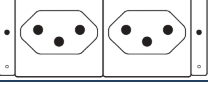
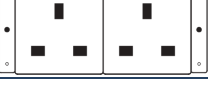
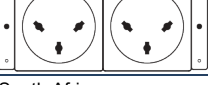
Power Socket Type	Power Specs	Power Socket Type	Power Specs
Universal: 	TS-1U (80-000899) 100-240V AC, 50/60Hz, 5A Maximum 5A per power outlet	Fully compatible with power plugs in the UK, India, Italy and Denmark, as well as with the 2-prong Europlug. Partially compatible (if the polarity is reversed) with plugs in China, Switzerland, Israel and the USA. The universal socket does not supply grounding to plugs in Central Europe and France and so you should order country specific sockets instead. Not compatible with South African plugs.	
USA: 	TS-1US (80-000999) 100-240V AC, 50/60Hz, 5A Maximum 5A per power outlet	UK 	TS-1UK (91-000022) 100-240V AC, 50/60Hz, 5A Maximum 5A per power outlet
Belgium and France: 	TS-1FR (80-001399) 100-240V AC, 50/60Hz, 5A Maximum 5A per power outlet	Israel: 	TS-1IL (80-001799) 220V AC, 50/60Hz, 5A Maximum 5A per power outlet
Germany and EU: 	TS-1DE (80-001299) 100-240V AC, 50/60Hz, 5A Maximum 5A per power outlet	South Africa 	TS-1ZA (80-001699) 100-240V AC, 50/60Hz, 5A Maximum 5A per power outlet
Italy: 	TS-1IT (80-001499) 100-240V AC, 50/60Hz, 5A Maximum 5A per power outlet	Australia: 	TS-1AU (80-001599) 100-240V AC, 50/60Hz, 5A Maximum 5A per power outlet
Switzerland 	TS-1CH (80-000027) 100-240V AC, 50/60Hz, 5A Maximum 5A per power outlet	Brazil 	TS-2BR (80-000034) 100-240V AC, 50/60Hz, 5A Maximum 5A/2.5A per power outlet

Dual Power Socket Assemblies:	Power Specs
Universal: 	TS-2U (80-001899) 100-240V AC, 50/60Hz, 5A Maximum 5A/2.5A per power outlet
USA: 	TS-2US (80-001999) 100-240V AC, 50/60Hz, 5A Maximum 5A/2.5A per power outlet
Belgium and France: 	TS-2FR (80-002299) 100-240V AC, 50/60Hz, 5A Maximum 5A/2.5A per power outlet
Germany and EU: 	TS-2DE (80-002199) 100-240V AC, 50/60Hz, 5A Maximum 5A/2.5A per power outlet
Italy 	TS-2IT (80-002399) 100-240V AC, 50/60Hz, 5A Maximum 5A/2.5A per power outlet
Switzerland 	TS-2CH (80-000026) 220V AC, 50/60Hz, 5A Maximum 5A/2.5A per power outlet
UK 	TS-1UK (91-000023) 220V AC, 50/60Hz, 5A Maximum 5A/2.5A per power outlet
Israel: 	TS-2IL (80-002699) 220V AC, 50/60Hz, 5A Maximum 5A/2.5A per power outlet
South Africa: 	TS-2ZA (80-002599) 220V AC, 50/60Hz, 5A Maximum 5A/2.5A per power outlet
Australia: 	TS-2AU (80-002499) 100-240V AC, 50/60Hz, 5A Maximum 5A/2.5A per power outlet

Power Cord Options

You can order any of the following power cords to use with a modular TBUS:

Power Cord Type	Description	P/N
6ft/110V (North America)	C-AC/US (110V)	91-000099
6ft/125V (Japan)	C-AC/JP (125V)	91-000699
6ft/220V (Europe)	C-AC/EU (220V)	91-000199
6ft/220V (Israel)	C-AC/IL (220V)	91-000999
6ft/250V (UK)	C-AC/UK (250V)	91-000299
6ft/250V (India)	C-AC/IN (250V)	91-001099
6ft/250V/10A (China)	C-AC/CN (250V)	91-001199
6ft/250V/10A (South Africa)	C-AC/ZA (250V)	91-001299

To use one power cord for a 4-socket configuration, you can order any of the following types of power cords separately:

Power Cord Type	Description	P/N
110V Y-version (6ft), North America	C-ACY/US	91-000399
220V Y-version (6ft), Europe	C-ACY/EU	91-000499
240V Y-version (6ft), UK	C-ACY/UK	91-000599

Installation Instructions

Before installing the inner frame, you need to install the power sockets. To do so:

1. Insert the power socket module into the power socket opening from beneath.
2. Use the two power socket screws to tighten the power socket in place.
The power socket is installed and ready to use.

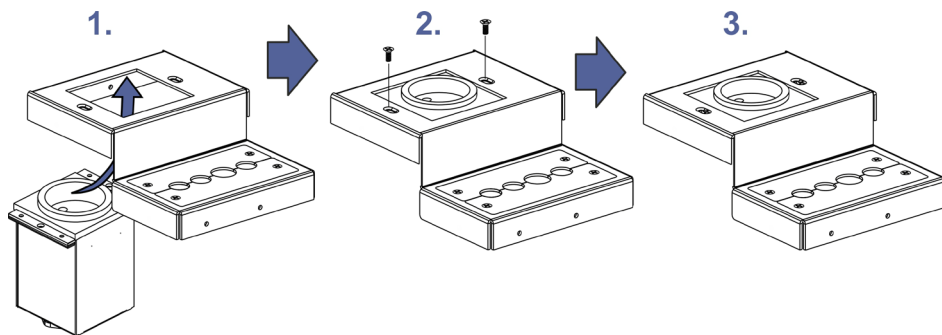

Figure 1: Power Socket Installation



KRAMER ELECTRONICS LTD.

Installation Instructions

MODELS:

Power Socket Installation
for Inner Frame

Power Cord Options
for Modular TBUS

For the latest information on our products and a list of Kramer distributors, visit our Web site where updates to these installation instructions may be found

We welcome your questions, comments, and feedback.

Web site: www.kramerelectronics.com
E-mail: info@kramerel.com

For more detailed information regarding this product scan the QR code:

! SAFETY WARNING
Disconnect the unit from the power supply before opening and servicing

P/N: 2900-300061 Rev 4

P/N: 2900-300061 Rev: 4