



# AUDIO CENTRALIZER WITH STEREO MATRIXING

AC-AEX-RC-HUB

User Manual

# CONTENTS

Contents .....	2
Important Safety Instructions.....	4
Introduction.....	6
Compatible Devices.....	6
AC-AEX-T.....	6
Product Overview.....	7
Box Contents.....	7
Technical Specifications.....	7
Front and Rear Panels.....	8
Installation.....	9
Rack Mounts.....	9
Mounting Feet Assembly.....	9
Grounding Cable.....	10
Front Panel Control.....	10
View Input/Output Mapping.....	10
Configure Mode.....	10
Wiring and Connections.....	11
Audio Connections.....	11
RS-232 Control.....	12
LAN Wiring.....	12
Initial Setup.....	13
Connecting the Devices.....	13
Locating the IP Address.....	13
Accessing the Web UI.....	14
OTA Cloud Services.....	14
Navigating the Web UI.....	16
Matrix.....	17
Matrix Switching.....	17
I/O Config.....	18
Stereo Audio Input Settings.....	18
Stereo Audio Output Settings.....	18
Output Following.....	19
Audio Configuration.....	20

System .....	21
IP Settings .....	21
IP Control .....	22
Admin Web Interface.....	22
User Web Interface.....	23
Cloud Services.....	24
Hardware.....	25
Console.....	26
Command List .....	26
Troubleshooting .....	28
Maintenance .....	28
Damage Requiring Service .....	28
Support .....	29
Warranty .....	29
The Basics .....	29
Coverage Details.....	29
Red Tape.....	29
Obtaining an RMA.....	30
Shipping.....	30
Limitation on Liability.....	30
Exclusive Remedy .....	31





## IMPORTANT SAFETY INSTRUCTIONS

Before installing, configuring, and operating the devices and other vendor equipment, AVPro Edge recommends that each dealer, integrator, installer, and all other necessary personnel access and read all the required technical documentation, which can be located by visiting [AVProEdge.com](http://AVProEdge.com).

**Read and understand all safety instructions, cautions, and warnings in this document and the labels on the equipment.**

### Safety Classifications in this Document

---

 <b>NOTE:</b>	Provides special information for installing, configuring, and operating the devices.
 <b>TIP:</b>	Provides suggestions and considerations for installing, configuring, and operating the devices.
 <b>IMPORTANT:</b>	Provides special information that is critical for installing, configuring, and operating the equipment.
 <b>CAUTION:</b>	Provides special information for avoiding situations that may cause damage to the devices.
 <b>WARNING:</b>	Provides special information for avoiding situations that may cause physical danger to the installer, end user, etc.

---

### Electrical Shock Prevention

 **ELECTRIC SHOCK:**

The source power poses an electrical shock hazard that can potentially cause serious injury to installers and end users.

 **ELECTRICAL DISCONNECT:**

The source power outlet and power supply input power sockets should be easily accessible to disconnect power in the event of an electrical hazard or malfunction.

### Weight Injury Prevention

 **WEIGHT INJURY:**

Installing some of the MXNet devices requires two installers to ensure safe handling during installation. Failure to use two installers may result in injury.

## Safety Statements

Follow all of the safety instructions listed below and apply them accordingly. Additional safety information will be included where applicable.

1. Read these instructions.
2. Keep these instructions.
3. Heed all warnings.
4. Follow all instructions.
5. Do not use these devices near water.
6. Clean only with a dry cloth.
7. Do not block any ventilation openings. Install in accordance with the manufacturer's instructions.
8. Do not install near any heat sources such as radiators, heat registers, stoves, or other apparatus (including amplifiers) that produce heat.
9. Do not defeat the safety purpose of the polarized or grounding-type plug. A polarized plug has two blades with one wider than the other. A grounding-type plug has two blades and a third grounding prong. The wide blade or third prong are provided for your safety. If the provided plug does not fit into your outlet, consult an electrician for replacement of the obsolete outlet.
10. Protect the power cord from being walked on or pinched particularly at plugs, convenience receptacles, and the point where they exit from the devices.
11. Only use attachments and accessories specified by the manufacturer.
12. Unplug these devices during lightning storms or when unused for long periods of time.
13. To reduce the risk of electric shock or damage to these devices, never handle or touch the devices and power cord if your hands are wet or damp. Do not expose these devices to rain or moisture.
14. Refer all servicing to qualified service personnel. Servicing is required when the devices have been damaged in any way, such as power supply cord or plug is damaged, liquid has been spilled, objects have fallen into the devices, the devices have been exposed to rain or moisture, does not operate normally, or has been dropped.
15. The devices and their accessories should never be exposed to open flames or excessive heat.

# INTRODUCTION

The AC-AEX-RC-HUB is a 12 I/O 1U rack-mountable audio recall centralizer with stereo matrix switching. Designed to receive extended audio over PoC, uncompressed TOSLINK digital audio, and line-level analog stereo audio signals from up to 12 source devices, the AC-AEX-RC-HUB retrieves remote audio source signals back to a centrally located audio distribution system, such as an equipment rack, with a maximum distance of up to 130 meters (426 feet).

The diagram below shows the basic application of the AC-AEX-RC-HUB. The audio path can either come from the audio sources directly, or from a separate output (non-HDMI) like the AC-AEX-T as shown below.

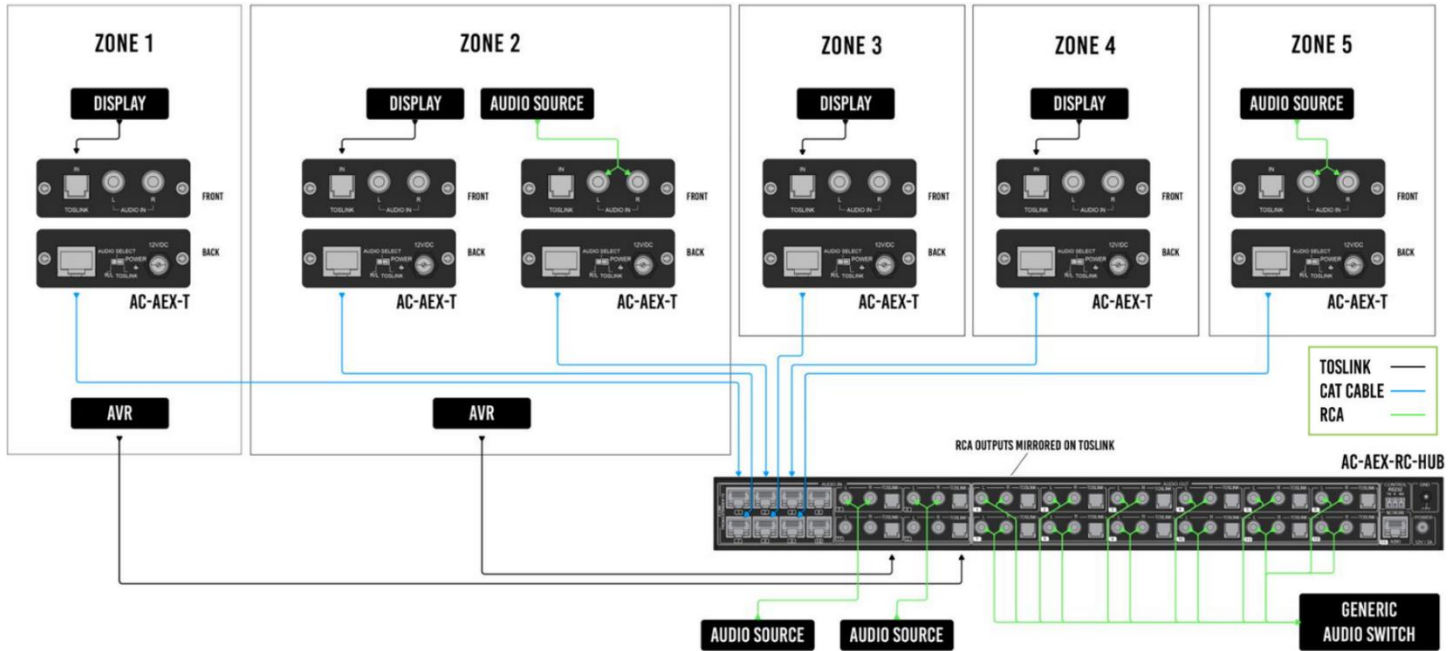

## Compatible Devices

### AC-AEX-T (sold separately)

The AVPro Edge AC-AEX-T is a digital/analog audio transmitter that extends stereo signals over a single Category cable with PoC (Power over Cable) when connected to the AC-AEX-RC-HUB. Ideal for sending audio from a source device located in a separate zone to a centrally located audio distribution system.

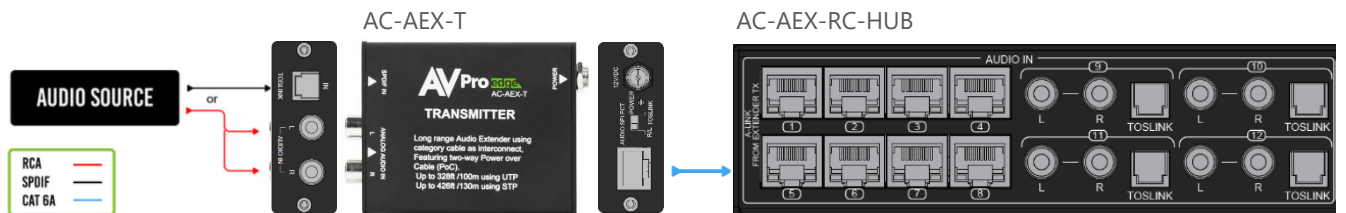

**⚠ IMPORTANT:** Each A-LINK port on the AC-AEX-RC-HUB must be paired with an AC-AEX-T audio extender transmitter for complete operation.

# PRODUCT OVERVIEW

## Box Contents

- (1x) AC-AEX-RC-HUB Audio Centralizer
- (2x) 1U Rack Mounting Brackets (pre-assembled)
- (1x) 3-Pin Terminal Block Connector
- (4x) Mounting Feet
- (4x) Mounting Feet Screws
- (1x) Ground Wire
- (1x) Power Supply

## Technical Specifications

Audio	
Analog Input Voltage	0.8 VRMS, 2.3 VPP
Analog Output Voltage	1 VRMS, 2.828 VPP
Digital	2-Channel PCM
Supported Sample Rates	32 kHz, 44.1 kHz, 48 kHz, 88.2 kHz, 96 kHz, 176 kHz, 192 kHz
Latency	30ms
Mute	Available on all outputs
Audio Inputs	
AEX Audio	8
RCA	4
Digital (TOSLINK)	4
Audio Outputs	
AEX Audio	0
RCA	12
Digital (TOSLINK)	12
Control	
Interfaces	RS-232, IP/LAN
Power	
Total Power Consumption	24 Watts Maximum
DC Power	DC 12V 2A
Dimensions	
Height x Width x Depth (Standalone Unit)	Millimeters: 44.45 x 444.5 x 234.95 Inches: 1.75 x 17.5 x 9.25
Height x Width x Depth (Packaged Unit)	Millimeters: 127 x 571.5 x 381 Inches: 5 x 22.5 x 15
Weight (Standalone Unit)	6.6 lbs (2.99 kg)
Weight (Packaged Unit)	9 lbs (4.08 kg)
Rack Space	1U
*Specifications are subject to change without notice. Mass and dimensions are approximate.	

## Front and Rear Panels

Front Panel

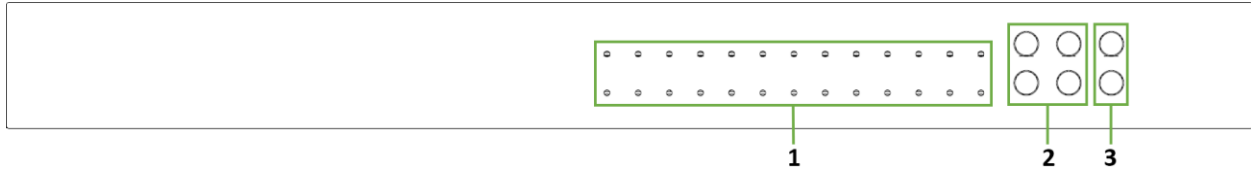

Rear Panel

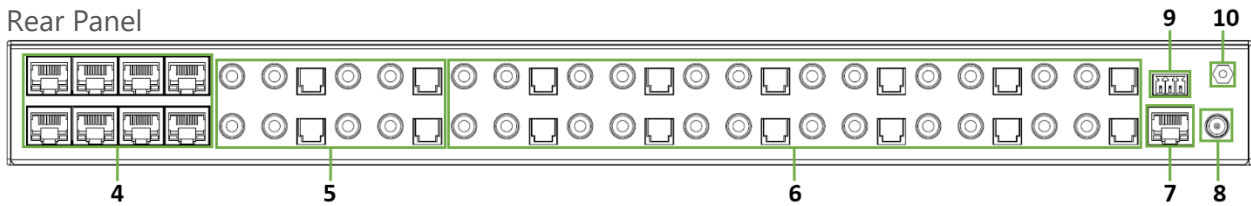

<b>1 INPUT and OUTPUT LEDs</b>	<ul style="list-style-type: none"> <li>Blue LED status indicator lights for the inputs and outputs</li> </ul>
<b>2 AUDIO CHANNEL SELECT</b>	<ul style="list-style-type: none"> <li>Navigation buttons to cycle through the inputs and outputs</li> </ul>
<b>3 CONTROL</b>	<ul style="list-style-type: none"> <li>Navigation buttons to confirm or exit the selected input and outputs</li> </ul>
<b>4 A-LINK FROM EXTENDER TX</b>	<ul style="list-style-type: none"> <li>(8x) 8-pin RJ-45 female connector</li> <li>Long-range audio extension input ports for connecting AC-AEX-T Power over Cable (PoC)</li> <li>Unshielded Twisted Pair (UTP): up to 100 meters (328 ft)</li> <li>Shielded Twisted Pair (STP): up to 130 meters (426 ft)</li> </ul> <p><b>⚠ IMPORTANT:</b> Each A-LINK port must be paired with an AC-AEX-T digital/analog audio extender transmitter for complete operation.</p>
<b>5 AUDIO IN</b>	<ul style="list-style-type: none"> <li>(4x) Stereo RCA line-level analog audio inputs</li> <li>(4x) TOSLINK (optical) digital audio inputs</li> </ul>
<b>6 AUDIO OUT</b>	<ul style="list-style-type: none"> <li>(12x) Stereo RCA analog audio outputs</li> <li>(12x) TOSLINK (optical) mirrored digital audio outputs</li> </ul>
<b>7 NETWORK</b>	<ul style="list-style-type: none"> <li>8-pin RJ-45 female connector</li> <li>Connect to the LAN, router, or third-party control system</li> <li>Future-use I/O support for web-based audio such as Josh.ai VoiceCast</li> </ul>
<b>8 POWER</b>	<ul style="list-style-type: none"> <li>DC 12V 2A locking ring power input</li> </ul>
<b>9 CONTROL RS232</b>	<ul style="list-style-type: none"> <li>3-pin terminal block connector port</li> </ul>
<b>10 GND</b>	<ul style="list-style-type: none"> <li>Ground screw</li> <li>Connect with the supplied ground wire to the conducting parts</li> </ul>



# INSTALLATION

## Rack Mounts

The AC-AEX-RC-HUB can be mounted in a 1U rack-style enclosure and is compatible with all standard 19-inch rack mounts. The (2x) mounting brackets are pre-assembled to the unit for quick installation.

- 1 Align the holes on the mounting brackets with the holes on both sides of the rack.
- 2 Attach the mounting brackets to the rack with rack screws (not included).

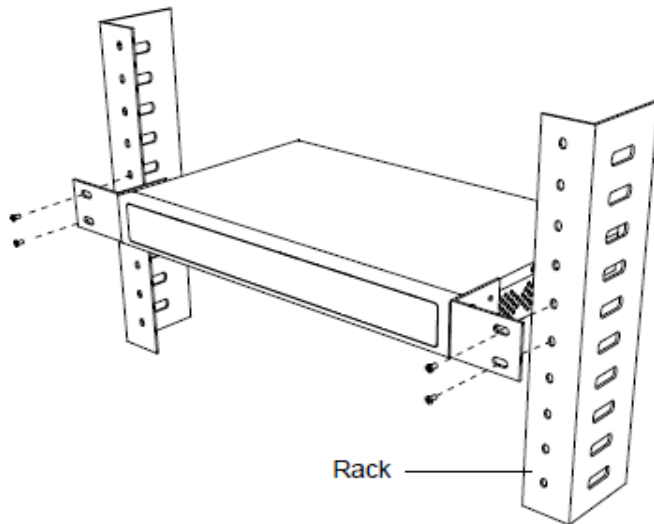

## Mounting Feet Assembly

The (4x) mounting feet can be assembled to the AC-AEX-RC-HUB with the (4x) provided mounting screws.

- 1 Align the holes on the mounting feet with the holes underneath the AC-AEX-RC-HUB.
- 2 Attach the mounting feet to the AC-AEX-RC-HUB with the provided screws.

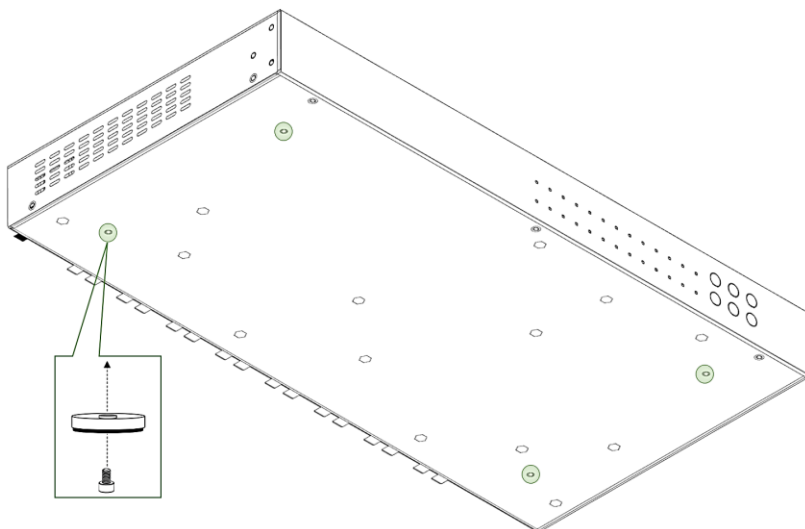

## Grounding Cable

Use a screwdriver to attach the yellow grounding cable to the pre-installed screw on the back of the unit, then attach the other end to a suitable grounded object.

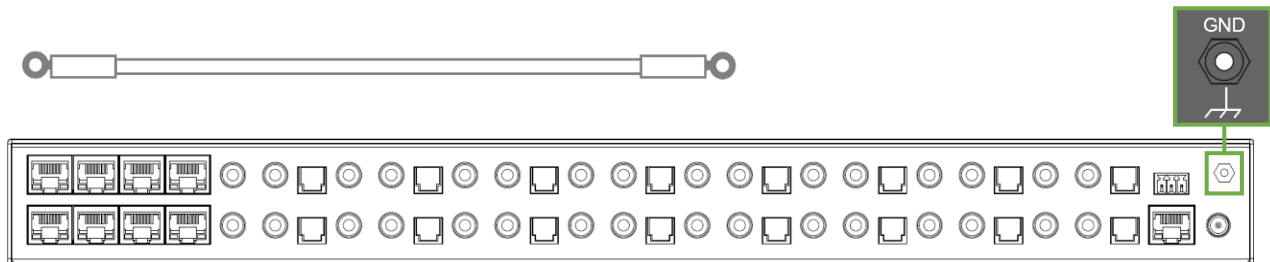

## FRONT PANEL CONTROL

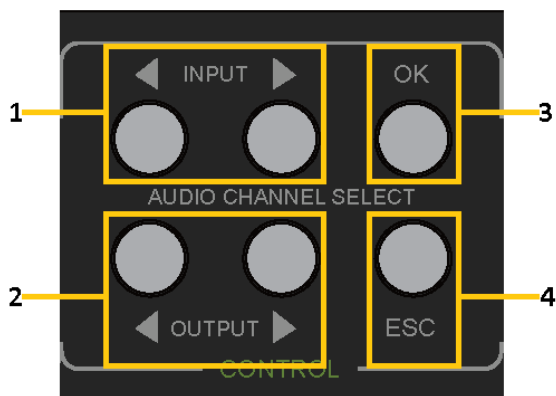

- 1 *Left and Right Input* buttons selects the desired input, indicated by a blue LED under the port number.
- 2 *Left and Right Output* buttons selects the desired output, indicated by a blue LED above the port number.
- 3 *OK* button enters the configuration mode and confirms the selected inputs and outputs.
- 4 *ESC* button exits configuration mode.

## View Input/Output Mapping

Use the front panel *Input Left* and *Right* buttons to navigate the blue LED to the desired input's port number. Output LEDs mapped to the selected input will then light up.

## Configure Mode

Press the *OK* button, this will light up one of the input LEDs and all output indicators will pulse on, followed by a blinking output LED. Press the *Left* and *Right Input* buttons to navigate the blue LED to the desired input. Next, press the *Left* and *Right Output* buttons to navigate the blue LED to the desired output. Press the *OK* button again to map the selected input to the selected output. Mapping is confirmed by a pulse of all output LEDs. Process is repeated until all inputs and outputs are mapped as desired or the *ESC* button is pressed. Mapping can be checked outside of configuration mode.

# WIRING AND CONNECTIONS

## Audio Connections

AVPro Edge recommends using shielded RCA interconnected cabling between the AC-AEX-RC-HUB and the connected analog devices to maintain a high level of audio performance.

The diagram below shows the audio connections of the AC-AEX-RC-HUB.

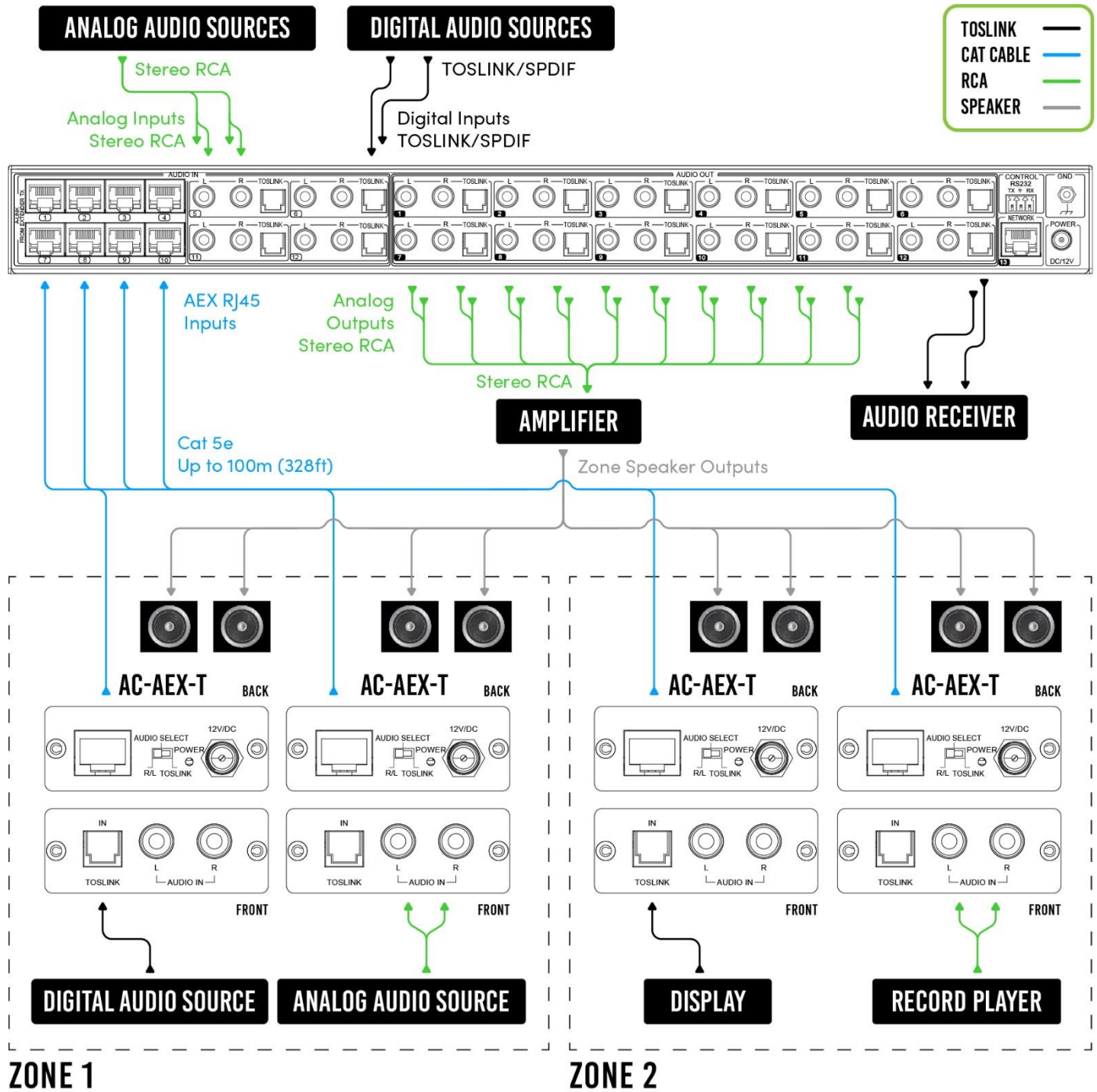

## RS-232 Control

The RS-232 control port located in the top right corner on the rear panel is used to communicate with the AC-AEX-RC-HUB via a computer or third-party control system.

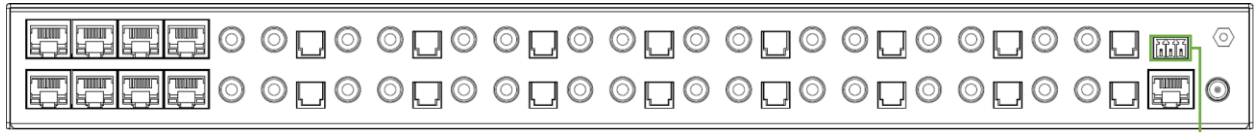

RS-232 Port

Wiring for this port uses a 3-pin terminal block connector to DB9 where only pins 2, 3, and 5 are used. If the control devices do not have a DB9 port, a USB to DB9 adapter may be required.

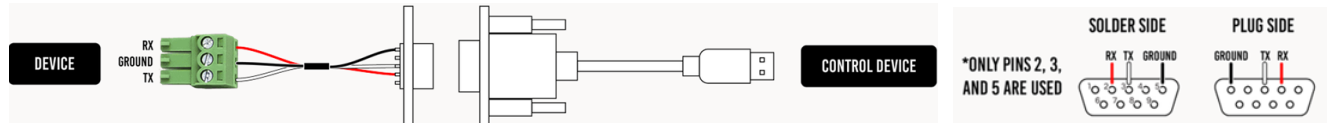

For RS-232 control, use a null modem serial cable adapter and set the serial communications to: Baud: 57600, no parity, 8 data bits, and 1 stop bit, with no handshaking.

Add a carriage return (Enter key) after each command when using direct commands. The unified command list (ASCII) can be located [here](#).

## LAN Wiring

The IP control port located in the bottom right corner on the rear panel is used to communicate with the AC-AEX-RC-HUB via a LAN, router, or third-party control system processor.

For TCP/IP control, commands use Telnet Port 23.

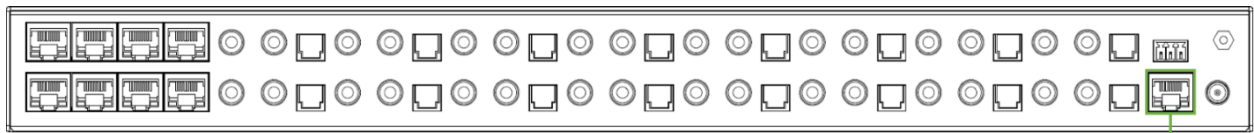

Network Port

The recommended termination is based on TIA/EIA T568A or T568B standards for the wiring of the twisted pair cables:

### T568A

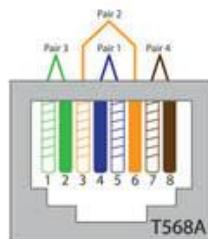
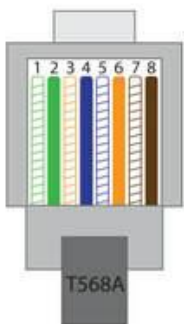

- PIN 1: GREEN/WHITE
- PIN 2: GREEN
- PIN 3: ORANGE/WHITE
- PIN 4: BLUE
- PIN 5: BLUE/WHITE
- PIN 6: ORANGE
- PIN 7: BROWN/WHITE
- PIN 8: BROWN

### T568B

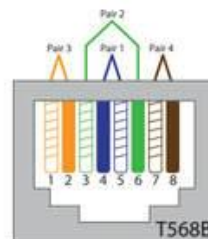
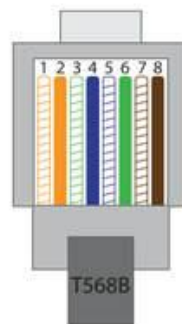

- PIN 1: ORANGE/WHITE
- PIN 2: ORANGE
- PIN 3: GREEN/WHITE
- PIN 4: BLUE
- PIN 5: BLUE/WHITE
- PIN 6: GREEN
- PIN 7: BROWN/WHITE
- PIN 8: BROWN

## INITIAL SETUP

Make the physical connections to the input and output devices using the following steps below. For initial setup, it is recommended to connect the AC-AEX-RC-HUB to a LAN (Local Area Network) using a control PC on the same network once all the physical connections are made, followed by accessing the Web UI and checking for any firmware updates to the unit.

### Connecting the Devices

- 1 Connect the audio source devices to the audio inputs on the back of the unit.

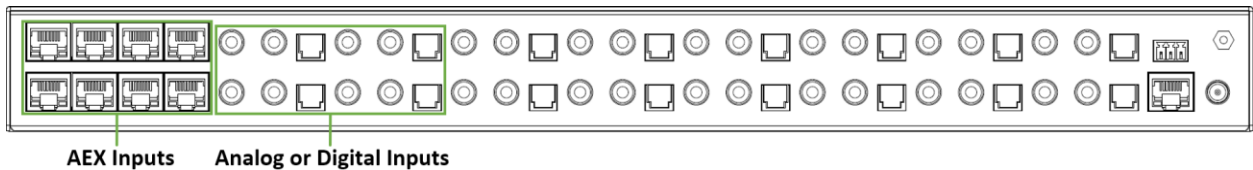

- 2 Connect the audio output devices to the audio outputs on the back of the unit.

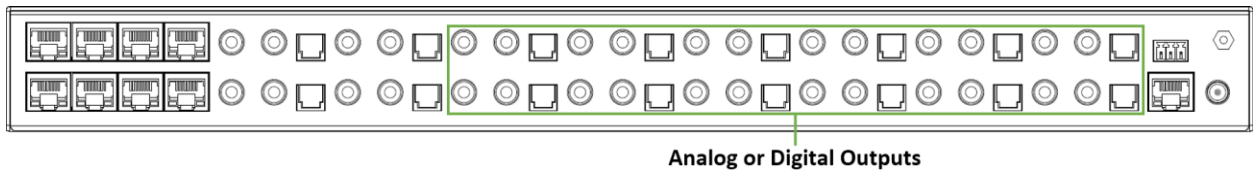

- 3 Connect the power port on the back of the unit to a suitable power source with the supplied power cable.

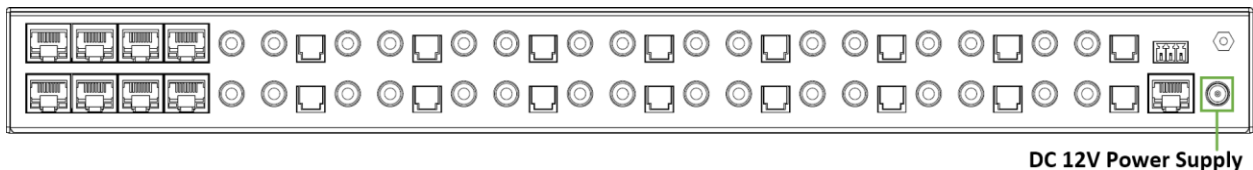

- 4 Connect the NETWORK port on the back of the unit to a LAN, router, or third-party control system.

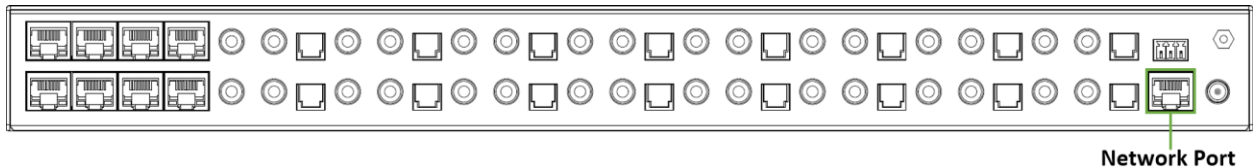

### Locating the IP Address

The default IP setting is DHCP mode, an IP address will automatically be assigned to the unit by the DHCP server within the router. Use a control PC on the same network to locate the unit's IP address, then enter it into a web browser (such as Chrome or Edge) to access the unit's Web UI. Once connected, you can use the Web UI to assign a new IP address or set the IP mode to static. If there is no DHCP server on the network, the unit's IP address can also be located by connecting to the RS-232 port on the back of the unit and sending serial commands using the API. For more information, see the *RS-232 Control* page.

## Accessing the Web UI

The AC-AEX-RC-HUB features the built-in AVPro Edge User Interface (AEUI) and can be accessed through a web browser for configuration and control. For initial setup, it is recommended to connect the AC-AEX-RC-HUB to a local area network (LAN) with a computer on the same network to access the built-in Web UI and check for any firmware updates to the unit.

### OTA Cloud Services

Firmware updates to the unit can be performed OTA (Over-the-Air) by enabling the *Cloud Services* setting on the Web UI. This allows the unit to search the Cloud for the latest versions of firmware. If a newer version is detected that what is currently installed on the unit, a dialog box will prompt the new update is available from the Web UI.

- 1 Enter in the unit's IP address into a Chrome or Edge web browser to access the unit's Web UI.

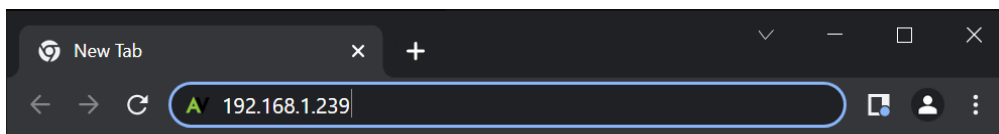

- 2 Navigate to the *System* tab page.

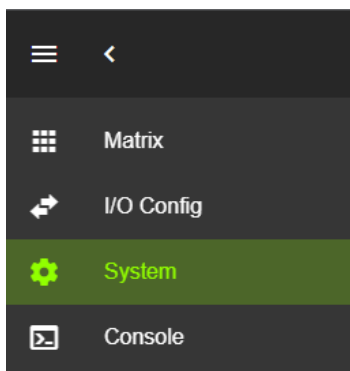

- 3 In the *Cloud Services* section, review the *Privacy Policy* and *Terms of Use*, then check both boxes and select the *Enable Cloud Services* toggle setting.

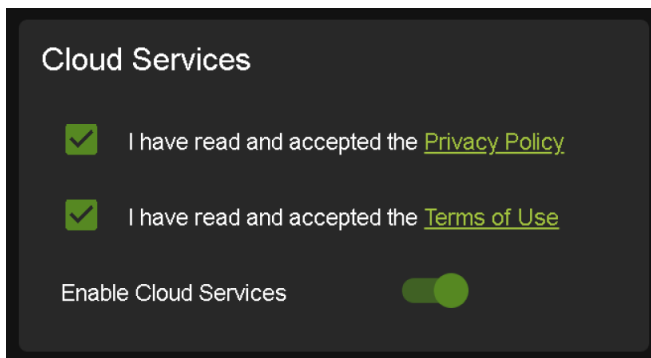

**⚠ IMPORTANT:** This is a required step in order for the unit to perform OTA firmware updates.

- If the unit is already installed with the latest version of firmware, a notification window will prompt the message "No update available!" at the top of the page.



- If a newer version of firmware is detected from the Cloud, a notification window will prompt the message "New firmware update is available!". Select the *Update* button.



- The unit's new firmware file will automatically populate into the *File input* field from the Cloud. Select the *Upload* button.

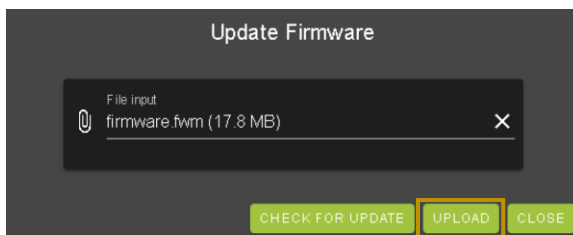

- From this screen, newer versions of firmware can be viewed before they are installed. Select the *Upgrade* button. The unit will now begin installing the latest versions of firmware. DO NOT refresh the webpage or power off the unit during the update.

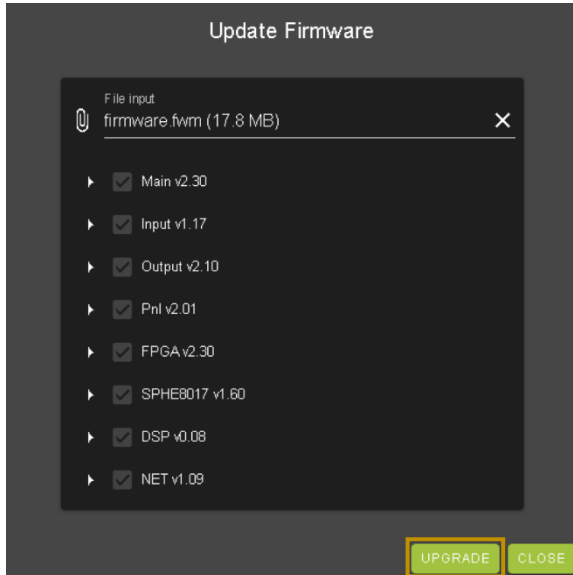



- Once the progress bar reaches 100%, select the *Close* button and refresh the webpage.
- The unit will automatically reboot once the firmware updates are complete. After the unit reboots, refresh the webpage to verify that the firmware update was successful.

## NAVIGATING THE WEB UI

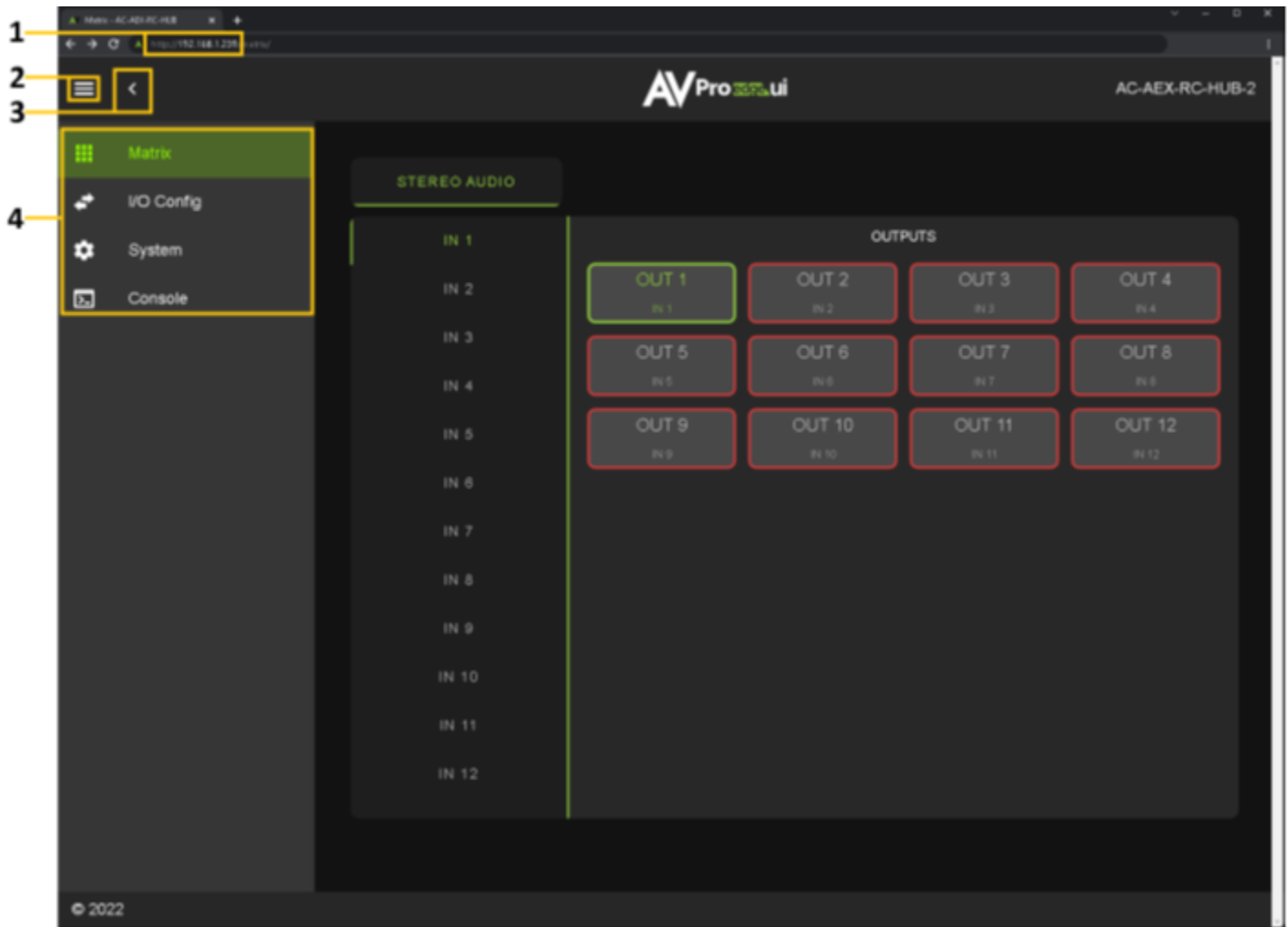
The AC-AEX-RC-HUB features the built-in AVPro Edge User Interface (AEUI) and can be accessed through a web browser for configuration and control. Different tools and settings can be selected from the tab pages located on the navigation menu column on the left side of the screen.



- 1 Enter the unit's IP address into a web browser, such as Chrome or Edge, to access the Web UI.
- 2 To hide the navigation menu, select the *hamburger menu* icon .
- 3 To hide the navigation menu text and show only the menu icons, select the *left arrow* icon .
- 4 To navigate through the different pages, select the individual *tab pages* from the navigation menu. This will highlight the tab page in green to indicate the currently selected page.

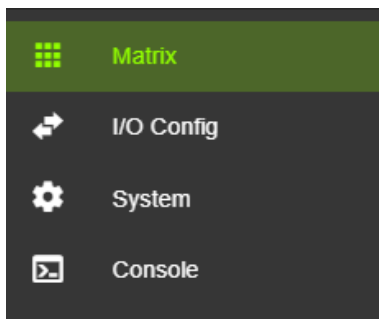



## Matrix

The **Matrix** page layout consists of the **Stereo Audio Inputs** column on the left and the **Outputs** grid on the right. Each *Input* and *Output* can be individually selected to route the input audio signals to the outputs.

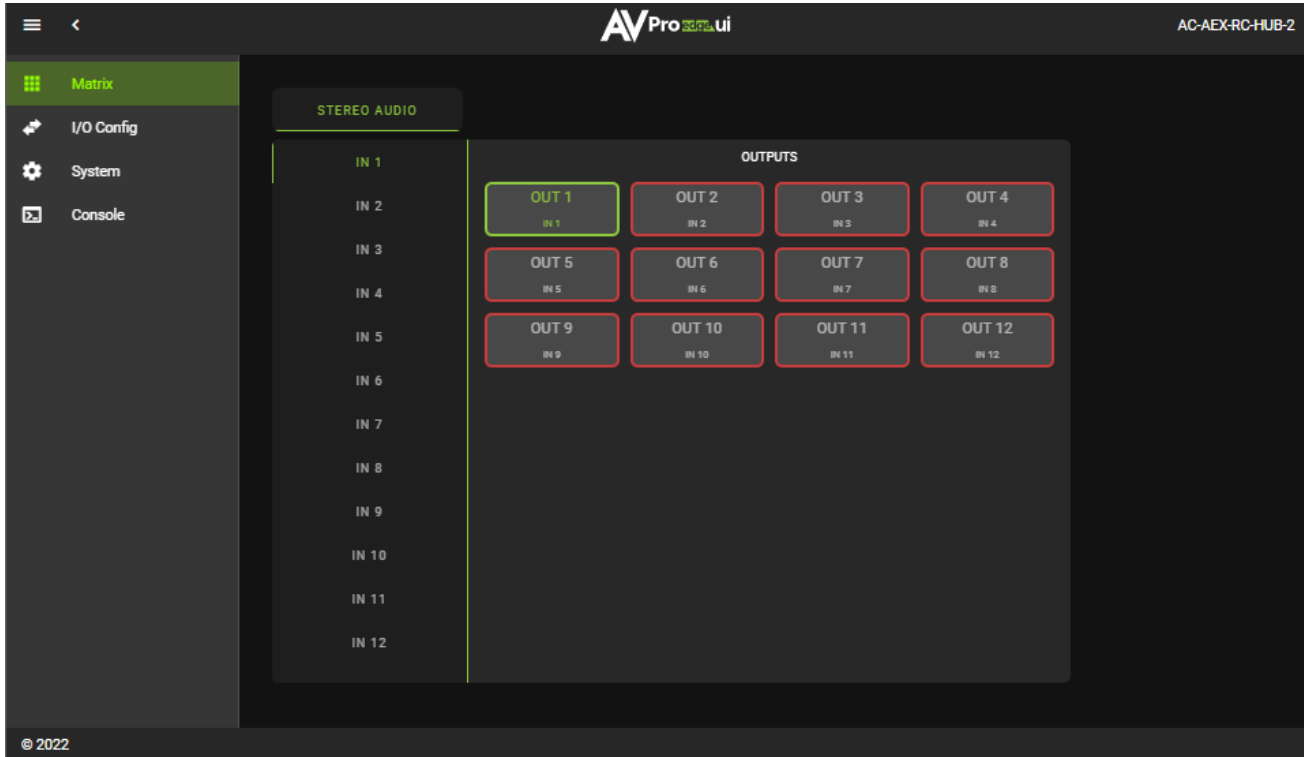

### Matrix Switching

- 1 From the *Inputs* column, select the desired input. This will highlight the input with a green text to indicate the selection was made.

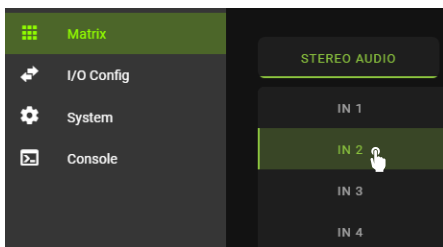

- 2 From the *Outputs* grid, select the desired output(s) to route the selected input to. This will highlight the output(s) with a green border to indicate the selection was made.

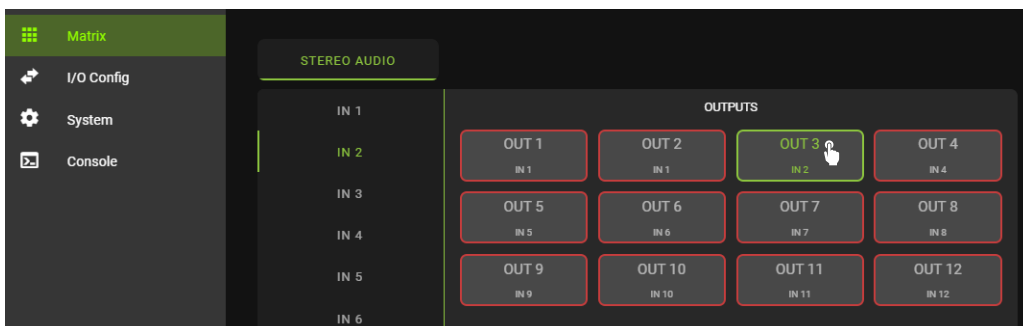

- 3 The selected input's audio signals are now routed to the selected output(s).

## I/O Config

The **I/O Config** tab page features tools and settings for configuring the audio inputs and outputs.

### Stereo Audio Input Settings

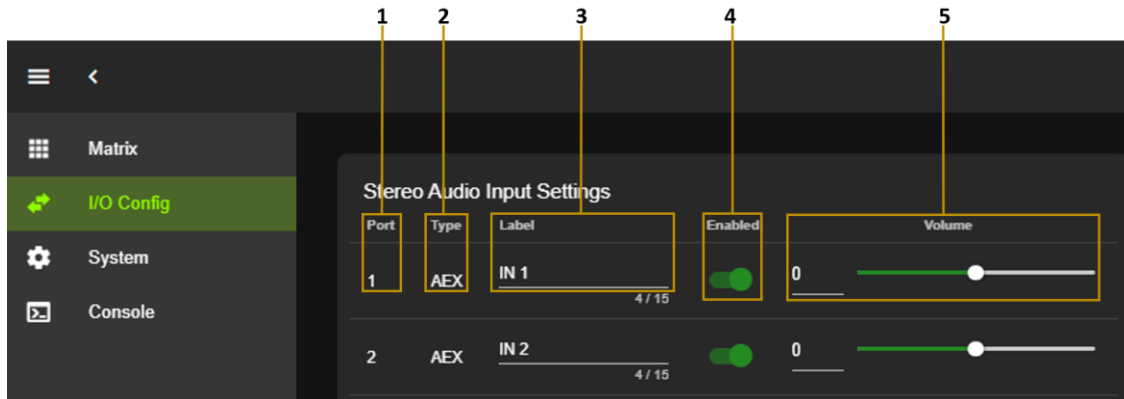

1	<b>Port</b>	Shows the audio input port number.
2	<b>Type</b>	Shows the audio input connection type.
3	<b>Label</b>	Select the text field to enter in a custom name for the input. <i>(Limit of 15 characters)</i>
4	<b>Enabled</b>	Select the toggle switch to enable or disable the audio input.
5	<b>Volume</b>	Adjust the volume by using the slider bar or entering a value (0~100) in the text field.

### Stereo Audio Output Settings



1	<b>Port</b>	Shows the audio output port number.
2	<b>Label</b>	Select the text field to enter in a custom name for the output. <i>(Limit of 15 characters)</i>
3	<b>Enabled</b>	Select the toggle switch to enable or disable the audio output.
4	<b>Muted</b>	Select the toggle switch to mute or unmute the audio output.
5	<b>Volume</b>	Adjust the volume by using the slider bar or entering a value (0~100) in the text field.
6	<b>Output Following</b>	Select the output following mode (source, volume, or both).
7	<b>EQ</b>	Select to view the outputs <i>Audio Configuration</i> settings.

## Output Following

This setting allows an output to mirror, or “follow”, the same operation as another output. It can also be used to create groups of outputs that will continually share the same input source, output volume level, or both. Changes to a followed output will automatically update any outputs when this setting is enabled.

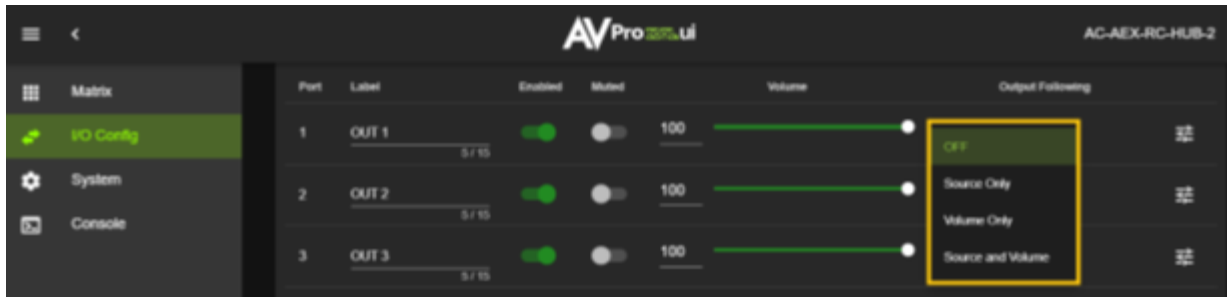

---

**Source Only** Matrix to the same input as the selected followed output.

---

**Volume Only** Set volume equivalent to the selected following output, including if the followed output is muted.

---

**Source and Volume** Matrix to the same input and set volume equivalent to the selected followed output.

---

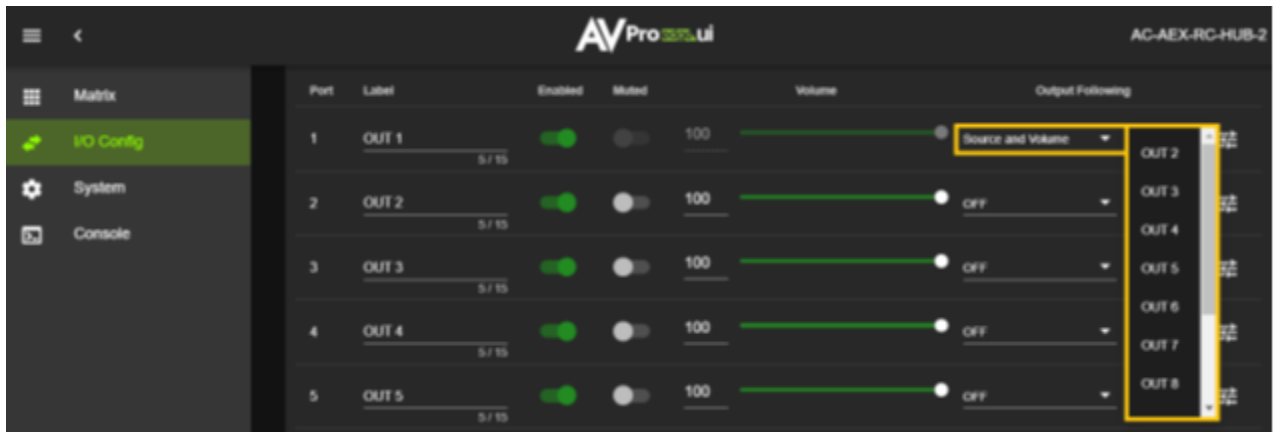

Once selected, an additional drop-down menu is provided to match the output it will follow.

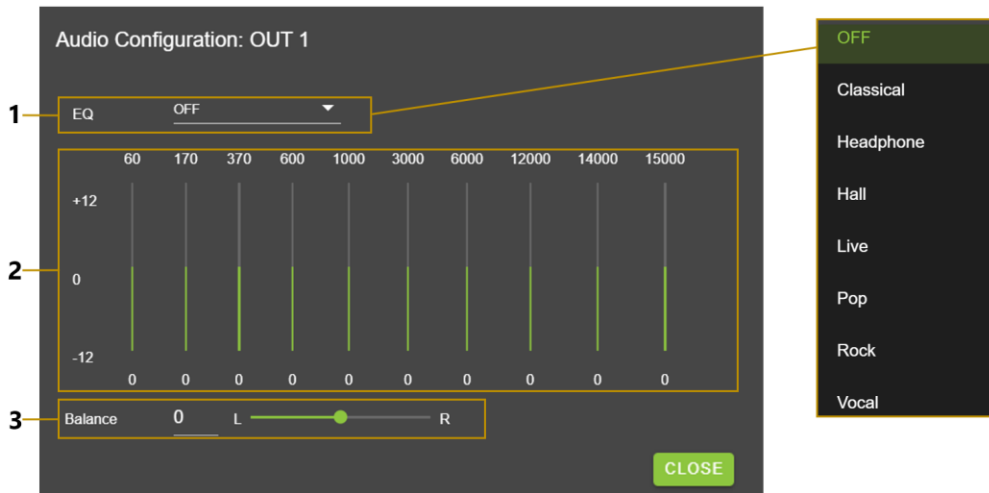

 **NOTE:** Once an output is set to follow another output, you will lose the ability to adjust either the input source or volume for that output until *Output Following* is disabled.

## Audio Configuration



- 
- |                    |   |
|--------------------|---|
| <b>1 EQ</b>        | Dropdown menu containing a list of 7 EQ presets. Selecting a preset adjusts the output's audio to a specific range of frequencies to improve sound quality.   |
| <hr/>              |   |
| <b>2 Frequency</b> | Graphic equalizer showing the individual frequency bands of the output's audio.   |
|                    |  <b>NOTE:</b> This graphic equalizer is only intended to be used as a visual reference of the individual audio frequency gains. Manual adjustments cannot be made to it. |
| <hr/>              |   |
| <b>3 Balance</b>   | Adjust the Left and Right volume by using the slider bar or entering a value (-10 to +10) in the text field.  |
|                    |  <b>NOTE:</b> -10 is balanced left, 0 is balanced, and +10 is balanced right.  |
-

# System

## IP Settings

These can be assigned by a DHCP reservation from the router when the *IP Assignment* is set to *Automatic*, or they can be manually entered in when the *IP Assignment* is set to *Manual*.

Select the *Apply* button when manually entering in the *IP Assignment*, *IP Address*, *Subnet Mask*, *Gateway*, *Primary DNS*, and *Secondary DNS* for changes to take effect.

1	<b>Host Name</b>	Select the text field to enter in a custom name for the unit. The default shows unit's model number.
2	<b>Model Name</b>	Shows the unit's AVPro Edge model number.
3	<b>Serial Number</b>	Shows the unit's unique serial number.
4	<b>MAC Address</b>	Shows the unit's unique MAC address.
5	<b>IP Assignment</b>	Select the dropdown menu to set the unit's IP mode to <i>DHCP</i> (default) or <i>Manual (Static IP)</i> , then select the <i>Apply</i> button.
6	<b>IP Address</b>	Shows the unit's IP address.
7	<b>Subnet Mask</b>	Shows the unit's subnet mask.
8	<b>Gateway</b>	Shows the unit's default gateway.
9	<b>Primary DNS</b>	Shows the unit's primary domain name server.
10	<b>Secondary DNS</b>	Shows the unit's secondary domain name server.

## IP Control

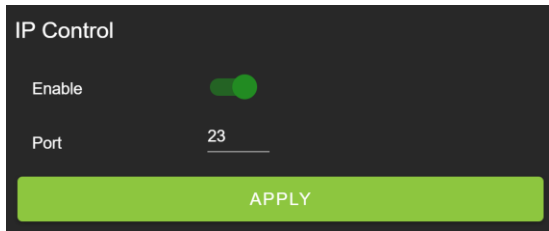

- |   |               |  |
|---|---------------|--|
| 2 | <b>Enable</b> | Select the toggle switch to enable or disable IP/TCP control.            |
| 3 | <b>Port</b>   | Select the text field to set the Telnet port. Default is Telnet port 23. |

## Admin Web Interface

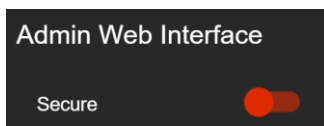

Select the *Secure* toggle switch to enable (green) or disable (red). When enabled, the username and password can be changed.

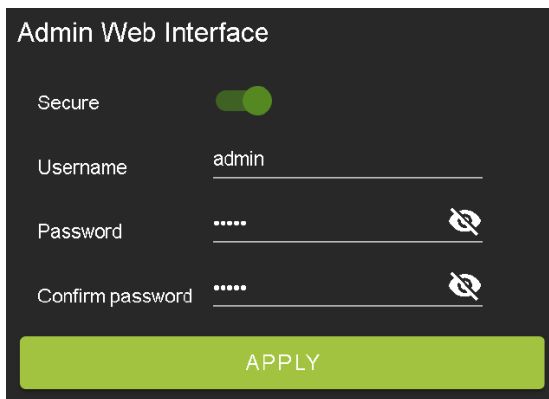

With the *Admin Web Interface* enabled, the only menu that will be accessible on the Web UI will be the **Matrix** tab page. The rest of the settings will require the *Admin* login.

Default username: *admin*

Default password: *admin*

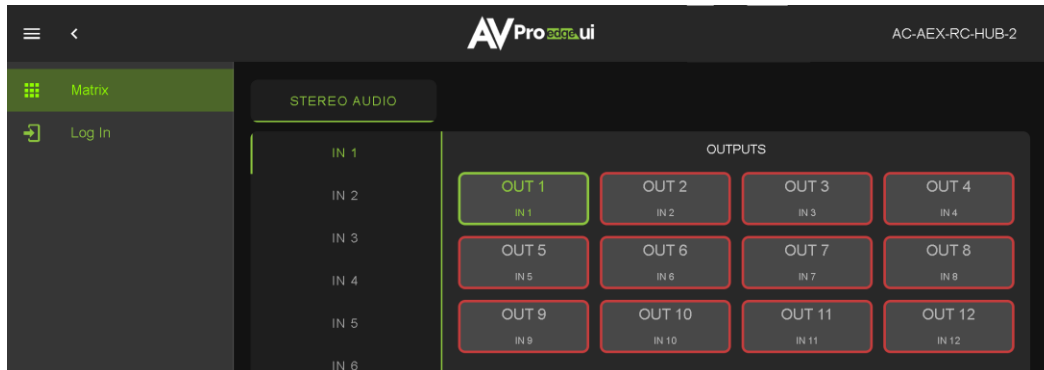

## User Web Interface

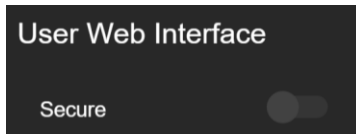

Select the *Secure* toggle switch to enable (green) or disable (grey). When enabled, the username and password can be changed.

 **NOTE:** The *Admin Web Interface* must first be enabled before this setting can be changed.

A dark-themed screenshot of the 'User Web Interface' configuration form. At the top, the title 'User Web Interface' is shown. Below it, there is a 'Secure' label with a green toggle switch in the 'on' position. Underneath, there are three input fields: 'Username' with the text 'user', 'Password' with masked characters '.....' and a visibility icon, and 'Confirm password' with masked characters '.....' and a visibility icon. At the bottom of the form is a large green button labeled 'APPLY'.

With the *Admin* and *User Web Interfaces* enabled, no menus will be accessible on the Web UI without first logging in.

Logging in with the *User* credentials, the only the menu that will be accessible on the Web UI will be the **Matrix** tab page. The rest of the settings will require the *Admin* login.

Default username: *user*

Default password: *user123*

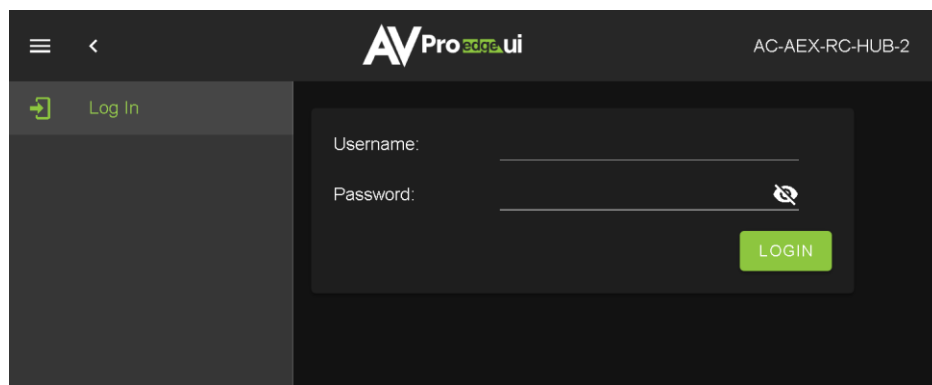

## Cloud Services

*Cloud Services* allows OTA (Over-the-Air) firmware updates to be performed onto the unit. This allows the unit to search the Cloud for the latest versions of firmware, as well as enable third-party remote management services. If *Cloud Services* are disabled, the unit will opt out of any previously enabled services and will not be able to access OTA firmware updates.



### NOTE:

When updating firmware, some settings and configurations may revert back to their original factory default settings and may need to be re-applied after the firmware updates are complete. It is always recommended to backup and save your settings and configurations before updating firmware.

- 1 Review the *Privacy Policy* and *Terms of Use*, then select both check boxes and select the *Enable Cloud Services* toggle setting.

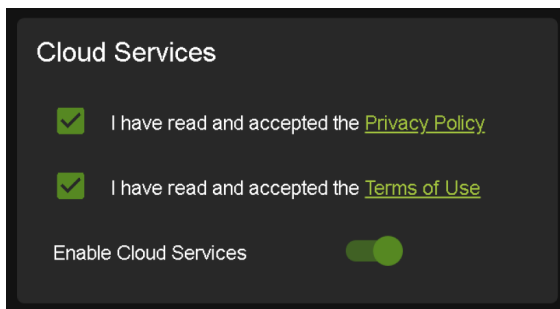

### IMPORTANT:

This is a required step in order for the unit to perform OTA firmware updates.

- 2 If the unit is already installed with the latest version of firmware, a notification window will prompt the message "No update available!" at the top of the page.



- 3 If a newer version of firmware is detected from the Cloud, a notification window will prompt the message "New firmware update is available!". Select the *Update* button.



- 4 The unit's new firmware file will automatically populate into the *File input* field from the Cloud. Select the *Upload* button.

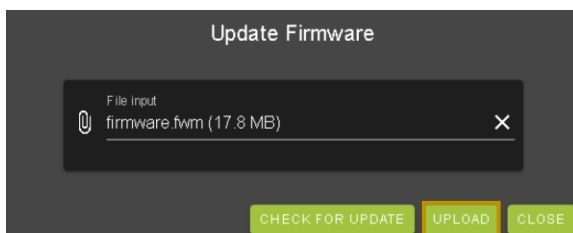



- From this screen, newer versions of firmware can be viewed before they are installed. Select the *Upgrade* button. The unit will now begin installing the latest versions of firmware. DO NOT refresh the webpage or power off the unit during the update.

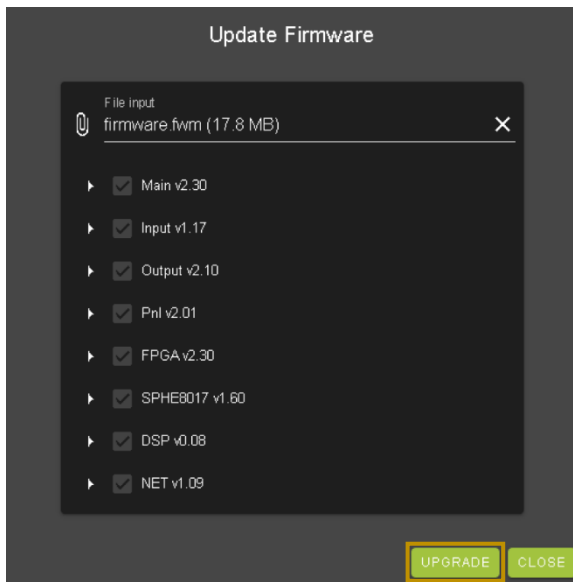

- Once the progress bar reaches 100%, select the *Close* button and refresh the webpage.
- The unit will automatically reboot once the firmware updates are complete. After the unit reboots, refresh the webpage to verify that the firmware update was successful.

## Hardware

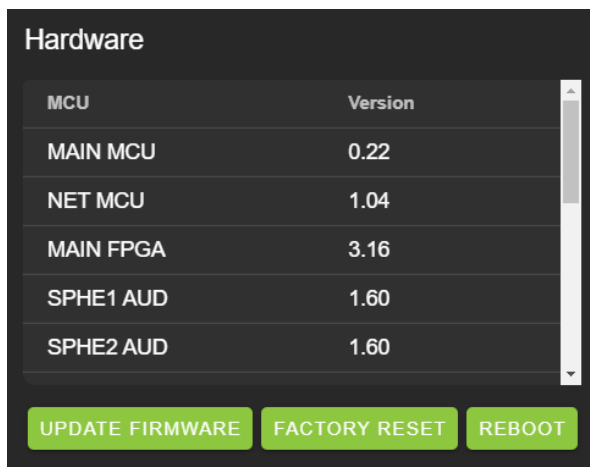

This section shows the unit's current firmware versions and provides options for updating firmware, factory resetting the unit, and rebooting the unit.

## Console

The Web UI features a built-in command console that allows API commands to be sent directly to the unit.

### Command List

Command	Action
H	Help
STA	Show global system status
SET RST	Reset to factory defaults
SET RBT	System reset to reboot
SET LAN RBT	Set LAN MCU reset to reboot
SET ADDR xx	Set System Address to xx {xx=[00-99](00=single)}
SET BAUDR x	Set System Baudrate to x {x=[0~5] (0=9600, 1=14400, 2=19200, 3=38400, 4=57600, 5=115200)}
GET ADDR	Get System Address
GET STA	Get System Status
GET CONFIG	Get System Configuration
GET BAUDR	Get System Baudrate
Input Setup Commands	
SET INx EN/DIS	Set Audio Input Enable/Disable {x=[0-12](0=all)}
SET INx VOLy	Set Audio Input Volume Adjustment {x=[0-12](0=all), y=-50~+50}
GET INx EN	Get Audio Input Enable/Disable {x=[0~12](0=all)}
GET INx VOL	Get Audio Input Volume Adjustment {x=[0~12](0=all)}
GET INx SIG STA	Get Input x Signal Status {x=[0~12](0=all)}
Output Setup Commands	
SET OUTx EN/DIS	Set Audio Output Enable/Disable {x=[0~12](0=all)}
SET OUTx AS IN y	Set Audio Output x to Input y {x=[0~12](0=all), y=[1~12]}
SET OUTx FOLLOW y OUTz	Set Audio Output x follow settings {x=[0~12](0=all[excluding self])} Follow Modes 0=None, 1=Source, 2=Volume, 3=Source+Volume If Follow Mode ! 0, then OUTz is the output that will be followed
SET OUTx MUTE/UNMUTE	Set Audio Output Mute/Unmute {x=[1~12](0=all)}
SET OUTx VOL y	Set Output x EQ-Audio Volume Level y {x=[0~12](0=all), y=[0~100]}
SET OUTx VOL + y	Increase Output x Volume by y {x=[1~12], y=[1~100, optional default 1]}
SET OUTx VOL - y	Decrease Output x Volume by y {x=[1~12], y=[1~100, optional default 1]}
SET OUTx BAL + y	Increase Output x Balance by y {x=[1~12], y=[1~100, optional default 1]}
SET OUTx BAL - y	Decrease Output x Balance by y {x=[1~12], y=[1~100, optional default 1]}
SET OUTx EQ y	Set Output x Audio Volume EQ Mode y {x=[0~12](0=all), y=[0~7] (0=Off, 1=Classical, 2=Headphone, 3=Hall, 4=Live, 5=Pop, 6=Rock, 7=Vocal)}
GET OUTx EN	Get Audio Output Enable/Disable Status {x=[0~12](0=all)}
GET OUTx AS	Get Output x Audio Route {x=[0~12](0=all)}
GET OUTx FOLLOW	Get Audio Output x follow settings {x=[0~12](0=all[excluding self])} Follow Modes 0=None, 1=Source, 2=Volume, 3=Source+Volume If Follow Mode ! 0, then OUTz is the output that will be followed

GET OUTx MUTE	Get Audio Output Mute/Unmute {x=[0~12](0=all)}
GET OUTx VOL	Get Output x EQ-Audio Volume Level {x=[0~12](0=all)}
GET OUTx EQ	Get Output x Audio Volume EQ Mode Status {x=[0~12](0=all)}
GET OUTx BAL	Get Output x Balance {x=[0~12](0=all), y=[0~20, Left=0, Right=20, Balanced=10]}

### Network Setup Commands

SET RIP xxx.xxx.xxx.xxx	Set Route IP Address to xxx.xxx.xxx.xxx (xxx=[000~255])
SET HIP xxx.xxx.xxx.xxx	Set Host IP Address to xxx.xxx.xxx.xxx (xxx=[000~255])
SET NMK xxx.xxx.xxx.xxx	Set Net Mask to xxx.xxx.xxx.xxx (xxx=[000~255])
SET TIP zzzz	Set TCP/IP Port to zzzz (zzzz=[0001~9999])
SET DHCP y	Set DHCP {y=[0~1](0=Dis,1=Enable)}
GET RIP	Get Route IP Address
GET HIP	Get Host IP Address
GET NMK	Get Net Mask
GET TIP	Get TCP/IP Port
GET DHCP	Get DHCP Status
GET MAC	Get MAC Address

## TROUBLESHOOTING

- Verify Power - Check that the power supply is properly connected and on an active circuit. Press the OK button on the front panel, this should illuminate the Input/Output LEDs.
- Verify Connections - Check that all cables are connected securely and properly terminated where applicable.
- Verify the unit has the latest available firmware. See page(s) 24 and 25 Cloud Services for more information.
- Good Indicator Lights, but No Sound – Verify signal is being sent from the audio source and signal format is compatible with devices in the signal chain. Ensure the input audio source is matrixed to the correct audio output, input and output is enabled, output is set to an audible volume level and not muted.
- Static, Buzzing, or Humming Noises – Use shielded RCA cabling between the AC-AEX-RC-HUB and the connected analog devices to maintain a high level of audio performance. Ground the matrix to the conducting parts (equipment rack, mounting devices, truss systems, electrical switchboards, metal electrical conduits, etc.). This technique ensures all the equipment in an electrical system will use the same reference value for their signals and reduces the possibility of a ground loop, which can result in a shift in video signals and main frequencies to exhibit a buzzing or humming noise in audio systems.

## MAINTENANCE

To ensure reliable operation of this product as well as protecting the safety of any person using or

- handling this device while powered, please observe the following instructions.
- Use the power supplies provided. If an alternate supply is required, check voltage, polarity and that it has sufficient power to supply the device it is connected to.
- Do not operate these products outside the specified temperature and humidity range given in the above specifications.
- Ensure there is adequate ventilation to allow this product to operate efficiently.
- Repair of the equipment should only be carried out by qualified professionals as these products contain sensitive components that may be damaged by any mistreatment.
- Only use this product in a dry environment. Do not allow any liquids or harmful chemicals to come into contact with these products.
- Clean this unit with a soft, dry cloth. Never use alcohol, paint thinner or benzene to clean this unit.

## DAMAGE REQUIRING SERVICE

The unit should be serviced by qualified service personnel if:

- The DC power supply cord or AC adapter has been damaged

- Objects or liquids have gotten into the unit
- The unit has been exposed to rain
- The unit does not operate normally or exhibits a marked change in performance
- The unit has been dropped or the housing damaged

## SUPPORT

Should you experience any problems while using this product, first, refer to the Troubleshooting section of this manual before contacting Technical Support. When calling, the following information should be provided:

- Product name and model number
- Product serial number
- Details of the issue and any conditions under which the issue is occurring
- Clean this unit with a soft, dry cloth. Never use alcohol, paint thinner or benzene to clean this unit.

## WARRANTY

### The Basics

AVPro Edge warrants its products that are purchased from all Authorized AVPro Edge Resellers or direct purchases. Products are guaranteed to be free from manufacturing defects and of sound physical and electronic condition.

AVPro Edge has developed a warranty that anyone can get behind. We really wanted to take all the “red tape” out of a warranty and just make it simple. Our 10 YEAR NO BS warranty hinges on 3 elements.

- If you are having trouble, call us. We will attempt to troubleshoot your issue over the phone.
- If it's broken, we will replace it in advance on our dime and we'll also cover the return shipping. Repair is an option too, but it's YOUR call.
- We know you know what you are doing. We will not make you go through unnecessary steps to troubleshoot an extender...

### Coverage Details

AVPro Edge will replace or repair (at customer choice) the defective product. If the product is out of stock or on back order it can either be replaced with a comparable product of equal value/feature set (if available) or repair.

Your warranty begins at receipt of product (as confirmed by shipping firm tracking). If tracking information is unavailable for any reason, the warranty will commence 30 ARO (After Receipt of Order). The coverage continues for 10 years.

### Red Tape

AVPro Edge is not responsible for untraceable purchases or those that were made outside of an authorized channel.

If we conclude that a product or serial number has been tampered with as identified by warranty seal or physical examination the warranty will be void. Additionally, excessive physical damage (beyond normal wear & tear) the warranty may be voided or prorated based on the extent of the damage as examined by an AVPro Edge representative.

Damage caused by "acts of God" are not covered. They can include natural disasters, power surges, storms, earthquakes,

tornadoes, sink holes, typhoons, tidal waves, hurricanes, or any other uncontrollable event related to nature.

Damage caused by incorrect installation will not be covered. Incorrect power supply, inadequate cooling, improper cabling, inadequate protection, static discharge are examples of this.

Products installed or sold by a third party to AVPro Edge will be serviced by the Authorized AVPro Edge Reseller. Accessories (IR Cables, RS-232, Power Supplies, etc.) are not included in the warranty. We will make acceptable effort to source and supply replacements for defective accessories at a discounted rate as needed.

## **Obtaining an RMA**

Dealers, Re-sellers, and Installers can request an RMA from AVPro Edge Tech Support Rep or their Sales Engineer. Or you may email [support@avproedge.com](mailto:support@avproedge.com) or fill out the general contact form at [www.avproedge.com/contact](http://www.avproedge.com/contact)

End users may not request and RMA directly from AVPro Edge and will be referred back to the Dealer, Re-seller, or Installer.

## **Shipping**

For USA (not including Alaska and Hawaii). Shipping is covered on advanced replacements for FedEx Ground (some expressed exceptions may apply). Defective product return shipping is covered by AVPro Edge using an emailed return label. Item must be returned within 30 days of receipt of replacement product, after 30 days, the customer will be billed. Other return shipping methods will not be covered.

For International (and Alaska and Hawaii) return shipping costs will be the responsibility of the returnee. Once the unit is scanned for return shipping AVPro Edge will ship new unit for replacement.

## **Limitation on Liability**

The maximum liability of AVPro Global Holdings LLC under this limited warranty shall not exceed the actual purchase price paid for the product. AVPro Global Holdings LLC is not responsible for direct, special, incidental, or consequential damages resulting from any breach of warranty or condition, or under any other legal theory to the maximum extent permitted by law. Taxes, Duties, VAT, and freight forwarding service charges are not covered or paid for by this warranty.

Obsolescence or incompatibility with newly invented technologies (after manufacture of product) is not covered by this warranty. Obsolescence is defined as:

"Peripherals are rendered obsolete when current technology does not support product repair or re-manufacture. Obsolete products cannot be re-manufactured because advanced technologies supersede

original product manufacturer capabilities. Because of performance, price and functionality issues, product redevelopment is not an option.”

Discontinued or out of production items will be credited at fair market value towards a current product of equal or comparable capabilities and cost. Fair market value is determined by AVPro Edge.

### **Exclusive Remedy**

To the maximum extent permitted by law, this limited warranty and the remedies set forth above are exclusive and in lieu of all other warranties, remedies, and conditions, whether oral or written, express or implied. To the maximum extent permitted by law, AVPro Global Holdings LLC specifically disclaims any and all implied warranties, including, without limitation, warranties of merchantability and fitness for a particular purpose. If AVPro Global Holdings LLC cannot lawfully disclaim or exclude implied warranties under applicable law, then all implied warranties covering this product, including warranties of merchantability and fitness for a particular purpose, shall apply to this product as provided under applicable law. This warranty supersedes all other warranties, remedies, and conditions, whether oral or written, express or implied.