

User Manual

8K 8×8 Matrix with Ultrawide, 40Gbps Bandwidth Input and Output Stages

AC-MX-88X



INTRODUCTION4

FEATURES4

WHATS IN THE BOX4

SPECIFICATIONS5

FRONT AND REAR PANEL OVERVIEW6

INITIAL SETUP: WEBUI7

ADVANCED SETUP: WEBUI INPUT SETTINGS - EDID 10

ADVANCED SETUP: GLOBAL INPUT SETTINGS 11

ADVANCED SETUP: WEBUI VIDEO OUTPUT SETTINGS 11

ADVANCED SETUP: WEBUI EXTRACTED AUDIO OUTPUT SETTINGS 12

WEBUI: VIDEO MATRIX 15

WEBUI: AUDIO MATRIX 16

WEBUI: I/O CONFIG - INPUT SETTINGS 17

WEBUI: I/O CONFIG - INPUT SETTINGS CONT 18

WEBUI: I/O CONFIG - OUTPUT SETTINGS 19

WEBUI: I/O CONFIG - OUTPUT SETTINGS CONT 19

WEBUI: I/O CONFIG - OUTPUT SETTINGS CONT 20

WEBUI: I/O CONFIG - OUTPUT SETTINGS CONT 21

WEBUI: SYSTEM - IP SETTINGS 22

WEBUI: SYSTEM - TELNET SETTINGS 23

WEBUI: SYSTEM - ADMIN WEB INTERFACE 23

WEBUI: SYSTEM - USER WEB INTERFACE 24

WEBUI: SYSTEM - CLOUD SERVICES 25

WEBUI: SYSTEM - FIRMWARE UPDATE CONT 26

WEBUI: SYSTEM - HARDWARE 26

WEBUI: DIAGNOSTICS - HDMI IN 27

WEBUI: DIAGNOSTICS - HDMI IN CONT..... 28

WEBUI: DIAGNOSTICS - HDMI OUT 29

WEBUI: CONSOLE 30

FRONT PANEL CONTROL - SWITCHING 31

FRONT PANEL CONTROL - EDID 32

FRONT PANEL CONTROL - AUDIO 33

FRONT PANEL CONTROL - NETWORK 33

IR CONTROL: IR REMOTE 34

IR CONTROL: EXTENSION PORT 34

RS-232 AND TCP/IP CONTROL 35

COMMAND LIST 36

COMMAND LIST CONTINUED: 37

COMMAND LIST CONTINUED: 38

EXTRACTED AUDIO 39

BALANCED 5 PIN 2CH AND TOSLINK AUDIO PORT /SPDIF39V

AUDIO OUTPUT LOGIC AND CABLE PREP 40

TROUBLESHOOTING 41

BANDWIDTH CHART 42

BANDWIDTH CHART CONTINUED 43

MAINTENANCE 44

DAMAGE REQUIRING SERVICE 44

SUPPORT 45

WARRANTY 45

Introduction

Simply stated, the AVPro Edge AC-MX-88X is a classic transformed into an icon. Our engineers focused on re-imagining the venerable AC-MX-88, boosting bandwidth to an ultrawide 40Gbps with 8K input and output stages, for a world-first, Next-Gen 8 input / 8 output matrix switching platform providing a foundation for all possibilities that follow. "X" marks the spot for high performance that is unmistakably AVPro Edge, as we once again redefine the face of the HDMI switching era. Gaming enthusiasts, rejoice - multiple inputs for multiple consoles! Select Xbox Series X, PlayStation 5, or your Alienware Aurora Ryzen by control system or from the supplied IR remote and leave the cable juggling to Cirque du Soleil.

The AC-MX-88X, designed with the needs of Next-Gen users in mind, prepares your clients for tomorrow's over-the-horizon signals, while ultrawide bandwidth supplies sure-footed dynamic headroom for hiccup-free performance with HDMI 2.1a devices. With the unmatched pedigree of AVPro Edge behind it tradition never fails, as the AC-MX-88X lets you break convention and seek perfection.

Features

- HDMI Specification HDMI 2.1a
- HDCP 2.3 (and all earlier versions supported)
- Up to 8K 60Hz 4:2:0 / 8K 30 Hz 4:4:4, 60-120fps
- 4K 120Hz, 120fps
- 8K to 4K or 8K/4K to 1080p Down Scaling on all outputs
- Balanced Analog Audio Outputs (2 CH PCM)
- Full HDR Support (HDR 10 & 12 Bit)
- Dolby Vision, HDR10+ and HLG Support
- Advanced EDID Management
- IR, RS-232 and LAN Control Option
- Driver Support for C4, Crestron, Elan, RTI, Savant, URC and more
- NOTE: 8K Ultra-wide Bandwidth Necessitates the Use of Active Optical Cables for Distances Over 4 Meters. Please see Bullet Train Cables for Length Options.

Whats in the box

- 1x AC-MX-88X (Matrix Switch)
- 1x 48V 3.75A Power Supply
- 1x IR Remote Control
- 1x CR2025 Battery for IR Remote
- 1x IR Extension Cable
- 8x 5pin Terminal to L/R adapter cables for 2ch Extracted Audio
- 1x 3pin terminal block (for RS-232)
- 2x Mounting Brackets (Installed)
- 1x Ground strap
- 4x Matrix Feet with hardware



*3V CR2025 Battery Required For IR Remote Control
1x Included in the packaging.



Specifications

VIDEO:	
VIDEO RESOLUTIONS	UP TO 8K 60Hz 4:2:0/8K 30Hz 4:4:4/4K 120Hz
HDR FORMATS/RESOLUTIONS	420, 422, 444 (10 AND 12 DEEP COLOR) HDR10, HDR10+, DOLBY VISION, HLG
COLOR SPACE	YUV (COMPONENT), RGB (CSC: REC. 601, REC. 709, BT2020, DCI, P3 D6500)
CHROMA SUBSAMPLING	4:4:4, 4:2:2, & 4:2:0 SUPPORTED
DEEP COLOR	UP TO 16 BIT
SCALING (AVAILABLE ON ALL OUTPUTS)	8K TO 4K OR 8K/4K TO 1080P
ADDITIONAL HDMI 2.1 FEATURES	ALLM, VRR, QMS, QFT, HFR
AUDIO:	
AUDIO FORMATS SUPPORTED HDMI	LPCM UP TO 7.1 192 KHz 24BIT, DOLBY DIGITAL, DOLBY DIGITAL PLUS, DOLBY MAT, DOLBY TRUEHD, DOLBY ATMOS (ALL FORMATS), DOLBY AC-4, DTS DIGITAL, DTS DISCRETE, DTS EXPRESS, DTS HIRES AUDIO, DTS MASTER AUDIO, DTS:X
AUDIO FORMATS SUPPORTED EXTRACTED (TOSLINK)	LPCM UP TO 5.1 96KHz 24 BIT, DOLBY DIGITAL 5.1, DTS HIRES AUDIO
AUDIO FORMATS SUPPORTED EXTRACTED (2CH PORT)	PCM 2 CH
AUDIO EXTRACTION LOCATION	BIND TO INPUT, BIND TO OUTPUT OR MATRIX (INDEPENDENT)
AUDIO DELAY (PER OUTPUT, EXTRACTED)	UP TO 630ms
DISTANCE: WITH HDMI 2.0 SIGNALS (UP TO 18Gbps - TMDS)	
PASSIVE HDMI IN/OUT	UP TO 10 METERS/32.8 FEET
AOC HDMI IN/OUT	UP TO 100 METERS/328 FEET
DISTANCE: WITH HDMI 2.1 SIGNALS (UP TO 40Gbps - FRL)	
PASSIVE HDMI IN/OUT	UP TO 4 METERS/13.1 FEET
AOC HDMI IN/OUT	UP TO 100 METERS/328 FEET
OTHER:	
BANDWIDTH	40Gbps (FRL 5)
HDCP	1.4, 2.X SUPPORT
CONTROL:	
PORTS	LAN, RS232, IR WINDOW
DRIVERS	C4, RTI, ELAN, CRESTRON, URC (FOR MORE INFORMATION - SEE DRIVERS PAGE ON AVPROEDGE.COM/DRIVERS)
AVPRO WEbUI	YES
PORTS:	
HDMI	TYPE A
LAN	RJ45 W/ WEB INTERFACE/ CONTROL
AUDIO (EXTRACTED DIGITAL)	TOSLINK
AUDIO (EXTRACTED ANALOG)	L/R AUDIO
IR RX	WINDOW ONLY (REMOTE INCLUDED)
RS232	3 PIN TERMINAL BLOCK
ENVIRONMENTAL:	
OPERATING TEMPERATURE	23 TO 125°F (-5 TO 51°C)
STORAGE TEMPERATURE	-4 TO 140°F (-20 TO 60°C)
HUMIDITY RANGE	5-90% RH (NO CONDENSATION)
POWER:	
POWER CONSUMPTION (TOTAL)	90 WATTS MAX
POWER SUPPLY - MATRIX	INPUT: AC 100-240V ~ 50/60HZ OUTPUT: DC 48V 3.75A
DIMENSIONS:	
DIMENSIONS (UNIT ONLY - HEIGHT/DEPTH/WIDTH)	MM: 44 X 260.35 X 441.45 INCH: 1.73 X 10.25 X 17.38
DIMENSIONS (PACKAGED HEIGHT/DEPTH/WIDTH)	MM: 88.9 X 444.5 X 495.3 INCH: 3.5 X 17.5 X 19.5
WEIGHT (UNIT)	8.8 LBS (4 KG)
WEIGHT (PACKAGED)	12.8 LBS (5.8 KG)
*SPECIFICATIONS SUBJECT TO CHANGE WITHOUT NOTICE. MASS & DIMENSIONS ARE APPROXIMATE	

Front and Rear Panel Overview

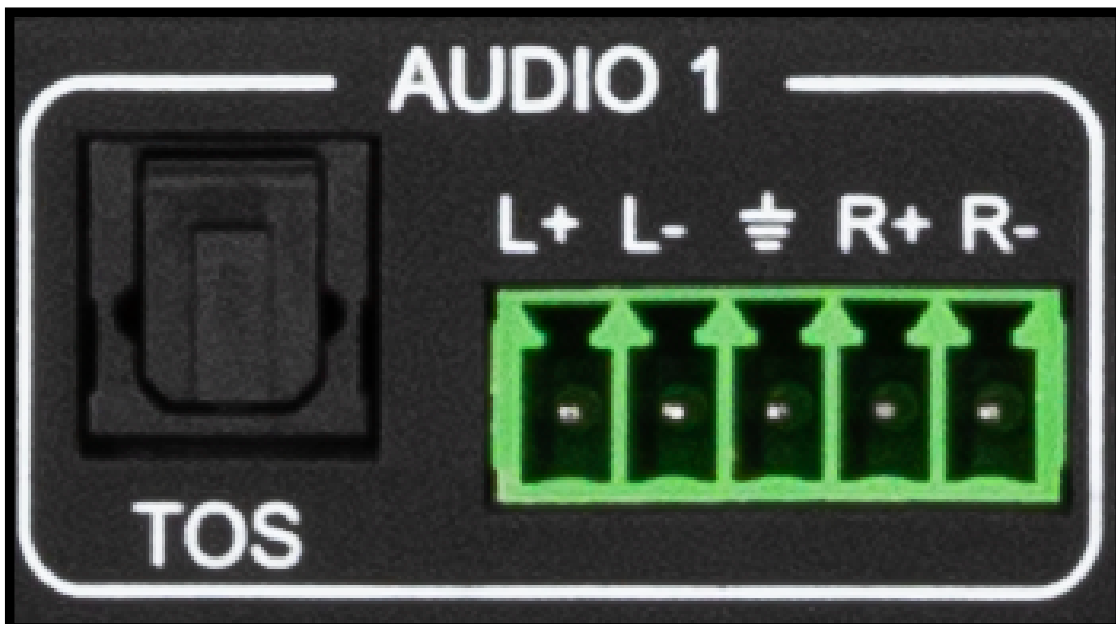
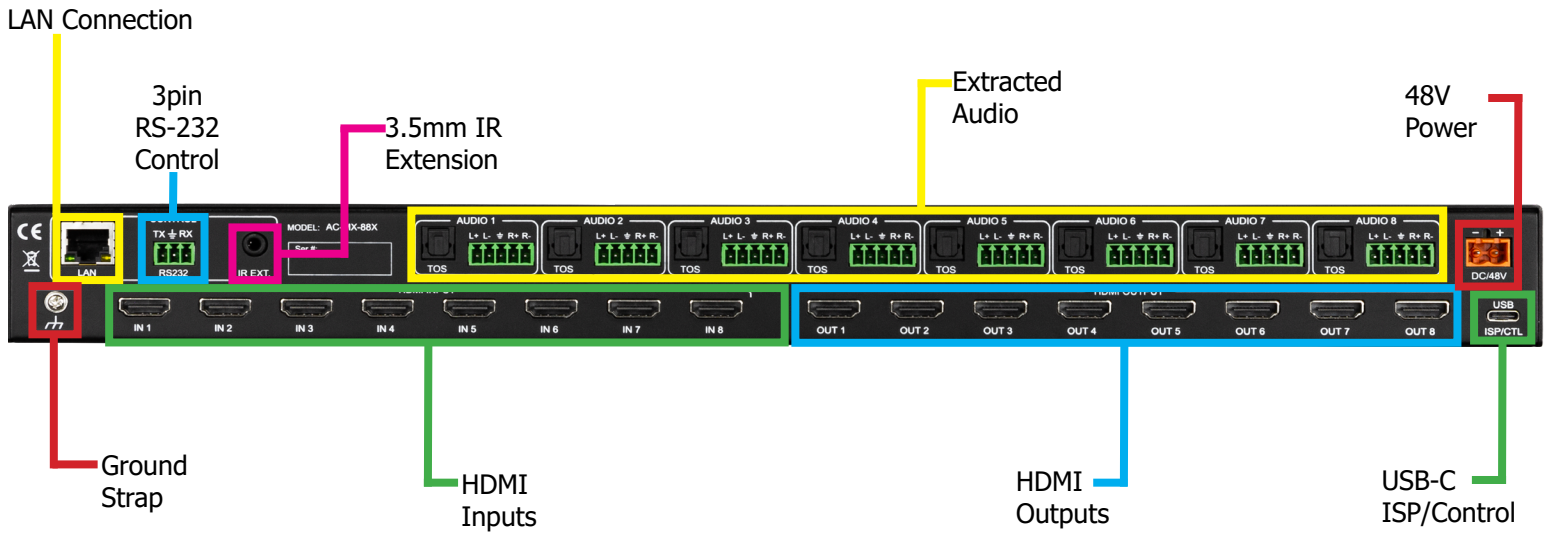
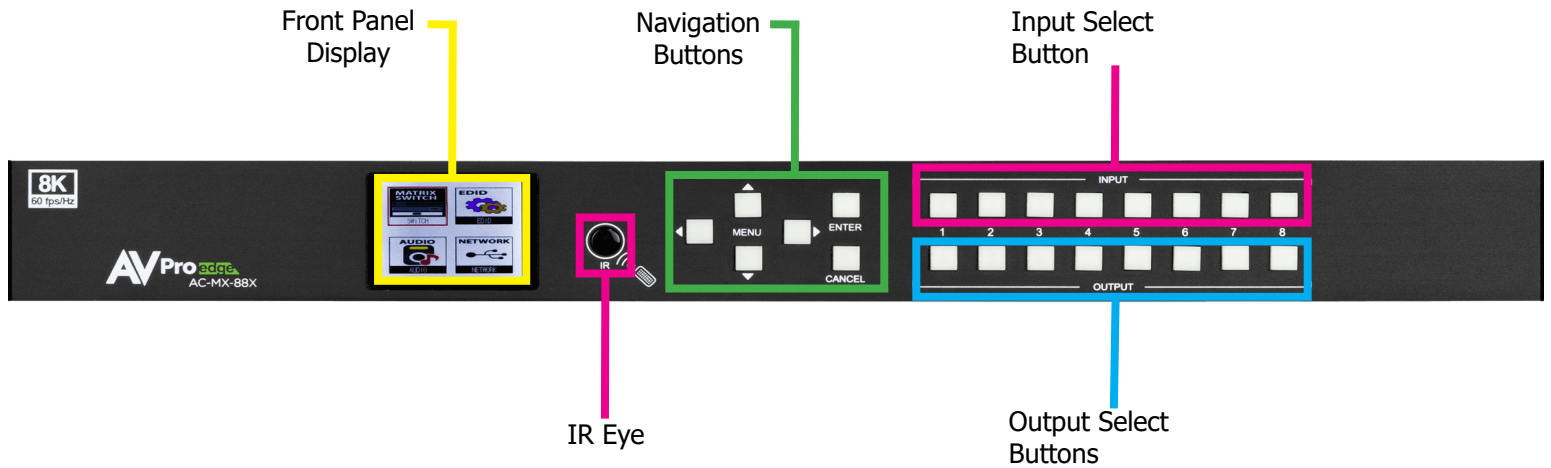

Initial Setup: WebUI

The AC-MX-88X can be controlled using the USB-C port, 3pin RS232, or over TCP/IP using the LAN connection. For initial setup it is recommended to connect the matrix to a local area network (LAN) and use a computer on the same network in conjunction with the built in WebUI. After making all the physical connections, the first step will be to check for any Firmware Updates. The below steps are an example of this setup, other control options are covered in separate sections of this user manual.

1. With the AC-MX-88X placed into its new home (AV Rack, cabinet, table top) take a Phillips head screwdriver and attach the included yellow ground strap to the back of the chassis using the pre-installed screw, then attach the other end to a suitable grounded object.



2. Connect the HDMI Input sources to the HDMI Inputs on the back of the matrix.
3. Connect the HDMI/devices to the HDMI Outputs.
4. Connect the network LAN cable to the RJ45 port labeled LAN (next to 3pin RS232 port above grounding screw).
5. Power on the sources (Inputs).
6. Power on the Output devices/displays.
7. Connect the 48V power supply to power on the matrix and then to a suitable power source.
8. Using the front panel display and Menu navigation buttons navigate to NETWORK and press the ENTER button to enter the IP Settings menu.

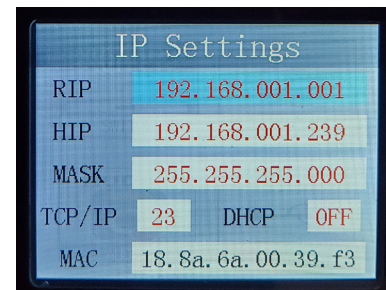
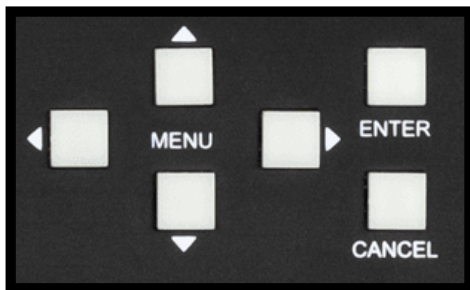

9. Either manually enter in your desired IP settings, or enable DHCP and let your network assign the correct settings. Use the UP/DOWN arrow keys to highlight the row you want to change (HIP, RIP, TCP Port, etc), click , use left/right arrow keys to select and the UP/DOWN arrow keys to change the setting. Click the OK button again to confirm those changes.
10. With the matrix connected to the local network, using a computer on the same network open up a web browser and type the HIP (Host IP Address) into the address bar to navigate to the WebUI.

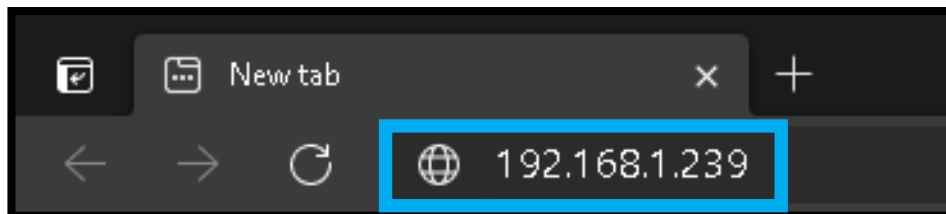

11. With the AVProEdge WebUI open, navigate to System. Click on the **Privacy Policy** and **Terms of Use**, this will open these documents in a new tab for review. Once read click on the boxes next to each to agree. When both are checked the switch for Enable Cloud Services will be selectable (will be red or disabled by default). Click to enable (the switch will turn green).

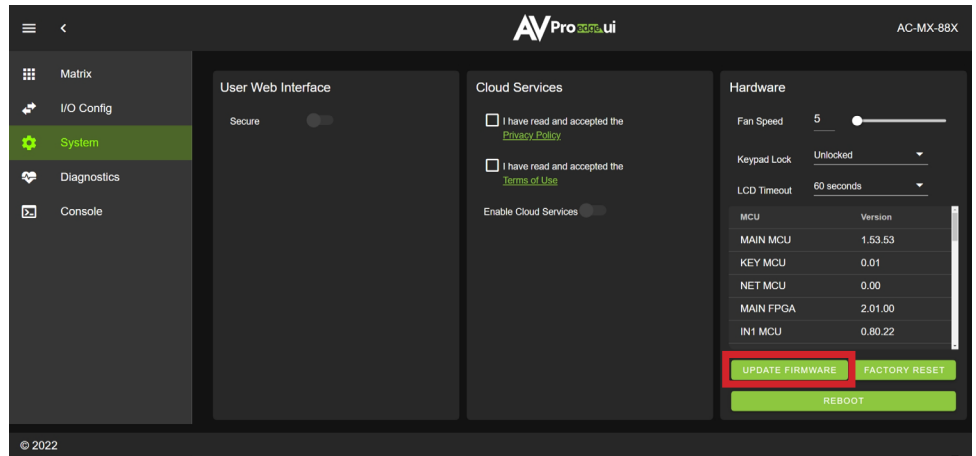
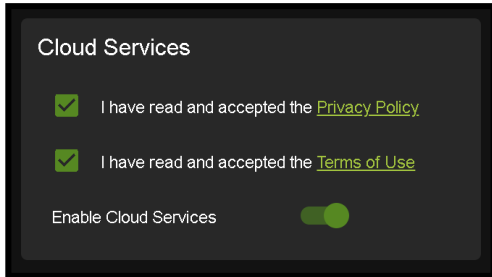
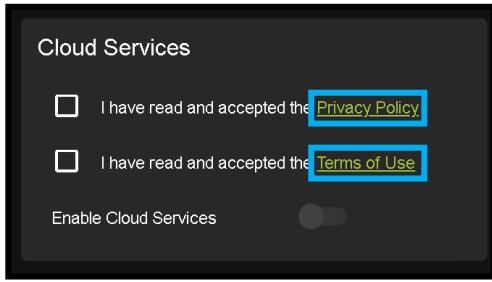

12. With the Cloud Services enabled under the Hardware section click the **Update Firmware** button to check for new Firmware OTA (over the air). This will compare the firmware versions currently loaded on the AC-AXION-X and compare to the latest available. If it is up to date, you will see a prompt stating "No update available!"



13. If an update is available, the following prompt will show. Simply click **UPDATE**.



14. If a new update is available a file will automatically be selected, simply click the **UPLOAD** button to load the firmware files to the Matrix. Uploading does not install the Firmware, that is the next step.

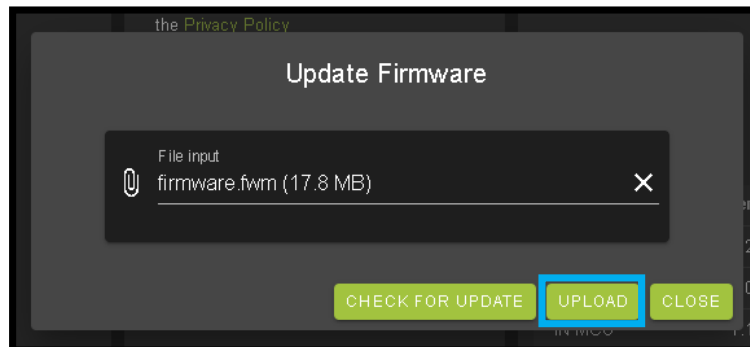

- Once the firmware file has been uploaded, it will display all containing firmware files. Here you can select individual firmware files to load or simply leave all files/options selected. If the version currently installed is not newer (does not need to be updated), then that update will be skipped automatically. Click the **UPGRADE** button to start.

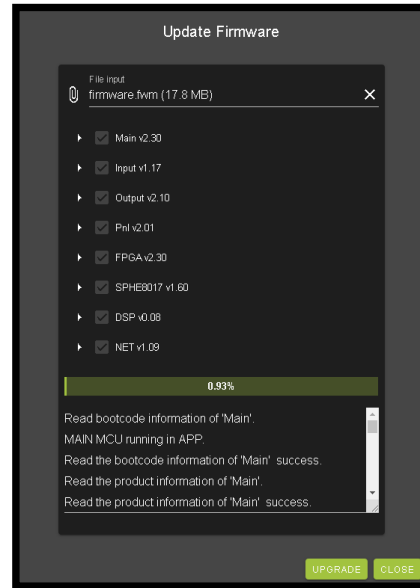
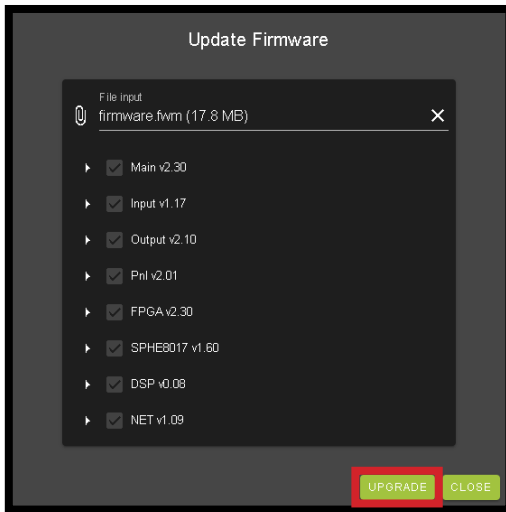

- Once the progress bar hits 100% click the CLOSE button, the firmware upgrade process is complete.
- With the Firmware up to date it's time to start setting up the matrix. With the AVProEdge WebUI open, navigate to the I/O Config section. Label the applicable Inputs (Apple TV, Cable Box, Roku, etc) under the **Input Settings - Label.**

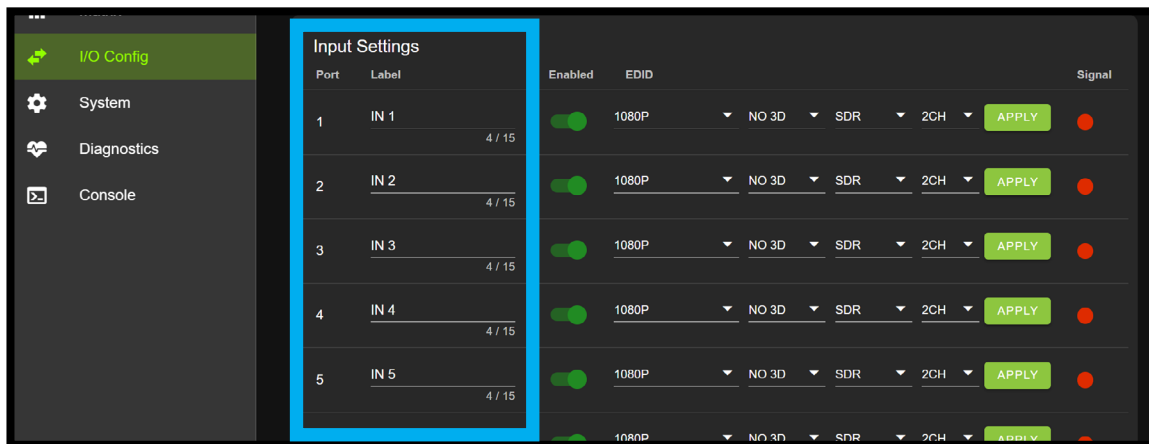

- If an Input is not being used, you can click the Enabled switch off (it will turn red).
- Label the Outputs (Living Room, Bedroom, Den, etc) under the Video Output Settings - Label.

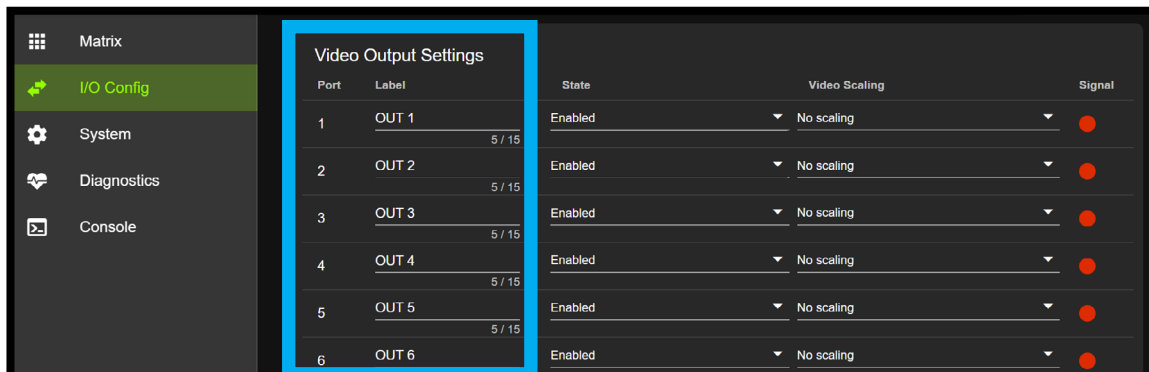

20. Set the HDMI Video Scaling if needed. Each HDMI OUTPUT has a drop-down with x3 options for scaling.

- No Scaling (default) - No scaling will be applied to that output.
- 4K to 1080P - Any signal above 1080P will be down-scaled to 1080P
- 8K to 4K - Any signal above 4K will be down-scaled to 4K

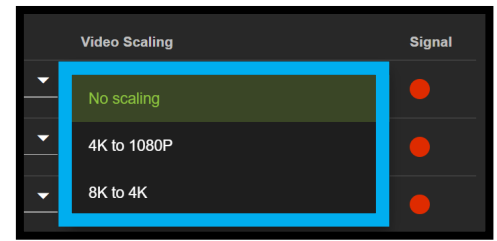

21. With the system and all its components powered up it's time to verify signal path from source to the sync. For now leave EDID settings to their default 1080P 2CH, the next section Advanced Setup will cover the more advanced settings.

22. Use the Signal Indicator on the HDMI INPUTS. Green means HDMI source is detected, red means that the source is not detected. If red verify that the input is powered on and that the HDMI cable is properly connected to the source and to the back of the matrix.



23. Now verify the connections to the HDMI outputs using the Signal indicator. Green means HDMI sync is detected, red means that the HDMI sync is not detected. If red verify that the sync devices are powered on and that the HDMI cables are properly connected to the back of the matrix.

24. With everything connected and powered on, green indicators across the applicable inputs and outputs, verify you are getting all of your sources on all of your displays.

25. Problems with a source or sync, see the Troubleshooting section for help on page[s] [41](#).

Advanced Setup: WebUI Input Settings - EDID

After verifying good signal path from source to sync now it is time to go through the rest of the settings to maximize the setup. Starting on the input side with the EDID.

1. With the WebUI open, navigate to the I/O Config tab and focus on the Input Settings section at the top.

2. Set the EDID on each input by selecting the resolution drop-down first (default is set to 1080P). The options are 1080P, 4K30Hz, 4K60Hz Y420, 4K60Hz, and FRL10G8K. If you select USER1 EDID, then the drop-downs change to allow you to select from an output to copy from. You can select any of the 8 HDMI outputs then click the COPY button. This will save that outputs EDID to the USER1 slot.

3. Next use the drop-down to select NO 3D, or 3D depending on the displays capability.

NOTE: Currently the only resolution you can choose NO 3D for is 1080P.

4. Next drop-down select either SDR (standard dynamic range) or HDR (High Dynamic Range).

5. The fourth drop-down in the EDID section is for the audio, you can select 2CH, 6CH, or 8CH.

6. Click the **APPLY** button to set the EDID.

7. Verify you are still getting that source to all your displays and that the image looks correct.

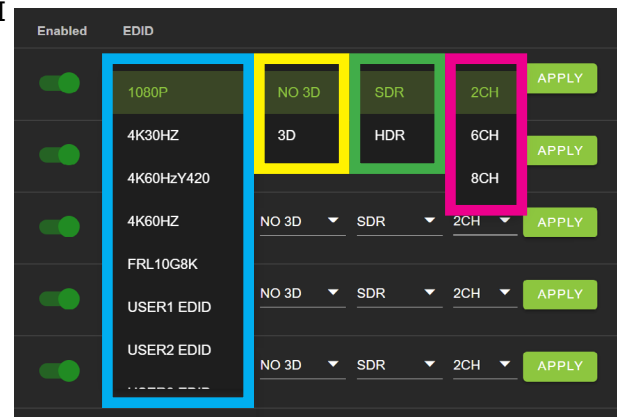

NOTE: Some older displays may take an HDR signal and display correctly (ignoring the HDR Metadata) others will not ignore the HDR part of the signal and may display incorrectly.

Advanced Setup: Global Input Settings

Under the Input settings is a section called Global Input Settings. These two settings apply to all eight of the HDMI Inputs. Default these are both off (unchecked) but depending on the system both of these may need to be checked for optimum performance. Check the specifications on the devices in the signal chain to verify compatibility/support.

- Support Dolby MAT - Check this box to enable Dolby MAT audio.
- Require Dolby Vision Low Latency - Check this box to require Dolby Vision Low Latency (Player-led) over Standard Dolby Vision (TV-Led). Sources like the Apple TV and X-Box Series X use Dolby Vision Low Latency.

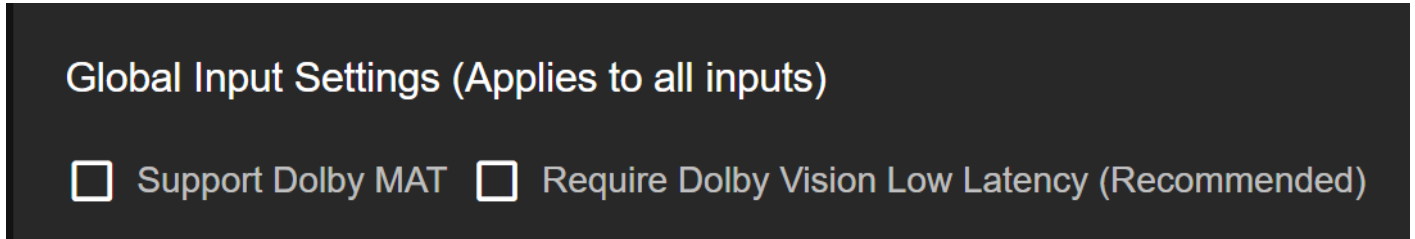

Advanced Setup: WebUI Video Output Settings

1. Now navigate to the Video Output Settings under I/O Config
2. In addition to the output Label (name/alias), there State and Video Scaling Settings for each HDMI output.

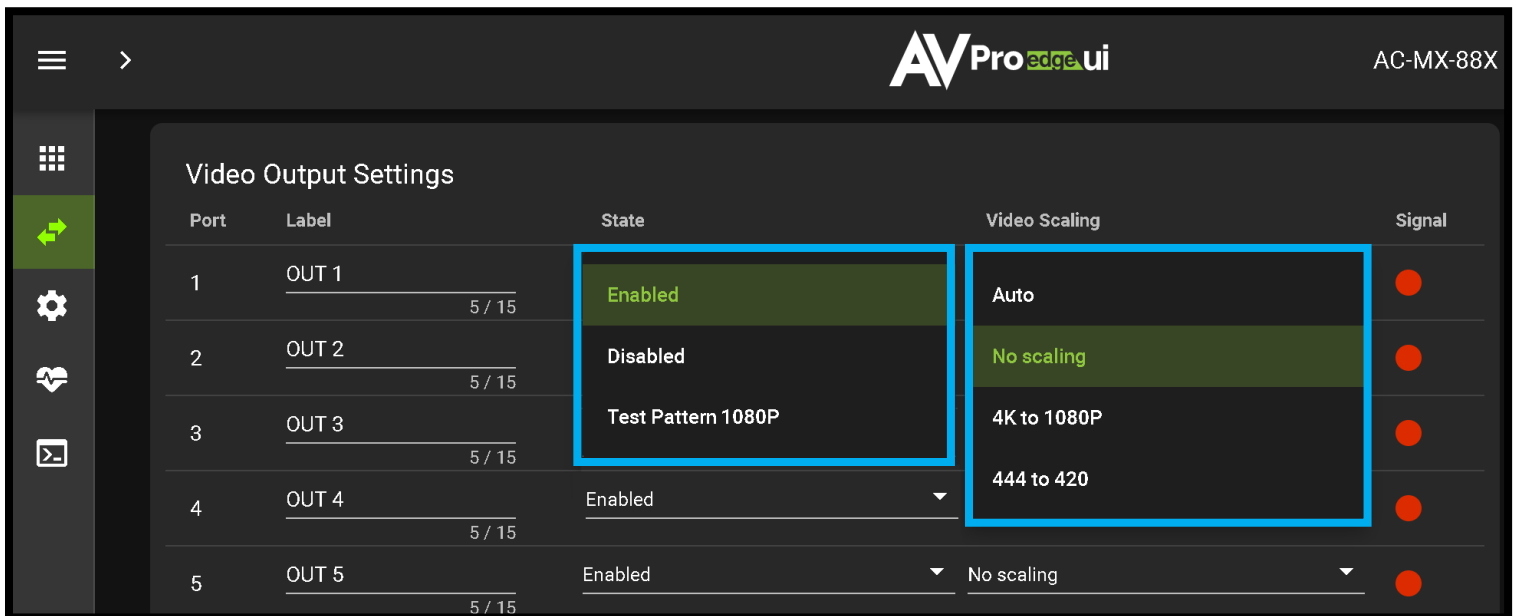

3. Under State there are 4 options.
 - **Enabled** (Default) - HDMI Port is on (normal functionality)
 - **Disabled** - HDMI Output Port will not output a signal
 - **Test Pattern 1080P** - Enables a 1080P Colorbar test pattern on that port
 - **Test Pattern 4K** - Enables a 4K Colorbar test pattern on that port

4. Under the Video Scaling mode you can choose Auto, No Scaling (off), 4K to 1080P, or 1080P to 4K.
 - **Auto** - Will automatically scale based on the connected syncs EDID
 - **No Scaling (Default)** - Signal remains untouched
 - **4K to 1080P** - Down-scales any 4K signal down to 1080P
 - **4:4:4 to 4:2:0** - Will convert any 4K Signal (with a Video Clock above 500MHz) with YUV 4:4:4 and convert it to YUV 4:2:0.

5. Signal - The Signal Indicator on the HDMI outputs shows the current state of the connected HDMI device. Green means HDMI signal is detected, red means that the signal is not detected. If red verify that the HDMI cable is properly connected to both the matrix and HDMI sync device.



Advanced Setup: WebUI Extracted Audio Output Settings

1. Now navigate to the Extracted Audio Output Settings under I/O Config.

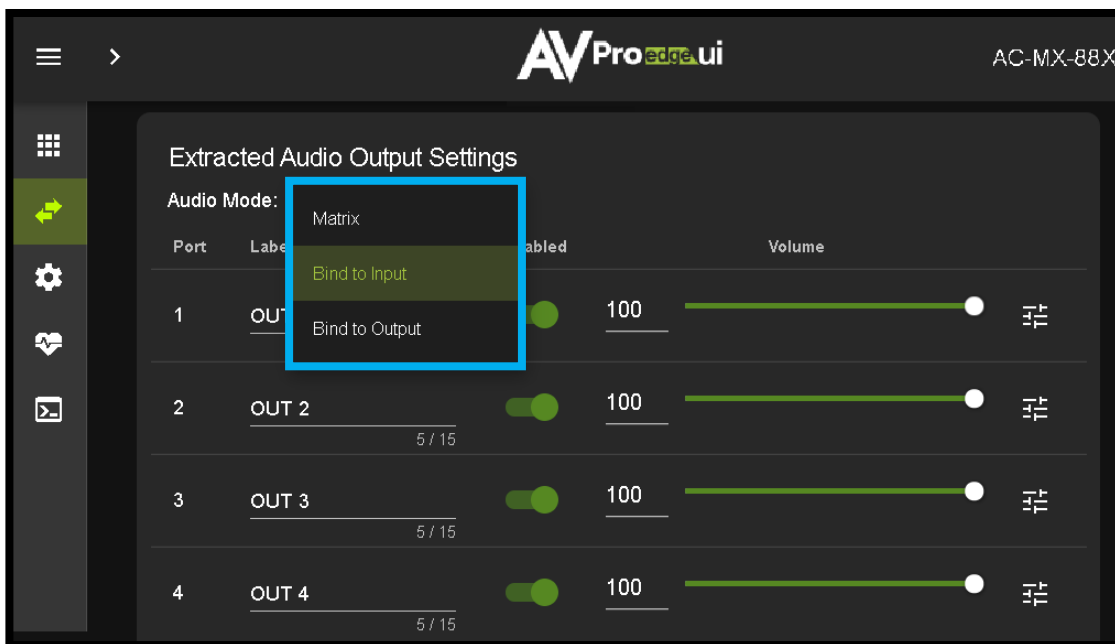

2. The extracted audio ports have 3 distinct operating modes, use the drop-down at the top to select. The three options are.
 - **Bind to Input (Default)** - where the audio port number corresponds to the input signal. This is ideal for systems where audio is matrixed separately in a zoned amplifier.
 - **Bind to Output** - this configuration the audio will automatically follow the HDMI output. This is ideal for systems that use local AVR's for some of the Zones.
 - **Matrix** - This mode allows you to matrix the extracted audio ports independently from the HDMI outputs. In this mode there will be a Tab for the extracted audio under the Matrix page, allowing you to route the audio just like routing the video. If the matrix is set to Bind to Input or Bind to Output this tab will not be visible.

- Other available settings for the extracted audio ports include
 - Enable/Disable Switch
 - Volume control (1-100) - Enter a numbered value, or use the slider bar to adjust
 - EQ presets (7 generic preset options to choose from)
 - Left/Right balance
 - Audio Delay. Each of these 5 settings can be changed per extracted audio port.

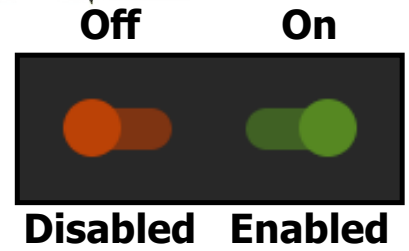

- You can use the slider or text box to change the volume (settings are 0-100).

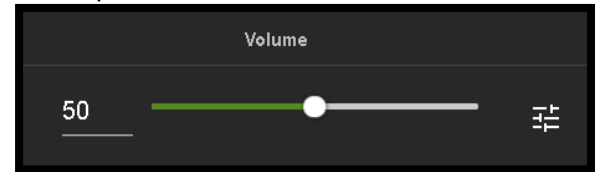

- To change the EQ settings of that port click on the emblem () to the right of the volume slider. This will bring up the Audio Configuration Page. Here you can choose from 8 different EQ settings, change the Left / Right balance, and set the audio delay.

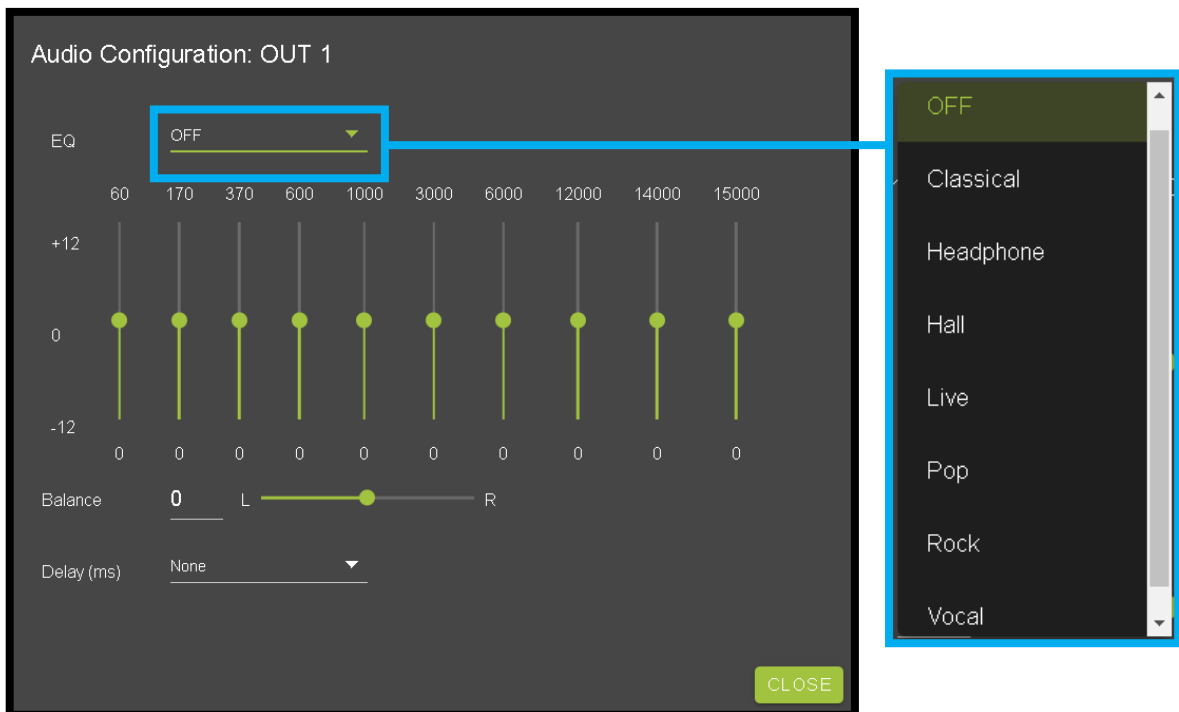
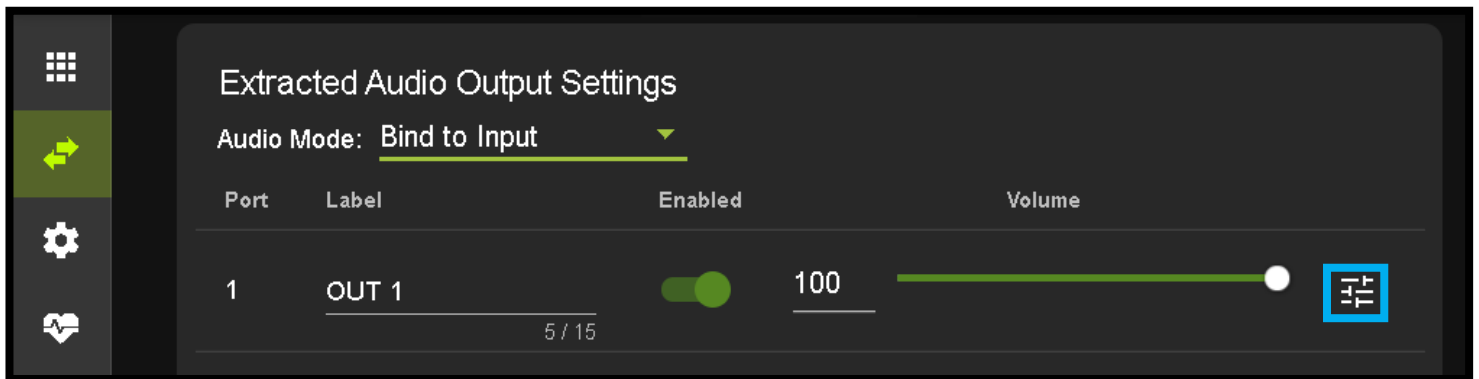

- 6. Delay (eight settings in 90 millisecond increments)
None (default), 90, 180, 270, 360, 450, 540, and 630.

Audio Configuration: OUT 1

EQ OFF

60 170 370 600 1000 3000 6000 12000 14000 15000

+12

0

-12

0 0 0 0 0 0 0 0 0 0

Balance 0 L R

Delay (ms) None

CLOSE

None

90

180

270

360

450

540

630

WebUI: Video Matrix

Use this page to route the video INPUTS and OUTPUTS.

- Click on the INPUT number to select (example below shows IN 1)
- With the INPUT selected simply click on the OUTPUT you want to send that source to.

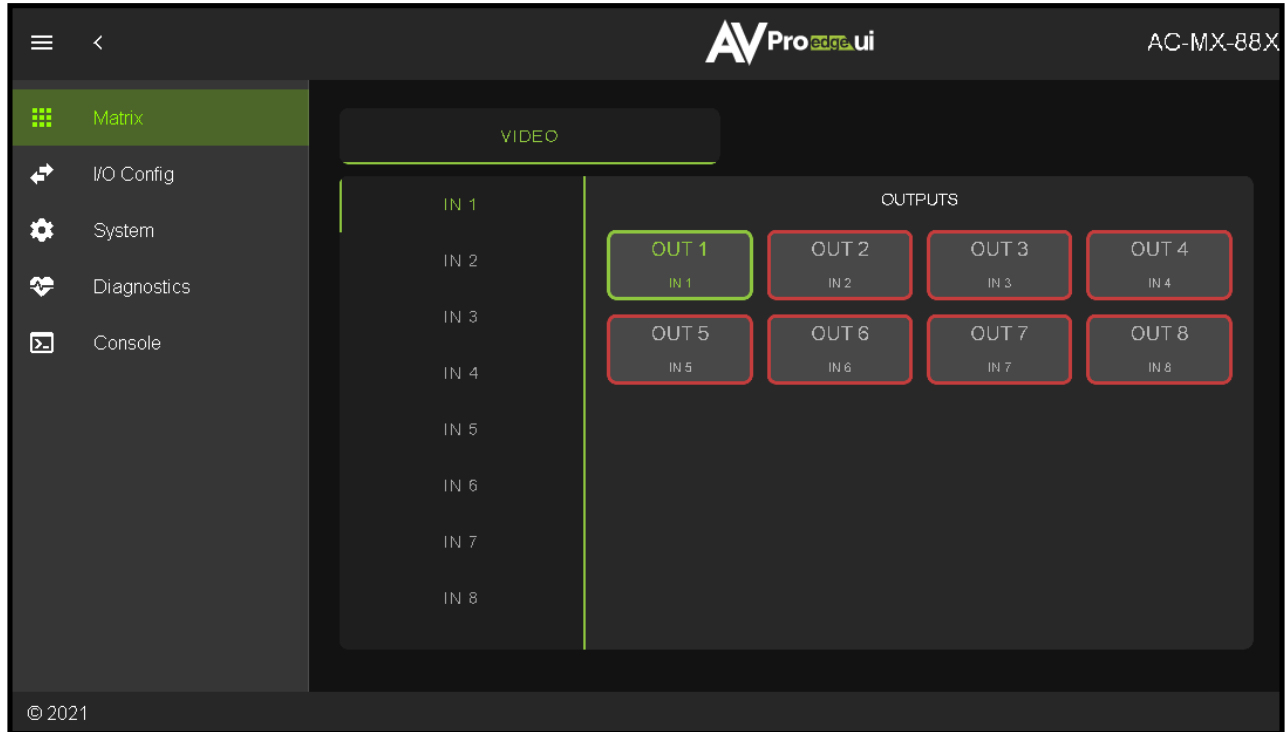

- **Note:** If you rename the INPUTS/OUTPUTS using the I/O Config page they will display here.

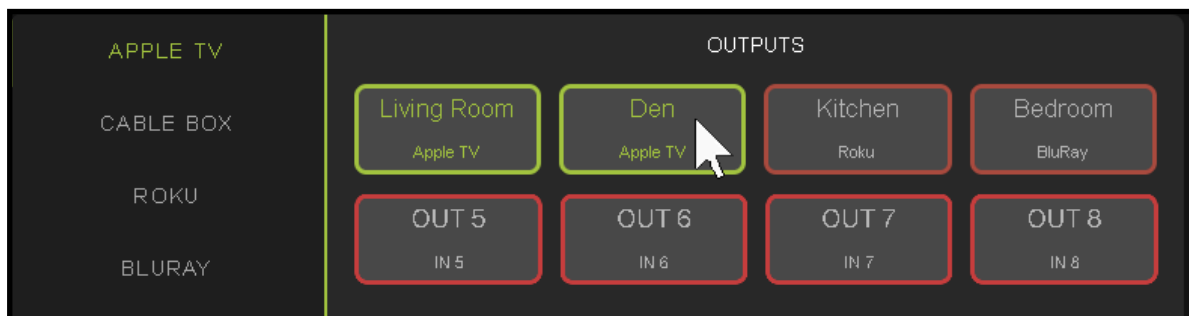
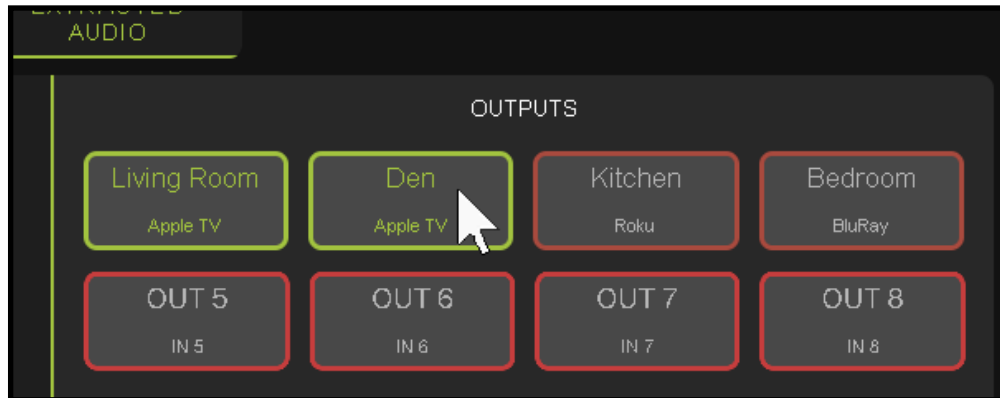

WebUI: Audio Matrix

Use this page to route the extracted audio.

NOTE: The extracted audio ports can only be manually changed (matrixed) when in Matrix Mode. If the extracted audio is set to Bind to Input (default) or Bind to Output then this tab will not be visible, example below. See [Page 14 "Advanced Setup: WebUI Extracted Audio Output Settings"](#) for more info.



- Click on the INPUT number to select (example below shows IN 1 - Apple TV)
- With the INPUT selected simply click on the OUTPUT you want to send that audio to.
- Note: If you rename the INPUTS/OUTPUTS using the I/O Config page they will display here.

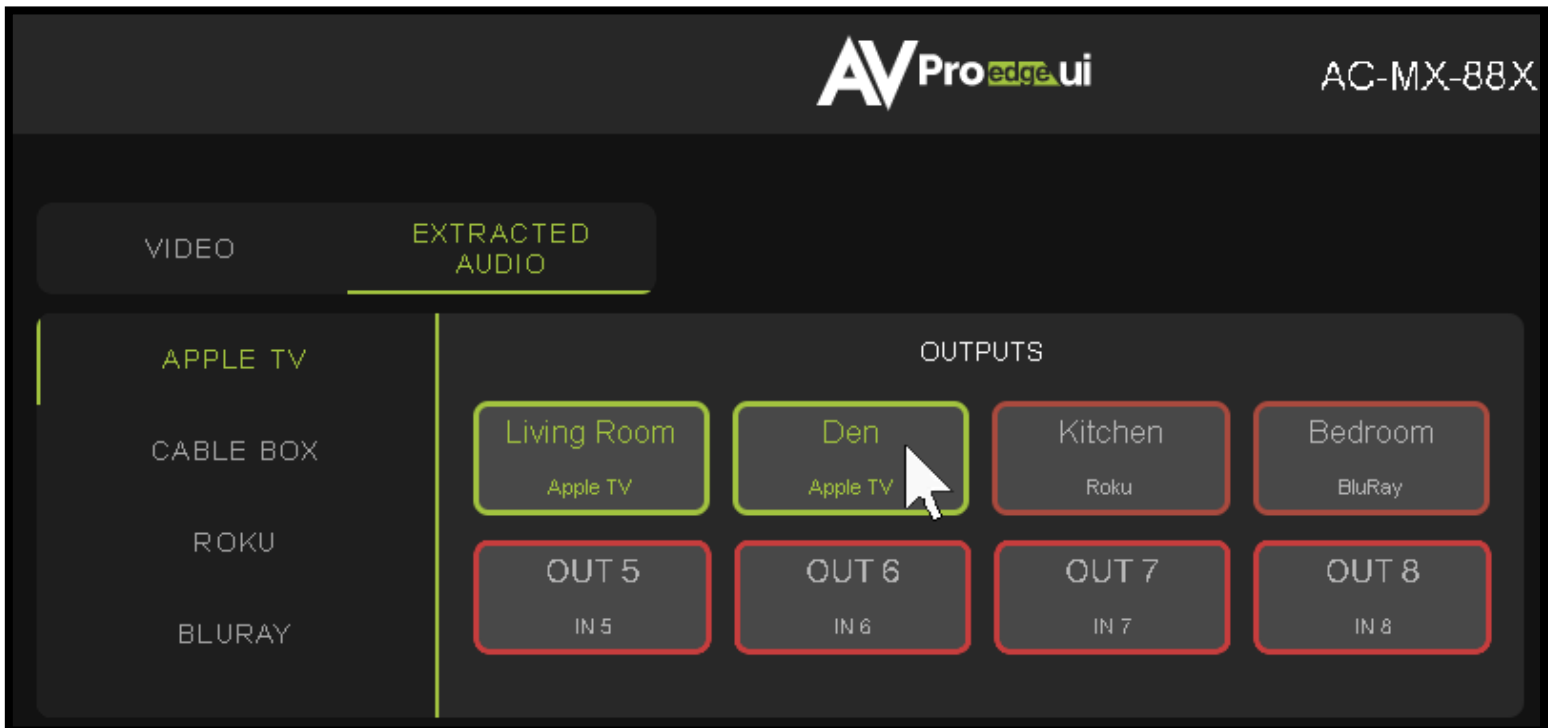

WebUI: I/O Config - Input Settings

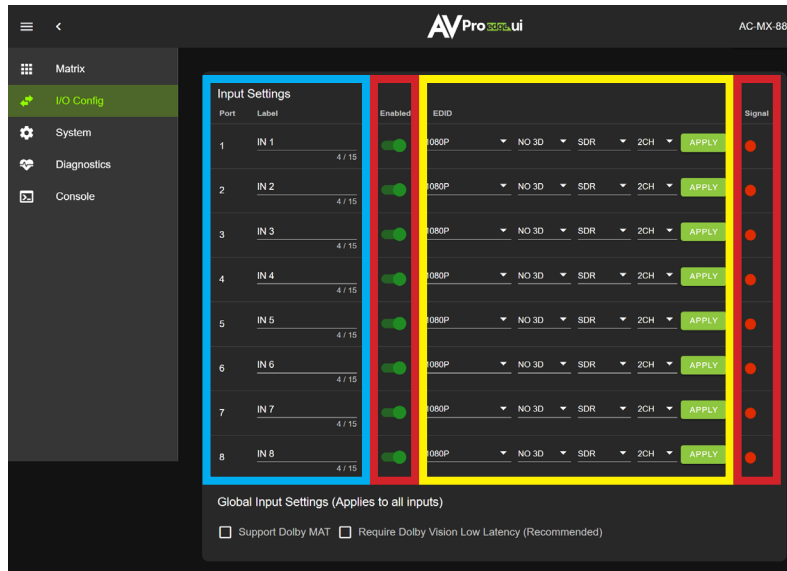

Input Settings Label - Use this to give an name/alias to your inputs (Apple TV, Cable Box, Roku, etc). Note: There is a 15 character limit to this field, the name will replace the default "IN #" throughout the rest of the WebUI (for instance the Video Matrix tab).

Input Settings Enable switch - Use this enable/disable switch to turn the corresponding Input port on or off. The default setting is enabled (green) by default.

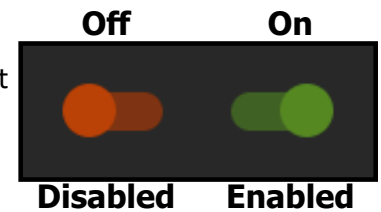

WebUI: I/O Config - Input Settings Cont

Input Settings EDID - Use these four drop-downs to select your preferred EDID. The available combinations are as follows.

- | | | | |
|------------------|-----------------------|-----------------------|---------------------------|
| 1. 1080P_2CH | 9. 4K30HZ_3D_8CH | 17. 1080P_6CH_HDR | 25. 4K60HzY420_3D_2CH_HDR |
| 2. 1080P_6CH | 10. 4K60HzY420_3D_2CH | 18. 1080P_8CH_HDR | 26. 4K60HzY420_3D_6CH_HDR |
| 3. 1080P_8CH | 11. 4K60HzY420_3D_6CH | 19. 1080P_3D_2CH_HDR | 27. 4K60HzY420_3D_8CH_HDR |
| 4. 1080P_3D_2CH | 12. 4K60HzY420_3D_8CH | 20. 1080P_3D_6CH_HDR | 28. 4K60HZ_3D_2CH_HDR |
| 5. 1080P_3D_6CH | 13. 4K60HZ_3D_2CH | 21. 1080P_3D_8CH_HDR | 29. 4K60HZ_3D_6CH_HDR |
| 6. 1080P_3D_8CH | 14. 4K60HZ_3D_6CH | 22. 4K30HZ_3D_2CH_HDR | 30. 4K60HZ_3D_8CH_HDR |
| 7. 4K30HZ_3D_2CH | 15. 4K60HZ_3D_8CH | 23. 4K30HZ_3D_6CH_HDR | |
| 8. 4K30HZ_3D_6CH | 16. 1080P_2CH_HDR | 24. 4K30HZ_3D_8CH_HDR | |

NOTE: If you select USER1 EDID, then drop-downs change to allow you to select from and output to copy from. You can select any of the 4 HDMI outputs then click the COPY button (this replaces the Apply button). This will save that outputs EDID to the USER1 slot.

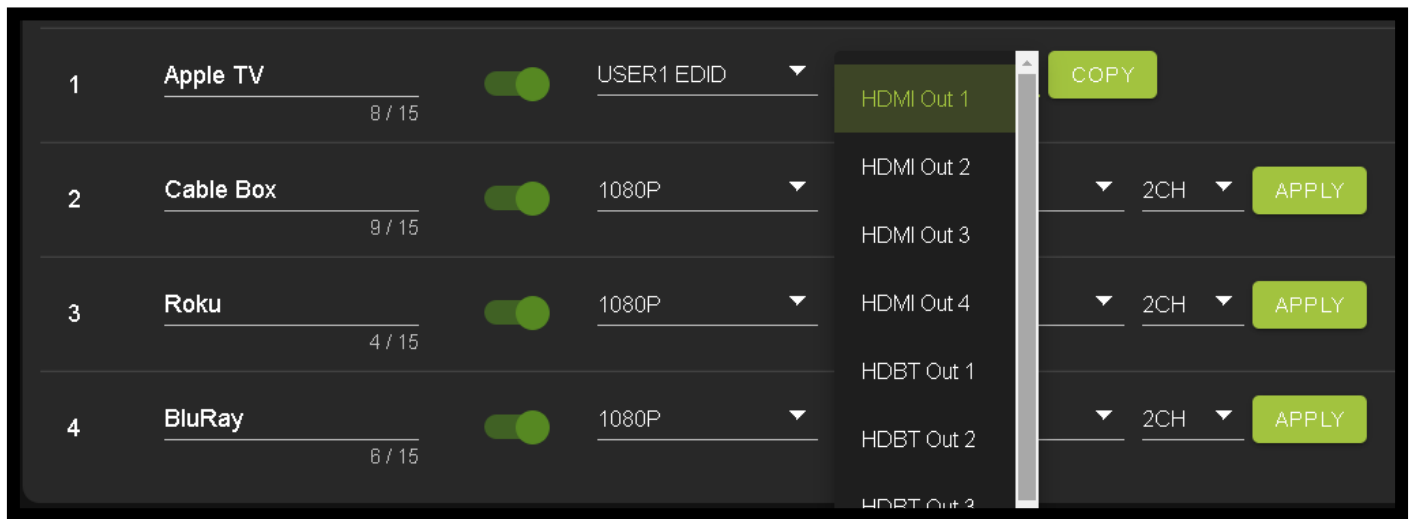

Input Settings Signal - The Signal Indicator on the HDMI INPUTS shows the current state of the connection HDMI source. Green means the HDMI source is detected, red means that the source is not detected. If red verify that source is powered on and that the HDMI cable is properly connected to the source and to the back of the matrix.

Global Input Settings - There are two settings available

- Supports Dolby MAT - Check this box to enable Dolby MAT audio
- Requires Dolby Vision Low Latency - Check this box to require Dolby Vision Low Latency (Player-led) over Standard Dolby Vision (TV-Led). Sources like the Apple TV and X-Box Series X use Low Latency.



WebUI: I/O Config - Output Settings

Port	Label	State	Video Scaling	Signal
1	OUT 1 <small>5 / 15</small>	Enabled	No scaling	●
2	OUT 2 <small>5 / 15</small>	Disabled	4K to 1080P	●
3	OUT 3 <small>5 / 15</small>	Test Pattern 1080p	8K to 4K	●
4	OUT 4 <small>5 / 15</small>	Enabled	No scaling	●
5	OUT 5 <small>5 / 15</small>	Enabled	No scaling	●
6	OUT 6 <small>5 / 15</small>	Enabled	No scaling	●
7	OUT 7 <small>5 / 15</small>	Enabled	No scaling	●
8	OUT 8 <small>5 / 15</small>	Enabled	No scaling	●

Output Settings Label - Use this to give an name/alias to your outputs (Living Room, Den, Kitchen, etc).

Note: There is a 15 character limit to this field, the name will replace the default "OUT #" throughout the rest of the WebUI (for instance the Video Matrix tab).

Output Settings State - This drop-down has 3 settings, just like the input settings you can Enable or disable this port. In addition you can also choose Test Pattern to enable a 1080P color bar test pattern on that output. This is helpful in verifying the signal chain from Matrix to sync (display). To disable the test pattern, change the state back to Enabled (default).

Output Settings Video Scaling - The HDMI outputs each have 3 settings. No scaling (scaling is off), 4k to 1080P, and 8k to 4k.

WebUI: I/O Config - Output Settings Cont.

Output Settings Signal - The Signal Indicator on the HDMI OUTPUTS shows the current state of the connection HDMI Output. Green means HDMI sync is detected, red means that the sync is not detected. If red verify that the output is powered on and that the HDMI cable is properly connected to the sync and to the back of the matrix.



WebUI: I/O Config - Output Settings Cont.

Output Settings Label - Use this to give an alias/name to your extracted audio outputs.

Note: There is a 15 character limit to this field, the name will replace the default "OUT #" throughout the rest of the WebUI (for instance the Video Matrix tab).

Output Settings Enabled - This is an enable/disable switch. By default this will be Enabled/Green. To change the setting simply click to switch. Disabled/Red there will be no Audio passed on that extracted audio port (both Toslink and balanced 5pin will be muted).

Output Settings Volume - Here you can use the slider bar to adjust the extracted port volume (0~100). You can also use the text box and enter a value (0~100).

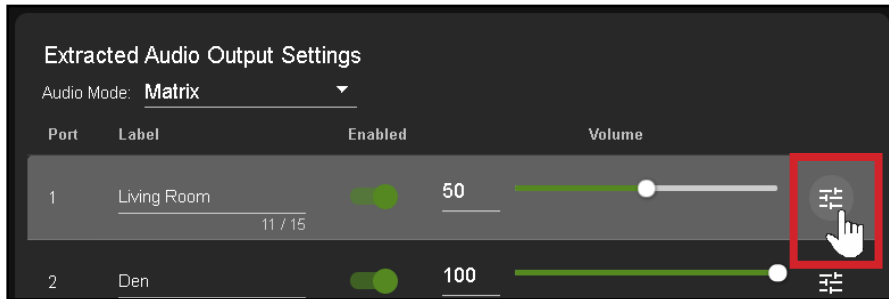

Output Settings EQ Settings - To open the EQ Settings click on the **symbol** next to the Volume slider.

EQ Drop-down contains 8 settings. The default off, Classical, Headphone, Hall, Live, Pop, Rock, and Vocal.

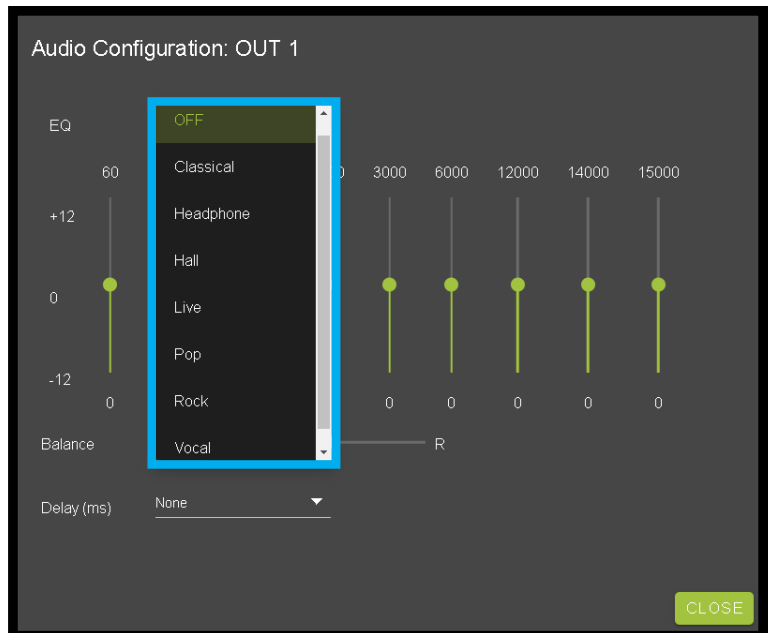
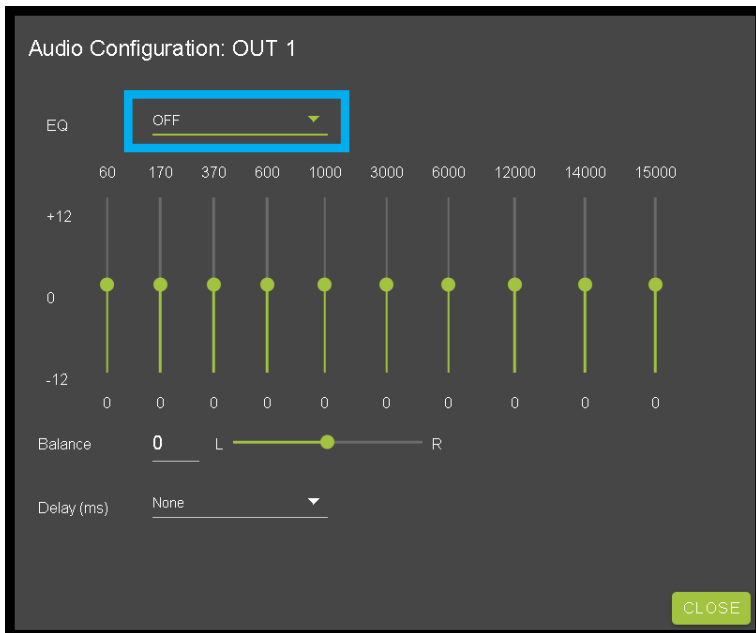

WebUI: I/O Config - Output Settings Cont.

Output Settings Balance - Use this **slider** to adjust the Left/Right balance.

Note: Default is 0 (zero), value can be -10~10

Output Settings Delay (ms) - Audio delay **drop-down** has eight available settings, these are measured in milliseconds.

None (default), 90ms, 180ms, 270ms, 360ms, 450ms, 540ms, and 630ms.



WebUI: System - IP Settings

This area contains relevant network information of the AC-MX-88X.

Host Name - Devices name on the network. This field is automatically filled with Model Name by default.

Model Name - Displays the AVProEdge Model/Part number.

Serial Number - Displays the Serial Number of the matrix.

MAC Address - Displays the devices MAC Address.

IP assignment - This drop-down has two options.

Manual

Automatic (DHCP)

Default out of the box will be set to Automatic (DHCP), the IP Address, Subnet Mask, Gateway, Primary DNS, and Secondary DNS will be assigned by your network controller. If you select Manual, you can use the text fields to enter your own Network settings. Once all fields have been filled out, click the green Apply Button to set. A prompt will appear to confirm the change, click OK to confirm.

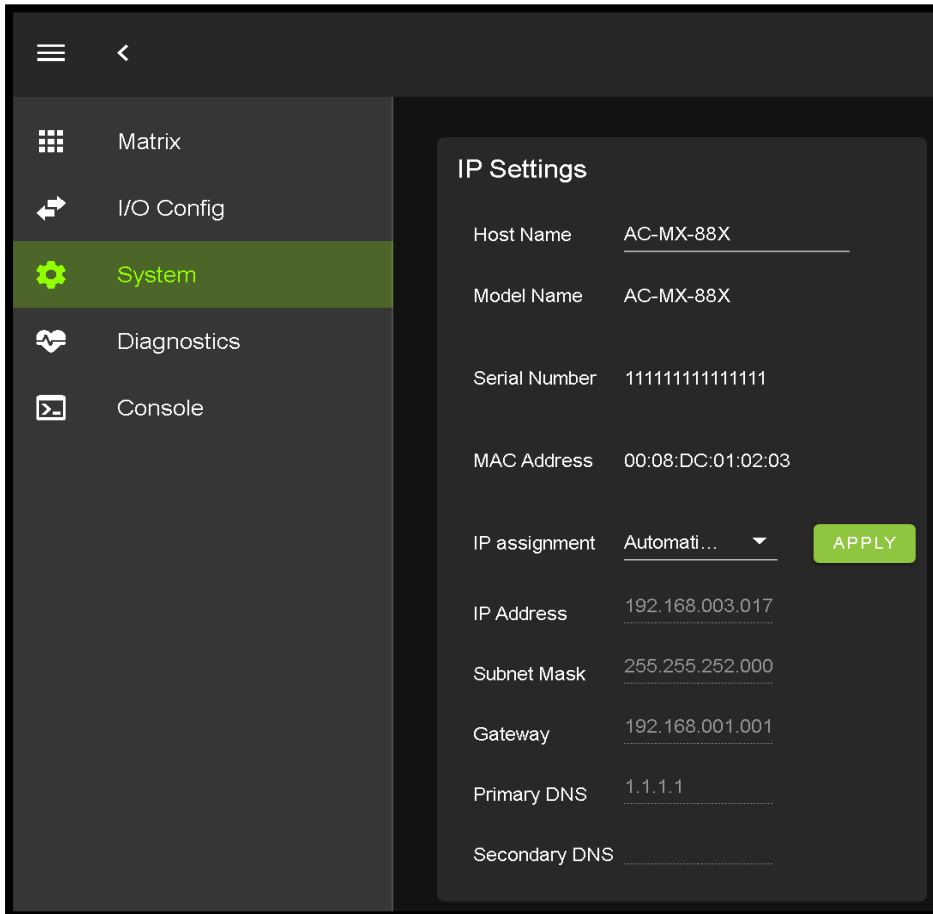

WebUI: System - Telnet Settings

This area contains relevant Telnet settings for the AC-MX-88. There are two fields that can be changed, Enable/Disable switch and the Port Number.

- Enable - This switch has two options, Green/Enabled (Default) and Red/Disabled.
- Port - This field is used to change the Telnet Port of the AC-MX-88. You can use the text field to enter a number or use the Up/Down arrow buttons to increase/decrease the number.

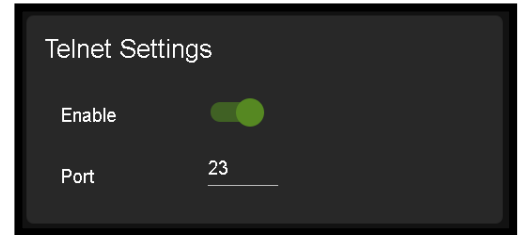

WebUI: System - Admin Web Interface

This switch has two options, Red/Disabled (Default) and Green/Enabled. When enabled (green) there will be three fields that appear, Username, Password, and Confirm Password.

Default Username - admin

Default Password - admin

Once the desired Username and Password has been entered, click the green APPLY button to set.

With the Admin Web Interface enabled, the only menu that will be accessible using the WebUI will be the Matrix tab. The rest of the settings will require the Admin log in to access.

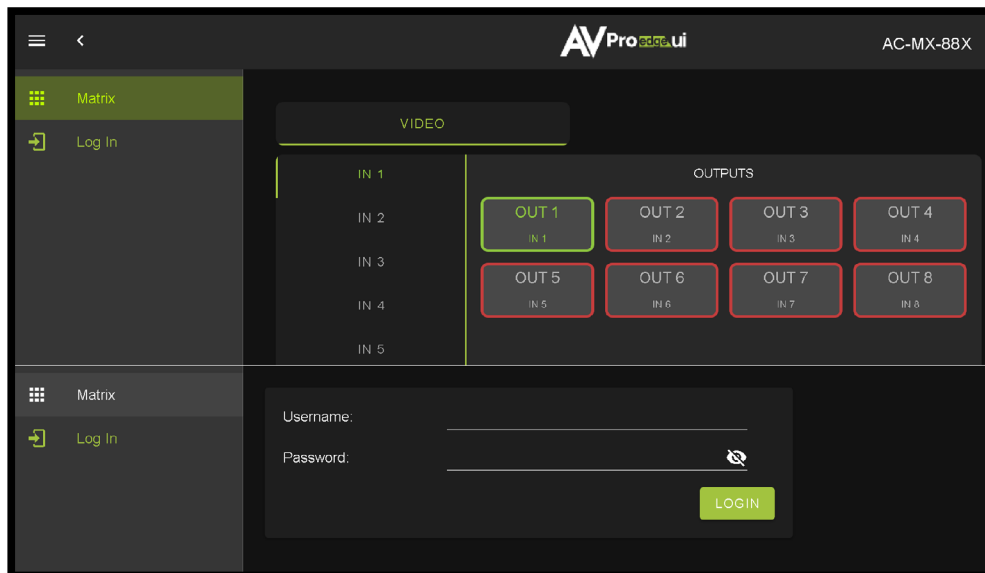
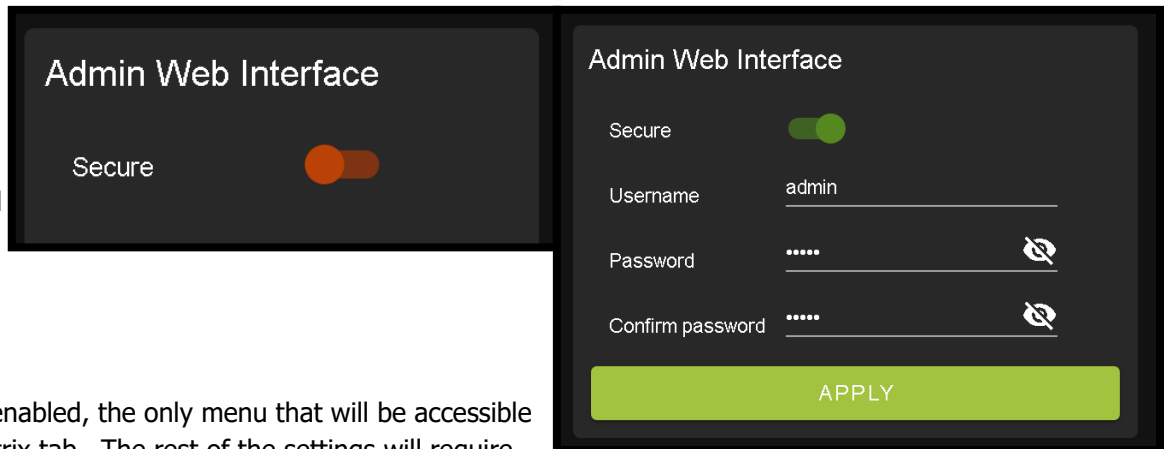

WebUI: System - User Web Interface

This switch has two options, Red/Disabled (Default) and Green/Enabled. When enabled (green) there will be three fields that appear, Username, Password, and Confirm Password.

NOTE: The Admin Web Interface must first be Enabled and setup before this field will be available to change.

Default Username - user

Default Password - user123

Once the desired Username and Password has been entered, click the green APPLY button to set.

Note: The web page will reload to the Log In page.

With both Admin and User Web Interfaces enabled, no menus will be accessible using the WebUI without first logging in (see image below).

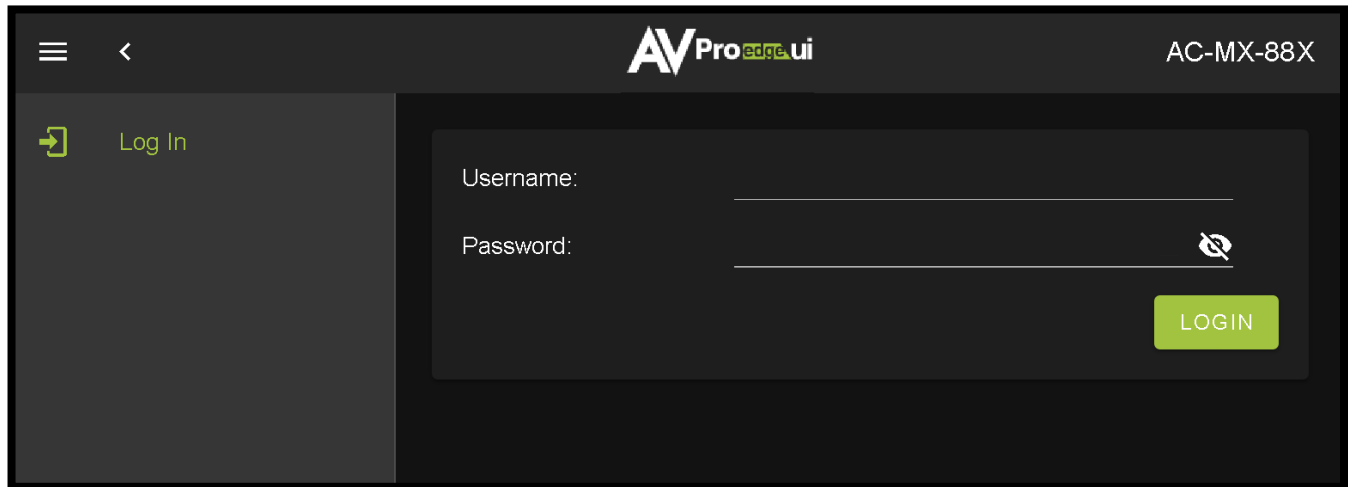
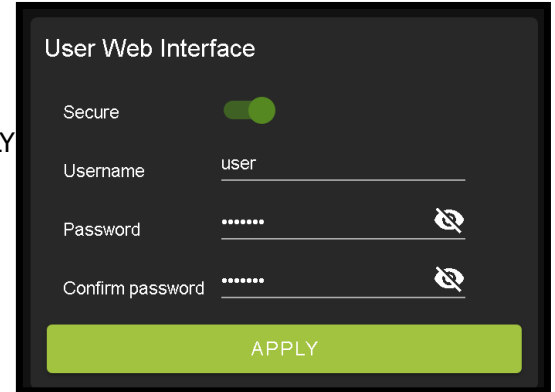

Logging in with the User credentials, the only menu that will be accessible will be the Matrix tab. The rest of the settings will require the Admin user to log in (see page 24).

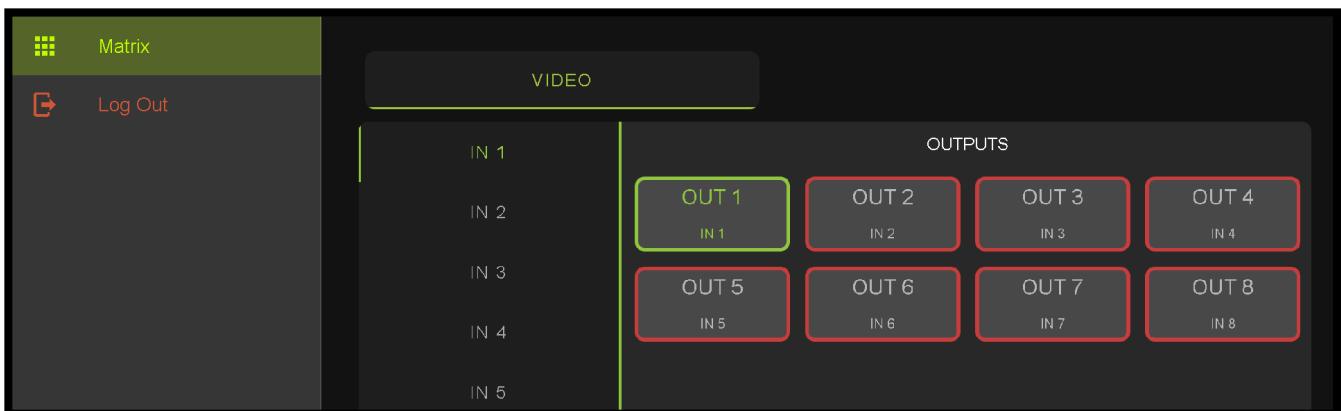

WebUI: System - Cloud Services

By enabling Cloud Services your device will have the ability to connect to firmware servers for over-the-air (OTA) updates and enable third-party remote management services. If Cloud Services are disabled, your device will opt-out of any previously enabled services and will not be able to access OTA updates.

Before you can enable the cloud services you must first agree to the **Privacy Policy** and **Terms of Use**.

You can view these documents by clicking on Privacy Policy or Terms of Use links, this will open up a PDF copy of that document in a new tab.

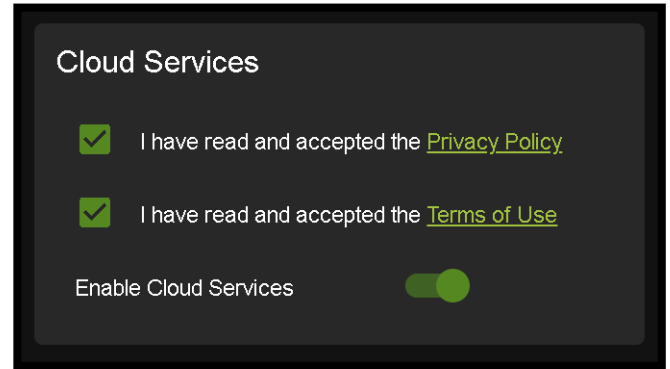
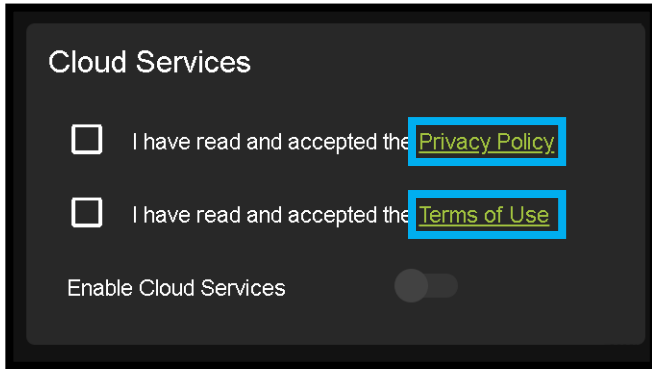

With the Cloud Services enabled you can use the System tab to check for new Firmware OTA (over the air).

This will check the firmware versions currently loaded on the AC-MX-88 and compare to the latest available. If it is up to date, you will see a prompt stating "No update available!" click **CLOSE** to exit.



If an update is available, the following prompt will show. Simply click the **UPDATE** button to load.



NOTE: When loading firmware (depending on the firmware files that are being updated) some settings will revert back to Factory Defaults. Take note of the I/O Config tab. Settings like the INPUT/OUTPUT labels, EDID Settings, Video Scaling, Audio Settings, etc. as they will have to be re-applied after the firmware updates are completed.

If an update is available a file will automatically be selected, simply click the **UPLOAD** button to load the firmware files to the Matrix.

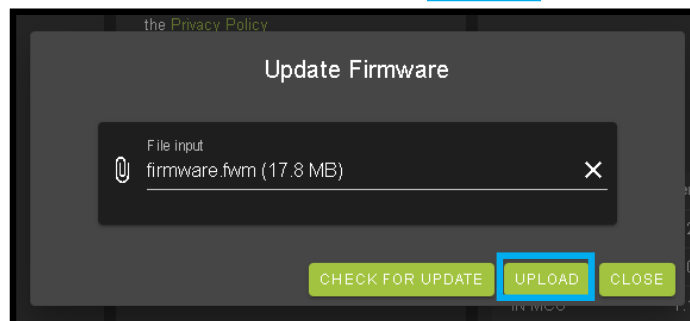

WebUI: System - Firmware Update Cont.

Once the firmware file has been uploaded, it will display all containing firmware files. Here you can select individual firmware files to load or simply leave all files/options selected. If the version currently installed not newer, then that update will be skipped automatically.

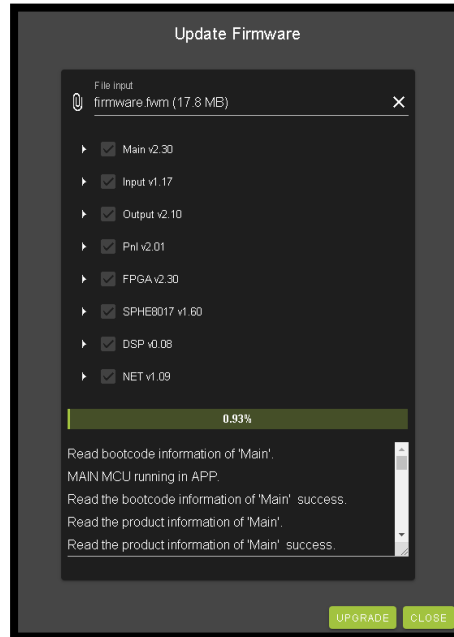
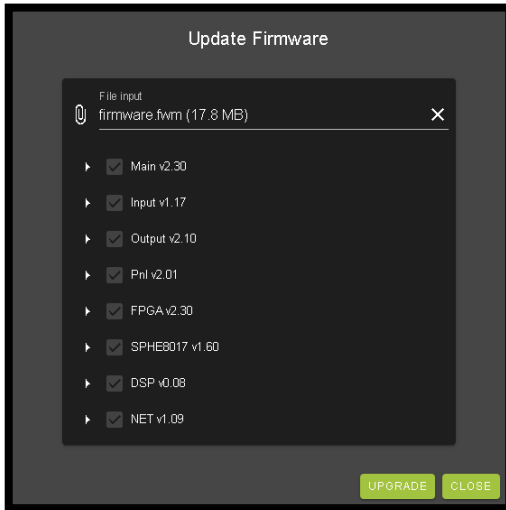

Once the progress bar hits 100% click the CLOSE button, the firmware upgrade process is complete.

Now you will want to go back and re-apply settings like INPUT/OUTPUT Labels, applied EDIDs, Video Scaler Settings, Audio Settings, etc.

WebUI: System - Hardware

LCD Timeout - This adjusts the time the front panel display will stay lit up when a button is pressed.

There are four setting available

- Always on (Default)
- 15 Seconds
- 30 Seconds
- 45 Seconds

Keypad Lock - Enable or Disable (default) the front panel Keypad Lock.

MCU/Version - Lists the current Firmware Versions

UPDATE FIRMWARE - Check/upload firmware.

FACTORY RESET - Restores matrix to Factory Defaults

REBOOT - Reboots the AC-MX-88

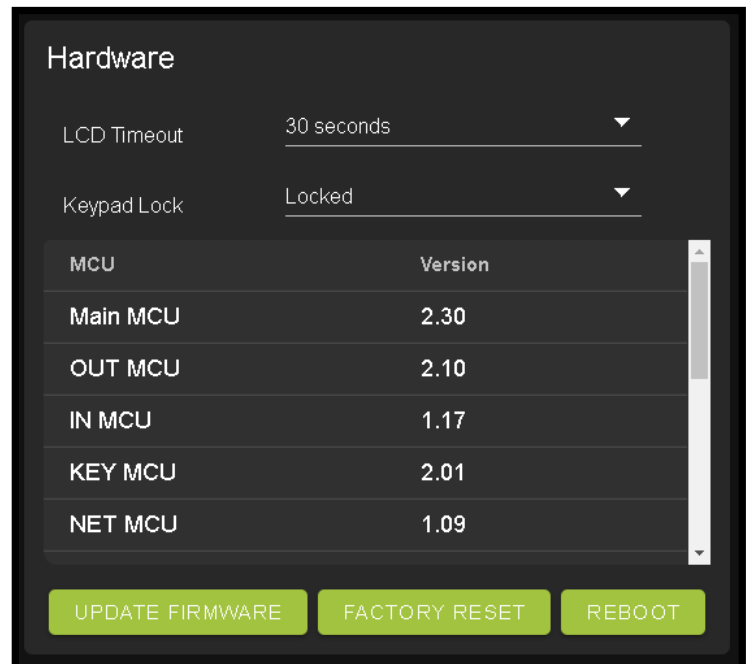

WebUI: Diagnostics - HDMI IN

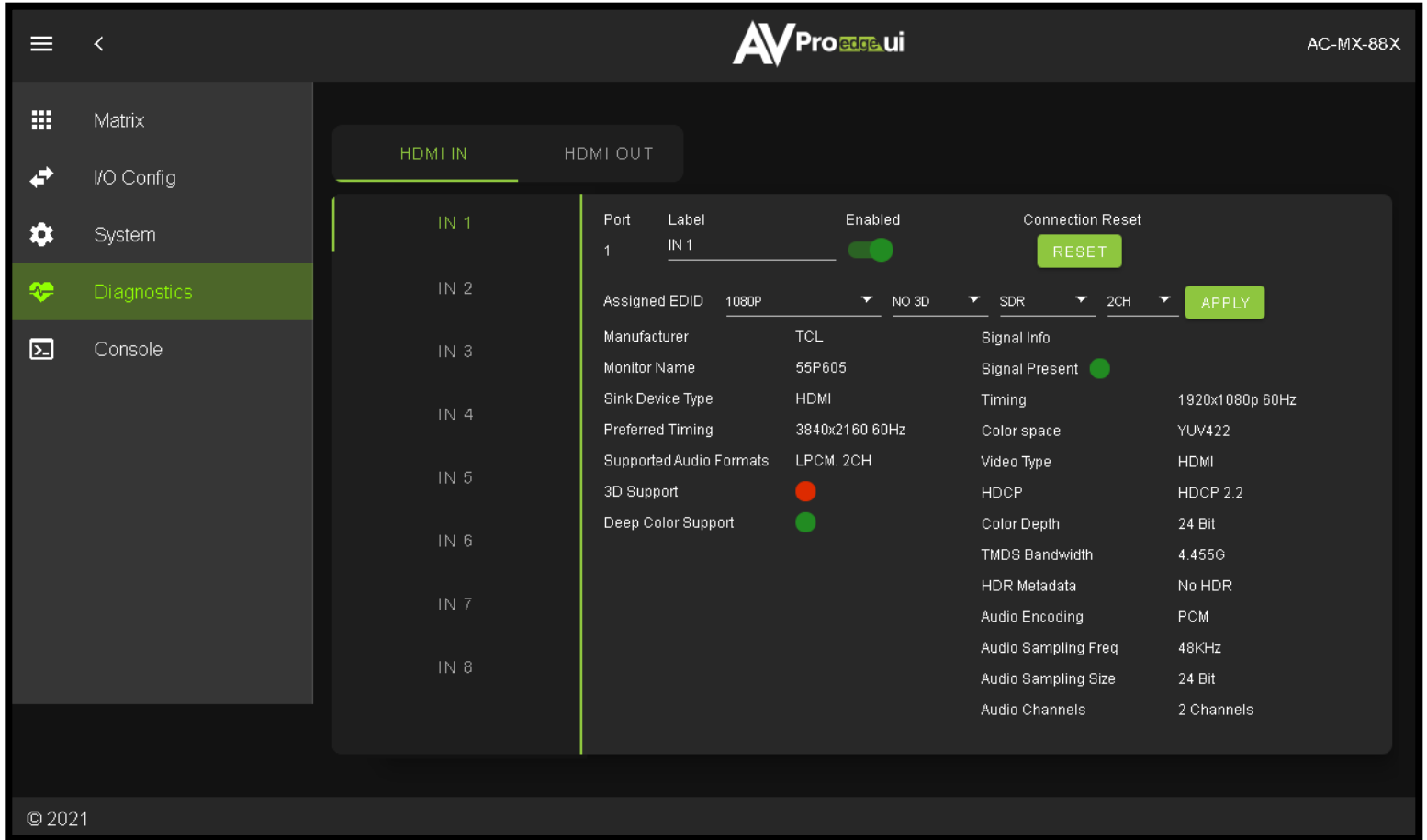

Input Settings Label - Use this to give an name/alias to your inputs (Apple TV, Cable Box, Roku, etc).

Note: There is a 15 character limit to this field, the name will replace the default "IN #" throughout the rest of the WebUI (for instance the Video Matrix tab).

Input Settings Enable switch - Use this enable/disable switch to turn the corresponding Input port on or off. The default setting is enabled (green) by default.

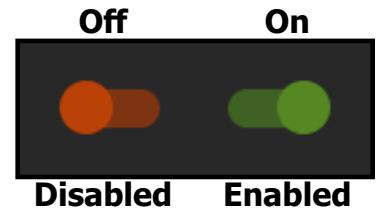

Connection Reset - Use this button to perform a reset of the HDMI Input connection.

Input Settings EDID - Use these four drop-downs to select your preferred EDID. The available combinations are as follows.

- | | | | |
|------------------|-----------------------|-----------------------|---------------------------|
| 1. 1080P_2CH | 9. 4K30HZ_3D_8CH | 17. 1080P_6CH_HDR | 25. 4K60HzY420_3D_2CH_HDR |
| 2. 1080P_6CH | 10. 4K60HzY420_3D_2CH | 18. 1080P_8CH_HDR | 26. 4K60HzY420_3D_6CH_HDR |
| 3. 1080P_8CH | 11. 4K60HzY420_3D_6CH | 19. 1080P_3D_2CH_HDR | 27. 4K60HzY420_3D_8CH_HDR |
| 4. 1080P_3D_2CH | 12. 4K60HzY420_3D_8CH | 20. 1080P_3D_6CH_HDR | 28. 4K60HZ_3D_2CH_HDR |
| 5. 1080P_3D_6CH | 13. 4K60HZ_3D_2CH | 21. 1080P_3D_8CH_HDR | 29. 4K60HZ_3D_6CH_HDR |
| 6. 1080P_3D_8CH | 14. 4K60HZ_3D_6CH | 22. 4K30HZ_3D_2CH_HDR | 30. 4K60HZ_3D_8CH_HDR |
| 7. 4K30HZ_3D_2CH | 15. 4K60HZ_3D_8CH | 23. 4K30HZ_3D_6CH_HDR | |
| 8. 4K30HZ_3D_6CH | 16. 1080P_2CH_HDR | 24. 4K30HZ_3D_8CH_HDR | |

WebUI: Diagnostics - HDMI IN Cont.

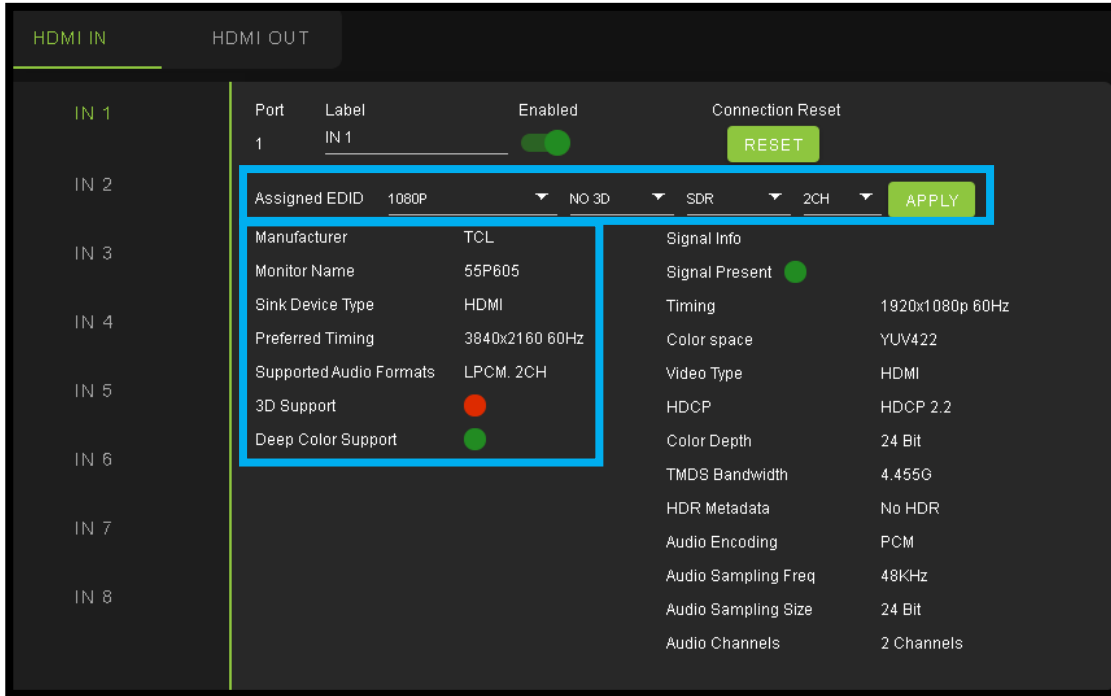

On the left, you will see the current applied EDID information. In the example above, you will see a canned 1080P - No 3D - SDR - 2CH EDID applied to IN 1. Any EDID change, once applied will display here.

Signal Info shows the connected source's current output information. This includes

- Timing
- Color Space
- Video Type
- HDCP Version
- TMDS Bandwidth
- HDR Metadata
- Audio Sampling Frequency
- Audio Sampling Size
- Audio Channels

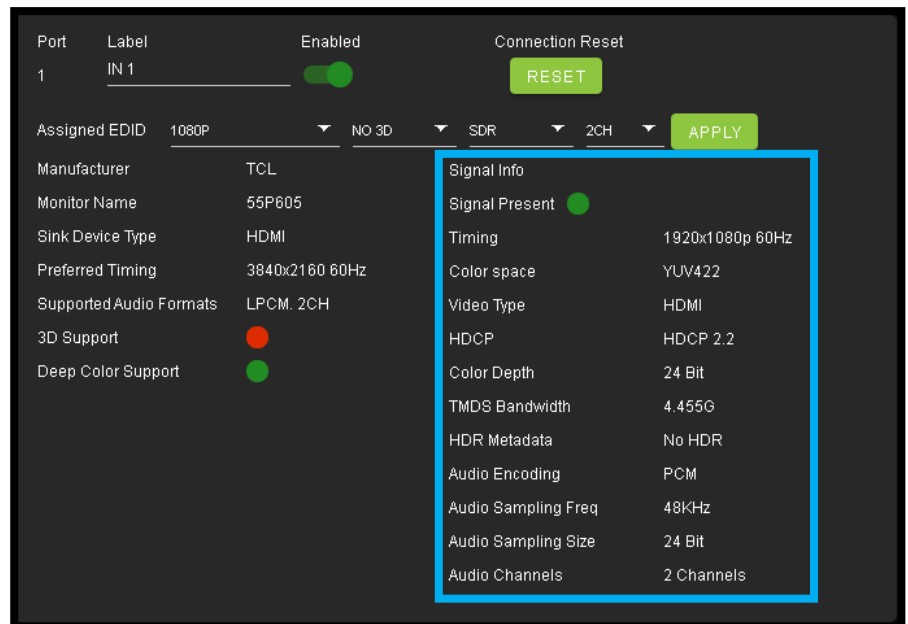

WebUI: Diagnostics - HDMI OUT

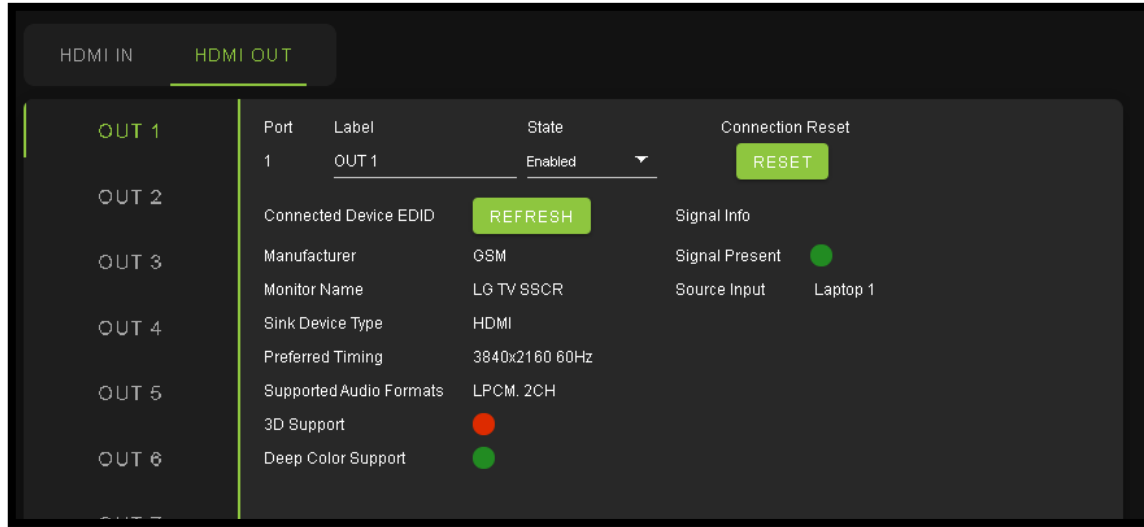

HDMI Output Label, State, and Connection Reset.

Connected Device EDID shows the connected sync's preferred EDID information and current state.

This includes

- Manufacturer
- Monitor Name
- Sink Device Type
- Preferred Timing
- Supported Audio Formats
- 3d Support
- Deep Color Support
- Signal Present
- Source Input (future update)

WebUI: Console

There is a built in Command Console

Using the command API (command list) you can send device specific commands or use as a live monitor while sending commands from a control system (helpful in troubleshooting).

Example

1. Click in the white box and type
 - a. GET STA

Click the green arrow or hit ENTER/RETURN on your keyboard

The the command response will show in the field below.

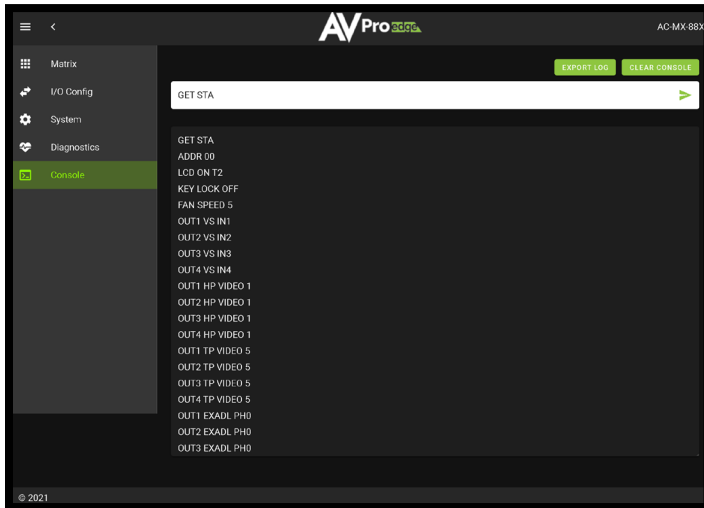
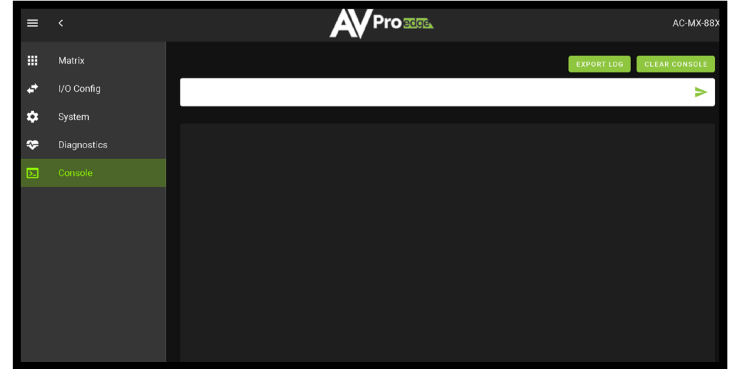

Example - "GET STA"
Get status

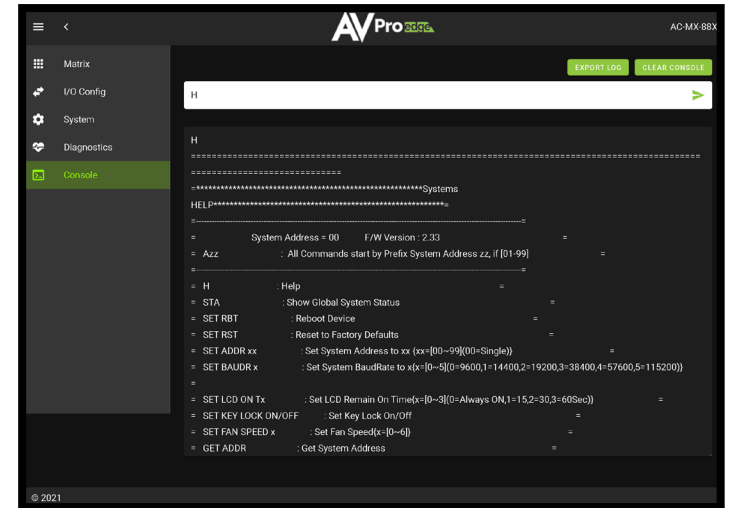

Example - "H"
Help command
Returns all Available Commands

*NEW to NET MCU Firmware Version 1.06

EXPORT LOG - Button

This button will generate a text file containing the console information in your web browsers download folder.



CLEAR CONSOLE - Button

This button will clear the current console session.

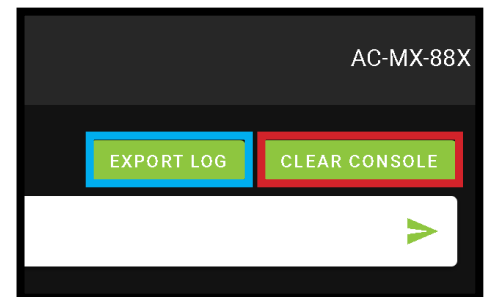

Front Panel Control - Switching

The AC-MX-88X can be switched from the front panel by first pressing the desired OUTPUT (bottom row) button first, then by pressing the desired INPUT button (top row).

1. Press the OUTPUT button (1 through 4) on the bottom row that corresponds with the OUTPUT (Display, or Sink Device) you would like to send to a source.
2. Once pressed, the front panel display will change to the SWITCH menu showing the current IN/OUT routes. Press the corresponding OUTPUT button (top row) to set.

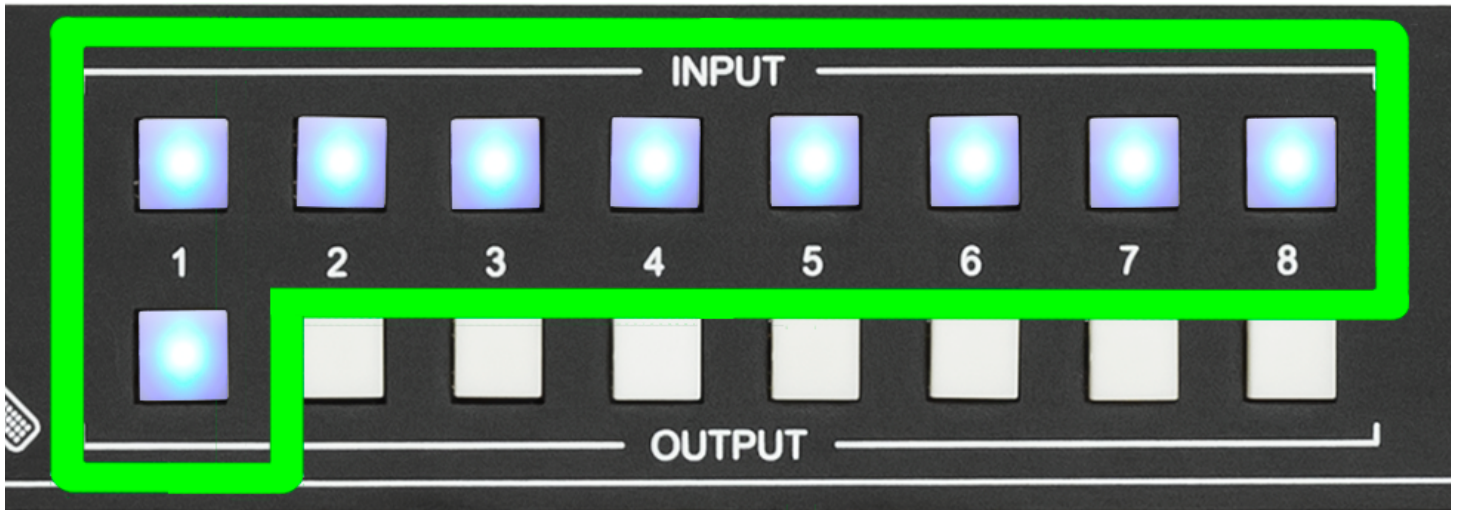

You can also use the arrow keys and navigate to SWITCH on the front screen display.

1. Use the left/right arrows to select the OUTPUT press the OK button (the selection will turn red).
2. With the selection now red press the desired OUTPUT button (1-4) that you want to route to that INPUT.

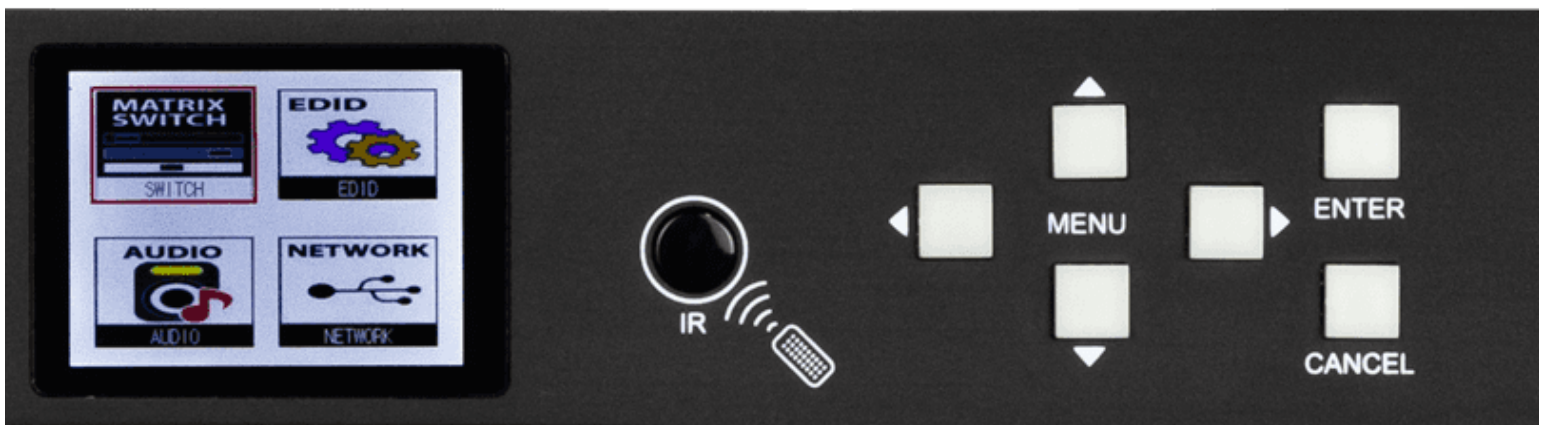

Front Panel Control - EDID

This matrix has 29 factory defined EDID settings. It also has 3 user defined EDID memories. The user EDID memories are independent to each input and can be set differently. The user defined EDID can be uploaded using the free PC Control software or RS-232. In addition, you can choose to read the EDID from the desired output and the captured EDID will automatically store and overwrite the EDID in "USER EDID 1" and will be applied to the selected source.

- Use the arrow keys to highlight EDID then press OK to enter the EDID management menu.



- Use the Left/Right arrow to select one of the 4 INPUTS, and press OK.
- The EDID Status will turn red, now you can use the UP/DOWN arrows to change the EDID.
- Once the desired EDID is selected, press the OK button to set.

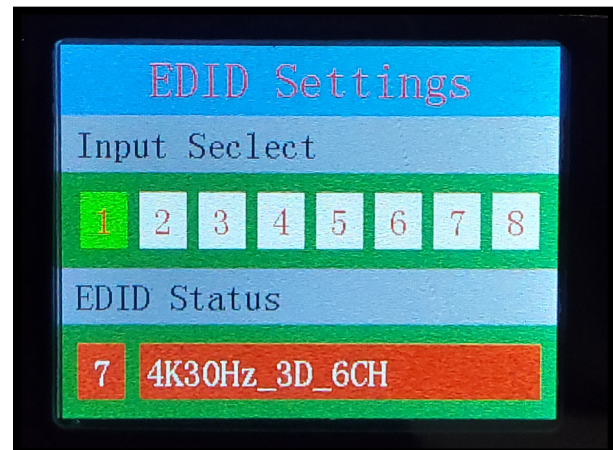
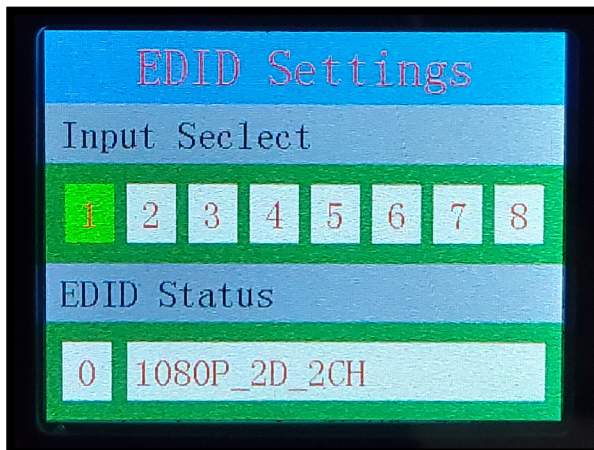

NOTE: See page[s] 18 and 37 for full EDID list

Front Panel Control - Audio

Once in "Matrix" mode for audio, the extracted audio routing on the AC-AXION-8 can be controlled from the front panel.

To Control:

1. Navigate to the Audio Menu.
2. Use the arrow key to highlight "Audio Mode" and press OK to select. The field will turn red.
3. Use up/down arrow keys to change to "Matrix".
4. Press the OK button again to set.
5. With the Audio Mode set to Matrix, you can use the INPUT/OUTPUT Buttons to route the audio. Press OUTPUT number first, then the INPUT number next.

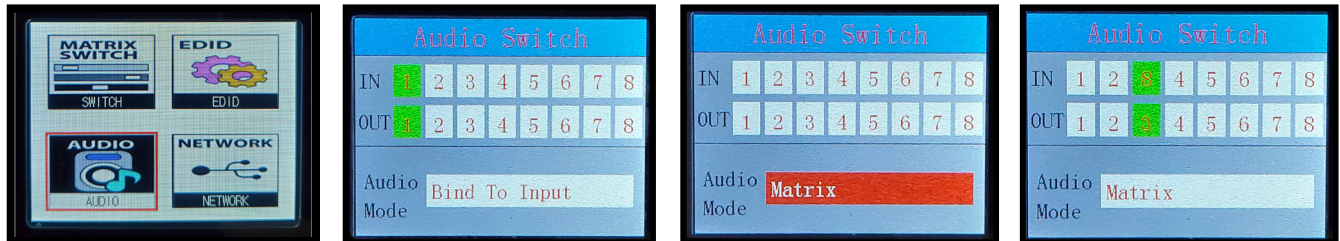

Front Panel Control - Network

This menu displays the current Network information. You can edit the following Network settings from the front panel.

- RIP
- HIP
- MASK
- TCP/IP
- DHCP

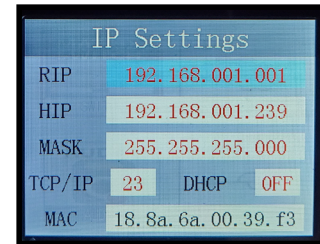
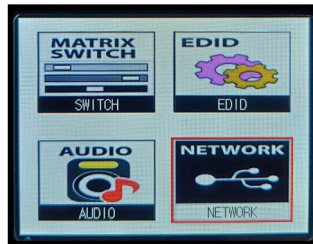

NOTE: The MAC Address is only viewable, you can not edit.

To change a setting:

1. Use the up/down arrow keys to highlight the setting you would like changed and press OK to select. The field will turn green.
2. Use up/down/left/right arrow keys to change the value.
3. Press the OK button again to set.

IR Control: IR Remote

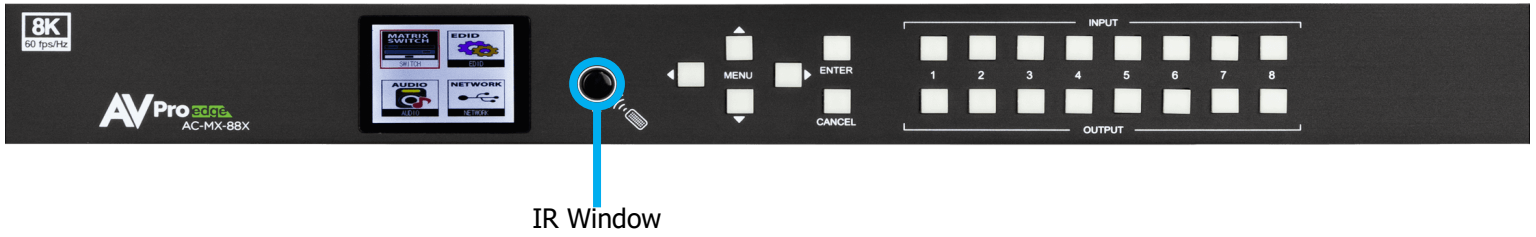

IR Remote Control:

When routing HDMI, the matrix can be controlled by using the IR remote supplied. When routing HDMI, the matrix can be controlled by using the IR remote supplied with the product (battery not included, requires CR2025).

The labels on the left are the **OUTPUT** numbers.

The **arrow** buttons are for cycling through the INPUTS. Pressing the left arrow will decrease (move to previous input) and pressing the right arrow will increase (move to next input).



IR Control: Extension Port

The IR EXT. port on the back can accept an IR Receiving Eye (one included in the box).



RS-232 and TCP/IP Control

The AC-MX-88 can be controlled with either RS-232 or TCP/IP commands. Certain switching or format configurations can only be done using these commands. We recommend using either the MyUART (RS-232 - free) or Hercules (TCP/IP - free) apps as they are very easy to use for sending commands to the machine.

For TCP/IP control commands use Telnet Port 23.

For RS-232, use a null modem serial cable adapter and set the serial communications to: 57600,n,8,1 (baud: 57600, no parity, 8 data bits and 1 stop bit) with no handshaking.

Please add a carriage return (Enter key) after each command when using direct commands.

The unified command list (ASCII) is listed on the following pages. Text version available [here](#), and under the resources tab of on the products [web page](#).

USB CONTROL FOR AVPRO EDGE

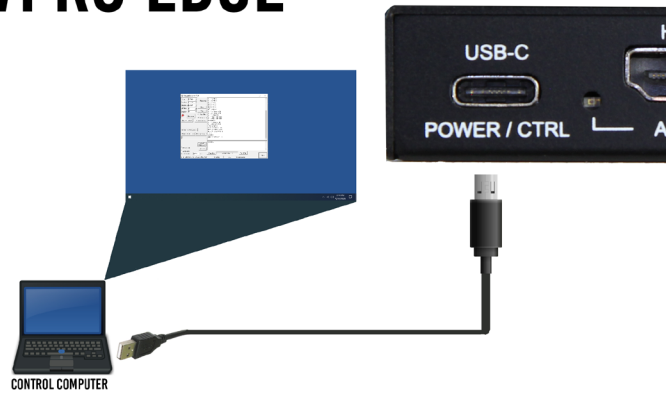
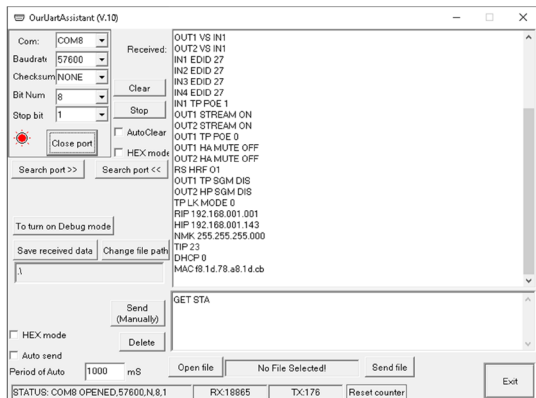

WWW.AVPROEDGE.COM/DRIVERS

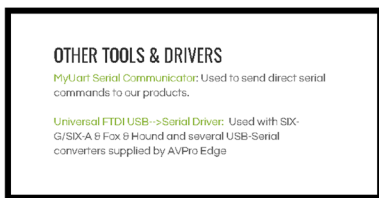

RS-232 CABLE FOR AVPRO EDGE

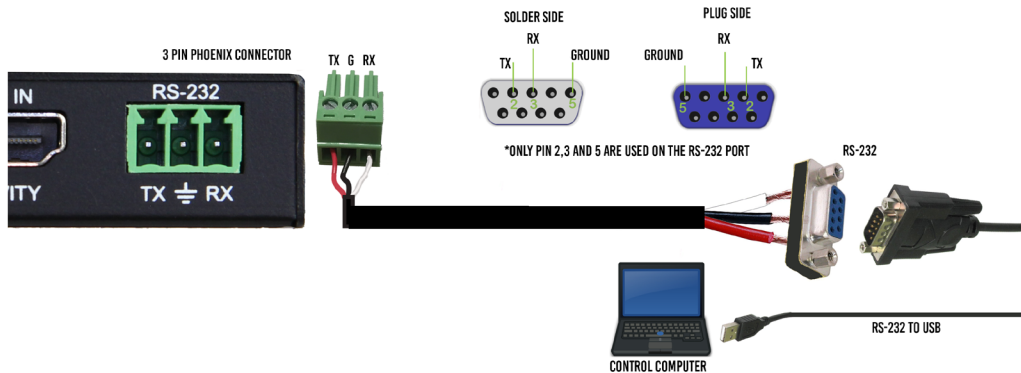

Command List

- Baudrate: 57600
- Bit Num: 8
- Checksum: None
- Stop Bit: 1

Command:	Action
H	: Help
STA	: Show Global System Status
SET RST	: Reset to Factory Defaults
SET RBT	: System Reset to Reboot
SET LAN RBT	: SET LAN MCU Reset to Reboot
SET ADDR xx	: Set System Address to xx {xx=[00-99](00=Single)}
SET LCD ON Tx	: Set LCD Remain On Time{x=[0~3](0=Always ON,1=15,2=30,3=60Sec)}
SET KEY LOCK ON/OFF	: Set Key Lock On/Off
SET FAN SPEED x	: Set Fan Speed{x=[0~6]}
GET ADDR	: Get System Address
GET STA	: Get System System Status
GET BAUDR	: Get System BaudRate
GET INx SIG STA	: Get Input x Signal Status{x=[0~8](0=ALL)}
GET OUTx SIG STA	: Get Output x Signal Status{x=[0~8](0=ALL)}
GET OUTx HPD	: Get HDMI Output x HPD Status{x=[0~8](0=ALL)}
GET LINKx VID FMT INF	: Get Input x Video Format Info{x=[0~8](0=ALL)}
GET LINKx AUD FMT INF	: Get Input x Audio Format Info{x=[0~8](0=ALL)}
GET LCD ON T	: Get LCD Remain On Time
GET KEY LOCK	: Get Key Lock Status
Output Setup Commands:	
SET OUTx VS INy	: Set Output x To Input y{x=[0~8](0=ALL), y=[1~8]}
SET OUTx VIDEOy	: Set Output x VIDEO Mode y {x=[0~8](0=ALL), y=[1,2,6](1=BYPASS,2=4K->2K,6=8K->4K)}
SET OUTx EXA EN/DIS	: Set Ex-Audio Output Enable/Disable{x=[0~8](0=ALL)}
SET OUTx EXADL PHY	:Set Ex-Audio Delay{x=[0~8](0=ALL), y=[0~7](0=Bypass,1~7=90,180,270,360,450,540,630MS)}
SET EXAMX MODEx	: Set Ex-Audio Matrix Mode{x=[0~2](0=Bind To Output,1=Bind To Input,2=Matrix)}
SET OUTx AS INy	: Set Ex-Audio Output x To Input y{x=[0~8](0=ALL), y=[1~8]}
SET OUTx EXAUD LEVy	: Set Output x EQ-Audio Volume Levely{x=[0-8](0=all),y=[0~100]}
SET OUTx EXA LVLy	: Set Output x Ex-Audio(Balanced) Left Volume Levely{x=[0~8](0=ALL),y=[0~10]}
SET OUTx EXA RVLy	: Set Output x Ex-Audio(Balanced) Right Volume Levely{x=[0~8](0=ALL),y=[0~10]}
SET OUTx EXEQ MODEy	: Set Output x EX-Audio Volume EQ Modey{x=[0-8](0=ALL),y=[0~7]} : y=[0-OFF],[1-Classical],[2-Headphone],[3-Hall],[4-Live],[5-Pop],[6-Rock],[7-Vocal]
SET OUTx STREAM ON/OFF	: SET OUTx STREAM ON/OFF{x=[0~8](0=ALL)}
GET OUTx VS	: Get Output x Video Route{x=[0~8](0=ALL)}
GET OUTx VIDEO	: Get HDMI Output x Video Mode{x=[0~8](0=ALL)}
GET OUTx EXA	: Get Ex-Audio Output Enable/Disable Status{x=[0~8](0=ALL)}
GET OUTx EXADL PH	: Get Ex-Audio Output Delay Status{x=[0~8](0=ALL)}
GET EXAMX MODE	: Get Ex-Audio Matrix Mode
GET OUTx AS IN	: Get Output x Ex-Audio Route{x=[0~8](0=ALL)}
GET OUTx EXAUD LEV	: Get Output x EQ-Audio Volume Level{x=[0~8](0=all)}
GET OUTx EXAUD LEV	: Get Output x EQ-Audio Volume Level{x=[0-8](0=all)}
GET OUTx EXA LVL	: Get Output x Ex-Audio(Balanced) Left Volume Level{x=[0~8](0=all)}
GET OUTx EXA RVL	: Get Output x Ex-Audio(Balanced) Right Volume Level{x=[0~8](0=all)}
GET OUTx EXEQ MODE	: Get Output x EX-Audio Volume EQ Mode Status{x=[0-8](0=ALL)}
GET OUTx STREAM	: Get Output x Stream ON/OFF Status{x=[0~8](0=ALL)}
GET OUTx EDID DATA	: Get Output x EDID DATA{x=[1~8]}

Command List Continued

Input Setup Commands:	
SET INx EDID y	: Set Input x EDID{x=[0~8](0=ALL), y=[0~32]}
0:1080P_2CH(PCM)	1:1080P_6CH
3:1080P_3D_2CH(PCM)	4:1080P_3D_6CH
6:4k30Hz_3D_2CH(PCM)	7:4k30Hz_3D_6CH
9:4K60Hz(Y420)_3D_2CH(PCM)	10:4K60Hz(Y420)_3D_6CH
12:4K60HZ_3D_2CH	13:4K60HZ_3D_6CH
15:1080P_2CH(PCM)_HDR	16:1080P_6CH_HDR
18:1080P_3D_2CH(PCM)_HDR	19:1080P_3D_6CH_HDR
21:4K30Hz_3D_2CH(PCM)_HDR	22:4K30Hz_3D_6CH_HDR
24:4K60Hz(Y420)_3D_2CH(PCM)_HDR	25:4K60Hz(Y420)_3D_6CH_HDR
27:4K60Hz_3D_2CH(PCM)_HDR	28:4K60Hz_3D_6CH_HDR
30:FRL10G_8K_2CH_HDR	31:FRL10G_8K_6CH_HDR
33:USER1_EDID	34:USER2_EDID
	35:USER3_EDID
SET INx EDID CY OUTy	: Copy Output y EDID To Input x(USER1 BUF){x=[0~8](0=ALL), y=[1~8]}
SET INx Uy EDID CY OUTz	: Copy Output z EDID To User y Buff Input x{x=[0~8](0=ALL), y=[1~3],z=[1~8]}
SET INx EDID Uy DATAz	: Write EDID To User y Buffer of Input x{x=[0~8](0=ALL), y=[1~3],z=[EDID Data]}
SET INx EXMX MODEy	: SET Input x Ex-Audio DSP Matrix Mode y{x=[0~8](0=ALL),y=Matrix Mode[0-7], Mode:[0-Matrix Mode Close],[1-STD FX,Default Mode],[2-Low Center+],[3-Mid Center+],[4-High Center+],[5-Middle FX],[6-Full FX],[7-Voice FX]}
SET INx DDRC MODEy	: SET Input x Ex-Audio DSP Dolby DRC Modey {x=[0~8](0=ALL),y=DRC Mode[0-2]:[1-DRC OFF],[2-DRC ON],[3-DRC Auto]}
SET INx EAUD VVy	: Set Input x Ex-Audio Volume Value y {x=[0~8](0=All),y=[0-100]}
SET INx TMDS ON/OFF	: Set Input x Port TMDS Status ON/OFF{x=[0~8](0=ALL)}
GET INx EDID	: Get Input x EDID Index{x=[0~8](0=ALL)}
GET INx EDID y DATA	: Get Input x EDID y Data{x=[1~8],y=[0~32]}
GET INx EXMX MODE	: GET Input x Ex-Audio DSP Matrix Mode Status{x=[0~8](0=ALL)}
GET INx DDRC MODE	: GET Input x Ex-Audio DSP Dolby DRC Mode Status{x=[0~8](0=ALL)}
GET INx EAUD VV	: Get Input x Ex-Audio Volume Value Status{x=[0~8](0=All)}
GET INx TMDS	: Get Input x Port TMDS Status{x=[0~8](0=ALL)}
Network Setup Command:	
	: (xxx=[000-255], zzzz=[0001~9999]
SET RIP xxx.xxx.xxx.xxx	: Set Route IP Address to xxx.xxx.xxx.xxx
SET HIP xxx.xxx.xxx.xxx	: Set Host IP Address to xxx.xxx.xxx.xxx
SET NMK xxx.xxx.xxx.xxx	: Set Net Mask to xxx.xxx.xxx.xxx
SET TIP zzzz	: Set TCP/IP Port to zzzz
SET DHCP y	: Set DHCP {y=[0~1](0=Dis,1=Enable)}
GET RIP	: Get Route IP Address
GET HIP	: Get Host IP Address
GET NMK	: Get Net Mask
GET TIP	: Get TCP/IP Port
GET DHCP	: Get DHCP Status
GET MAC	: Get MAC Address

Command List Continued

RS232 Route Setup Command:

SET RS PTH OUTx LENy BRz	: Set RS232 Control Pass Through to Outputx {x=[0-8](0=ALL),y=[1~800],z=[0~5](0=9600,1=14400,2=19200,3=38400,4=57600,5=115200)}
--------------------------	---

IR Code Setup:

SET IR SYS xx.yy	: Set IR System Code {xx=[00~FFH],yy=[00~FFH]}
SET IR OUTx INy CODE mm.nn	: {x=[1~8],y=[1~8],mm=[00~FFH,Output],nn=[00~FFH,Input]}
SET IR SWMD x	: Set IR Switch Mode x{x=[0-1],0-Left or Right Switch,1-Output Select The Input}
GET IR SYS	: Get IR Custom Code
GET IR OUTx INy CODE	: Get IR Data Code{x=[1~8],y=[1~8]}
GET IR SWMD	: Get IR Switch Mode Status

Extracted Audio

The extracted audio ports have three distinct operating modes. Your desired mode can be set to suite your particular installation.

The 3 modes are:

Bind to Input ~ This is the default configuration. In this mode the audio port number corresponds to the INPUT signal. This is ideal for systems where audio is matrixed separately in a zoned amplifier.

Bind to Output ~ This configuration will automatically have the audio follow OUTPUT, so the audio from the extracted port always matches the HDMI output. This is ideal for systems that use local AVR's for some of the zones.

Independent/Matrix ~ This mode allows you matrix the extracted audio outputs independent of HDMI. In this mode a new set of commands becomes available to be able to route audio however you want. This can be used as a separate zoned audio matrix with only using an amplifier.

Setting up Extracted Audio Routing:

You can set up Extracted Audio Routing from the front panel, WebUI, Driver or by sending the following command:

SET EXAMX MODE x -- Where $\{x=[0\sim 2]\}$ (0=Bind To Output,1=Bind To Input,2=Matrix)

If you set to "Matrix" you can use the following command to route the 16 extracted audio ports to any INPUT:

SET OUT x AS IN y -- Where Set Ex-Audio Output x To Input y $\{x=[0\sim 4]\}$ (0=ALL), $y=[1\sim 4]\}$

Balanced 5 pin 2Ch and Toslink Audio Port /SPDIF:

The SPDIF Toslink port supports up to 5.1 Ch Digital audio the balanced 5 pin terminal connector supports 2 Ch audio only. This means in order for these ports to function the sources must be set to 2 Ch PCM, this unit does NOT down mix the audio (see AC-AXION-4 for down-mixing matrix). To get more than 2 Channels you will want to use the SPDIF port.

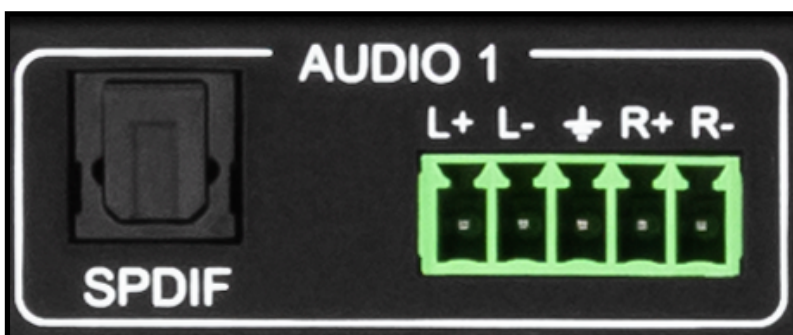

Audio Output Logic and Cable Prep

You can extract audio from Toslink or balance 2CH Audio.

2CH Balanced Audio Port - Supports 2CH PCM audio only, which is ideal for 2 Channel systems and zoned audio systems. No Down-mixing on this version, see AC-AXION-4.

Toslink Audio Port - Toslink extracted audio ports support up to 5.1 digital audio.

You can use balanced analog outputs in a balanced system, but you can also prep a cable as shown below to convert to a traditional 2CH unbalanced (L/R) system. You can also purchase pre-made cables (AC-CABLE-5PIN-2CH) four of these are included in the box when purchased.

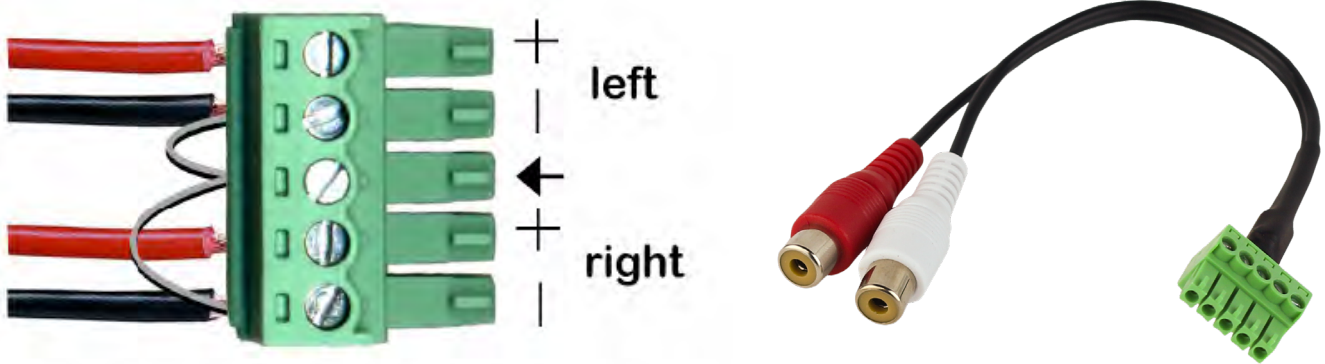

AUDIO CONNECTION DIAGRAM

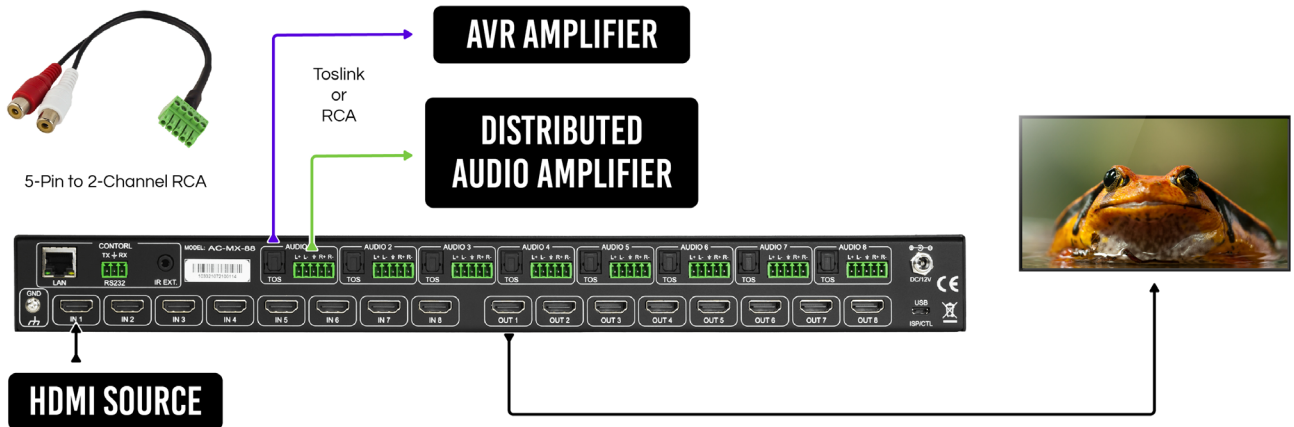

Troubleshooting

- Verify Power - Check that the power supply is properly connected and on an active circuit.
- Verify Connections - Check that all cables are properly connected.
- Use the System section of the WebUI to verify the matrix firmware is up to date - Page(s) [25-26](#)
- Use the Diagnostics section of the WebUI to verify the HDMI Input/Output status and EDID settings. Page(s) [27-29](#).
- Diagnostics page indicates everything is good but still not getting a picture, this may be a bandwidth limitation. See Bandwidth Chart on pages [42](#) and [43](#) to verify the signal is not exceeding the bandwidth of any of the devices in the chain.
- Still experiencing issues, contact our technical support for further assistance

1-877-886-5112

605-274-6055

support@avproedge.com

Bandwidth Chart

				HDR (10 & 12 BIT ONLY)	BANDWIDTH UNCOMPRESSED	BANDWIDTH COMPRESSED (DSC)
FHD	1920 x 1080 100-120p	4:4:4	8 Bit		9 Gbps	N/A
		4:4:4	10-12 Bit	X	18 Gbps	N/A
		4:2:2	8-12 Bit	X	9 Gbps	N/A
	3840 x 2160 & 4096 x 2160 24-30p	4:4:4	8 Bit		9 Gbps	N/A
		4:4:4	10-12 Bit	X	18 Gbps	N/A
		4:2:2	10-12 Bit	X	9 Gbps	N/A
UHD & 4K	3840 x 2160 & 4096 x 2160 48-60p	4:4:4	8-12 Bit	X	18 Gbps	9 Gbps
		4:2:2	8-12 Bit	X	18 Gbps	9 Gbps
		4:2:0	8 Bit		9 Gbps	9 Gbps
	4:2:0	10-12 Bit	X	18 Gbps	9 Gbps	
	3840 x 2160 100-120p	4:4:4	8 Bit		32 Gbps	18 Gbps
		4:4:4	10 Bit	X	40 Gbps	18 Gbps
4:4:4		12 Bit	X	48 Gbps	18 Gbps	
4:2:2		8-12 Bit	X	32 Gbps	9 Gbps	
4:2:0		8 Bit		18 Gbps	9 Gbps	
4:2:0		10-12 Bit	X	24 Gbps	9 Gbps	
4096 x 2160 100-120P	4:4:4	8 Bit		32 Gbps	18 Gbps	
	4:4:4	10 Bit	X	40 Gbps	18 Gbps	
	4:4:4	12 Bit	X	48 Gbps	18 Gbps	
	4:2:2	8-12 Bit	X	32 Gbps	18 Gbps	
	4:2:0	8 Bit		18 Gbps	9 Gbps	
	4:2:0	10-12 Bit	X	24 Gbps	9 Gbps	
5K	5120 x 2160 24-30p	4:4:4	8-12 Bit		18 Gbps	N/A
		4:2:2	8-12 Bit		18 Gbps	N/A
	5120 x 2160 48-60p	4:4:4	8 Bit		24 Gbps	9 Gbps
		4:4:4	10-12 Bit		32 Gbps	9 Gbps
		4:2:2	8-12 Bit		24 Gbps	9 Gbps
	5120 x 2160 100-120p	4:2:0	8-12 Bit		18 Gbps	9 Gbps
		4:4:4	8 Bit		40 Gbps	18 Gbps
		4:4:4	10-12 Bit		N/S	18 Gbps
	5120 x 2160 100-120p	4:2:2	8-12 Bit		40 Gbps	18 Gbps
		4:2:0	8 Bit		24 Gbps	18 Gbps
		4:2:0	10-12 Bit		32 Gbps	18 Gbps

Bandwidth Chart Continued

				HDR (10 & 12 BIT ONLY)	BANDWIDTH UNCOMPRESSED	BANDWIDTH COMPRESSED (DSC)	
8K	7680 x 4320 24-30p	4:4:4	8 Bit		32 Gbps	18 Gbps	
		4:4:4	10 Bit	X	40 Gbps	18 Gbps	
		4:4:4	12 Bit	X	48 Gbps	18 Gbps	
		4:2:2	8-12 Bit	X	32 Gbps	9 Gbps	
		4:2:0	8 Bit		18 Gbps	9 Gbps	
		4:2:0	10-12 Bit	X	24 Gbps	9 Gbps	
	7680 x 4320 48-60p	4:4:4	8-12 Bit	X	N/S	24 Gbps	
		4:2:2	8-12 Bit	X	N/S	18 Gbps	
		4:2:0	8 Bit		32 Gbps	18 Gbps	
		4:2:0	10 Bit	X	40 Gbps	18 Gbps	
		4:2:0	12 Bit	X	48 Gbps	18 Gbps	
		7680 x 4320 100-120p	4:4:4	8-12 Bit	X	N/S	40 Gbps
4:2:2	8-12 Bit		X	N/S	40 Gbps		
4:2:0	8-12 Bit		X	N/S	32 Gbps		
10K	10240 x 4320 24-30p		4:4:4	8 Bit		40 Gbps	18 Gbps
			4:4:4	10-12 Bit		N/S	18 Gbps
			4:2:2	8-12 Bit		40 Gbps	18 Gbps
	10240 x 4320 48-60p	4:2:0	8 Bit		24 Gbps	9~24-25p, 18~30p	
		4:2:0	10-12 Bit		32 Gbps	9~24-25p, 18~30p	
		4:4:4	8-12 Bit		N/S	32 Gbps	
10240 x 4320 100-120p	10240 x 4320 48-60p	4:2:2	8-12 Bit		N/S	24 Gbps	
		4:2:0	8 Bit		40 Gbps	18~48, 24~50/60	
		4:2:0	10-12 Bit		N/S	18~48, 24~50/60	
	10240 x 4320 100-120p	4:4:4	N/S		N/S	N/S	
		4:2:2	8-12 Bit		N/S	48 Gbps	
		4:2:0	8-12 Bit		N/S	40 Gbps	

As you can see each resolution, timing and color space has an uncompressed bandwidth and a compressed bandwidth. With the HDMI 2.1 specification, all HDMI sources will have the ability to send a compressed signal or an uncompressed signal, depending on what the EDID from the display is asking for. Employing DSC compression at the source will allow most resolutions to be under 24Gbps.

N/S = NOT SUPPORTED

Maintenance

To ensure reliable operation of this product as well as protecting the safety of any person using or handling this device while powered, please observe the following instructions.

- Use the power supplies provided. If an alternate supply is required, check voltage, polarity and that it has sufficient power to supply the device it is connected to.
- Do not operate these products outside the specified temperature and humidity range given in the above specifications.
- Ensure there is adequate ventilation to allow this product to operate efficiently.
- Repair of the equipment should only be carried out by qualified professionals as these products contain sensitive components that may be damaged by any mistreatment.
- Only use this product in a dry environment. Do not allow any liquids or harmful chemicals to come into contact with these products.
- Clean this unit with a soft, dry cloth. Never use alcohol, paint thinner or benzene to clean this unit.

Damage Requiring Service

The unit should be serviced by qualified service personnel if:

- The DC power supply cord or AC adapter has been damaged
- Objects or liquids have gotten into the unit
- The unit has been exposed to rain
- The unit does not operate normally or exhibits a marked change in performance
- The unit has been dropped or the housing damaged

Support

Should you experience any problems while using this product, first, refer to the Troubleshooting section of this manual before contacting Technical Support. When calling, the following information should be provided:

- Product name and model number
- Product serial number
- Details of the issue and any conditions under which the issue is occurring
- Clean this unit with a soft, dry cloth. Never use alcohol, paint thinner or benzene to clean this unit.

Warranty

THE BASICS.

AVPro Edge warrants its products that are purchased from all Authorized AVPro Edge Resellers or direct purchases. Products are guaranteed to be free from manufacturing defects and of sound physical and electronic condition.

AVPro Edge has developed a warranty that anyone can get behind. We really wanted to take all the "red tape" out of a warranty and just make it simple. Our 10 YEAR NO BS warranty hinges on 3 elements.

1. If you are having trouble, call us. We will attempt to troubleshoot your issue over the phone.
2. If it's broke - We'll replace it in advance on our dime. (We'll cover return shipping too.) Repair is an option too, but it's YOUR call.
3. We know you know what you are doing. We will not make you go through unnecessary steps to troubleshoot an extender...

COVERAGE DETAILS.

AVPro Edge will replace or repair (at customer choice) the defective product. If the product is out of stock or on back order it can either be replaced with a comparable product of equal value/feature set (if available) or repair.

Your warranty begins at receipt of product (as confirmed by shipping firm tracking). If tracking information is unavailable for any reason, the warranty will commence 30 ARO (After Receipt of Order). The coverage continues for 10 YEARS.

RED TAPE.

AVPro Edge is not responsible for untraceable purchases or those that were made outside of an authorized channel.

If we conclude that a product or serial number has been tampered with as identified by warranty seal or physical examination the warranty will be void. Additionally, excessive physical damage (beyond normal wear & tear) the warranty may be voided or prorated based on the extent of the damage as examined by an AVPro Edge representative.

Damage caused by "acts of God" are not covered. They can include natural disasters, power surges, storms, earthquakes, tornadoes, sink holes, typhoons, tidal waves, hurricanes, or any other uncontrollable event related to nature.

Damage caused by incorrect installation will not be covered. Incorrect power supply, inadequate cooling, improper cabling, inadequate protection, static discharge are examples of this.

Products installed or sold by a third party to AVPro Edge will be serviced by the Authorized AVPro Edge Reseller.

Accessories (IR Cables, RS-232, Power Supplies, etc...) are not included in the warranty. We will make acceptable effort to source and supply replacements for defective accessories at a discounted rate as needed.

OBTAINING AN RMA.

Dealers, Re-sellers, and Installers can request an RMA AVPro Edge Tech Support Rep or their Sales Engineer. Or you may email support@avproedge.com or fill out the general contact form at www.avproedge.com

End users may not request and RMA directly from AVPro Edge and will be referred back to the Dealer, Re-seller or Installer.

SHIPPING.

For USA (not including Alaska and Hawaii). Shipping is covered on advanced replacements for FedEx Ground (some expressed exceptions may apply). Defective product return shipping is covered by AVPro Edge using an emailed return label. Item must be returned within 30 days of receipt of replacement product, after 30 days, the customer will be billed. Other return shipping methods will not be covered.

For International (and Alaska and Hawaii) return shipping costs will be the responsibility of the returnee. Once the unit is scanned for return shipping AVPro Edge will ship new unit for replacement.

LEGAL STUFF.

Limitation on Liability

The maximum liability of AVPro Global Holdings LLC under this limited warranty shall not exceed the actual purchase price paid for the product. AVPro Global Holdings LLC is not responsible for direct, special, incidental or consequential damages resulting from any breach of warranty or condition, or under any other legal theory to the maximum extent permitted by law.

Taxes, Duties, VAT, and freight forwarding service charges are not covered or paid for by this warranty.

Obsolescence or incompatibility with newly invented technologies (after manufacture of product) is not covered by this warranty.

Obsolescence is defined as:

“Peripherals are rendered obsolete when current technology does not support product repair or re-manufacture. Obsolete products cannot be re-manufactured because advanced technologies supersede original product manufacturer capabilities. Because of performance, price and functionality issues, product redevelopment is not an option.”

Discontinued or out of production items will be credited at fair market value towards a current product of equal or comparable capabilities and cost. Fair market value is determined by AVPro Edge.

Exclusive Remedy

To the maximum extent permitted by law, this limited warranty and the remedies set forth above are exclusive and in lieu of all other warranties, remedies and conditions, whether oral or written, express or implied. To the maximum extent permitted by law, AVPro Global Holdings LLC specifically disclaims any and all implied warranties, including, without limitation, warranties of merchantability and fitness for a particular purpose. If AVPro Global Holdings LLC cannot lawfully disclaim or exclude implied warranties under applicable law, then all implied warranties covering this product, including warranties of merchantability and fitness for a particular purpose, shall apply to this product as provided under applicable law.

This warranty supersedes all other warranties, remedies and conditions, whether oral or written, express or implied.

Thank you for choosing AVProEdge!

Please contact us with any questions, we are happily at your service!



AVProEdge
2222 E 52nd St N ~ Sioux Falls, SD 57104

1-877-886-5112 ~ 605-274-6055
support@avproedge.com