

MODEL : SB-5669LCM
16x16 HDMI MATRIX ROUTING SWITCHER



**16x16 HDMI Matrix Routing Switcher w/ Full EDID
Management/Learning 4k2k Capable**



HDMI Matrix Routing Switcher Series

Thank you for purchasing the SB-5669LCM 16x16 HDMI Matrix Routing Switcher. You will find this unit easy to install and highly reliable but it is essential that you read this manual thoroughly before attempting to use 16x16 HDMI Matrix Routing Switcher.



SAFETY INFORMATION



1. To ensure the best results from this product, please read this manual and all other documentation before operating your equipment. Retain all documentation for future reference.
2. Follow all instructions printed on unit chassis for proper operation.
3. To reduce the risk of fire, do not spill water or other liquids into or on the unit, or operate the unit while standing in liquid.
4. Make sure power outlets conform to the power requirements listed on the back of the unit. Keep unit protected from rain, water and excessive moisture.
5. Do not attempt to clean the unit with chemical solvents or aerosol cleaners, as this may damage the unit. Dust with a clean dry cloth.
6. Do not use the unit if the electrical power cord is frayed or broken. The power supply cords should be routed so that they are not likely to be walked on or pinched by items placed upon or against them, paying particular attention to cords and plugs, convenience receptacles, and the point where they exit from the appliance.
7. Do not force switched or external connections in any way. They should all connect easily, without needing to be forced.
8. Always operate the unit with the AC ground wire connected to the electrical system ground. Precautions should be taken so that the means of grounding of a piece of equipment is not defeated.
9. AC voltage must be correct and the same as that printed on the rear of the unit. Damage caused by connection to improper AC voltage is not covered by any warranty.
10. Turn power off and disconnect unit from AC current before making connections.
11. Never hold a power switch in the "ON" position.
12. This unit should be installed in a cool dry place, away from sources of excessive heat, vibration, dust, moisture and cold. Do not use the unit near stoves, heat registers, radiators, or other heat producing devices.
13. Do not block fan intake or exhaust ports. Do not operate equipment on a surface or in an environment which may impede the normal flow of air around the unit, such as a bed, rug, carpet, or completely enclosed rack. If the unit is used in an extremely dusty or smoky environment, the unit should be periodically "blown free" of foreign dust and matter.
14. To reduce the risk of electric shock, do not remove the cover. There are no user serviceable parts inside. Refer all servicing to qualified service personnel. There are no user serviceable parts inside.
15. When moving the unit, disconnect input ports first, then remove the power cable; finally, disconnect the interconnecting cables to other devices.
16. Do not drive the inputs with a signal level greater than that required to drive equipment to full output.
17. The equipment power cord should be unplugged from the outlet when left unused for a long period of time.
18. Save the carton and packing material even if the equipment has arrived in good condition. Should you ever need to ship the unit, use only the original factory packing.
19. Service Information Equipment should be serviced by qualified service personnel when:
 - A. The power supply cord or the plug has been damaged.
 - B. Objects have fallen, or liquid has been spilled into the equipment.
 - C. The equipment has been exposed to rain
 - D. The equipment does not appear to operate normally, or exhibits a marked change in performance
 - E. The equipment has been dropped, or the enclosure damaged.

TABLE OF CONTENTS

CONTENTS

INTRODUCTION	1
FEATURES	2
SPECIFICATIONS	3
FRONT PANEL	4
REAR PANEL	7
REMOTE CONTROL	8
EDID FUNCTIONS	10
TYPICAL APPLICATION	15
IR EXTENDER	17
ETHERNET PROTOCOL	18
RS-232 PROTOCOL	19
LIMITED WARRANTY	20

INTRODUCTION

The SB-5669LCM is high-performance 16x16 matrix routing switcher for HDMI signals. This switcher supports data rates up to 6.75 Gbps, enabling 4K2K HDMI formats and UXGA/WUXGA/DVI HD resolution 1920x1200 to any HD display. High Definition Digital signals can be selected and distributed to any 16 outputs simultaneously. The Switcher is certified as being fully HDMI and HDCP compliant, with RoHS, CE, FCC certification. Support high resolution HDMI sources routed to HDMI displays, monitors, and projector or audio receivers. The EDID can be selected between seven (7) different modes. Control is provided via Front panel push buttons, IR remote, RS-232 or TCP/IP (not a web-browser). An RS-232 / TCP-IP Windows GUI interface is provided for matrix routing.

PACKAGE CONTENTS

Check that you have the following components;

- SB-5669LCM Matrix Routing Switcher
- IR remote controller (SW-5669)
- 19-inch ear mount bracket (Part # 2U-440L)
- IR extender SB-100 receiver (300M length)
- IR extender SB-100C receiver (2M length)
- 32x HDMI connector use ISO screw(L5mm/OD3mm)
- CD contents: Windows GUI
- RS-232 Cable
- Users Guide
- Power Supply: Universal Type 50/60Hz, 110~240 VAC



SAFETY PRECAUTIONS

Please read all instructions before attempting to unpack, install or operate this equipment and before connecting the power supply. Please keep the following in mind as you unpack and install this equipment:

- Always follow basic safety precautions to reduce the risk of fire, electrical shock and injury to persons.
- To prevent fire or shock hazard, do not expose the unit to rain, moisture or install this product near water.
- Never spill liquid of any kind on or into this product.
- Never push an object of any kind into this product through any openings or empty slots in the unit, as you may damage parts inside the unit.
- Do not attach the power supply cabling to building surfaces.
- Use only the supplied power supply unit (PSU). Do not use the PSU if it is damaged.
- Do not allow anything to rest on the power cabling or allow any weight to be placed upon it or any person walk on it.
- To protect the unit from overheating, do not block any vents or openings in the unit housing that provide ventilation and allow for sufficient space for air to circulate around the unit.

DISCLAIMERS

The information in this manual has been carefully checked and is believed to be accurate. We assume no responsibility for any infringements of patents or other rights of third parties which may result from its use.

We assume no responsibility for any inaccuracies that may be contained in this document. We make no commitment to update or to keep current the information contained in this document.

We reserve the right to make improvements to this document and/or product at any time and without notice.

COPYRIGHT NOTICE

No part of this document may be reproduced, transmitted, transcribed, stored in a retrieval system, or any of its part translated into any language or computer file, in any form or by any means — electronic, mechanical, magnetic, optical, chemical, manual, or otherwise — without express written permission and consent

© Copyright 1997. All Rights Reserved.

Version 2.2 NOV 2013

TRADEMARK ACKNOWLEDGMENTS

All products or service names mentioned in this document may be trademarks of the companies with which they are associated.

FEATURES

FEATURES

- Enables switching of 16x HDMI digital source devices to 16x HDMI devices.
- HDMI digital video w/embedded audio, DVI format and HDCP 2.2 compliant.
- Seven (7) function button control and worldwide (7) EDID modes for HDTV 4K2K resolutions.
- Link speeds of up to 6.75 Gbps (link clock rate of 340Mb Hz), support HDMI 1.4a 3D formats.
- Wide range of HD resolutions from PC DVI XGA to WUXGA 1920x1200 and support HDTV/DTV resolutions 480i/480p, 576i/576p, 720p, 1080i & 1080p, 4K2K (3860x2160).
- Compatible with all HDMI source devices, PC monitors, plasma HD display, HDTV and audio receivers/amplifiers.
- Digital Video TMDS formats resolution up to 1080p-60 with deep color 36-bit.
- Digital Audio Support :
 - Dolby TrueHD, Dolby Digital, Dolby Digital Plug/ex, DTS, DTS-HD, DTS-HD Master, DTS-EX PCM, PCM2, LPCM2
- Various user interface controls:
 - Windows-based GUI control via RS-232 port
 - Front panel push buttons
 - IR wireless remote control
 - Third party RS-232 controller (via simple ASCII)
 - ETHERNET series interface (via pc protocol commands)
- Supports worldwide control functions: ALL/OFF/RECALL/ENTER/MEMORY/EDID/LOCK.
- Support EDID modes :
 - Embedded EDID modes :
 - FSS (fast start speed)
 - H24-3D
 - H24-3D-M (multi Audio)
 - H36-3D
 - H36-3D-M (multi Audio)
 - 4K2K-3D PCM 2CH
 - DVI-D 1920x1200-60Hz
 - External modes : Learning mode (learning destination EDID link to source device).
- Automatic scanning of input & output status and display via LCM front panel.
- Supports IR Remote and IR Extender with maximum distance up to ~ 1000 ft. (300M).
- EDID configuration via internal modes.

SPECIFICATIONS

SPECIFICATIONS

- **Type of HDMI Switcher:** 16x HDMI inputs to 16x HDMI outputs matrix switcher
- **HDMI Support:** HD 1080p-@60Hz, 4K2K, H36-bit deep color, 3D (1.4a) formats
- **HDCP Support:** HDCP 2.2 Compliant
- **Video Bandwidth:** Double Data Rates:340 MHz, total 6.7 Gbps bandwidth
- **Digital Video Support:** Full HD resolution : 480i / 480p / 720p / 1080i / 1080p / 4K2K
- **Digital Audio Support:**
 - Multi Audio Formats 5.1 / 7.1, MAT(MLP)
 - Dolby Digital,
 - Dolby TrueHD,
 - Dolby Digital Plus,
 - DTS, DTS-ES 6.1,
 - DTS-HD, DTS-HD-HRA, DTS-HD Master,
 - (PCM-2CH)
- **Switcher Controls:**
 - IR remote control
 - IR external port x 1 (OD 3.5mm ear phone jack)
 - Front panel buttons
 - Ethernet and RS-232 serial interface
- **Source Status:** Automatic scanning of input status and display via LCM panel
- **Function Control Key:** ALL / OFF / RECALL / ENTER / MEMORY / LOCK / EDID
- **Infrared Frequency:** 38 KHz
- **IR Extend Distance:** SB-100 (1000 feet / 300 meters maximum), SB-100C(2M)
- **HDMI I/O Connector:** HDMI Type A - SMD 19-pin female type
- **Temperature:** Operate in a place between 32°F - 100°F (0°C - 38°C)
- **Dimensions (LxWxH):** 17.3 x 11.9 x 3.5 in (442mm x 303mm x 88mm)
- **Rack Mount:** 2RU High 19 "rack mount (with rack mount ears) #2U-440L
- **Power Supply:** universal / worldwide type 50/60Hz, 110~240 VAC(120W)
- **Unit Material:** Metal (thin 1mm)
- **Safety Approvals:** CE, FCC, RoHS (2002/95/EC), REACH
- **Product Weight:** 4 Kgs / 8.82 lb

As product improvements are continuous, specifications are subject to change without notice.

FRONT PANEL

FRONT PANEL

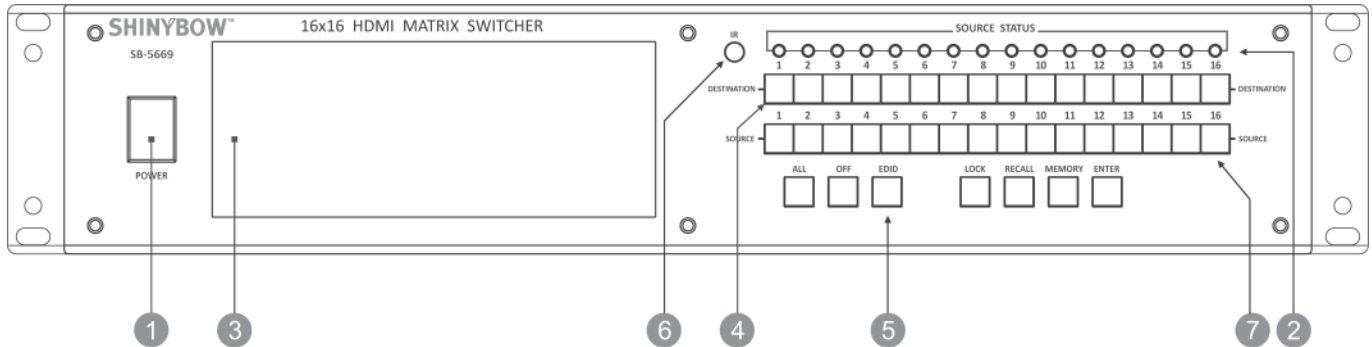

1. POWER ON SWITCH

The power switch turns the unit on and off. The LCM will illuminate blue to indicate the switcher is ON and receiving power. The switcher will remember the last setting during a power cycle. When power is removed and resorted, the last configuration will be evoked.

2. INPUT STATUS DISPLAY

Input source 1 to 16 LED illuminate white to indicate a video source is present on that input.

3. OUTPUT STATUS DISPLAY

Each output (destination) channel shows which input (source) is assigned via LCM display.

4. DESTINATION SELECT BUTTONS

Separate outputs 1 thru 16 select buttons are provided for each destination assignment.

Routing can be Source to Destination or one source to multiple destinations.

Example: Press Destination 1, 3, 5, then press Source 2. The switcher will route Input 2 to Output 1,3,5 respectively.

5. EDID MODE SELECT BUTTONS

Use button #1 and #2 to select the desired EDID mode.

6. IR SENSOR

The IR sensor receives IR commands from the supplied remote controller or a third party IR emitter.

7. SOURCE SELECT BUTTONS

Input 1 thru 16 buttons are provided for each source selection.

FRONT PANEL

FRONT PANEL

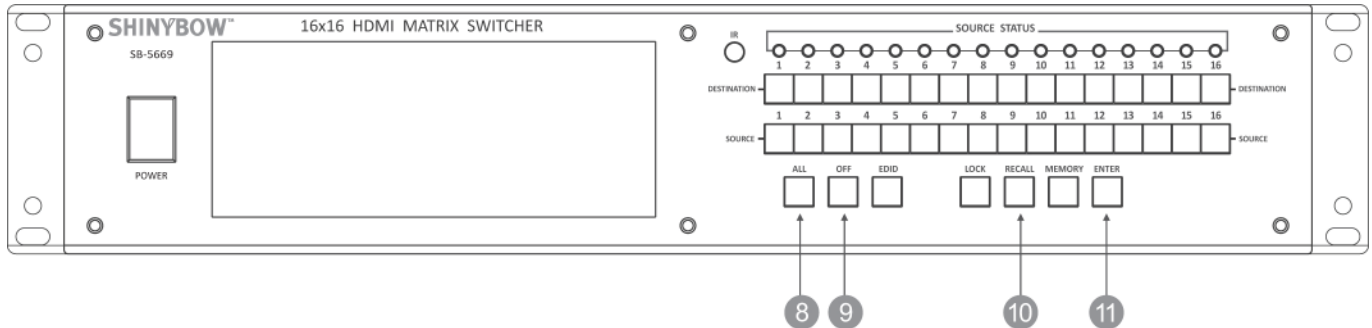

8. FUNCTION KEY - ALL



Disables (mute) video on all destinations OR assign the same source to all destinations.

Option 1

- Press **ALL** followed by **OFF** button. The display will show "0" to indicate none of the destinations are assigned a video source.

Option 2

- Press **ALL** followed by Source 1 thru 16. The display will show the source selected.
- Press **ENTER**. The pre-set source selection will be assigned all destinations.

9. FUNCTION KEY - OFF



Disables (mute) video on the selected destinations.

- Press **OFF** button followed by any Destination channel.
- Press 1 thru 16 output destination. The display will show "0" for the selected channel, indicating no video selected.

10. FUNCTION KEY - RECALL

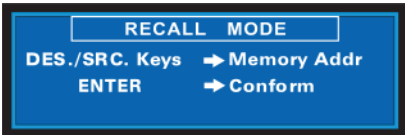

The system can save up to 16 sets of learning routes, which are stored in local memory using Source buttons 1 thru 16 and Destination buttons 1 thru 16 as the memory preset location.

- Press **RECALL** button.
- Press 1 thru 16 on either Source or Destination row.
- Press **ENTER**. The pre-set configuration will execute.

Operation completes.

Note: Operation will abort if no keys are dressed within 5 seconds.

11. FUNCTION KEY - ENTER

Press **ENTER** to confirm entries.

FRONT PANEL

FRONT PANEL

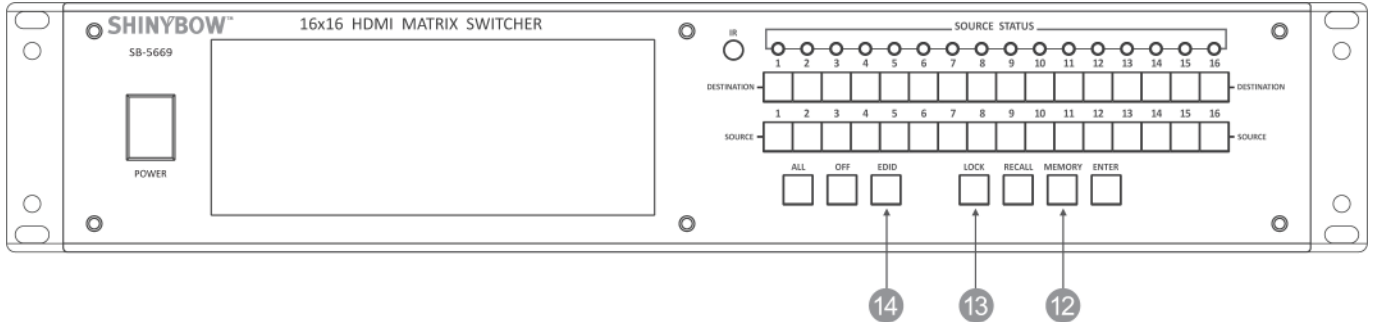

12. FUNCTION KEY - MEMORY

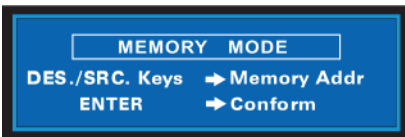

The system can save up to 16 sets of switching routes, which are stored in local memory using Source keys 1 thru 16 or Destination buttons 1 thru 16 as the memory location.

- Configure desired matrices .
- Press **MEMORY** button.
- Press 1 thru 16 on either Source or Destination row.
- Press **ENTER** to ready memory location.
- Or press **MEMORY** again to cancel operation.

Operation completes.

Note: Operation will abort if no keys are dressed within 5 seconds.

13. FUNCTION KEY - LOCK



- Press and hold **LOCK** button for two seconds lock out the front panel (as shown on the left).
- Press and hold **LOCK** button for two seconds to enable the front panel (as shown on the right).

14. FUNCTION KEY - EDID

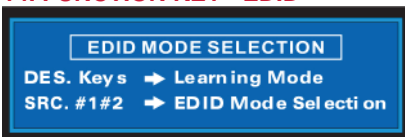

- Press EDID to begin setting up your EDID mode. Use source row buttons #1 and #2 to cycle thru the options. (Go to page 7 ~ 13 for EDID setup instruction.)

BACK PANEL

BACK PANEL

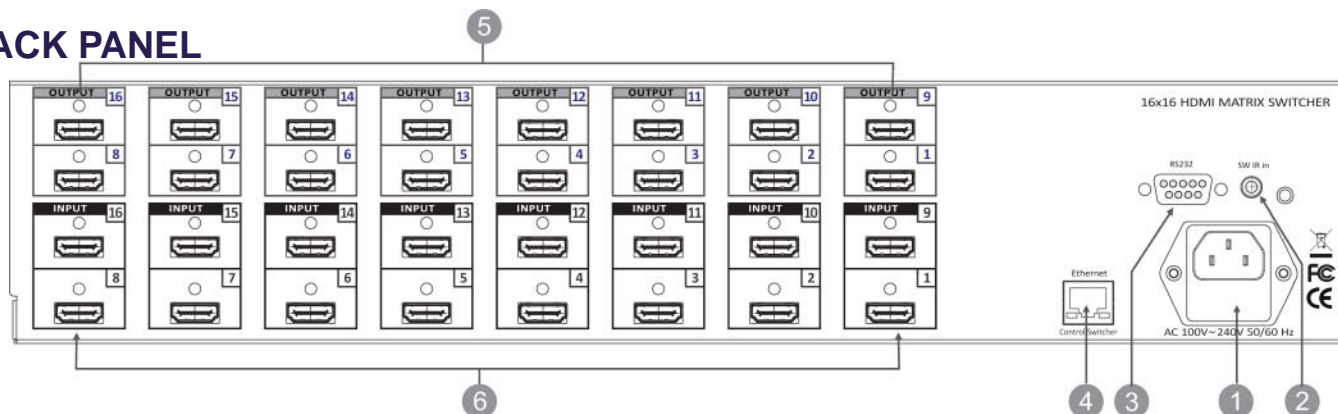

1. DC POWER INLET:

The switcher is fitted with a DC power plug input connector. Ensure that the used is of an approved type and is of sufficient current carrying connector capacity with the correct voltage and connector polarity. Power supply 100V~240VAC, 50/60Hz.



Power Jack:

DC Jack - Inner OD Ø 2.1 mm (+)
Outside OD Ø 5.5mm (GND)
Power input -100V~240VAC,50/60Hz

2. IR EXTENDER CONTROL:

Support one of IR Extender Extend distance maximum 300m / ~1000 ft. When you plug the external IR extender into the switcher, the front panel IR receiver remains active.



IR Extender Jack: Female Jack - inner OD Ø 3.5mm

3. RS-232 CONNECTION:

RS-232 control port to allow for interfacing to a PC, such as a computer or touch panel control, to the switcher via this DB-9pin female connector for serial RS-232 control.

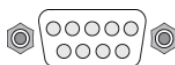

Remote port: DB-9pin Female connector

4. ETHERNET CONNECTION:

Connect a CAT6/6a/7 category cable to the Ethernet port for control of the switcher from a computer.

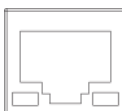

8P8C / RJ 45 connector

5. HDMI INPUTS 1 ~ 16:

Connect a signal link of HDMI direct digital video/audio to this female HDMI connector, which supports HDMI digital video/audio and DVI digital video sources.



HDMI digital video/audio connector:

HDMI Female connector.

Note: With proper adapters, the switcher can be used with DVI digital video signals, HDCP compliant.

HDMI Digital Video/Audio, Connector with fix screw
Input 1 ~ Input 16

6. HDMI OUTPUTS 1 ~ 16:

Connect a signal link of HDMI direct digital video/audio to this female HDMI connector, which supports HDMI digital video/audio and DVI digital video sources.



HDMI digital video/audio connector:

HDMI Female connector.

Note: With proper adapters, the switcher can be used with DVI digital video signals, HDCP compliant.

HDMI Digital Video/Audio, Connector with fix screw
Output 1 ~ Output 16

REMOTE CONTROL

Before making any connections to the switcher, observe the following:

- Ensure the mains voltage supply matches the label on the supplied plug- Pack (+/- 10%).
- Ensure that the power switch is OFF.
- Ensure that all system grounds (earth) are connected to a common point.
- Avoid powering equipment within a system from multiple power sources that may be separated by large distances.
- Connect all audio video sources and destination equipment.
- Power up all source and destination audio-visual sources.
- For each destination output, select the appropriate input source by using the front panel input 1~16 buttons, the supplied IR remote control, or through the RS-232 serial communication port.
- Upon power up the switcher will return to its last used setting before Powered down.

REMOTE CONTROL

IR REMOTE CONTROL KEY :

1. & 2. SWITCH POWER ON or OFF:

Controller with a power ON and OFF

3. DESTINATION : 1 thru 16 OUTPUT SELECTION:

Press the destination button to select the output display channel.

4. SOURCE : 1 thru 16 INPUT SOURCE SELECTION:

Press input 1~16 sources with selection button

5. FUNCTION KEY:

ALL - function selection button
OFF - function selection button
EDID - function selection button
RECALL - function selection button
ENTER - function selection button
MEMORY - function selection button
LOCK - function selection button

IR REMOTE : SW-5669

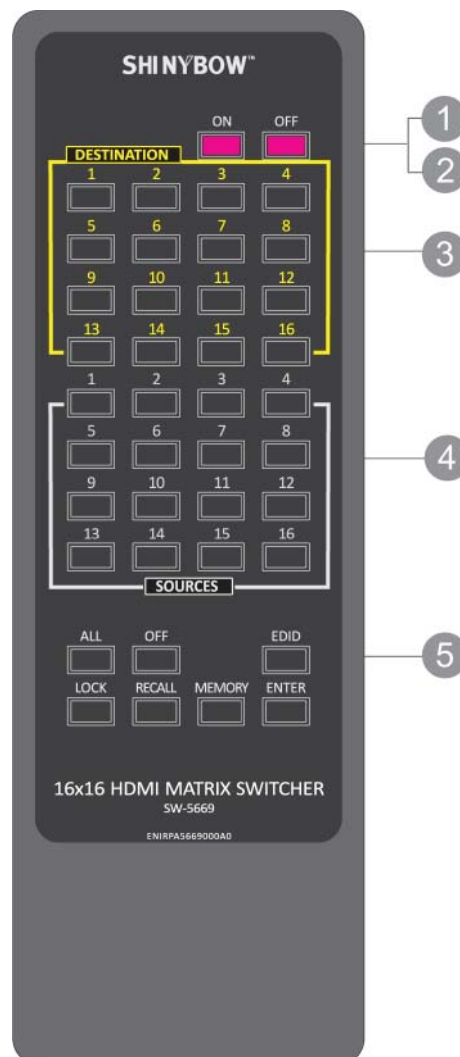

REMOTE PROTOCOL COMMANDS

IR REMOTE CUSTOM AND DATA CODES (NEC STANDARD)

HOW TO SETUP IR CODES :

CUSTOM CODE : 32CD

POWER ON : 32CD A15E
POWER OFF : 32CD A25D
ALL : 32CD B04F
OFF : 32CD B14E
LOCK : 32CD B54A
EDID : 32CD B748
RECALL : 32CD B24D
ENTER : 32CD B34C
MEMORY : 32CD B44B

HOW TO GIVE IR COMMANDS:

PRESS DESTINATION - # then PRESS SOURCE - #

DESTINATION #1 : 32CD 01FE	SOURCE #1 : 32CD 01FE
DESTINATION #2 : 32CD 11EF	SOURCE #2 : 32CD 21DE
DESTINATION #3 : 32CD 12ED	SOURCE #3 : 32CD 22DD
DESTINATION #4 : 32CD 13EC	SOURCE #4 : 32CD 23DC
DESTINATION #5 : 32CD 14EB	SOURCE #5 : 32CD 24DB
DESTINATION #6 : 32CD 15EA	SOURCE #6 : 32CD 25DA
DESTINATION #7 : 32CD 16E9	SOURCE #7 : 32CD 26D9
DESTINATION #8 : 32CD 13EC	SOURCE #8 : 32CD 27D8
DESTINATION #9 : 32CD 18E7	SOURCE #9 : 32CD 28D7
DESTINATION #10 : 32CD 19E6	SOURCE #10 : 32CD 29D6
DESTINATION #11 : 32CD 1AE5	SOURCE #11 : 32CD 2AD5
DESTINATION #12 : 32CD 1BE4	SOURCE #12 : 32CD 2BD4
DESTINATION #13 : 32CD 1CE3	SOURCE #13 : 32CD 2CD3
DESTINATION #14 : 32CD 10E2	SOURCE #14 : 32CD 2DD2
DESTINATION #15 : 32CD 1EE1	SOURCE #15 : 32CD 2ED1
DESTINATION #16 : 32CD 1FE0	SOURCE #16 : 32CD 2FD0

For example;







Let Destination # 1 show the signal from Source #1~4

The IR Data Code list :

Destination # 1 & Source #1	32CD 01FE 32CD 20DF
Destination # 1 & Source #2	32CD 01FE 32CD 21DE
Destination # 1 & Source #3	32CD 01FE 32CD 22DD
Destination # 1 & Source #4	32CD 01FE 32CD 23DC

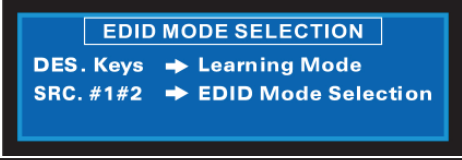
EDID FUNCTION

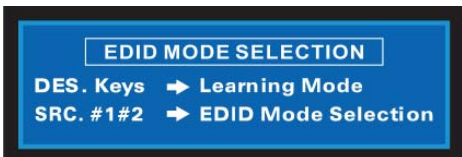
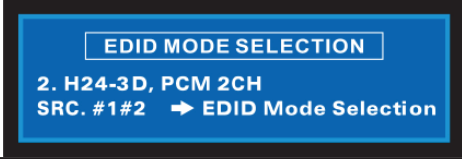
EDID FUNCTION SETUP

EDID Setup	How to enter and exit
<p>ENTER EXIT</p>  	<p>1. ENTER : After the switcher is turned on, the screen shows the main page. Press EDID to enter the EDID setup page.</p>
	<p>2. SELECT : When you enter, EDID mode selection will show on the top. DES is an abbreviation for destination while SRC for source.</p> <p>Pressing source keys 1 and 2 enable you to select the 8 EDID modes. (See page 11) Pressing destination keys will enter learning mode. (See page 12)</p>
	<p>3. EXIT : Press EDID again to exit. If you exit before ENTER is pressed, the setup will be cancelled.</p> <p>If the right bottom corner shows lock, it means the front panel buttons are all locked up. Pressing EDID when the panel is locked will not enter EDID setup page.</p>
EDID Setup	How to select an EDID mode
 <p>In the EDID setup page, pressing the source button 1 and 2 will cycle thru the available selections.</p> <p>Pressing source button 1 repeatedly to cycle UP.</p> <p>Pressing source button 2 repeatedly to cycle DOWN.</p> <p>A total of 8 embedded EDID modes are provided for selection. (See page 11)</p> <p>When the desired mode is displayed, press Enter to confirm that selection.</p> <p>The selected EDID mode will be applied to all destination and source devices.</p>	
	<p>1. Enter the EDID setup page and press source button 1 or 2 to cycle through the 8 embedded EDID modes.</p>
	<p>2. The left shows mode 2 as example. See the line 2. H24-3D, PCM 2 CH. To select the mode, press enter button.</p> <p>To go to next mode, press source 2.</p> <p>To return to previous mode, press source 1.</p>
<p>* Operation will abort if no buttons are pressed within 5 seconds.</p>	
View the current EDID mode	
<p>The lower left shows the currently selected EDID mode.</p> 	<p>The left shows the currently selected mode is mode 2, H24-3D, PCM 2 CH.</p>

EDID FUNCTION

EDID function : 7x Embedded EDID Modes

Mode 1. FSS (Fast Speed Start)

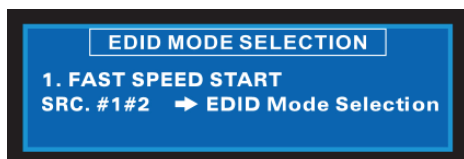

Fast Speed Start mode shortens the startup time of the switcher. Selecting this mode does not force the EDID setup to be cancelled. Users may first select one EDID mode from mode 2 to 8, and then select mode 1 for fast speed start.

Mode 2. H24-3D (1080p-24 bits)

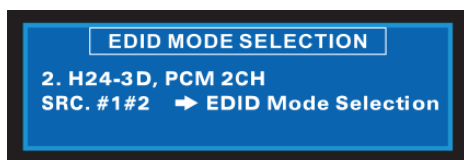

Audio Support: PCM 2CH

Mode 3. H24-3D-M (1080p-24 bits)

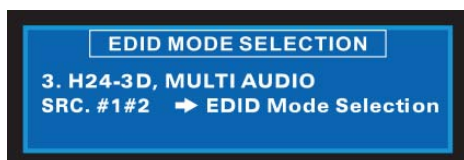

Audio Support: MAT(MLP) 7.1CH, PCM2CH, One Bit Audio 2CH, AC-3 5.1CH, DTS5.1CH, PCM7.1CH, Dolby Digital + 7.1CH, DTS-HD 7.1CH

Mode 4. H36-3D-M (1080p-36 bits)

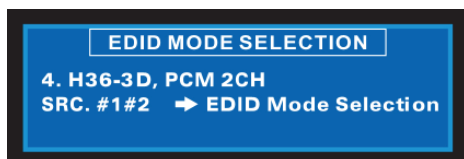

Audio Support: PCM 2CH

Mode 5. H36-3D (1080p-36 bits)

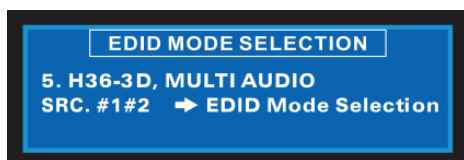

Audio Support: MAT(MLP) 7.1CH, PCM2CH, One Bit Audio 2CH, AC-3 5.1CH, DTS5.1CH, PCM7.1CH, Dolby Digital + 7.1CH, DTS-HD 7.1CH

Mode 6. 4K2K

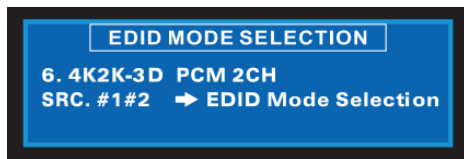

Video Support: 4K2K-3D 3860x2160

Audio Support: PCM 2CH

Mode 7. 1920x1200-60Hz (DVI-D)

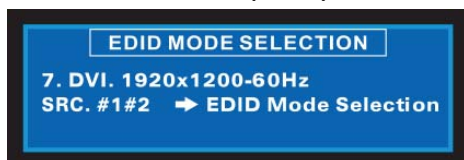

DVI Support: DVI-D 1920x1200 60Hz

EDID FUNCTION

EDID FUNCTION : LEARNING

Learning EDID

Single Destination to Single Source



Copy the EDID of a single destination device and pass it to a single source. The source device will output video and audio according to the EDID of the destination.

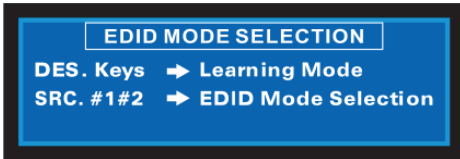

1. Enter EDID setup page.

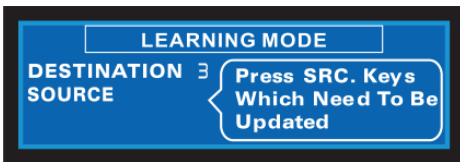

2. Choose one destination

Example: Select Destination 3

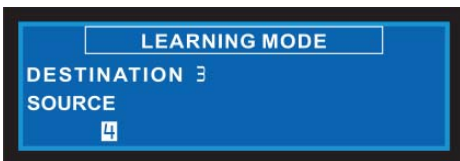

3. Then choose the intended source

Example: Select Source 4

Learning EDID

Single Destination to Multiple / All Sources



Copy the EDID of a single destination device and pass it to multiple sources. The source device will output video and audio according to the EDID of the destination.

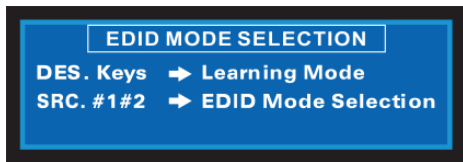

1. Enter EDID setup page.

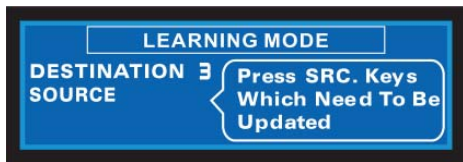

2. Choose one destination

Example: Select Destination 3

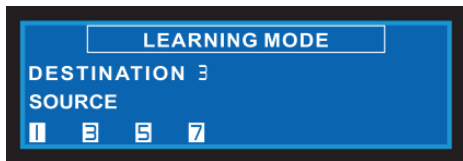

3. Then choose the intended source

Example: Select Source 1, 3, 5, 7.

Users who want all the 16 sources to learn the EDID from a destination, press all the 16 source buttons instead of the ALL button.

EDID FUNCTION

EDID FUNCTION FOR HDMI MATRIX SWITCHER

	Learning	Auto Mode
Definition	Let the source(s) learn the EDID from a single source and output video/audio accordingly.	Let all the sources output the highest common resolution of all the connected destination devices.
Operation	Select a destination first and then select the desired sources.	Use source button 1 or 2 to switch between EDID modes and select mode number 8.
Application	The switcher passes EDID from: 1 destination -> 1 source or 1 destination -> 1~16 sources	Once Auto Mode is set, all sources will be affected.
Memory	The switcher supports a total of 32 sets of learning routes. The 16 destination and source buttons are used as memory locations.	Cannot be memorized.
Note	When the source has "learned" the EDID information from a destination, the switcher will save that EDID data into EPROM and the stored EDID cannot be altered. If you want to remove the stored EDID, set a new learning route for the destination.	When auto mode is set, users may continue to select mode 1, FSS, for quicker startup of the switcher.

COMPARISON TABLE

	Function	Note
Learning Mode	Let the source device(s) learn the EDID from a single source and output video and audio accordingly.	When a source devices has "learned" the EDID information of a destination device, the switcher will save that EDID into EPROM and the stored EDID cannot be altered. If you want to remove the EDID, set a new learning route for the source.
FSS Mode (Mode 1)	Shorten the startup time of the switcher.	After the desired EDID setup is complete, use FSS mode and the switcher will be faster at startup.
Mode 2 ~ 7	Let all source devices output the specified video and audio formats.	Consult the spec documentation of your devices and select the mode that best suits them.

EDID FUNCTION

Q & A

Q. Must a destination device display video and sound based on its own EDID?

No. A destination device does not have to display its native resolution. Through the EDID learning function, a destination device can display based on the EDID of another destination, assuming there is no capability issue. Take the following 8x8 switcher for example. Suppose all the destination and source ports are connected.

How to let Destination 2 display the movie from Source 1, based upon the EDID of Destination 3?

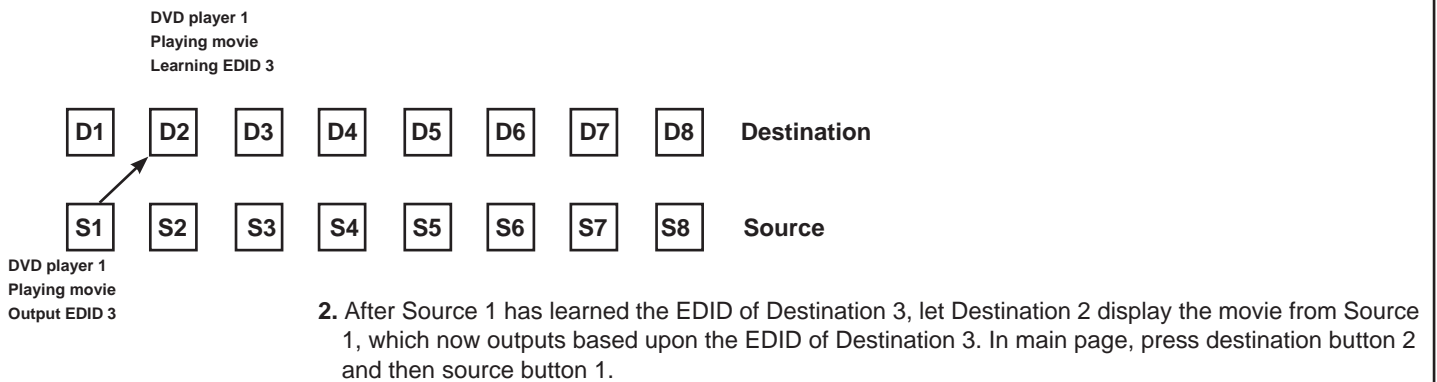
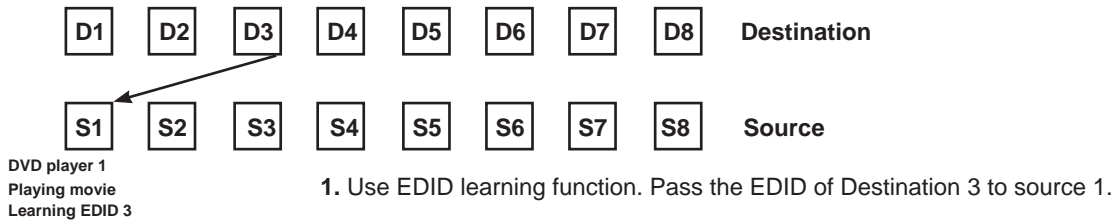

TYPICAL APPLICATION

INSTALLING DIAGRAM

Sample connection using IR transmitters (SB-101) and IR receiver (SB-100) with SB-6335T & SB-6335R to control a projector.

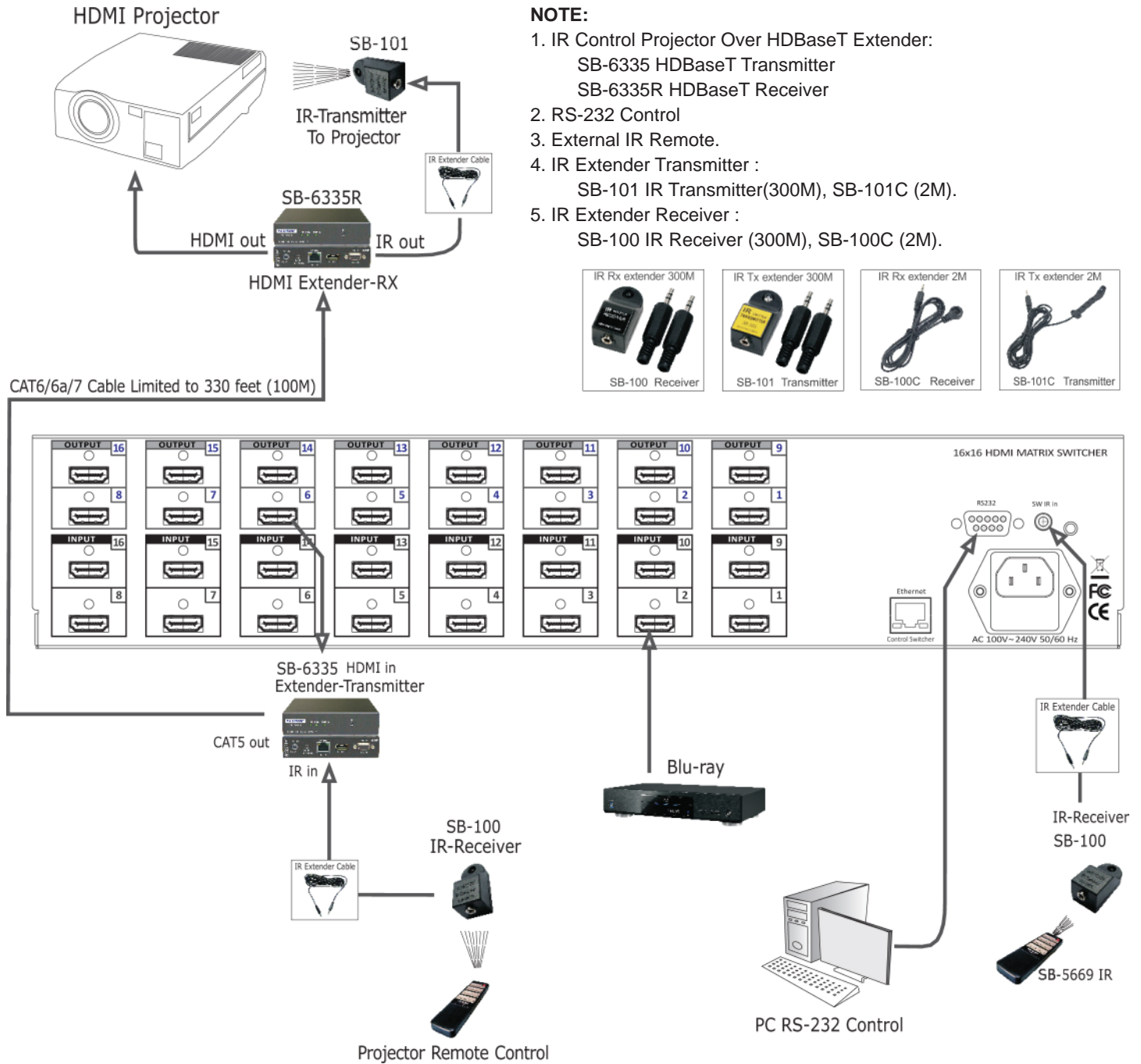

16 HDMI inputs To 16 HDMI outputs Matrix Switcher using IR transmitters (SB-101) and IR receiver (SB-100).

TYPICAL APPLICATION

INSTALLING DIAGRAM

Example connection using IR transmitters (SB-101) and IR receivers (SB-100) with SB-6335T and SB-6335R to control a satellite receiver.

NOTE:

1. IR Control Satellite Receiver Over HDBaseT CAT6/6a/7 extender from room:

SB-6335 HDBaseT CAT5e/6/7 Transmitter

SB-6335R HDBaseT CAT5e/6/7 Receiver

2. Audio Extractor To Recode Audio :

SB-5609 HDMI Audio Extractor.

3. Control HDMI ARC: SB-5610 ARC Control Box.

4. IR Extender Transmitter :

SB-101 (300M) Transmitter, SB-101(2M).

5. IR Extender Receiver :

SB-100 (300M) Receiver, SB-100(2M).

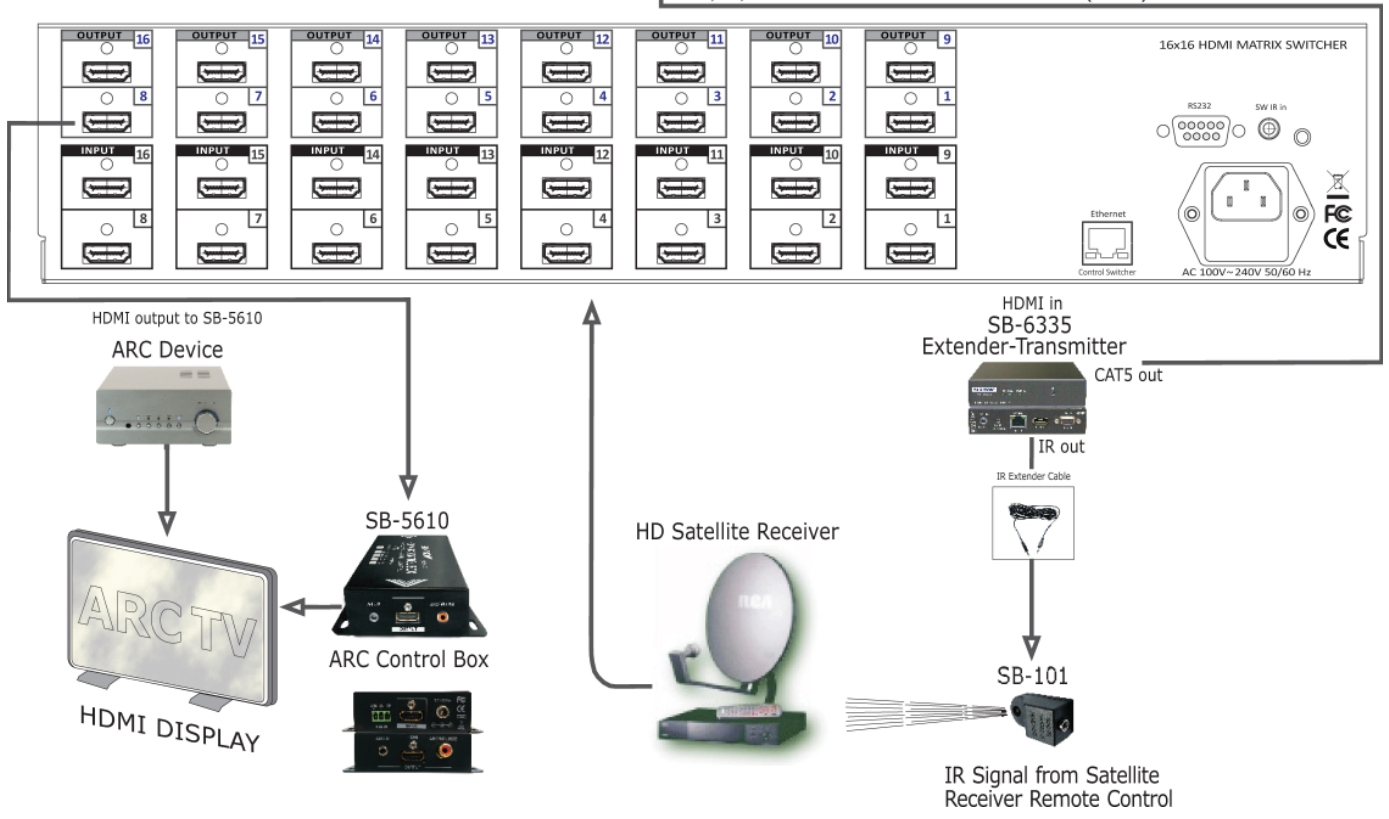
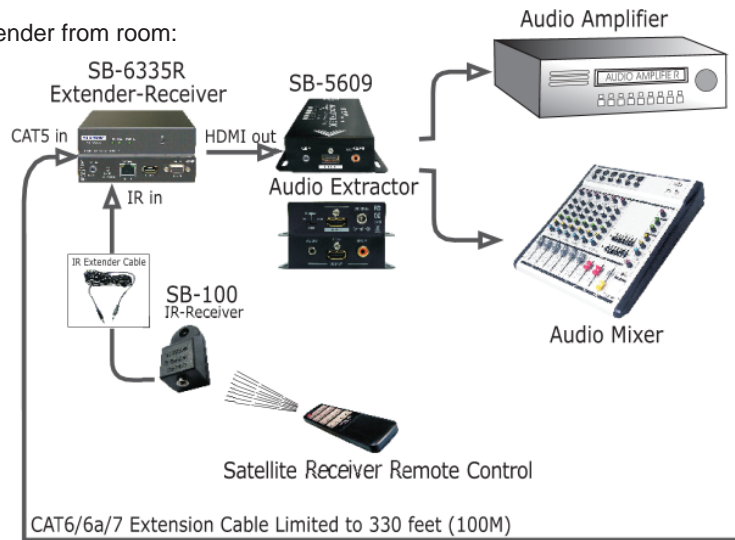

16 HDMI inputs To 16 HDMI outputs Matrix Switcher using IR transmitters (SB-101) and IR receiver (SB-100).

IR EXTENDER

REAR PANEL IR EXTENDER PORT

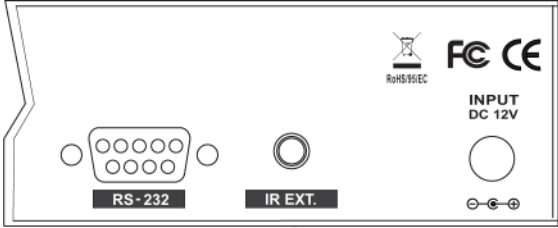

IR EXTENDER CONNECTION

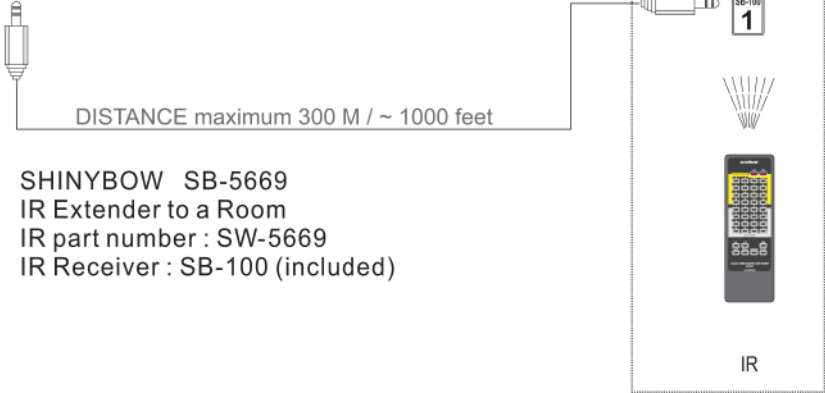

SHINYBOW SB-5669
 IR Extender to a Room
 IR part number : SW-5669
 IR Receiver : SB-100 (included)

*** When you plug the External IR extender into the switcher, the front panel IR receiver remains active. ***

IR EXTENDER PACKAGE :

HOW TO SETUP THE IR EXTENDER COMPONENTS

IR Extender 300M Receiver

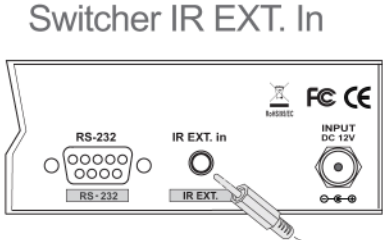

Cable(3C)
 Distance:Max.300M



Pin configuration for IR Receiver such as **SB-100** or compatible

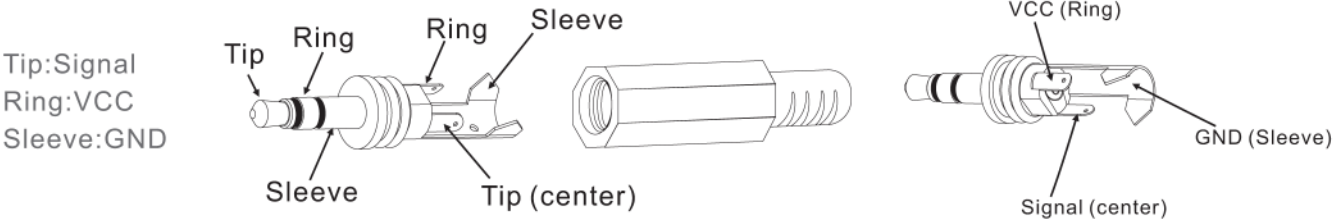

ETHERNET SERIAL INTERFACE

ETHERNET SERIAL INTERFACE CONNECT A PC OR CONTROL SYSTEM. VERSION COMPATIBLE V2.0

For a complete list of commands, please reference external document extended Ethernet Protocol Instruction Manual.

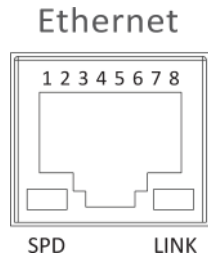

Note :

Control the switcher

SPD : Speed

LINK : Ethernet link

RJ-45 Female 8P-8 Connector

ETHERNET SERIAL INTERFACE

Pin	Ethernet	Reference
1	TXOP	TX +
2	TXON	TX -
3	RXIP	RX +
4	NC	
5	NC	
6	RXIN	RX -
7	NC	
8	GND	

ETHERNET TCP/IP PROTOCOL COMMANDS (Ethernet / RS-232 Control driver V2.0.1)

The ShinybowUSA switcher can be controlled via the TCP/IP serial control port to allow for interfacing to a PC, or similar third party control system.

The serial communication parameters are 9600 baud, 8 bit, No Parity and 1 stop bit - this is often referred to as 9600 8N1.

When the unit recognizes a complete command it will perform the requested action - there is no delimiter character required.

RS-232 SERIAL INTERFACE

RS-232 SERIAL INTERFACE CONNECT A PC OR CONTROL SYSTEM. VERSION -2.0 COMPATIBLE

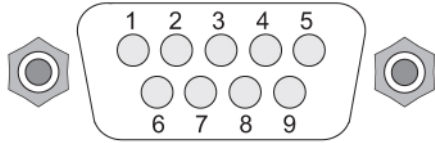

RS-232 SERIAL INTERFACE

Pin	RS-232	Definition
1	-----	Not used
2	TX	Transmitter
3	RX	Receiver
4	-----	Not used
5	GND	Ground
6	-----	Not used
7	-----	Not used
8	-----	Not used
9	-----	Not used

RS-232 PROTOCOL COMMANDS (RS-232 Control driver V2.0.1)

The ShinybowUSA switcher can be controlled via the RS-232 serial control port to allow for interfacing to a PC, or similar third party control system.

The serial communication parameters are 9600 baud, 8 bit, No Parity and 1 stop bit - this is often referred to as 9600 8N1. When the unit recognizes a complete command it will perform the requested action - there is no delimiter character required.

LIMITED WARRANTY

PLEASE READ THE FOLLOWING TERMS AND CONDITIONS CAREFULLY BEFORE USING THIS HARDWARE, COMPONENTS AND SOFTWARE PROVIDED BY, THROUGH OR UNDER SHINYBOWUSA, INC (COLLECTIVELY, THE "PRODUCT"). By using installing or using the Product, you unconditionally signify your agreement to these Terms and Conditions. If you do not agree to these Terms and Conditions, do not use the Product and return the Product to SHINYBOWUSA, Inc. at the return address set forth on the Product's packing label at your expense. SHINYBOWUSA, Inc. may modify these Terms and Conditions at anytime, without notice to you.

RESTRICTIONS ON USE OF THE PRODUCT

It is your responsibility to read and understand the installation and operation instructions, both verbal and in writing, provided to you with respect to the Product. You are authorized to use the Product solely in connection with such instructions. Any use of the Product not in accordance with such instructions shall void any warranty pertaining to the Product. Any and all damages that may occur in the use of the Product that is not strictly in accordance with such instructions shall be borne by you and you agree to indemnify and hold harmless SHINYBOWUSA, Inc. from and against any such damage.

The Product is protected by certain intellectual property rights owned by or licensed to SHINYBOWUSA. Any intellectual property rights pertaining to the Product are licensed to you by SHINYBOWUSA, Inc. and/or its affiliates, including any manufacturers or distributors of the Product (collectively, "SHINYBOWUSA") for your personal use only, provided that you do not change or delete any proprietary notices that may be provided with respect to the Product.

The Product is sold to you and any use of any associated intellectual property is deemed to be licensed to you by SHINYBOWUSA for your personal use only. SHINYBOWUSA does not transfer either the title or the intellectual property rights to the Product and SHINYBOWUSA retains full and complete title to the intellectual property rights therein. All trademarks and logos are owned by SHINYBOWUSA or its licensors and providers of the Product, and you may not copy or use them in any manner without the prior written consent of SHINYBOWUSA, which consent may be withheld at the sole discretion of SHINYBOWUSA.

The functionality and usability of the Product is controlled by SHINYBOWUSA, Inc. from its offices within the State of Texas, United States of America. SHINYBOWUSA makes no representation that materials pertaining to the Product are appropriate or available for use in other locations other than the shipping address you provided with respect thereto. You are advised that the Product may be subject to U.S. export controls.

Disclaimers and Limitation of Liability

SHINYBOWUSA may change or modify the Product at any time, from time to time.

THE PRODUCT IS PROVIDED "AS IS" AND WITHOUT WARRANTIES OF ANY KIND EITHER EXPRESS OR IMPLIED. SHINYBOWUSA DOES NOT WARRANT OR MAKE ANY REPRESENTATIONS REGARDING THE USE OR THE RESULTS OF THE USE OF THE PRODUCT'S CORRECTNESS, ACCURACY, RELIABILITY, OR OTHERWISE.

SHINYBOWUSA has no duty or policy to update any information or statements pertaining to the Product and, therefore, such information or statements should not be relied upon as being current as of the date you use the Product. Moreover, any portion of the materials pertaining to the Product may include technical inaccuracies or typographical errors. Changes may be made from time to time without notice with respect to the Product.

TO THE FULLEST EXTENT PERMISSIBLE PURSUANT TO APPLICABLE LAW, SHINYBOWUSA DISCLAIMS ALL WARRANTIES, EXPRESS OR IMPLIED, INCLUDING, BUT NOT LIMITED TO IMPLIED WARRANTIES OF MERCHANTABILITY, FITNESS FOR A PARTICULAR PURPOSE AND NON-INFRINGEMENT. SHINYBOWUSA DOES NOT WARRANT THE ACCURACY, COMPLETENESS OR USEFULNESS OF ANY INFORMATION WITH RESPECT TO THE PRODUCT. SHINYBOWUSA DOES NOT WARRANT THAT THE FUNCTIONS PERTAINING TO THE PRODUCT WILL BE ERROR-FREE, THAT DEFECTS WITH RESPECT TO THE PRODUCT WILL BE CORRECTED, OR THAT THE MATERIALS PERTAINING THERETO ARE FREE OF DEFECTS OR OTHER HARMFUL COMPONENTS. SHINYBOWUSA WILL USE ITS REASONABLE EFFORTS TO CORRECT ANY DEFECTS IN THE PRODUCT UPON TIMELY WRITTEN NOTICE FROM YOU NOT TO EXCEED 10 BUSINESS DAYS AFTER RECEIPT BY YOU OF THE PRODUCT, BUT YOU (AND NOT SHINYBOWUSA) ASSUME THE ENTIRE COST OF ALL NECESSARY SERVICING, REPAIR AND CORRECTION THAT WAS CAUSED BY YOU UNLESS OTHERWISE AGREED TO IN A SEPARATE WRITING BY SHINYBOWUSA.

UNDER NO CIRCUMSTANCES, INCLUDING, BUT NOT LIMITED TO, NEGLIGENCE, SHALL SHINYBOWUSA BE LIABLE FOR ANY SPECIAL OR CONSEQUENTIAL DAMAGES THAT RESULT FROM THE USE OF, OR THE INABILITY TO USE THE PRODUCT IN ACCORDANCE WITH ITS SPECIFICATIONS, EVEN IF SHINYBOWUSA OR ITS REPRESENTATIVES HAVE BEEN ADVISED OF THE POSSIBILITY OF SUCH DAMAGES. IN NO EVENT SHALL SHINYBOWUSA'S TOTAL LIABILITY TO YOU FROM ALL DAMAGES, LOSSES, AND CAUSES OF ACTION (WHETHER IN CONTRACT, OR OTHERWISE) EXCEED THE AMOUNT YOU PAID TO SHINYBOWUSA, IF ANY, FOR THE PRODUCT.

END OF DOCUMENT

SHINYBOW™ USA

MULTIMEDIA AUDIO AND VISUAL
