

# datavideo

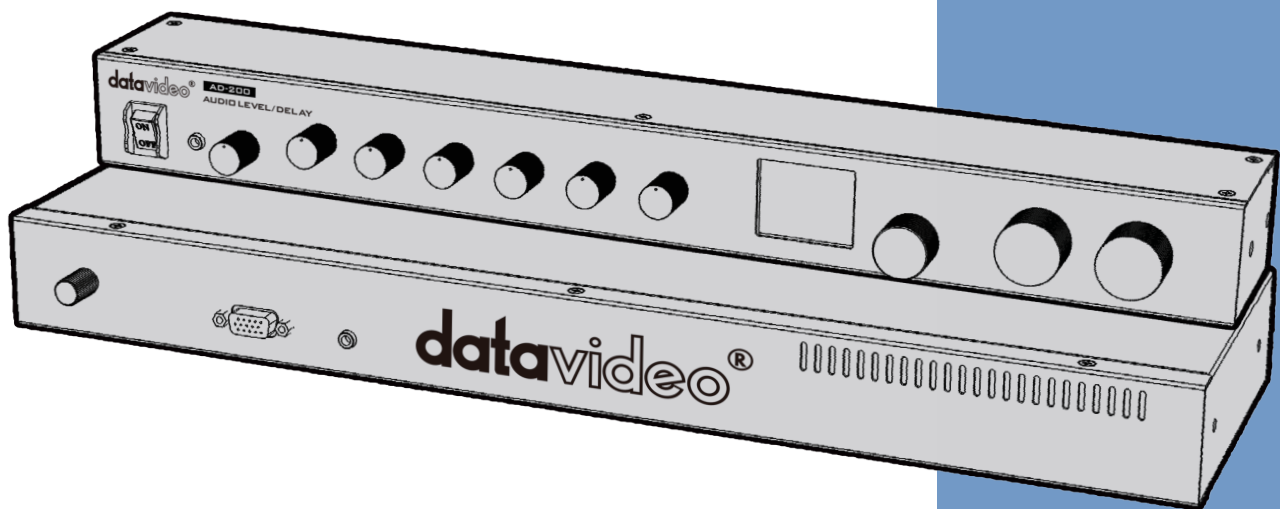

AUDIO DELAY BOX WITH  
LEVEL ADJUSTMENT

**AD-200**

**Instruction manual**

[www.datavideo.com](http://www.datavideo.com)

# Table of Contents

<b>FCC COMPLIANCE STATEMENT</b> .....	<b>3</b>
<b>WARNINGS AND PRECAUTIONS</b> .....	<b>3</b>
<b>WARRANTY</b> .....	<b>4</b>
STANDARD WARRANTY.....	4
THREE YEAR WARRANTY .....	4
<b>DISPOSAL</b> .....	<b>4</b>
<b>D-SUB CABLE</b> .....	<b>5</b>
<b>CONNECTED CABLE</b> .....	<b>5</b>
MAIN UNIT (FRONT PANEL) .....	6
MAIN UNIT (REAR PANEL).....	7
CONTROL UNIT (FRONT PANEL) .....	8
CONTROL UNIT (REAR PANEL) .....	9
AUX AUDIO INPUTS AND LEVELS .....	10
ON-SCREEN DISPLAY FUNCTION MENU.....	10
<b>SPECIFICATIONS</b> .....	<b>12</b>

## Disclaimer of Product & Services

The information offered in this instruction manual is intended as a guide only. At all times, Datavideo Technologies will try to give correct, complete and suitable information. However, Datavideo Technologies cannot exclude that some information in this manual, from time to time, may not be correct or may be incomplete. This manual may contain typing errors, omissions or incorrect information. Datavideo Technologies always recommend that you double check the information in this document for accuracy before making any purchase decision or using the product. Datavideo Technologies is not responsible for any omissions or errors, or for any subsequent loss or damage caused by using the information contained within this manual. Further advice on the content of this manual or on the product can be obtained by contacting your local Datavideo Office or dealer.

# FCC Compliance Statement

This device complies with part 15 of the FCC rules. Operation is subject to the following two conditions:

- (1). This device may not cause harmful interference, and
- (2). This device must accept any interference received, including interference that may cause undesired operation.

## Warnings and Precautions

1. Read all of these warnings and save them for later reference.
2. Follow all warnings and instructions marked on this unit.
3. Unplug this unit from the wall outlet before cleaning. Do not use liquid or aerosol cleaners. Use a damp cloth for cleaning.
4. Do not use this unit in or near water.
5. Do not place this unit on an unstable cart, stand, or table. The unit may fall, causing serious damage.
6. Slots and openings on the cabinet top, back, and bottom are provided for ventilation. To ensure safe and reliable operation of this unit, and to protect it from overheating, do not block or cover these openings. Do not place this unit on a bed, sofa, rug, or similar surface, as the ventilation openings on the bottom of the cabinet will be blocked. This unit should never be placed near or over a heat register or radiator. This unit should not be placed in a built-in installation unless proper ventilation is provided.
7. This product should only be operated from the type of power source indicated on the marking label of the AC adapter. If you are not sure of the type of power available, consult your Datavideo dealer or your local power company.
8. Do not allow anything to rest on the power cord. Do not locate this unit where the power cord will be walked on, rolled over, or otherwise stressed.
9. If an extension cord must be used with this unit, make sure that the total of the ampere ratings on the products plugged into the extension cord do not exceed the extension cord rating.
10. Make sure that the total amperes of all the units that are plugged into a single wall outlet do not exceed 15 amperes.
11. Never push objects of any kind into this unit through the cabinet ventilation slots, as they may touch dangerous voltage points or short out parts that could result in risk of fire or electric shock. Never spill liquid of any kind onto or into this unit.
12. Except as specifically explained elsewhere in this manual, do not attempt to service this product yourself. Opening or removing covers that are marked "Do Not Remove" may expose you to dangerous voltage points or other risks, and will void your warranty. Refer all service issues to qualified service personnel.
13. Unplug this product from the wall outlet and refer to qualified service personnel under the following conditions:
  - a. When the power cord is damaged or frayed;
  - b. When liquid has spilled into the unit;
  - c. When the product has been exposed to rain or water;
  - d. When the product does not operate normally under normal operating conditions. Adjust only those controls that are covered by the operating instructions in this manual; improper adjustment of other controls may result in damage to the unit and may often require extensive work by a qualified technician to restore the unit to normal operation;
  - e. When the product has been dropped or the cabinet has been damaged;
  - f. When the product exhibits a distinct change in performance, indicating a need for service.



# Warranty

## Standard Warranty

- Datavideo equipment are guaranteed against any manufacturing defects for one year from the date of purchase.
- The original purchase invoice or other documentary evidence should be supplied at the time of any request for repair under warranty.
- The product warranty period begins on the purchase date. If the purchase date is unknown, the product warranty period begins on the thirtieth day after shipment from a Datavideo office.
- Damage caused by accident, misuse, unauthorized repairs, sand, grit or water is not covered under warranty.
- Viruses and malware infections on the computer systems are not covered under warranty.
- Any errors that are caused by unauthorized third-party software installations, which are not required by our computer systems, are not covered under warranty.
- All mail or transportation costs including insurance are at the expense of the owner.
- All other claims of any nature are not covered.
- Cables and batteries are not covered under warranty.
- Warranty only valid in the country or region of purchase.
- Your statutory rights are not affected.

## Three Year Warranty

- All Datavideo products purchased after July 1st, 2017 are qualified for a free two years extension to the standard warranty, providing the product is registered with Datavideo within 30 days of purchase.
- Certain parts with limited lifetime expectancy such as LCD panels, DVD drives, Hard Drive, Solid State Drive, SD Card, USB Thumb Drive, Lighting, Camera module, PCIe Card are covered for 1 year.
- The three-year warranty must be registered on Datavideo's official website or with your local Datavideo office or one of its authorized distributors within 30 days of purchase.



## Disposal

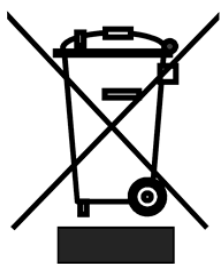

### For EU Customers only - WEEE Marking

This symbol on the product or on its packaging indicates that this product must not be disposed of with your other household waste. Instead, it is your responsibility to dispose of your waste equipment by handing it over to a designated collection point for the recycling of waste electrical and electronic equipment. The separate collection and recycling of your waste equipment at the time of disposal will help to conserve natural resources and ensure that it is recycled in a manner that protects human health and the environment. For more information about where you can drop off your waste equipment for recycling, please contact your local city office, your household waste disposal service or the shop where you purchased the product.



**CE Marking** is the symbol as shown on the left of this page. The letters "CE" are the abbreviation of French phrase "Conformité Européene" which literally means "European Conformity". The term initially used was "EC Mark" and it was officially replaced by "CE Marking" in the Directive 93/68/EEC in 1993. "CE Marking" is now used in all EU official documents.

# Connection of AD-200 main unit and AD-200 control unit

## AD-200 Main Unit

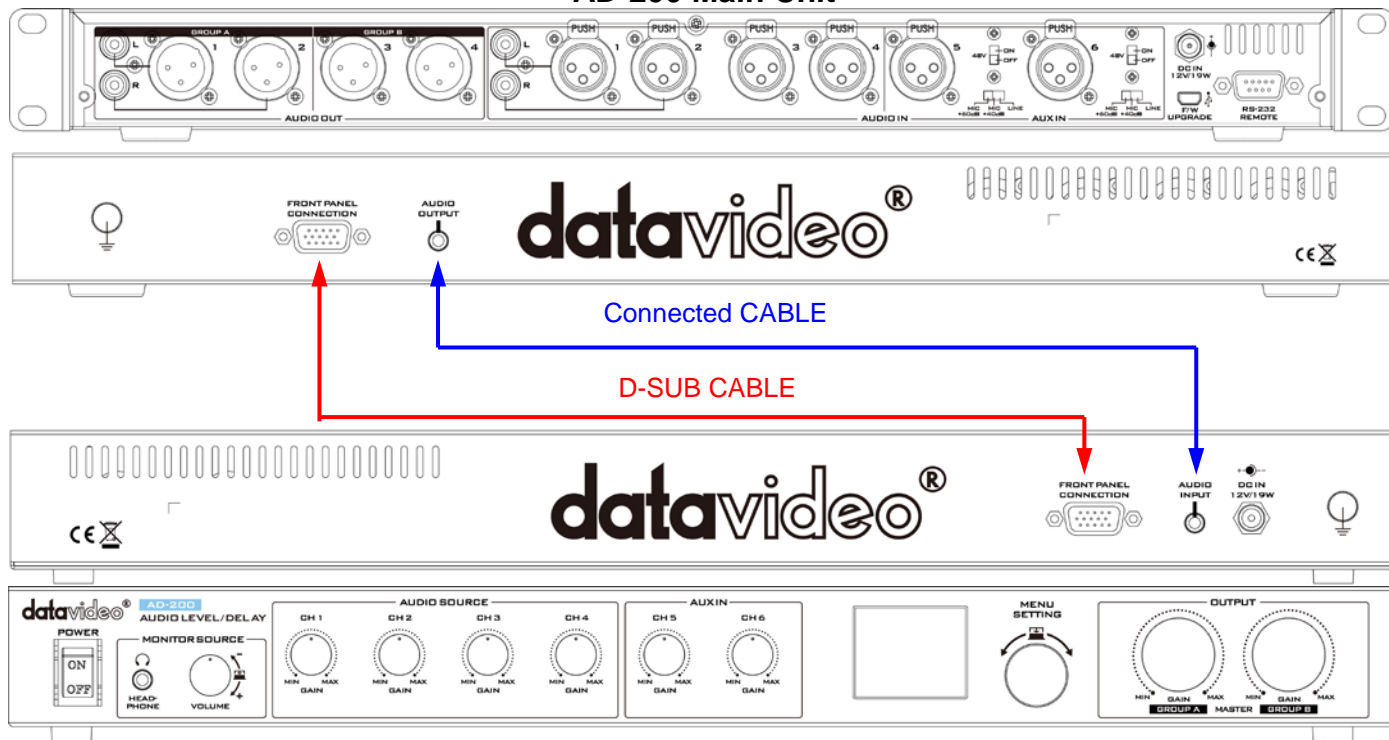

## AD-200 Control Unit

D-Sub Cable



Connected Cable



Connections & Controls  
**Main Unit (Front Panel)**

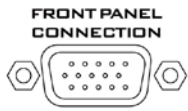

**Connection**

Use D-SUB Cable to connect AD-200 main unit to AD-200 control unit.

**AUDIO  
OUTPUT**



**Audio Output**

Audio input of control unit must be connected to audio output of main unit via a connected cable.



**Grounding Terminal**

When connecting this unit to any other component, make sure that it is properly grounded by connecting this terminal to an appropriate point. When connecting, use the socket and be sure to use wire with a cross-sectional area of at least 1.0 mm<sup>2</sup>.

# Main Unit (Rear Panel)

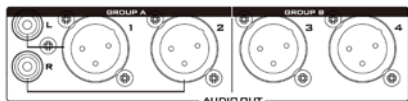
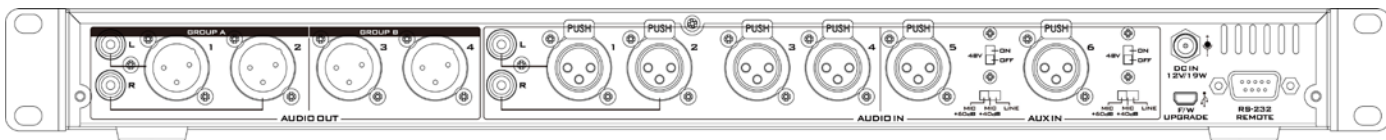

## Audio Output

RCA audio output & 4 XLR balanced audio output channels (You can use ch1, 2 audio out for XLR or RCA).

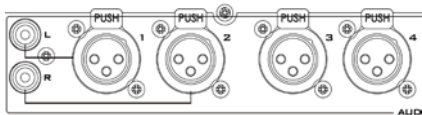

## Audio input

RCA audio input & 4 XLR balanced audio input channels (You can use ch1, 2 audio input for XLR or RCA)

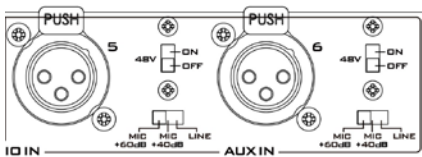

## AUX Audio Input

2 channels of XLR balanced audio input.  
For more information please see **page 8** for more details.

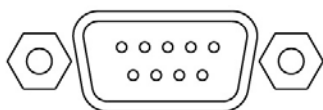

**RS-232 REMOTE**

## RS-232 REMOTE

To be updated.



**F/W UPGRADE**

## USB

Firmware Upgrades



**DC IN 12V/19W**

## DC IN Socket

Connect the supplied 12V PSU to this socket. The power connection can be secured by screwing the outer fastening ring of the DC IN plug to the socket.

# Control Unit (Front Panel)

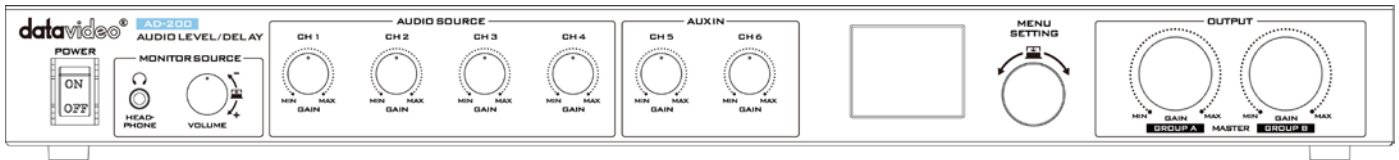

## POWER



### Power Switch

Switches the power On / Off.

## MONITOR SOURCE

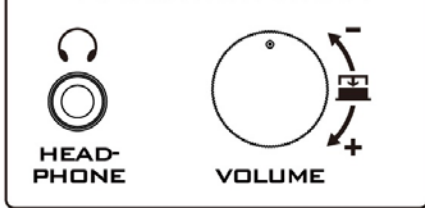

### Headphone

Accepts a stereo mini jack plug for stereo headphones. The headphone volume is adjusted by rotating head phone volume control.

### Headphone Volume Control

Controls Headphone volume level.

Use the Headphone section to accurately monitor any of the sources output.

Push this button to switch audio source 1~6 and audio output 1, 2.



### Audio Input Source Level Controls

The AD-200 controls audio input channel (CH1~CH6).

This row of audio channel selection buttons has built-in OLED to show active input channel. Level control for each audio input source is done by rotating the knobs above each of the audio channel selection buttons.

(Level ranges from -80dB to +12dB)

The maximum audio level gain can be configured using the SET GAIN function on OSD menu.

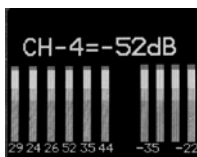

### OLED Panel

Audio Meters & Function Display.

## MENU SETTING

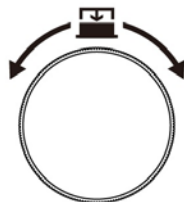

### MENU Navigation Button

Rotate to change options and press in to select.

For more information please see the **Menu Function**.

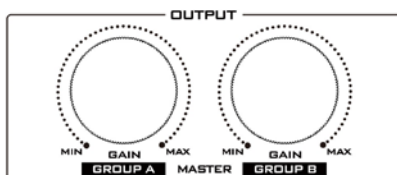

### Audio Output Source Level Controls

GROUP A = Control the CH1,2 output volume.

GROUP B = Control the CH3,4 output volume.



## Control Unit (Rear Panel)



### Connection

Use D-SUB Cable to connect AD-200 main unit to AD-200 control unit.

### AUDIO INPUT



### Audio Input

Audio input of control unit must be connected to audio output of main unit via a connected cable.



### DC IN Socket

Connect the supplied 12V PSU to this socket. The power connection can be secured by screwing the outer fastening ring of the DC In plug to the socket.

*Note: AD-200 main unit and AD-200 control unit both have **DC IN Socket**, they are the same function, you just need select one socket to supply the power input.*

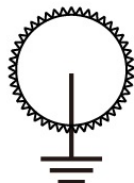

### Grounding Terminal

When connecting this unit to any other component, make sure that it is properly grounded by connecting this terminal to an appropriate point. When connecting, use the socket and be sure to use wire with a cross-sectional area of at least 1.0 mm<sup>2</sup>.

## AUX Audio Inputs and Levels

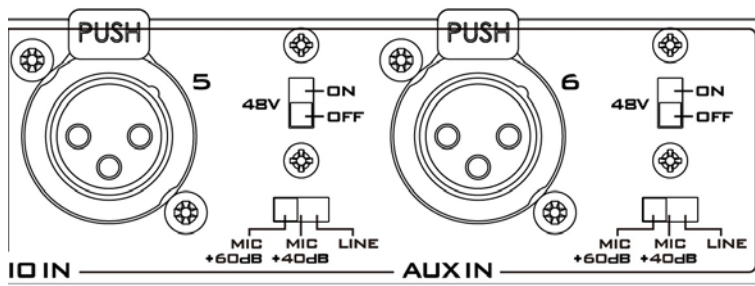

There are two types of switches for configuring **AUDIO IN**:

The **LINE/MIC+40dB/MIC+60dB** switch is used to set the **AUDIO IN** to **LINE IN**, **MIC+40dB IN** or **MIC+60dB IN**. When **LINE IN** is selected, set the **48V** switch to **OFF** in order to prevent damage to the circuit due to excessive current flow.

The **48V** switch is designed specifically for phantom power control. To use **MIC IN**, set the **LINE/MIC+40dB/MIC+60dB** switch to **MIC IN**. Turn the **48V** switch to **ON** if a **condenser microphone** is used. Turn the **48V** switch to **OFF** if a **dynamic microphone** is used.

**\*NOTE:** Always check the manual for the appropriate microphone and read the advice in the manual regarding phantom power as some MICs have internal batteries too.

## On-Screen Display Function Menu

### 1. MIXER I/O Configuration

The mixer has six input channels, which are mixed in different combinations. The mixed audio is subsequently sent to the output channel. In the example illustrated below, the mixer setting is configured by enabling the desired audio input channels and feeding the enabled combination to the corresponding output channel.

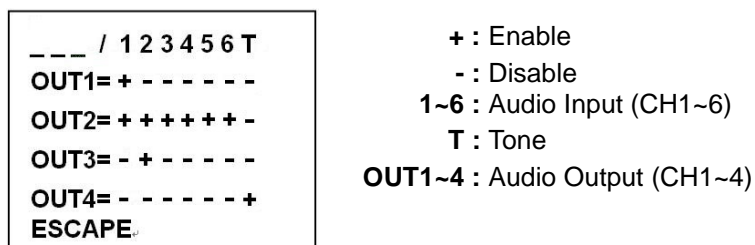

Description of the above configuration example:

Out1 is audio input CH1 only.

Out2 is audio input CH1~6 mixed.

Out3 is audio input CH2 only.

Out4 is tone mixed.

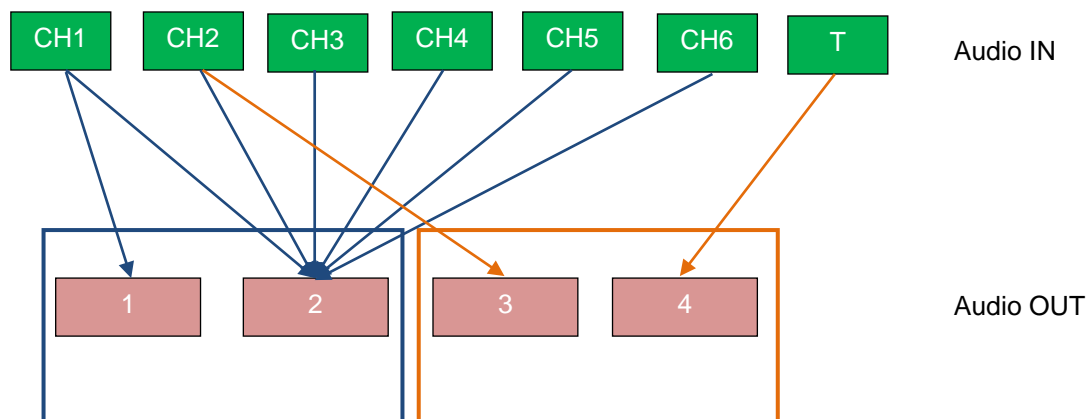

## 2. DELAY TIME

This function sets audio input delay time ranging from 0000~3000 mSEC.

## 3. TONE MODE

**FQ.:** This function sets TONE frequency of 1KHz, 6KHz or 12 KHz

**LEL:** This function sets TONE level ranging from -48~+24 dBu.

## 4. DISPLAY

**BRI.:** This function sets OLED panel brightness. There are five brightness levels with five filled square boxes being the brightest and one filled square box being the least bright.

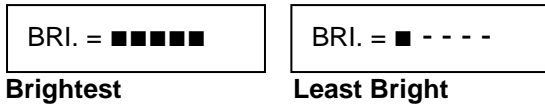

**TEST:** Different colours (Red, Green, Blue, Black and White) are available for testing OLED panel.

**DIM:** The OLED panel dims after the device is idle for 10 seconds. There are four dim levels with four filled square boxes being no dim and one filled square box being the most dim.

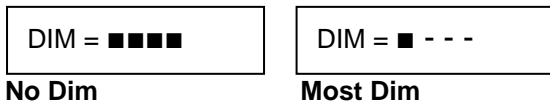

**RESET:** This function resets all settings to factory default.

## 5. SET GAIN

This function sets the maximum audio level gain (0, 6 or 12 dB) for CH1-6, OUTA/B and MNTR knobs.

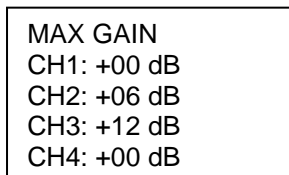

## System Diagram

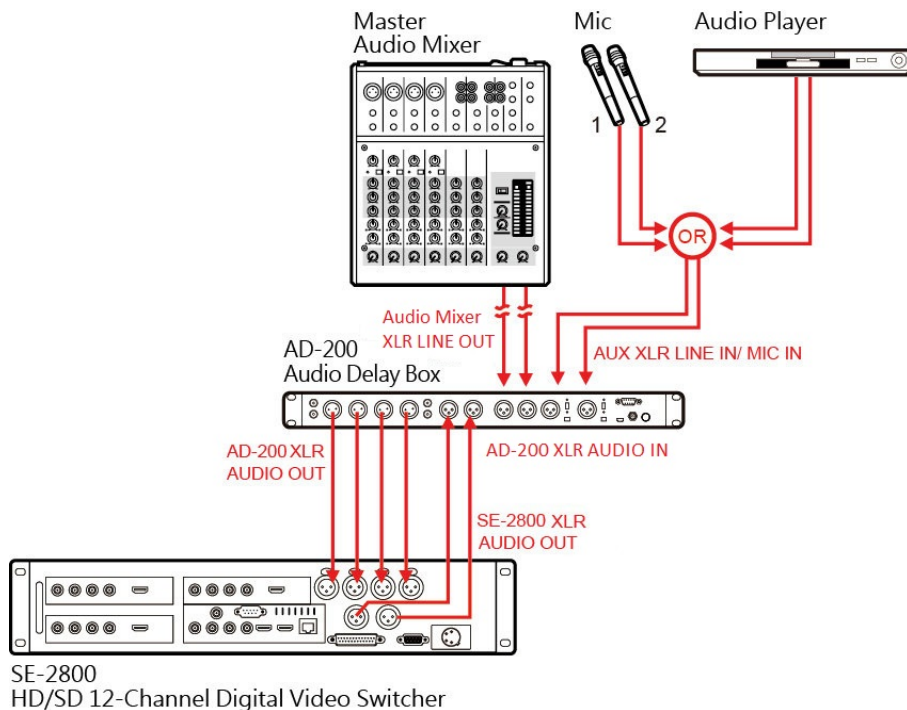

## Specifications

AUX IN				
Parameter	Specification	Limit	Units	Conditions/Comments
MIC/Line Connectors (CH5~CH6)	3Pin XLR Female	NA	NA	Pin2=(+),Pin3=(-),Pin1=GND
Mic/Line Input Impedance(CH5/CH6)	2K/3K	10%	$\Omega$	NA
Mic Gain Range	+40dB /+60dB	$\pm 3$	dB	Slide switch
Line Gain Range	off to +12	$\pm 3$	dB	Audio source GAIN(knob)
THD+N	0.01	max	%	@ 1KHz,0dB(Lin IN)
Line in Max Level	+23dBu	$\pm 3\%$	dBu	NA
Signal to noise ratio	80	min	dB	@ 1KHz,6dBu(Lin IN)
Frequency Response	20Hz~20KHz	$\pm 3$	dB	NA

AUDIO IN				
Parameter	Specification	Limit	Units	Conditions/Comments
Input (CH1~CH4) Connectors	3Pin XLR Female	NA	NA	Pin2=(+),Pin3=(-),Pin1=GND
Input Impedance	25K	10%	$\Omega$	NA
Gain Range	off to +12	$\pm 3$	dB	Audio source GAIN(knob)
Signal to noise ratio	80	min	dB	@ 1KHz,6dBu
THD+N	0.01	max	%	@ 1KHz,0dB
Frequency Response	20Hz~20KHz	$\pm 3$	dB	NA
unbalanced mono audio (L, R)	RCA	NA	NA	NA
Signal to noise ratio	80	min	dB	@ 1KHz,0dB(RCA IN)
THD+N	0.01	max	%	@ 1KHz,0dB(RCA IN)
Impedance	15K	10%	$\Omega$	NA

Audio Output				
Parameter	Specification	Limit	Units	Conditions/Comments
Connector (1,2,3,4)(Group A,B)	3Pin XLR Male	NA	NA	Pin2=(+),Pin3=(-),Pin1=GND
Impedance	65	5%	$\Omega$	NA
Gain Range	off to +12	$\pm 3$	dB	OUTPUT (Group A.B)(knob)
Output Max Level	+23dBu	$\pm 1.5\%$	dBu	NA
unbalanced mono audio (L, R)	RCA	NA	NA	NA
Gain Range	off to +12	$\pm 3$	dB	OUTPUT (Group A.B)(knob)
Impedance	330	5%	$\Omega$	NA

Headphone				
Parameter	Specification	Limit	Units	Conditions/Comments
Connector	3.5mm phone jack	NA	NA	Tip(+),Ring=(-),Sleeve=GND
Signal to noise ratio	75	min	dB	@ 1KHz,0dB(Lin IN)
THD+N	0.01	max	%	@ 1KHz,0dB(Lin IN)
Frequency Response	20Hz~20KHz	$\pm 3$	dB	NA

Others				
Parameter	Specification	Limit	Units	Conditions/Comments
Phantom Power	+48V	±3%	VDC	NA
Power Consumption	12V/19W	±3%	watts	NA
Power Input connector	2pin DC Jack	NA	NA	NA
Dimensions (Main Unit)	147 x 440 x 45.4	±1%	mm	L X W X H
Dimensions (Control Unit)	90.5 x 440 x 47.5	±1%	mm	L X W X H
Weight	Main Unit 1.8kg / Control Unit 1.1kg	NA	kg	NA
Display	1,77" OLED	NA	NA	160XRGBX128
Audio Delay for audio input	0~3 sec	NA	NA	NA

Operating and Storage temperature	
Parameter	Specification
Operating temperature	0 °C ~ +50 °C
Storage temperature	0 °C ~ +60 °C

Certification	CE / FCC
---------------	----------

**AD-200 Main Unit**

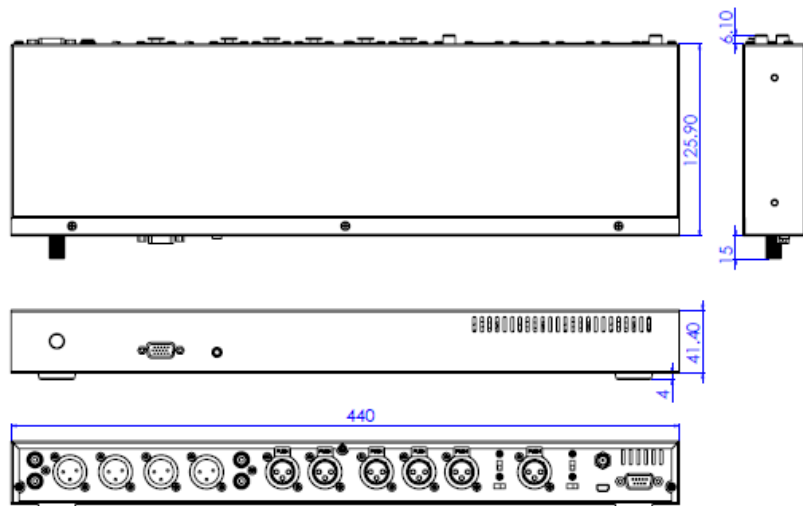

**AD-200 Control Unit**

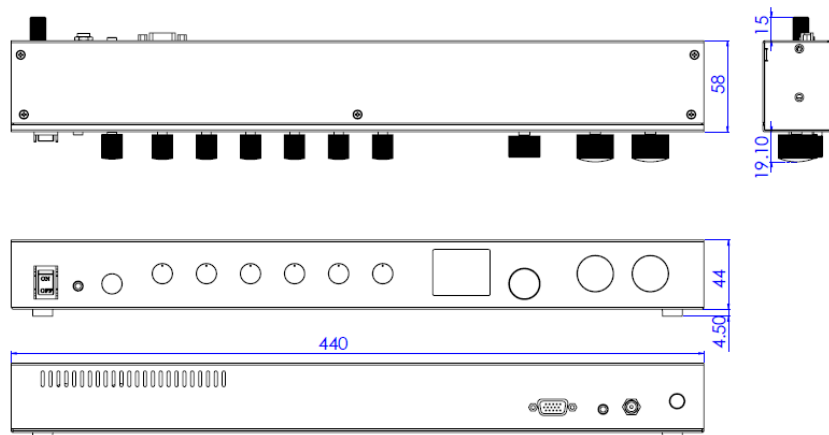

# Service & Support

It is our goal to make owning and using Datavideo products a satisfying experience. Our support staff is available to assist you to set up and operate your system. Contact your local office for specific support requests. Plus, please visit [www.datavideo.com](http://www.datavideo.com) to access our FAQ section.

**China Shanghai**  
Datavideo Technologies China Co  
601, Building 10, No. 1228,  
Rd. Jiangchang,  
Jingan District, Shanghai  
Tel: +86 21-5603 6599  
Fax: +86 21-5603 6770  
E-mail: [service@datavideo.cn](mailto:service@datavideo.cn)

**China Beijing**  
Datavideo Technologies China Co  
No. 812, Building B, Wankai Center,  
No. 316, Wan Feng Road, Fengtai District,  
Beijing, China  
Tel: +86 10-8586 9034  
Fax: +86 10-8586 9074  
E-mail: [service@datavideo.cn](mailto:service@datavideo.cn)

**China Chengdu**  
Datavideo Technologies China Co  
B-823, Meinian square, No. 1388,  
Middle of Tianfu Avenue, Gaoxin District,  
Chengdu, Sichuan  
Tel: +86 28-8613 7786  
Fax: +86 28-8513 6486  
E-mail: [service@datavideo.cn](mailto:service@datavideo.cn)

**China Fuzhou**  
Datavideo Technologies China Co  
A1-2318-19 Room, No. 8, Aojiang Road,  
Taijiang District, Fuzhou, Fujian, China  
Tel: 0591-83211756 · 0591-83210187  
Fax: 0591-83211262  
E-mail: [service@datavideo.cn](mailto:service@datavideo.cn)

**China Jinan**  
Datavideo Technologies China Co  
902, No. 1 business building,  
Xiangtai Square, No. 129,  
Yingxiongshan Road, Shizhong District,  
Jinan City, Shandong Province, China  
Tel: +86 531-8607 8813  
E-mail: [service@datavideo.cn](mailto:service@datavideo.cn)

**Hong Kong**  
Datavideo Hong Kong Ltd  
G/F., 26 Cross Lane  
Wanchai, Hong Kong  
Tel: +852-2833-1981  
Fax: +852-2833-9916  
E-mail: [info@datavideo.com.hk](mailto:info@datavideo.com.hk)

**India Noida**  
Datavideo India Noida  
A-132, Sec-63, Noida-201307,  
India  
Tel: +91-0120-2427337  
Fax: +91-0120-2427338  
E-mail: [sales@datavideo.in](mailto:sales@datavideo.in)

**India Kochi**  
Datavideo India Kochi  
2nd Floor- North Wing, Govardhan Building,  
Opp. NCC Group Headquarters, Chittoor Road,  
Cochin- 682035  
Tel: +91 4844-025336  
Fax: +91 4844-047696  
E-mail: [sales@datavideo.in](mailto:sales@datavideo.in)

**Netherlands**  
Datavideo Technologies Europe BV  
Floridadreef 106  
3565 AM Utrecht,  
The Netherlands  
Tel: +31-30-261-96-56  
Fax: +31-30-261-96-57  
E-mail: [info@datavideo.nl](mailto:info@datavideo.nl)

**Singapore**  
Datavideo Visual Technology(S) Pte Ltd  
No. 178 Paya Lebar Road #06-07  
Singapore 409030  
Tel: +65-6749 6866  
Fax: +65-6749 3266  
E-mail: [info@datavideovirtualset.com](mailto:info@datavideovirtualset.com)

**Singapore**  
Datavideo Technologies (S) PTE Ltd  
No. 178 Paya Lebar Road #06-03  
Singapore 409030  
Tel: +65-6749 6866  
Fax: +65-6749 3266  
E-mail: [sales@datavideo.sg](mailto:sales@datavideo.sg)

**Taiwan**  
Datavideo Technologies Co. Ltd  
10F. No. 176, Jian 1st Rd., Chung Ho  
District, New Taipei City 235, Taiwan  
Tel: +886-2-8227-2888  
Fax: +886-2-8227-2777  
E-mail: [service@datavideo.com.tw](mailto:service@datavideo.com.tw)

**United States**  
Datavideo Corporation  
7048 Elmer Avenue.  
Whittier, CA 90602,  
U.S.A.  
Tel: +1-562-696 2324  
Fax: +1-562-698 6930  
E-mail: [sales@datavideo.com](mailto:sales@datavideo.com)

**United Kingdom**  
Datavideo UK Limited  
Brookfield House, Brookfield Industrial  
Estate, Peakdale Road, Glossop,  
Derbyshire, SK13 6LQ  
Tel: +44-1457 851 000  
Fax: +44-1457 850 964  
E-mail: [sales@datavideo.co.uk](mailto:sales@datavideo.co.uk)

**France**  
Datavideo France s.a.r.l.  
Cit  Descartes 1, rue Albert Einstein  
Champs sur Marne 774477 –  
Marne la Vall e cedex 2  
Tel: +33-1-60370246  
Fax: +33-1-60376732  
E-mail: [info@datavideo.fr](mailto:info@datavideo.fr)



Please visit our website for latest manual update.  
[www.datavideo.com/product/AD-200](http://www.datavideo.com/product/AD-200)

**datavideo**  
[www.datavideo.com](http://www.datavideo.com)