

OmniStream™ Single-Channel / Dual-Channel Networked AV Decoder



AT-OMNI-121
AT-OMNI-122

Atlona Manuals
Networked AV

Version Information

Version	Release Date	Notes
1	Apr 2017	Initial release
2	Jun 2017	New enclosure, documentation updates: AMS interface; front-panel buttons, decoder set tab
3	Dec 2017	Video wall configuration plus bezel compensation, slate / logo insertion, text insertion, redundancy grace period for IP input changes
4	May 2018	Updated to reflect AMS 2.0
5	Jul 2018	Includes updates to 1.2.1 firmware; AMS updates
6	Oct 2018	1.2.2 firmware; Dolby Vision decoding/licensing, fast switching
7	Aug 2019	Documentation updated to support AMS 2.4.0
8	Sep 2019	Documentation updated to support OmniStream 1.2.5; various bug fixes and added Portrait Mode (page 80) for Video Walls.
9	Oct 2019	Updated documentation to include support for Velocity 1.6.2 - Portrait orientation, rotation for Creating Presets (page 95) and Creating and Using Drop Zones (page 100).
10	Jan 2020	Velocity video wall screen shots updated to match Velocity 2.0.0.2.
11	Feb 2020	Added web server documentation reflecting changes to 1.2.6 firmware. Refer to the release notes for a complete listing features and bug fixes. - LLDP menu item added. Refer to the LLDP page (page 156).
12	Jan 2021	Firmware 1.2.7 - FPGA information now available under the System Information page. Refer to System information page (page 136) for more information. - NTP server set to <code>pool.ntp.org</code> , by default; change under the System Information page. Refer to System information page (page 136) for more information. - Custom SAP multicast address can now be configured under SAP page. Refer to SAP page (page 139) for more information. - Telnet session can now be disabled under the Network page. Refer to Network page (page 152) for more information. - Fast-switching timeout interval can now be set. Refer to Fast Switching (page 37) for more information. - Fast-switching now supports resolutions up to 1920x1200. - Output frame rate can now be adjusted. Refer to HDMI Output page (page 143) for more information.

Welcome to Atlona!

Thank you for purchasing this Atlona product. We hope you enjoy it and will take a extra few moments to register your new purchase.

Registration only takes a few minutes and protects this product against theft or loss. In addition, you will receive notifications of product updates and firmware. Atlona product registration is voluntary and failure to register will not affect the product warranty.

To register your product, go to <http://www.atlona.com/registration>

Sales, Marketing, and Customer Support

Main Office

Atlona Incorporated
70 Daggett Drive
San Jose, CA 95134
United States

Office: +1.877.536.3976 (US Toll-free)
Office: +1.408.962.0515 (US/International)

Sales and Customer Service Hours
Monday - Friday: 6:00 a.m. - 4:30 p.m. (PST)

<http://www.atlona.com/>

International Headquarters

Atlona International AG
Ringstrasse 15a
8600 Dübendorf
Switzerland

Office: +41 43 508 4321

Sales and Customer Service Hours
Monday - Friday: 09:00 - 17:00 (UTC +1)

Operating Notes

- The Atlona Management System (AMS) is a free downloadable application from Atlona that provides network configuration assistance for this product. This application is available only for the Windows® Operating System and can be downloaded from the Atlona web site.



IMPORTANT: Visit <http://www.atlona.com/product/AT-OMNI-121> and <http://www.atlona.com/product/AT-OMNI-122> for the latest firmware updates and User Manual.



NOTE: Scaling and deinterlacing is not supported at 1080i.

Atlona, Inc. (“Atlona”) Limited Product Warranty

Coverage

Atlona warrants its products will substantially perform to their published specifications and will be free from defects in materials and workmanship under normal use, conditions and service.

Under its Limited Product Warranty, Atlona, at its sole discretion, will either:

- repair or facilitate the repair of defective products within a reasonable period of time, restore products to their proper operating condition and return defective products free of any charge for necessary parts, labor and shipping.

OR

- replace and return, free of charge, any defective products with direct replacement or with similar products deemed by Atlona to perform substantially the same function as the original products.

OR

- refund the pro-rated value based on the remaining term of the warranty period, not to exceed MSRP, in cases where products are beyond repair and/or no direct or substantially similar replacement products exist.

Repair, replacement or refund of Atlona products is the purchaser’s exclusive remedy and Atlona liability does not extend to any other damages, incidental, consequential or otherwise.

This Limited Product Warranty extends to the original end-user purchaser of Atlona products and is non-transferrable to any subsequent purchaser(s) or owner(s) of these products.

Coverage Periods

Atlona Limited Product Warranty Period begins on the date of purchase by the end-purchaser. The date contained on the end-purchaser’s sales or delivery receipt is the proof purchase date.

Limited Product Warranty Terms – New Products

- 10 years from proof of purchase date for hardware/electronics products purchased on or after June 1, 2013.
- 3 years from proof of purchase date for hardware/electronics products purchased before June 1, 2013.
- Lifetime Limited Product Warranty for all cable products.

Limited Product Warranty Terms – Refurbished (B-Stock) Products and Discontinued Products

- 3 years from proof of purchase date for all Refurbished (B-Stock) and Discontinued hardware and electronic products purchased on or after June 1, 2013.

Remedy

Atlona recommends that end-purchasers contact their authorized Atlona dealer or reseller from whom they purchased their products. Atlona can also be contacted directly. Visit atlona.com for Atlona’s contact information and hours of operation. Atlona requires that a dated sales or delivery receipt from an authorized dealer, reseller or end-purchaser is provided before Atlona extends its warranty services. Additionally, a return merchandise authorization (RMA) and/or case number, is required to be obtained from Atlona in advance of returns.

Atlona requires that products returned are properly packed, preferably in the original carton, for shipping. Cartons not bearing a return authorization or case number will be refused. Atlona, at its sole discretion, reserves the right to reject any products received without advanced authorization. Authorizations can be requested by calling 1-877-536-3976 (US toll free) or 1-408- 962-0515 (US/international) or via Atlona’s website at atlona.com.

Exclusions

This Limited Product Warranty excludes:

- Damage, deterioration or malfunction caused by any alteration, modification, improper use, neglect, improper packaging or shipping (such claims must be presented to the carrier), lightning, power surges, or other acts of nature.

Atlona, Inc. (“Atlona”) Limited Product Warranty

- Damage, deterioration or malfunction resulting from the installation or removal of this product from any installation, any unauthorized tampering with this product, any repairs attempted by anyone unauthorized by Atlona to make such repairs, or any other cause which does not relate directly to a defect in materials and/or workmanship of this product.
- Equipment enclosures, cables, power supplies, batteries, LCD displays, and any accessories used in conjunction with the product(s).
- Products purchased from unauthorized distributors, dealers, resellers, auction websites and similar unauthorized channels of distribution.

Disclaimers

This Limited Product Warranty does not imply that the electronic components contained within Atlona’s products will not become obsolete nor does it imply Atlona products or their electronic components will remain compatible with any other current product, technology or any future products or technologies in which Atlona’s products may be used in conjunction with. Atlona, at its sole discretion, reserves the right not to extend its warranty offering in instances arising outside its normal course of business including, but not limited to, damage inflicted to its products from acts of god.

Limitation on Liability

The maximum liability of Atlona under this limited product warranty shall not exceed the original Atlona MSRP for its products. To the maximum extent permitted by law, Atlona is not responsible for the direct, special, incidental or consequential damages resulting from any breach of warranty or condition, or under any other legal theory. Some countries, districts or states do not allow the exclusion or limitation of relief, special, incidental, consequential or indirect damages, or the limitation of liability to specified amounts, so the above limitations or exclusions may not apply to you.

Exclusive Remedy

To the maximum extent permitted by law, this limited product warranty and the remedies set forth above are exclusive and in lieu of all other warranties, remedies and conditions, whether oral or written, express or implied. To the maximum extent permitted by law, Atlona specifically disclaims all implied warranties, including, without limitation, warranties of merchantability and fitness for a particular purpose. If Atlona cannot lawfully disclaim or exclude implied warranties under applicable law, then all implied warranties covering its products including warranties of merchantability and fitness for a particular purpose, shall provide to its products under applicable law. If any product to which this limited warranty applies is a “Consumer Product” under the Magnuson-Moss Warranty Act (15 U.S.C.A. §2301, ET SEQ.) or other applicable law, the foregoing disclaimer of implied warranties shall not apply, and all implied warranties on its products, including warranties of merchantability and fitness for the particular purpose, shall apply as provided under applicable law.

Other Conditions

Atlona’s Limited Product Warranty offering gives legal rights, and other rights may apply and vary from country to country or state to state. This limited warranty is void if (i) the label bearing the serial number of products have been removed or defaced, (ii) products are not purchased from an authorized Atlona dealer or reseller. A comprehensive list of Atlona’s authorized distributors, dealers and resellers can be found at www.atlona.com.

Safety and Certification



CAUTION: TO REDUCE THE RISK OF ELECTRIC SHOCK DO NOT OPEN ENCLOSURE OR EXPOSE TO RAIN OR MOISTURE. NO USER-SERVICEABLE PARTS INSIDE REFER SERVICING TO QUALIFIED SERVICE PERSONNEL.



The exclamation point within an equilateral triangle is intended to alert the user to the presence of important operating and maintenance instructions in the literature accompanying the product.



The information bubble is intended to alert the user to helpful or optional operational instructions in the literature accompanying the product.

1. Read these instructions.
2. Keep these instructions.
3. Heed all warnings.
4. Follow all instructions.
5. Do not use this product near water.
6. Clean only with a dry cloth.
7. Do not block any ventilation openings. Install in accordance with the manufacturer's instructions.
8. Do not install or place this product near any heat sources such as radiators, heat registers, stoves, or other apparatus (including amplifiers) that produce heat.

9. Do not defeat the safety purpose of a polarized or grounding-type plug. A polarized plug has two blades with one wider than the other. A grounding type plug has two blades and a third grounding prong. The wide blade or the third prong are provided for your safety. If the provided plug does not fit into your outlet, consult an electrician for replacement of the obsolete outlet.
10. Protect the power cord from being walked on or pinched particularly at plugs, convenience receptacles, and the point where they exit from the product.
11. Only use attachments/accessories specified by Atlona.
12. To reduce the risk of electric shock and/or damage to this product, never handle or touch this unit or power cord if your hands are wet or damp. Do not expose this product to rain or moisture.
13. Unplug this product during lightning storms or when unused for long periods of time.
14. Refer all servicing to qualified service personnel. Servicing is required when the product has been damaged in any way, such as power-supply cord or plug is damaged, liquid has been spilled or objects have fallen into the product, the product has been exposed to rain or moisture, does not operate normally, or has been dropped.



FCC Compliance

FCC Compliance and Advisory Statement: This hardware device complies with Part 15 of the FCC rules. Operation is subject to the following two conditions: 1) this device may not cause harmful interference, and 2) this device must accept any interference received including interference that may cause undesired operation. This equipment has been tested and found to comply with the limits for a Class A digital device, pursuant to Part 15 of the FCC Rules. These limits are designed to provide reasonable protection against harmful interference in a commercial installation. This equipment generates, uses, and can radiate radio frequency energy and, if not installed or used in accordance with the instructions, may cause harmful interference to radio communications. However there is no guarantee that interference will not occur in a particular installation. If this equipment does cause harmful interference to radio or television reception, which can be determined by turning the equipment off and on, the user is encouraged to try to correct the interference by one or more of the following measures: 1) reorient or relocate the receiving antenna; 2) increase the separation between the equipment and the receiver; 3) connect the equipment to an outlet on a circuit different from that to which the receiver is connected; 4) consult the dealer or an experienced radio/TV technician for help. Any changes or modifications not expressly approved by the party responsible for compliance could void the user's authority to operate the equipment. Where shielded interface cables have been provided with the product or specified additional components or accessories elsewhere defined to be used with the installation of the product, they must be used in order to ensure compliance with FCC regulations.

Copyright, Trademark, and Registration

© 2021 Atlona Inc. All rights reserved. "Atlona" and the Atlona logo are registered trademarks of Atlona Inc. Pricing, specifications and availability subject to change without notice. Actual products, product images, and online product images may vary from images shown here.

HDMI™ The terms HDMI, HDMI High-Definition Multimedia Interface, and the HDMI Logo are trademarks or registered trademarks of HDMI licensing Administrator, Inc.

All other trademark(s), copyright(s), and registered technologies mentioned in this document are the properties of their respective owner(s).

Table of Contents

Introduction	9
Features	9
Package Contents	9
Panel Description	10
AT-OMNI-121	10
AT-OMNI-122	11
Installation	12
External Power (Optional)	12
RS-232 Connections	13
IR Connections	14
Audio Connectors	15
Connection Instructions	17
Connection Diagram	18
Configuration	19
Accessing Decoders in AMS	19
Configuring a Static IP Address	22
Basic Operation	23
LED Indicators	23
Rebooting OmniStream	24
ID Button	24
Broadcast Messaging	24
Factory-Reset using the Front Panel	24
Factory-Reset using RS-232	25
Unicast Mode	26
Multicast Mode	28
Setting the Video Mode	30
Slate / Logo Insertion	31
Deleting Slates / Logos	34
Text Insertion	35
Fast Switching	37
IR Control	39
Controlling the Display using the Display's IR Remote	39
Required Equipment	40
Connecting the IR Receiver to the Encoder	40
Connecting the IR Emitter to the Decoder	41
Identifying the Encoder using AMS	42
Configuring the Encoder Serial Port	43
Configuring the Encoder Session	44
Configuring the Decoder Serial Port	46
Testing IR Functionality	49
Controlling the Display using a Control System	50
Using the Virtual Matrix	51
Advanced Operation	54
Configuring Audio Output	54
De-embedding Audio	54
Embedding Audio	55
Connecting RS-232 to OmniStream	56
Control Using RS-232	58
RS-232 Pass-Through	58
Triggering Stored Commands	58
Using TCP Proxy	59
Using the Virtual Matrix	60
802.1X Authentication	67
AES67 Audio	70

Table of Contents

Scrambling	71
Standard Method	71
Using the Virtual Matrix	72
Creating Video Walls	73
Introduction	73
Landscape Mode	74
Portrait Mode	80
Bezel Compensation	86
Video Walls using Velocity™	87
Creating Presets	95
Creating and Using Drop Zones	100
Custom Drop Zones	108
Configuring Redundant Streams	111
Redundancy Grace Period	112
The AMS Interface	113
Device Info page	113
IP Input page	116
HDMI Output page	118
Serial page	122
Network page	124
Other page	126
Logo	126
Text	127
PTP	128
SAP	129
The Virtual Matrix	130
Layout and Operation	131
Web Server	133
Accessing the Web Server	133
Getting the IP Address	133
Logging In	134
System information page	136
SAP page	139
IP Input page	140
Serial page	141
HDMI Output page	143
Logo page	148
Text page	150
Network page	152
PTP page	154
LLDP page	156
Configuration page	157
Users page	158
License page	159
Upgrade page	160
Appendix	161
Updating the Firmware using Velocity™/AMS	161
Updating the Firmware using the Web Server	164
FEC Details	165
Matrix Size, Overhead, and Latency	165
FEC and Video Bitrate	165
FEC, Latency, and Lip Sync	166
Mounting Instructions	167
Rack Tray for OmniStream	168
Specifications	169
Single-Channel Decoder	169
Dual-Channel Decoder	172

Introduction

The Atlona OmniStream™ 121 (AT-OMNI-121) is a networked AV decoder for one HDMI source up to 4K/UHD, plus embedded audio and RS-232 control. The Atlona OmniStream™ 122 (AT-OMNI-122) adds a second channel of encoding for two HDMI sources up to 4K/UHD and RS-232 control and can deliver duplicate AV streams to two networks for full system redundancy in mission-critical applications. OmniStream features SMPTE VC-2 compression for critical-quality video applications, with extremely low, sub-frame latency from encode to decode. It also includes selectable AES-128 encryption and SMPTE 2022-5 Forward Error Correction (FEC) for robust AV distribution spanning multiple networks. Both OmniStream decoders are housed in compact enclosures that easily fit into a half RU space. They can be powered over the network through Power over Ethernet (PoE) or optionally from local AC power.

OmniStream was engineered from the ground up at Atlona to deliver the performance and dependability of traditional AV distribution, with the virtually unlimited scalability and cost efficiency of integrating over data networks. It addresses the many challenges AV and IT integrators encounter with implementing networked AV systems, while delivering immediate and long-term ROI to end users in enterprises and other organizations.

Features

OmniStream Single-Channel Decoder

- Single-channel AV decoder for HDMI up to 4K/UHD
- Redundancy capabilities for mission critical applications
- SMPTE VC-2 compression
- RS-232 control
- Audio embedding / de-embedding
- Selectable AES-128 encryption
- SMPTE 2022-5 FEC
- Powered using PoE or optional external 48V DC power supply

OmniStream Dual-Channel Decoder

- Dual-channel AV decoder for HDMI up to 4K/UHD
- Redundancy capabilities for mission critical applications
- SMPTE VC-2 compression
- RS-232 control
- Audio embedding / de-embedding
- Selectable AES-128 encryption
- SMPTE 2022-5 FEC
- Powered using PoE or optional external 48V DC power supply

Package Contents

OmniStream Single-Channel Decoder

- 1 x AT-OMNI-121
- 1 x Captive screw connector, 3-pin
- 1 x Captive screw connector, 5-pin
- 1 x Push spring connector, 6-pin
- 2 x Push spring connectors, 5-pin
- 1 x Wall/table mounting brackets
- 1 x Installation Guide

OmniStream Dual-Channel Decoder

- 1 x AT-OMNI-122
- 1 x Push spring connector, 6-pin
- 1 x Captive screw connector, 3-pin
- 2 x Captive screw connectors, 5-pin
- 4 x Push spring connectors, 5-pin
- 1 x Wall/table mounting brackets
- 4 x Rubber feet
- 1 x Installation Guide

Panel Description

AT-OMNI-121

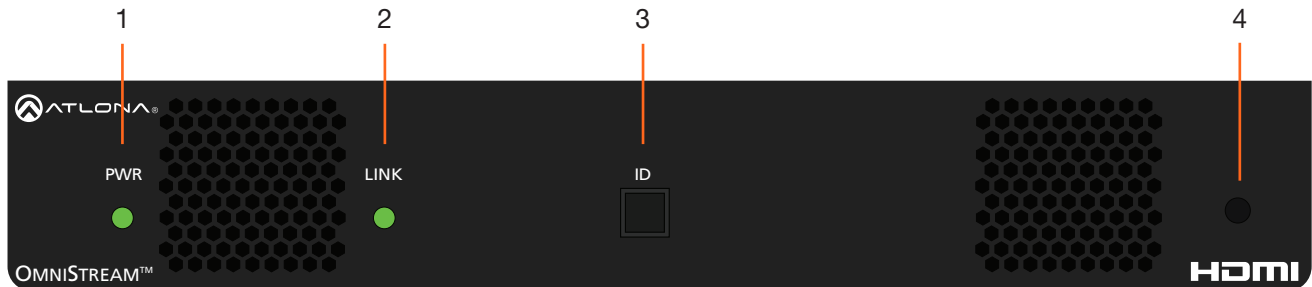

Front

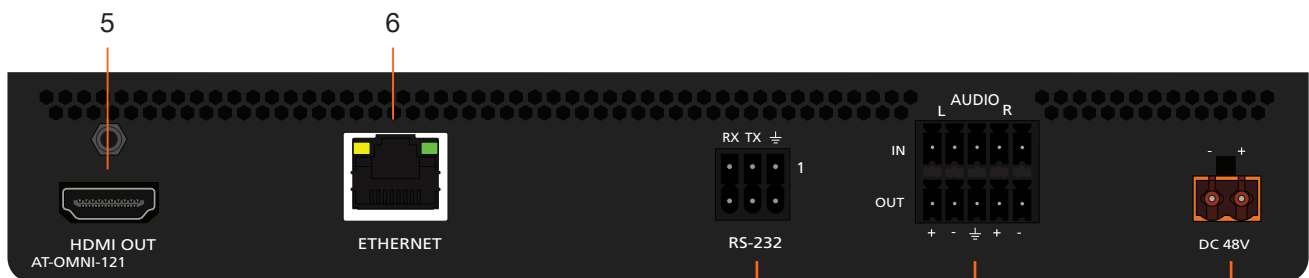

Rear

- | | |
|--|---|
| <p>1 PWR
This LED indicator is green when the unit is powered and booted.</p> <p>2 LINK
This LED indicator is green when the link integrity between the decoder and the network switch is good.</p> <p>3 ID
This button provides two functions:
(1) Press and release this button to send a broadcast network notification to any devices that may be listening (AMS).
(2) Press and hold this button for 30 seconds to perform a factory-reset of the unit. Refer to ID Button (page 24) for more information.</p> <p>4 REBOOT
Use a pointed object to press this recessed button and reboot the unit.</p> <p>5 HDMI OUT
Connect an HDMI cable from this port to a UHD/HD display.</p> | <p>6 ETHERNET
Connect an Ethernet cable from this port to the Local Area Network (LAN).</p> <p>7 RS-232
Use the included Phoenix terminal block to connect an RS-232 device to this port. The bottom three pins support IR pass-through. Refer to IR Connections (page 14) for more information.</p> <p>8 AUDIO
Connect the included Phoenix terminal blocks to embed audio on the output stream and/or connect to an audio output device.</p> <p>9 DC 48V
Connect the optional 48V DC power supply to this power receptacle. This power supply is available, separately.</p> |
|--|---|

AT-OMNI-122

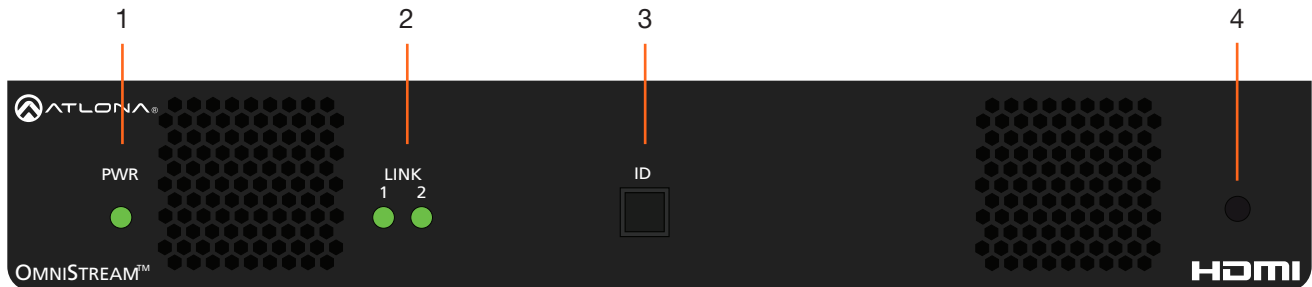

Front

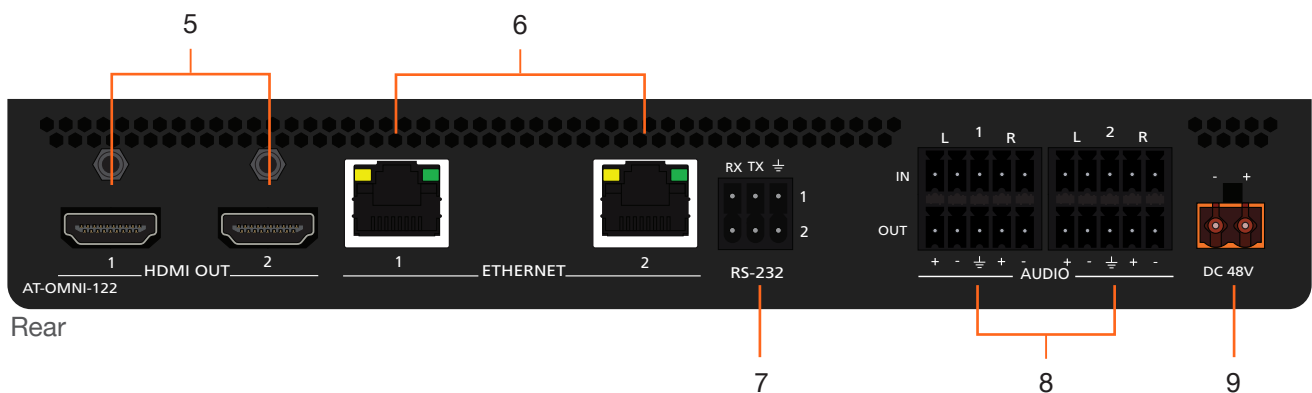

Rear

- | | |
|---|---|
| <p>1 PWR
This LED indicator is green when the unit is powered and booted.</p> <p>2 LINK 1 / LINK 2
These LED indicators will be green when the link integrity between the between the encoder and the network switch is good.</p> <p>3 ID
This button provides two functions:
(1) Press and release this button to send a broadcast network notification to any devices that may be listening (AMS).
(2) Press and hold this button for 30 seconds to perform a factory-reset of the unit. Refer to ID Button (page 24) for more information.</p> <p>4 REBOOT
Use a pointed object to press this recessed button and reboot the unit.</p> <p>5 HDMI OUT 1 / HDMI OUT 2
Connect HDMI cables from these ports to a UHD/HD display.</p> | <p>6 ETHERNET 1 / ETHERNET 2
Connect Ethernet cables from these ports to the Local Area Network (LAN).</p> <p>7 RS-232
Use the included Euroblock push-spring connector to connect up to two RS-232 devices to this port. The RS-232 2 port also supports IR pass-through. Refer to IR Connections (page 14) for more information.</p> <p>8 AUDIO 1 / AUDIO 2
Connect the included Euroblock push-spring connectors to embed audio on the output stream and/or connect to an audio output device.</p> <p>9 DC 48V
Connect the optional 48V DC power supply to this power receptacle. This power supply is available, separately, and is required when connecting the encoder to non-PoE compatible switch or when embedding and de-embedding of analog audio.</p> |
|---|---|

Installation

External Power (Optional)

OmniStream decoders are powered by PoE (Power over Ethernet), when connected to a PoE-capable switch. If a PoE-switch is not used, then the optional 48 V power supply (Atlona part no. AT-PS-48083-C) can be purchased, separately. Insert the positive and negative leads, from the power supply, into the terminals of the 2-pin captive screw connector block, as shown. The orange 2-pin captive screw connector block is included with the OmniStream power supply package.



IMPORTANT: The external power supply must be connected to the decoder when embedding and de-embedding audio using the **AUDIO IN** and/or **AUDIO OUT** ports.

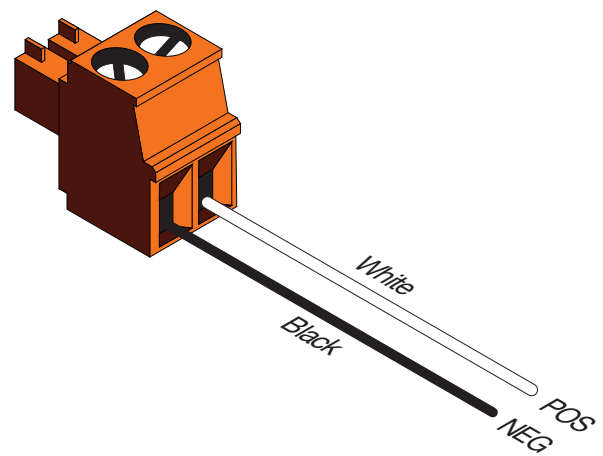
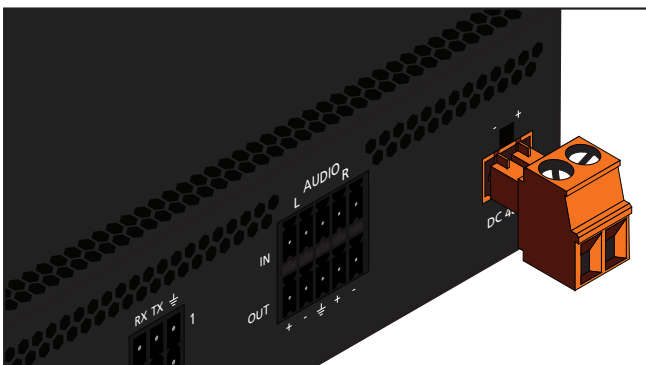

RS-232 Connections

Both the AT-OMNI-121 and AT-OMNI-122 provide RS-232 over IP, allowing communication between an automation system and an RS-232 device. This step is optional. Note that different Phoenix connectors are provided with each product.

1. Use wire strippers to remove a portion of the cable jacket.
2. Remove at least 3/16" (5 mm) from the insulation of the RX, TX, and GND wires.
3. Insert the TX, RX, and GND wires into correct terminal on the included Phoenix block. If using non-tinned stranded wire, press the orange tab, above the terminal, while inserting the exposed wire. Repeat this step for the TX, RX, and GND connections.

AT-OMNI-121

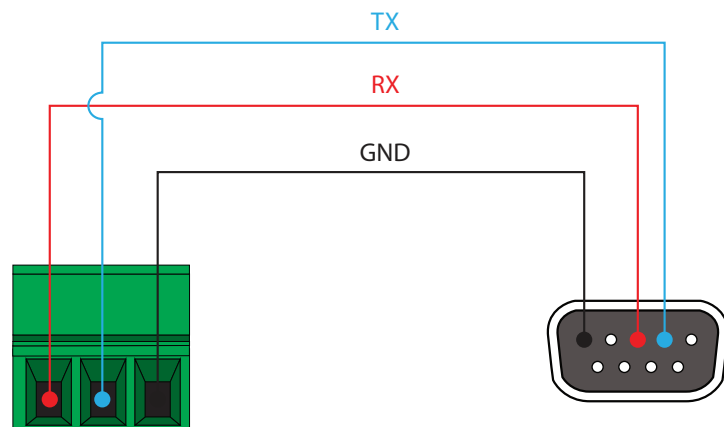
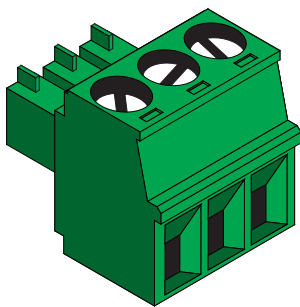

AT-OMNI-122

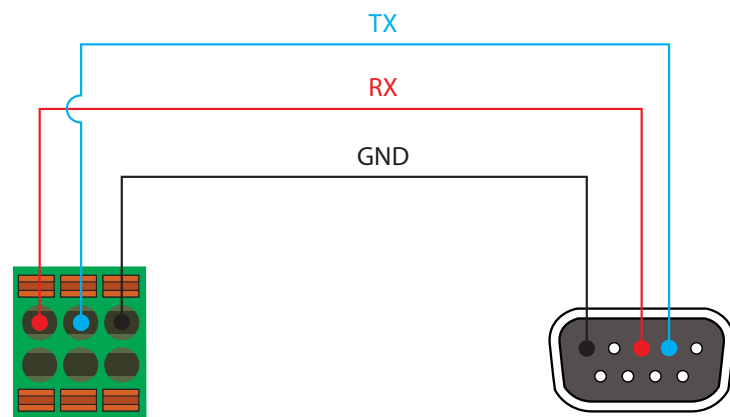
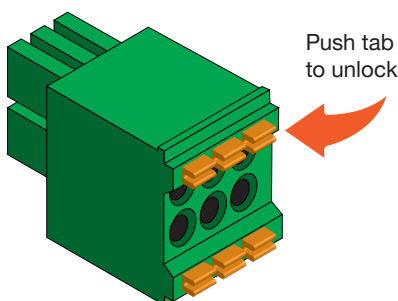

NOTE: Typical DB9 connectors use pin 2 for TX, pin 3 for RX, and pin 5 for ground. On some devices, pins 2 and 3 are reversed.

IR Connections

The same port that provides RS-232 connections also supports bidirectional IR pass-through, allowing a device to be controlled from either the headend or the decoder endpoint. This step is optional. Either the top three or bottom three set of terminals can be used for IR. Only the **RS-232 2** port (bottom set of connectors) supports both RS-232 and IR. Therefore, this port must be used for IR connections. Refer to [IR Control \(page 39\)](#) for more information.

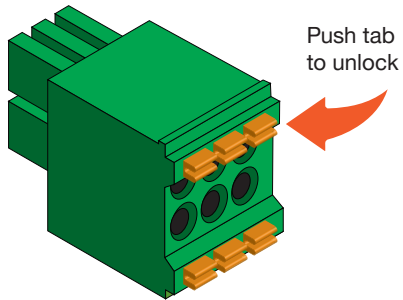

IR emitter configuration

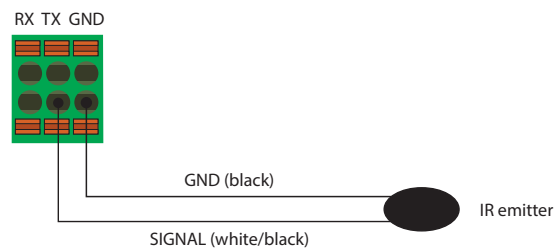

IR extender configuration

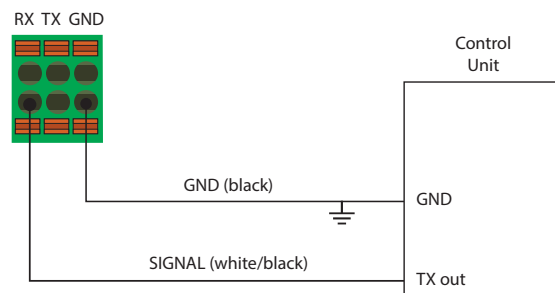

Audio Connectors

In addition to passing audio directly from the encoder to the decoder, both the AT-OMNI-121 and AT-OMNI-122 provide two additional audio options. Either option can be used or they can be used simultaneously.

- HDMI audio can be de-embedded and output to two-channel analog audio.
- Two-channel analog audio can be embedded and output over HDMI.

Use the included dual five-pin Phoenix blocks. Note that each product comes with different connector blocks. This step is optional. Refer to [Configuring Audio Output \(page 54\)](#) for more information.

AT-OMNI-121

- If either the **AUDIO IN** or **AUDIO OUT** port will be used, then connect the included 5-pin “captive screw” Phoenix blocks, as shown below.

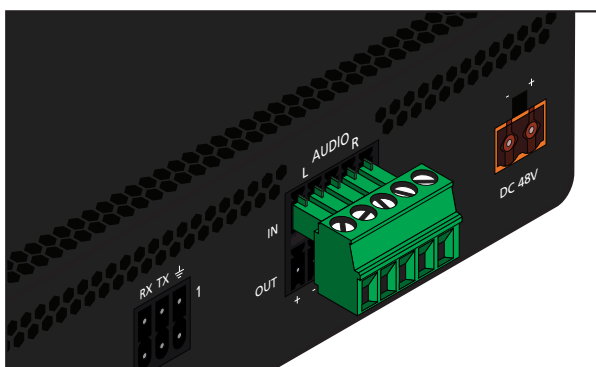

2-channel analog audio input (top)

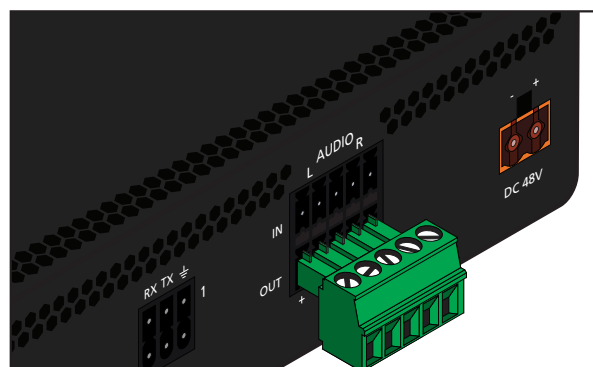

2-channel analog audio output (bottom)

- If *both* **AUDIO IN** and **AUDIO OUT** terminals will be used, then connect the included 5-pin “push spring” Phoenix blocks, as shown below.

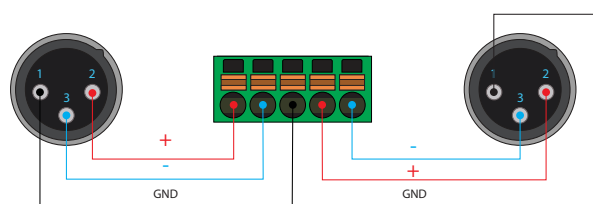
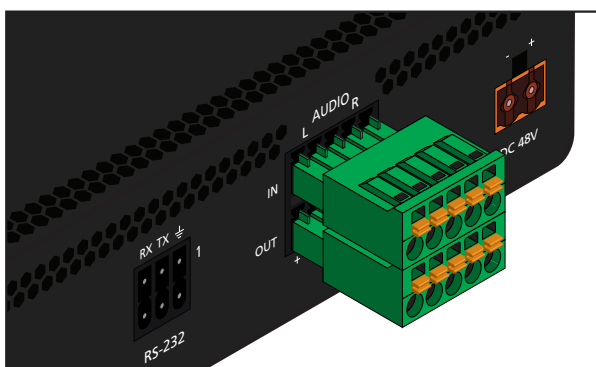

Balanced XLR audio

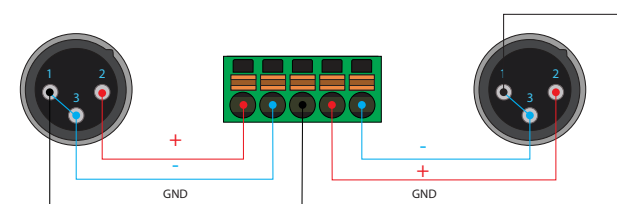

Unbalanced XLR audio

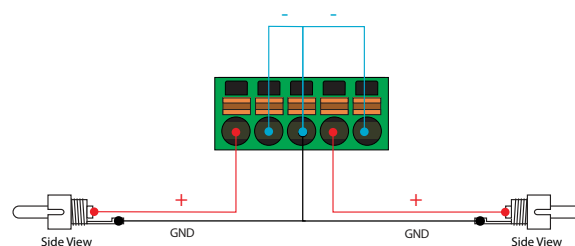

Unbalanced RCA audio



NOTE: Unbalanced XLR audio pins require Pin 1 and Pin 3 to be connected.

AT-OMNI-122

Use the top 5 pins to connect audio input sources. Use the bottom five pins to connect to audio output devices.

1. Use wire strippers to remove a portion of the cable jacket.
2. Locate the included Phoenix block connectors. Press the orange tab, above the terminal, while inserting the exposed wire. Release the orange tab to lock the wire in place. Balanced or unbalanced audio can be used.

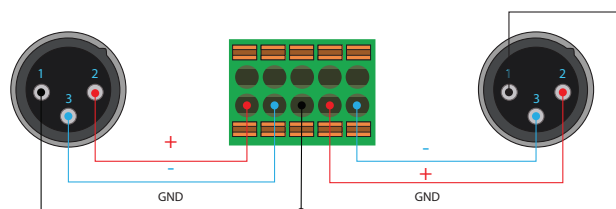
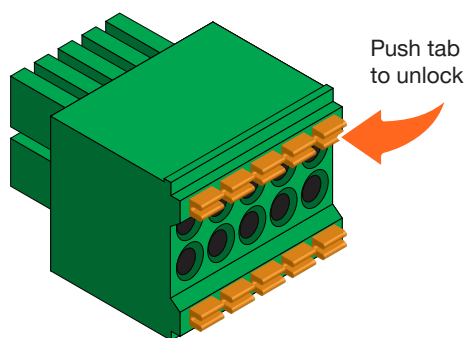

Balanced XLR audio

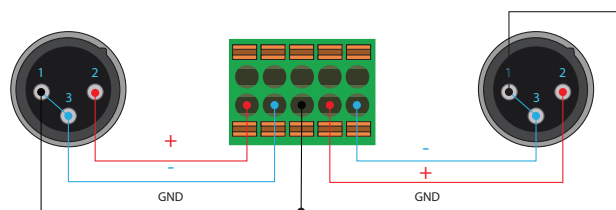

Unbalanced XLR audio

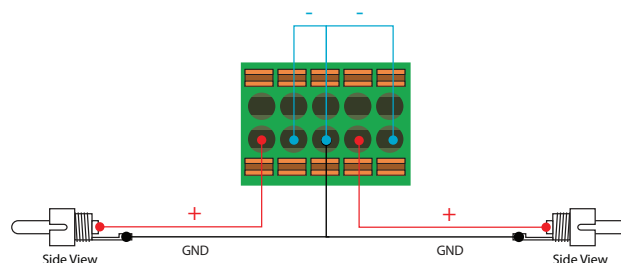

Unbalanced RCA audio



NOTE: Unbalanced XLR audio pins require Pin 1 and Pin 3 to be connected.



IMPORTANT: When using analog audio inputs on the OmniStream decoder, the decoder must be powered using the 48V power supply (AT-PS-48083-C). This power supply is sold separately and can be purchased from Atlona.

Connection Instructions

1. Connect an Ethernet cable from the **ETHERNET** port on the decoder to a PoE-capable switch on the Local Area Network (LAN). If using the dual-channel decoder, connect a separate Ethernet cables to **ETHERNET 1** and **ETHERNET 2** ports.



IMPORTANT: If a PoE-capable switch is not available, then the 48V DC power supply (sold separately) must be connected to the decoder.

2. Connect an HDMI cable from the **HDMI OUT** port on the decoder to a display. If using the dual-channel decoder, connect an HDMI cable from each **HDMI OUT** port to a display.
3. RS-232 (optional)
 - Connect the RS-232 controller/automation system to the **RS-232** port on the decoder.
 - Connect the RS-232 device to the **RS-232** port on the decoder.
4. External Audio (optional)
 - Connect the audio inputs to the decoder, as required.
 - Connect the audio outputs to the decoder, as required.



IMPORTANT: When using analog audio inputs on the OmniStream decoder, the decoder must be powered using the 48V power supply (AT-PS-48083-C). This power supply is sold separately and can be purchased from Atlona.

5. IR (optional)



NOTE: For dual-channel decoders, only the **RS-232 2** port supports both serial and IR. Single-channel decoders only support IR on the **RS-232 2** port. The IR emitter or IR receiver must always be connected to this port. Refer to [IR Control \(page 39\)](#) for more information.

- **IR emitter**
Connect the IR emitter to the **TX** and **GND** pins of the **RS-232 2** port. The IR emitter must be placed no more than one inch from the IR sensor on the device, in order to function properly.
 - **IR extender**
Connect the IR extender from the **RX** and **GND** pins of the **RS-232 2** port to the associated pins on the control system.
6. Once power is applied, the **PWR** indicator, on the front panel, will turn red, then amber, then green.

Connection Diagram

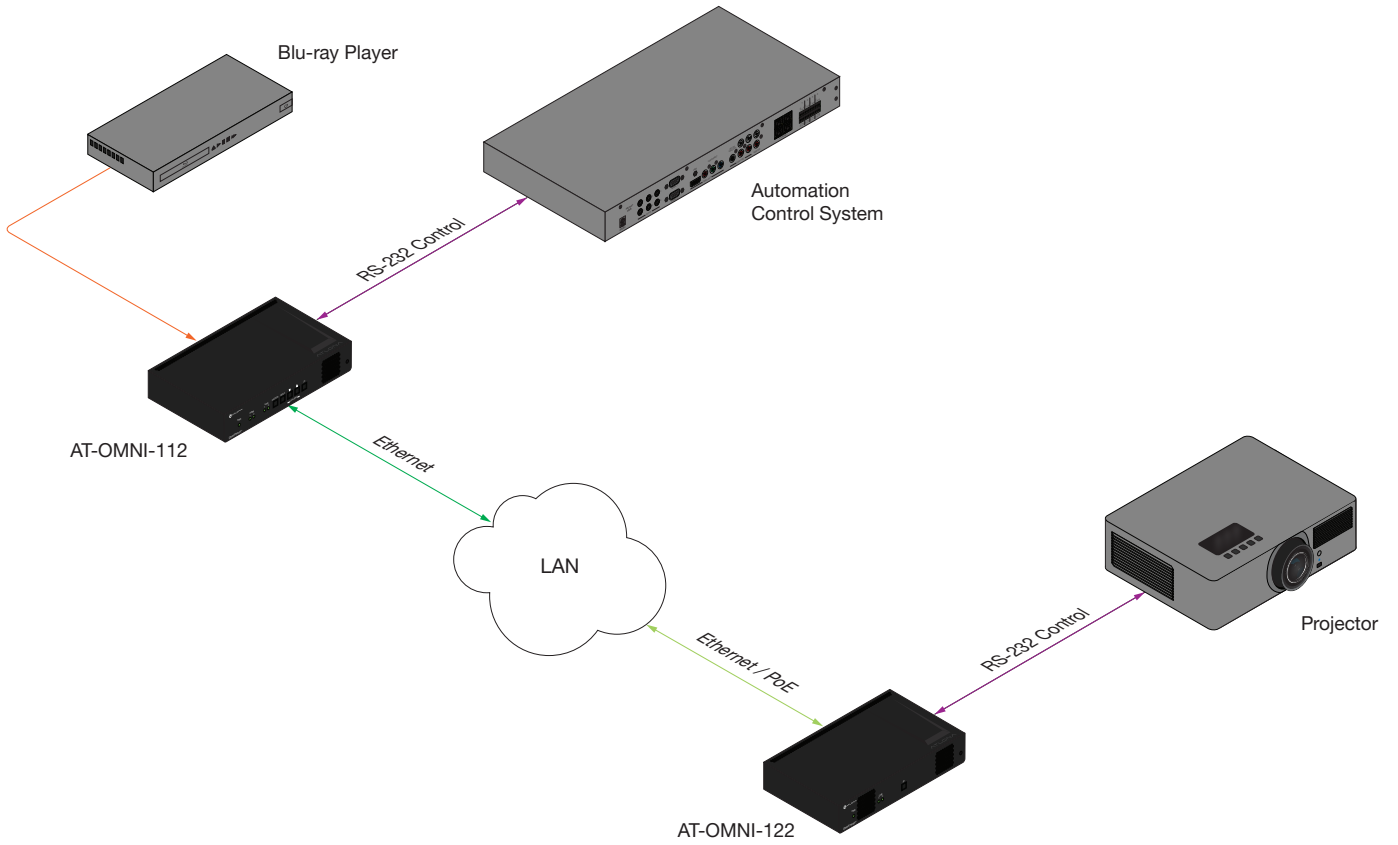

Configuration

Accessing Decoders in AMS

It is recommended that the Atlona Management System (AMS) be used to configure and control OmniStream devices. AMS uses multicast Domain Name Server (mDNS) to automatically configure each decoder on the network. AMS is free and can be downloaded from <https://www.atlona.com/ams>.

By default, the decoders are set to DHCP mode, allowing a DHCP server (if present) to assign the decoder an IP address. Once an IP address has been assigned, the Atlona Management System (AMS) can be used to manage the product on the network. Note that AMS will only be able to discover decoders if they are on the same VLAN.

1. Launch a web browser and enter the IP address of AMS, in the address bar.
2. Enter the required login credentials. The default login is:

Username: admin
Password: Atlona

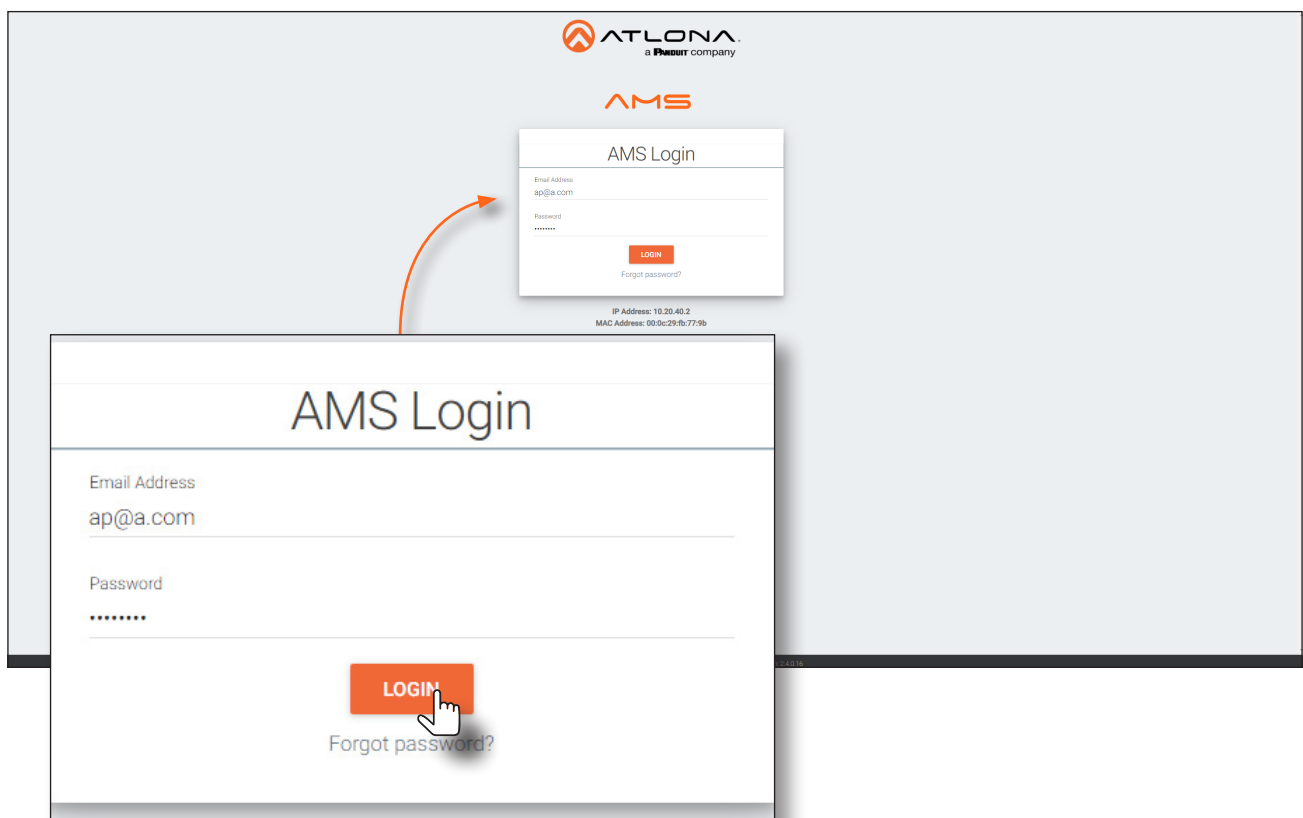

3. Click the **Login** button.
4. The AMS Dashboard will be displayed.
5. Click the  icon, in the upper-left corner of the AMS Dashboard.

6. Click **Devices** from the fly-out menu.

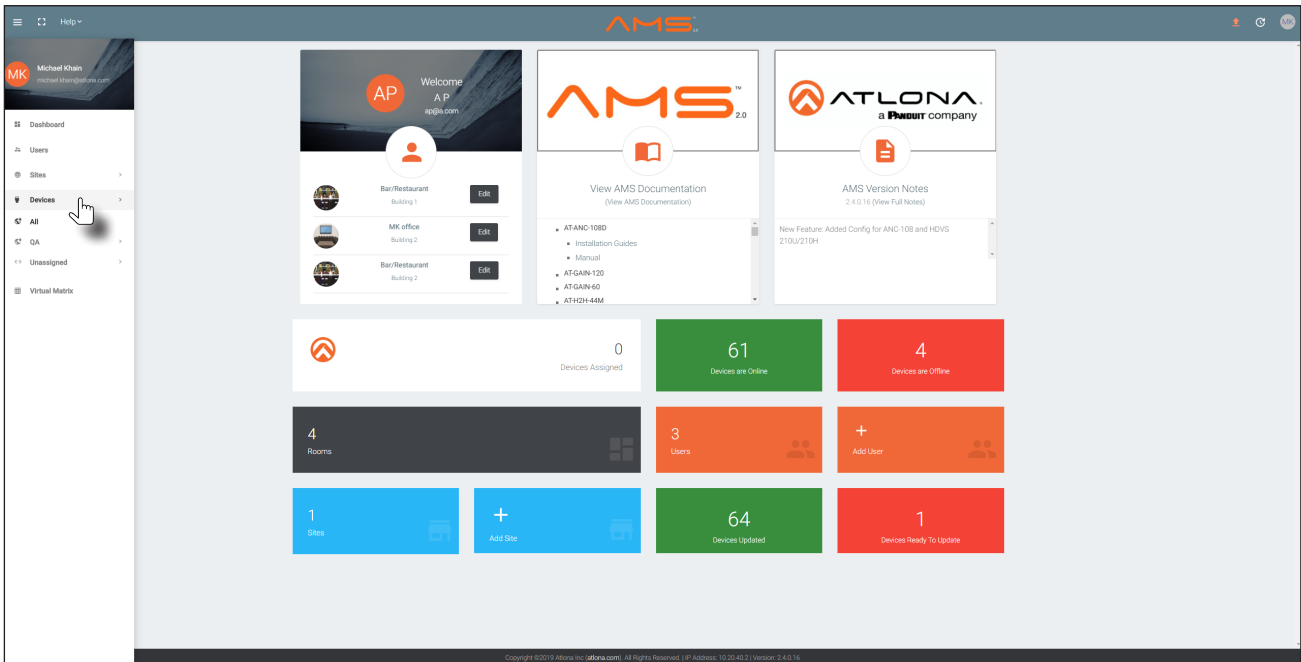

7. Click the **Unassigned** option.

8. Click the left and right arrows, at the bottom of the **Unassigned** list, to scroll through all available devices.

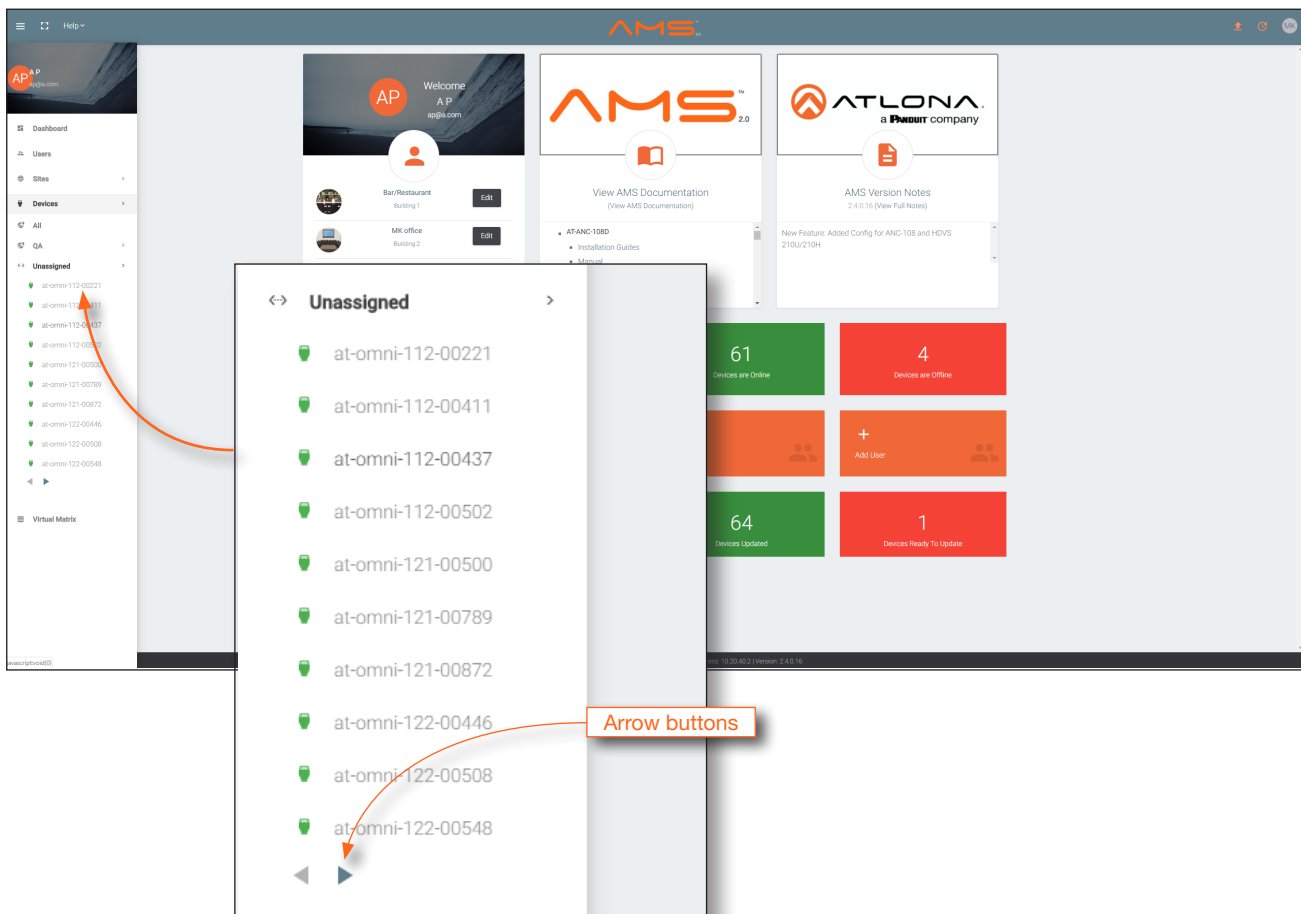

All available decoders will be displayed under the **Unassigned** category. When a decoder is unassigned, it means that it has not been assigned to a site, building, and/or room. Refer to the AMS User Manual for more information on these topics.

If a DHCP server is not found within 60 seconds, the decoder will be placed in Auto IP mode and assigned an IP address within the range of 169.254.xxx.xxx. If this occurs, configure the network interface of the computer that is running AMS, located on the same subnet (169.254.xxx.xxx, subnet mask 255.255.0.0). Refer to the User Manual for more information on configuring a decoder in Auto IP mode.

If no OmniStream decoders are found, then verify the following:

- The computer that is running AMS must be on the same network as the OmniStream device.
- Remove any network restrictions that may be in place. In order for mDNS to function properly, there must not be restrictions applied to the network.

9. Click the desired encoder within the **Unassigned** list.

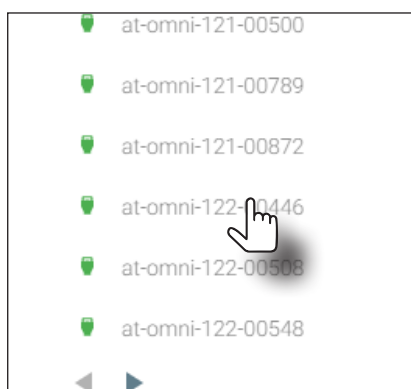

10. Once the unit is selected, the control interface for the decoder will be displayed. The illustration below shows the **DEVICE INFO** screen for an AT-OMNI-122 decoder.

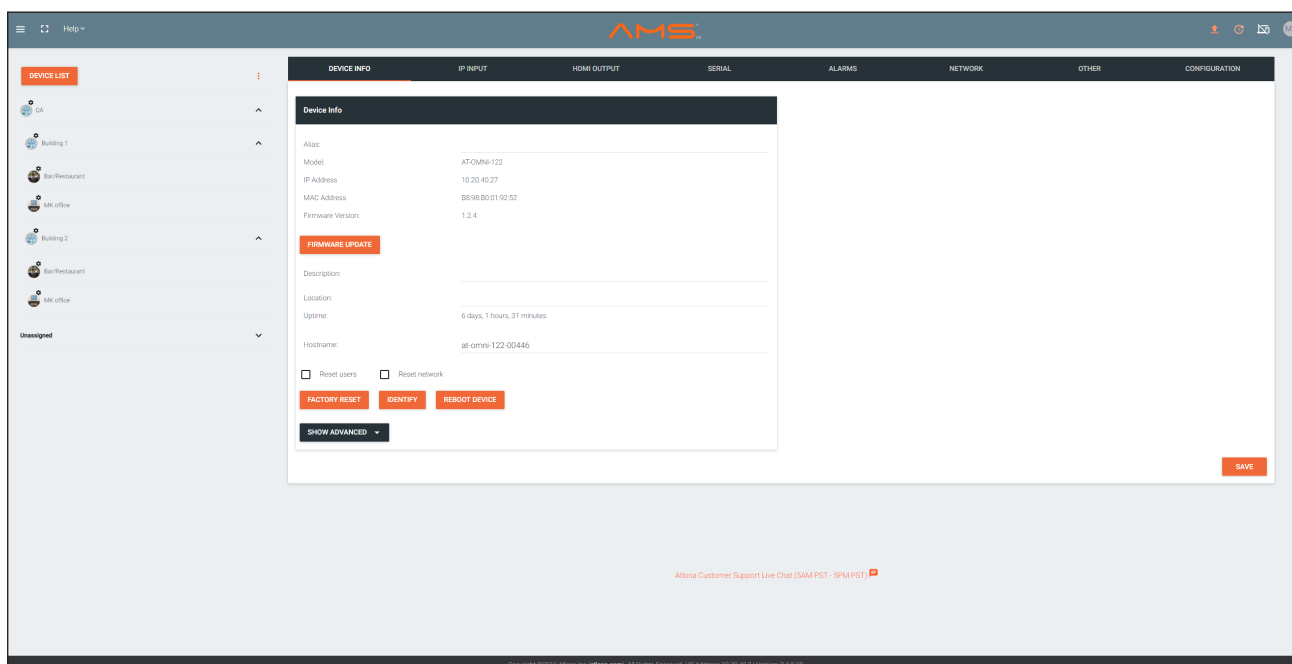

Configuring a Static IP Address

The following section is only required to set the decoder, currently in Auto IP mode, to a static IP address. If a DHCP server is not found within 60 seconds, decoders are automatically placed in Auto IP mode and will be assigned an IP address within the range 169.254.xxx.xxx. If this occurs, a static IP address can be assigned to the decoder in order for AMS to locate it on the network.

1. Make sure that the decoder is powered. Power will need to be supplied either by the external 48V power supply (not included) or by connecting an Ethernet cable from the decoder to a PoE-capable switch. If using the AT-OMNI-122, the Ethernet cable can be connected to either **ETHERNET 1** or **ETHERNET 2** (dual-channel only).
2. Connect an Ethernet cable from the PC, directly to one of the Ethernet ports on the decoder. Make sure that the computer being used has AMS installed.
3. Configure the PC to a static IP address that is on the same subnet as the decoder.



IMPORTANT: Before continuing, write down the current IP settings in order to restore them, later. If *Obtain an IP address automatically* and *Obtain DNS server automatically* are selected, then this step is not required.

4. Login to AMS. Refer to [Accessing Decoders in AMS \(page 19\)](#) if necessary.
5. Locate the decoder under the **Unassigned** section within AMS.
6. Click on the device.
7. Under AMS, click the **NETWORK** tab.

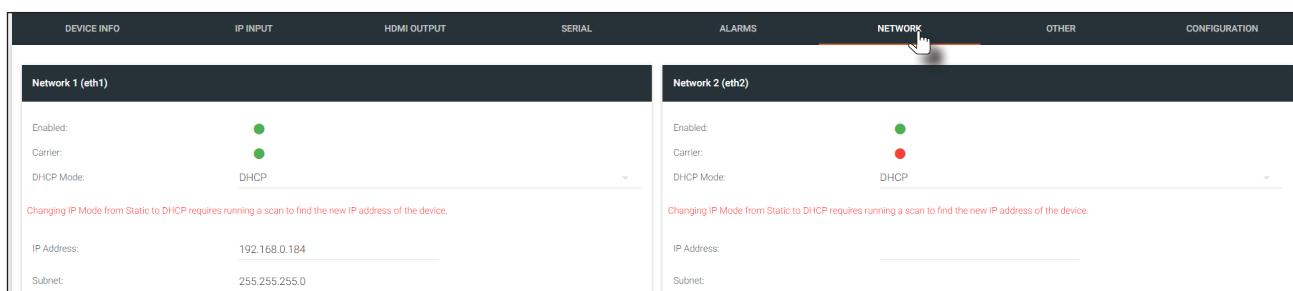

8. Click the **DHCP Mode** drop-down list and select **Static**.

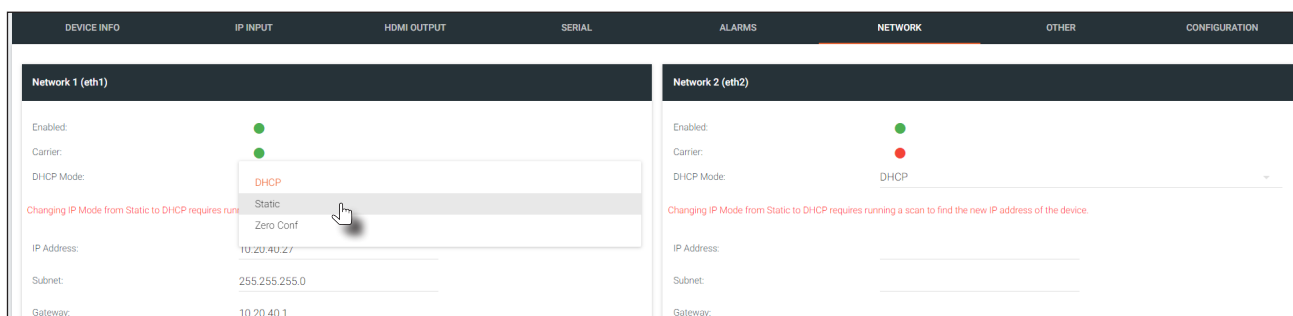

9. Enter the required network information for the decoder in the **IP Address**, **Subnet**, and **Gateway** fields.
10. Click the **Save** button in the bottom-right corner, to apply the changes.
11. Disconnect the decoder from the PC and connect it to the network.
12. The decoder is now ready for use.

Basic Operation

LED Indicators

The following table provides a listing of front-panel LED indicators and their status:

LED		Description
PWR	Off	○
	Red	●
	Green	●
LINK 1 / 2	Red	●
	Green	●

Rebooting OmniStream

To reboot the OmniStream decoder, press and release the recessed button, on the far-right side of the unit, using a small, pointed object. Rebooting the decoder does not reset the decoder to factory-default settings.

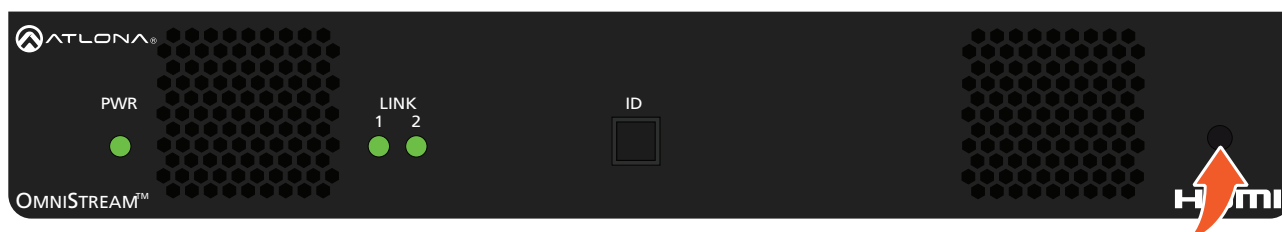

ID Button

This feature is not available on the single-channel OmniStream decoder (AT-OMNI-121).

The **ID** button serves two functions:

1. Sends a broadcast message, over the network, to any devices that may be listening.
2. Resets the decoder to factory-default settings.

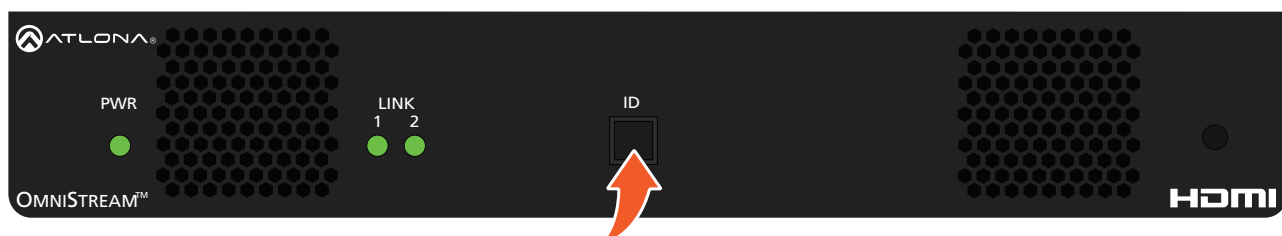

Broadcast Messaging

Press and release the **ID** button to send a broadcast notification over the network to any devices that may be listening.

Factory-Reset using the Front Panel



WARNING: Performing a factory-default reset will erase all user-programmed settings from the decoder. IP settings are not preserved.

1. Press and hold the **ID** button for approximately 30 seconds.
2. The LED indicators on the front panel will flash, then turn “off.”
3. The decoder is now reset and will need to be reconfigured.

Factory-Reset using RS-232

1. Connect a USB to RS-232 cable from the computer to the OmniStream decoder. Refer to [Connecting RS-232 to OmniStream \(page 56\)](#) for information on preparing a cable and connecting to OmniStream units.
2. Launch a terminal program that supports RS-232, such as PuTTY. PuTTY is a free and open-source terminal emulator and can be downloaded from <https://www.putty.org>. The following example uses PuTTY.

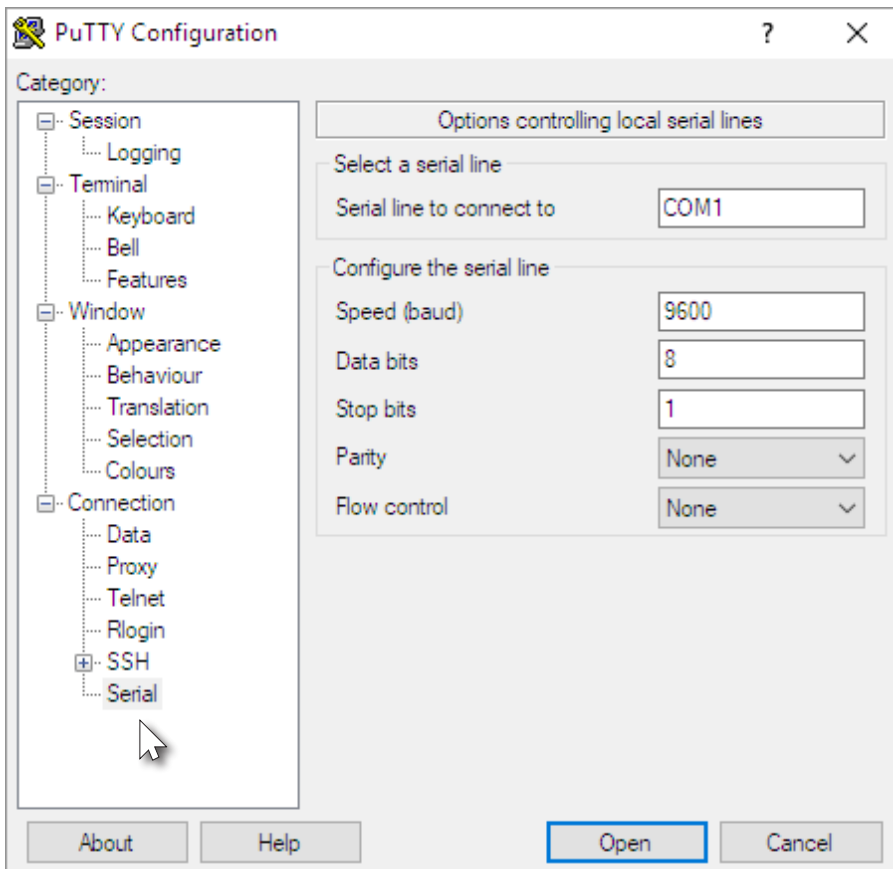

3. Click **Serial**, near the bottom on the left-hand side pane.
4. Enter the COM port in the **Serial line to connect to** field. This is the COM port used by the computer, to communicate with the OmniStream decoder. Refer to [Connecting RS-232 to OmniStream \(page 56\)](#) for more information on obtaining the proper COM port.
5. Enter the baud rate, data bits, and stop bits as follows: 9600, 8, 1.
6. Click the Parity drop-down list and select **None**. Click the Flow control drop-down list and select **None**.
7. Click **Open** to establish the RS-232 connection.
8. Enter the login credentials. The default login credentials are listed below. Note that login information is case-sensitive.

```
username: admin
password: Atlona
```
9. Once connected, the CLI (Command Line Interface) will be displayed. Execute the following command and press [ENTER]:

```
Mreset
```

Unicast Mode

The term *unicast* is used to describe a configuration where information is sent from an encoder to a single decoder. Although it is common to have multiple encoder and decoder units within a system, it may also be desirable to restrict a single encoder to communicate with one decoder. In *unicast* mode, OmniStream encoders and decoders function similar to an n x 1 switcher. Changing the destination IP address at the encoder, will direct the stream to be received by a different decoder.

The illustration below shows three encoders and three decoders on a network, operating in *unicast* mode. The red lines indicate the data paths from each encoder to a separate (single) decoder.



NOTE: By default, both encoders and decoders are shipped in multicast mode.

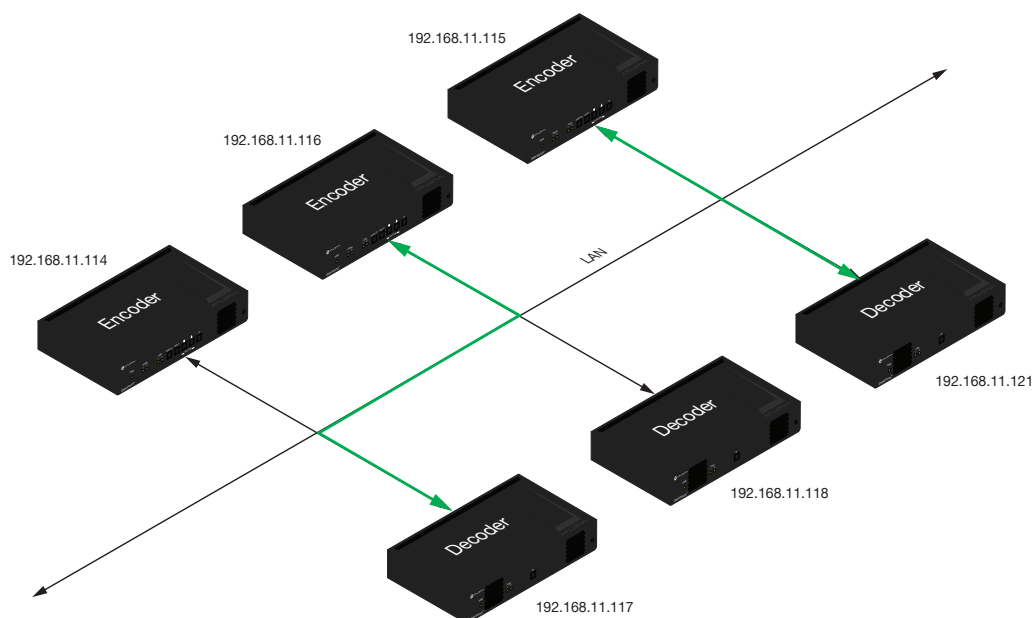

1. Login to AMS. Refer to [Accessing Decoders in AMS \(page 19\)](#) if necessary.
2. Go to the encoder AMS interface. Refer to the *OmniStream Single-Channel / Dual Channel A/V Encoder User Manual*, if necessary.
3. Click **SESSION** in the menu bar and locate the **Video** section.
4. Enter the IP address of the decoder in the **Destination Multicast/Unicast Address** field. If using dual-channel encoders, repeat this process for each stream.

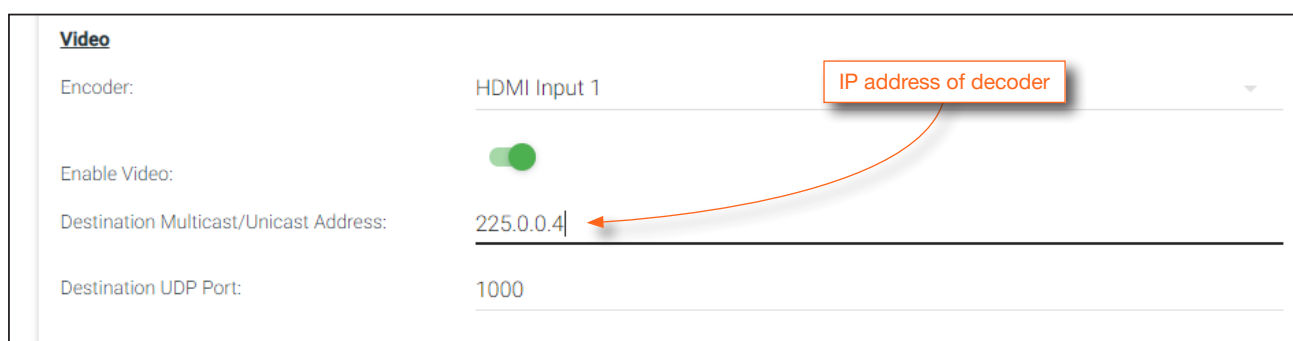

The screenshot shows the 'Video' configuration page in the AMS interface. The 'Encoder' is set to 'HDMI Input 1'. The 'Enable Video' toggle is turned on. The 'Destination Multicast/Unicast Address' field is set to '225.0.0.4', with a callout box pointing to it that says 'IP address of decoder'. The 'Destination UDP Port' is set to '1000'.

5. Scroll down to the bottom of the page and click the **SAVE** button to commit all changes.

6. Go to the decoder AMS interface.
7. Click **IP INPUT** from the menu.
8. Remove the IP address from the **Multicast Address** field.
9. Click the **SAVE** button to commit changes.

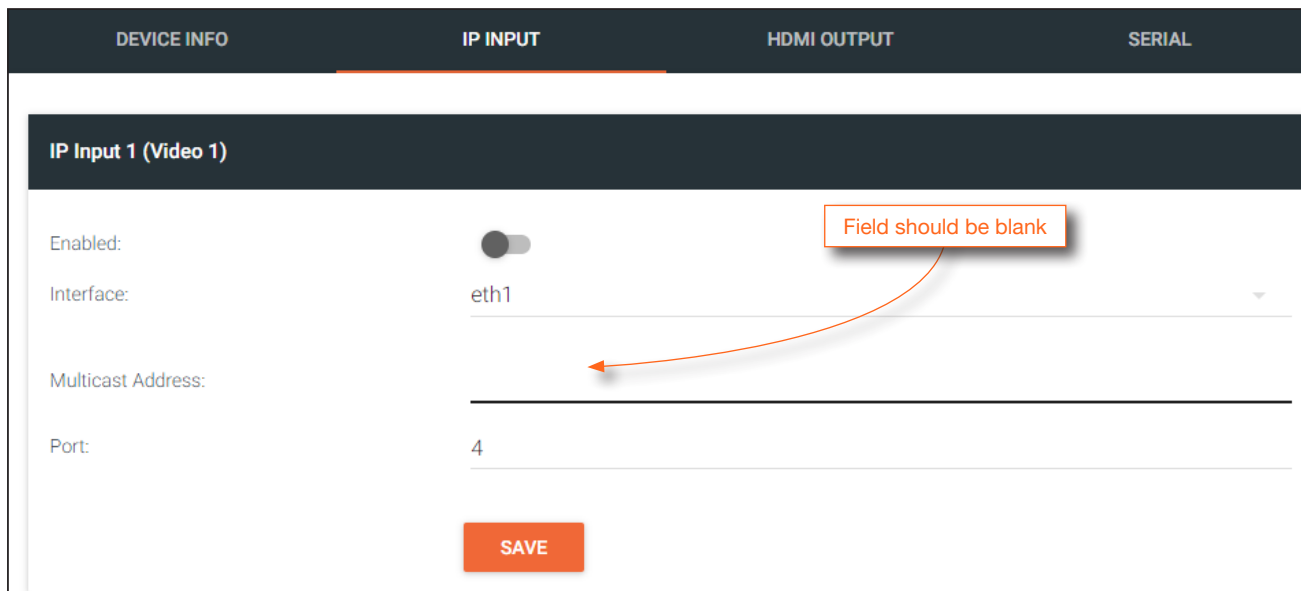

The screenshot shows the configuration page for 'IP Input 1 (Video 1)'. At the top, there are four tabs: 'DEVICE INFO', 'IP INPUT', 'HDMI OUTPUT', and 'SERIAL'. The 'IP INPUT' tab is selected. Below the tabs, the configuration options are:

- Enabled:** A toggle switch that is currently turned on.
- Interface:** A dropdown menu showing 'eth1'.
- Multicast Address:** An empty text input field. A red callout box with the text 'Field should be blank' and an arrow points to this field.
- Port:** A text input field containing the number '4'.

At the bottom of the configuration area, there is an orange 'SAVE' button.

10. Unicast setup is complete. The decoder unit will now receive streams exclusively from the encoder containing the IP address of this decoder.

Multicast Mode

The term *multicast* is used to describe a configuration where information is sent from one or more points to a set of other points. For example, a single encoder can transmit data to multiple decoders. In addition, if multiple encoders are used, each encoder can stream data to any decoder that is not already receiving data from an encoder. In *multicast* mode, OmniStream encoders and decoders function similar to a matrix switcher.

The illustration below shows three encoders and three decoders on a network, operating in *multicast* mode, where multiple decoders are subscribed to a single encoder. The red lines indicate the data paths from an encoder (192.168.11.117) to multiple decoders.



NOTE: By default, both encoders and decoders are shipped in multicast mode.

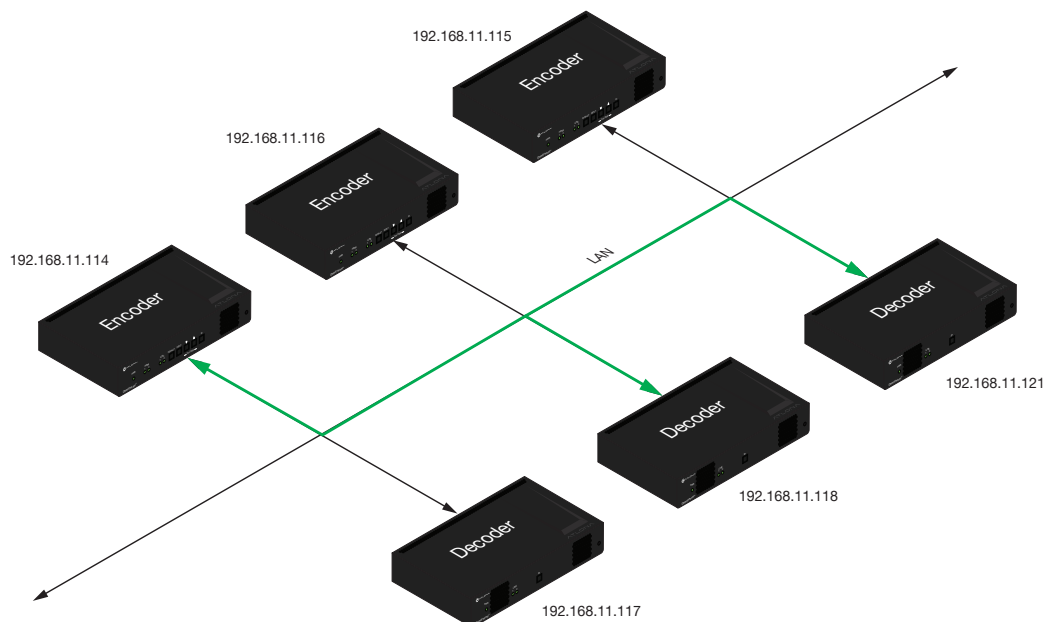

1. Login to AMS. Refer to [Accessing Decoders in AMS \(page 19\)](#) if necessary.
2. The AMS Dashboard will be displayed.
3. Click the  icon, in the upper-left corner of the AMS Dashboard.
4. Click **Virtual Matrix** from the fly-out menu. Refer to [The Virtual Matrix \(page 130\)](#), if necessary.
5. Locate the desired encoder in the Virtual Matrix, as shown on the next page.
6. Create a cross-connection to the desired decoder. When a cross-connection is created, AMS will automatically assign a multicast IP address to both the encoder and decoder. By default, AMS automatically assigns a multicast IP address to each OmniStream encoder and decoder.

Refer to the illustration on the following page, if necessary.

OmniStream Virtual Matrix

Encoders / Decoders LEGEND

Encoder / Decoder	IP Address	Status	AT-OMNI-121	Andrew's AT-OMNI-122	AT-OMNI-122	AT-OMNI-521
AT-OMNI-121 192.168.11.34 at-omni-121-00461	192.168.11.34	Connected	HDMI 1	HDMI 1	HDMI 2	HDMI 1
Andrew's AT-OMNI-122 192.168.11.117 at-omni-122-00548	192.168.11.117	Connected	HDMI 1	HDMI 2	HDMI 1	HDMI 2
AT-OMNI-122 192.168.11.86 192.168.11.87 at-omni-122-00242	192.168.11.86 192.168.11.87	Connected	HDMI 1	HDMI 2	HDMI 1	HDMI 2
AT-OMNI-521 192.168.11.39 at-omni-521-00064	192.168.11.39	Connected	HDMI 1	HDMI 2	HDMI 1	HDMI 2
AT-OMNI-111 192.168.11.50 at-omni-111-00200	192.168.11.50	Connected	HDMI 1			
AT-OMNI-112 192.168.11.178 at-omni-112-00349	192.168.11.178	Connected	HDMI 1			
Andrew's AT-OMNI-112 192.168.11.116 at-omni-112-00722	192.168.11.116	Connected	HDMI 1			
AT-OMNI-112 192.168.11.178 at-omni-112-00349	192.168.11.178	Connected	HDMI 2			
Andrew's AT-OMNI-112 192.168.11.116 at-omni-112-00722	192.168.11.116	Connected	HDMI 2			

Legend: Green checkmark = Connected, Blue checkmark = Options, Red checkmark = Options

Matrix: A grid of dashed squares representing connections between encoders and decoders. A red arrow points from a green checkmark in the matrix to a detailed view of a connection.

Connection Detail: A green checkmark icon with a hand cursor pointing to it, indicating a successful connection.

Setting the Video Mode

OmniStream offers two video modes: Video and PC application. These two modes will optimize the image, based on the type of information that is being displayed. Use the **Video** mode when display motion graphics/video. Set this mode to **PC application** when viewing static images, such as spreadsheets or similar content.

1. Login to AMS. Refer to [Accessing Decoders in AMS \(page 19\)](#), if necessary.
2. Click **HDMI OUTPUT** in the menu bar.
3. Click the **SHOW ADVANCED** button.
4. Scroll down to the **Video Optimization** section and click the **Video Optimization** drop-down list to select the desired mode.

Mode	Description
Computer Graphics	Optimizes the image when viewing static images, such as spreadsheets or similar content.
Motion Video	Provides the best viewing experience when streaming motion graphics and/or video.

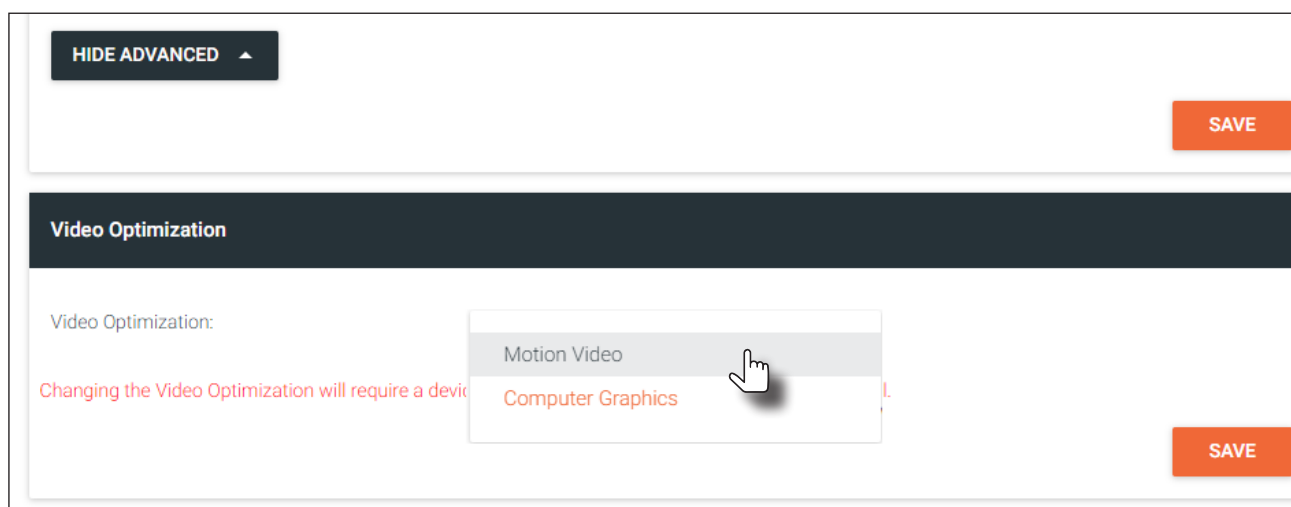

4. Click the **SAVE** button, within the **Video Optimization** section to commit changes. Note that switching between video modes may take a few moments to complete.
5. Go to the encoder interface and repeat the process. Refer to the *OmniStream Single-Channel / Dual Channel A/V Encoder User Manual*, if necessary.



NOTE: In order to use 3840x2160p60 signals, the **System mode** must be set to **Video**.

Slate / Logo Insertion



IMPORTANT: Slate / logo insertion is not supported when fast switching is enabled. Refer to [Fast Switching \(page 37\)](#) for more information on enabling and disabling fast switching.

Slate / logo insertion is managed from within AMS. The difference between a “slate” and “logo” is in the size of the image and how it is used: Logos are classified as smaller, low-resolution images that can be positioned at specified locations on the screen. Slates occupy the entire screen. Note that while logos may be used as slates, the image quality will be degraded, as the image will be scaled to fill the screen.

Slate / logo insertion can be performed on both the encoder and decoder. When configured on the encoder, the image that is displayed will be from the encoder IP address(es) to which each decoder is subscribed. When configured on the decoder, the presence of the image is specified on the (individual) HDMI output. Refer to the *OmniStream Single-Channel / Dual Channel A/V Encoder User Manual*, for information on managing slate / logo insertion on encoder units.



IMPORTANT: When using 4K images, the image width must not exceed 30% of the horizontal resolution.

1. Login to AMS. Refer to [Accessing Decoders in AMS \(page 19\)](#) if necessary.
2. Click **OTHER** in the menu bar.
3. Verify that **Logo** is selected, near the upper-left corner of the screen. **Logo** is the default selection and applies to both logo and slate images.
4. Enter the name of the image in the **Name** field. If a name is not specified, then the **UPLOAD** button will be disabled.
5. Under the **New logo** window group, click the **Choose File** button and select the image to be used. Only .png files are valid selections.
6. Click the **UPLOAD** button to upload the file.

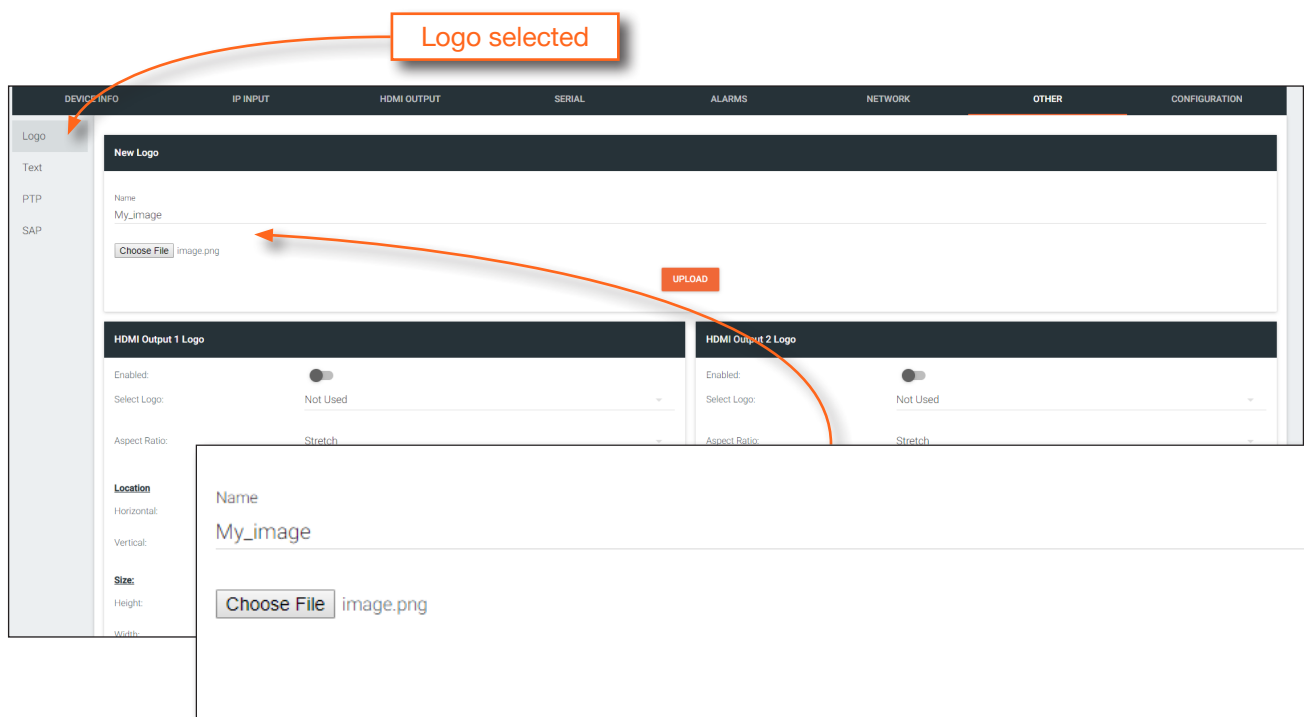

7. A new window group will be created with the name of the logo that was provided in Step 4.

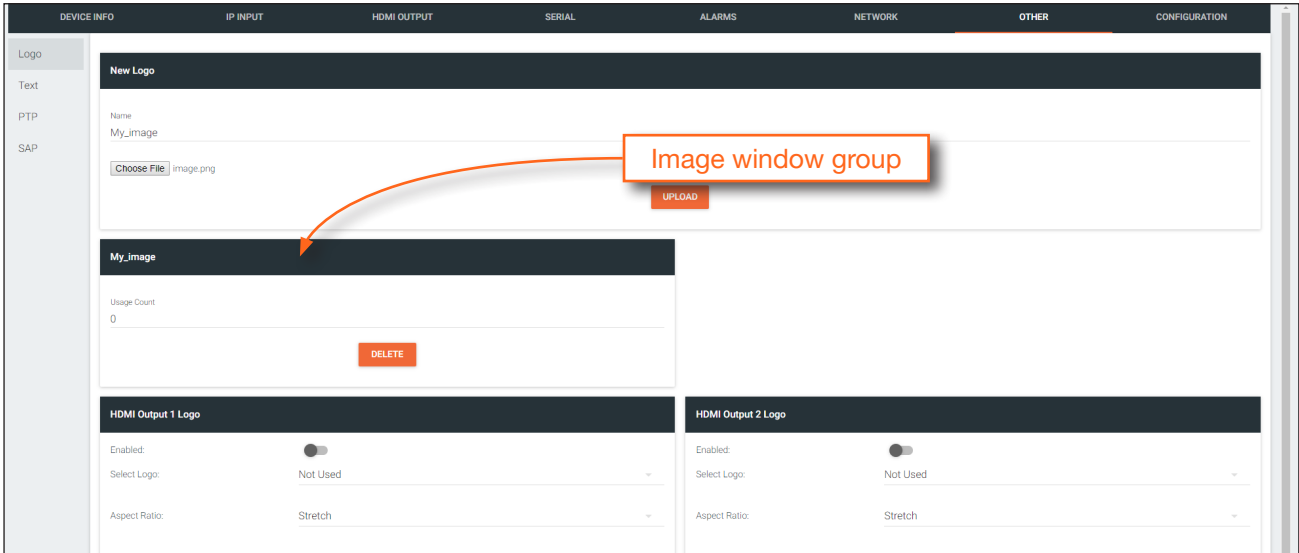

8. Perform one of the following:

- If the selected image will be used as a *logo*, then proceed with Steps 9 through 13.
- If the image will be used as a *slate*, skip to Step 14.

9. Under the **HDMI Output Logo** window group, click the **Select Logo** drop-down list and select the desired logo. To prevent the image from being displayed, select the **Not used** option.

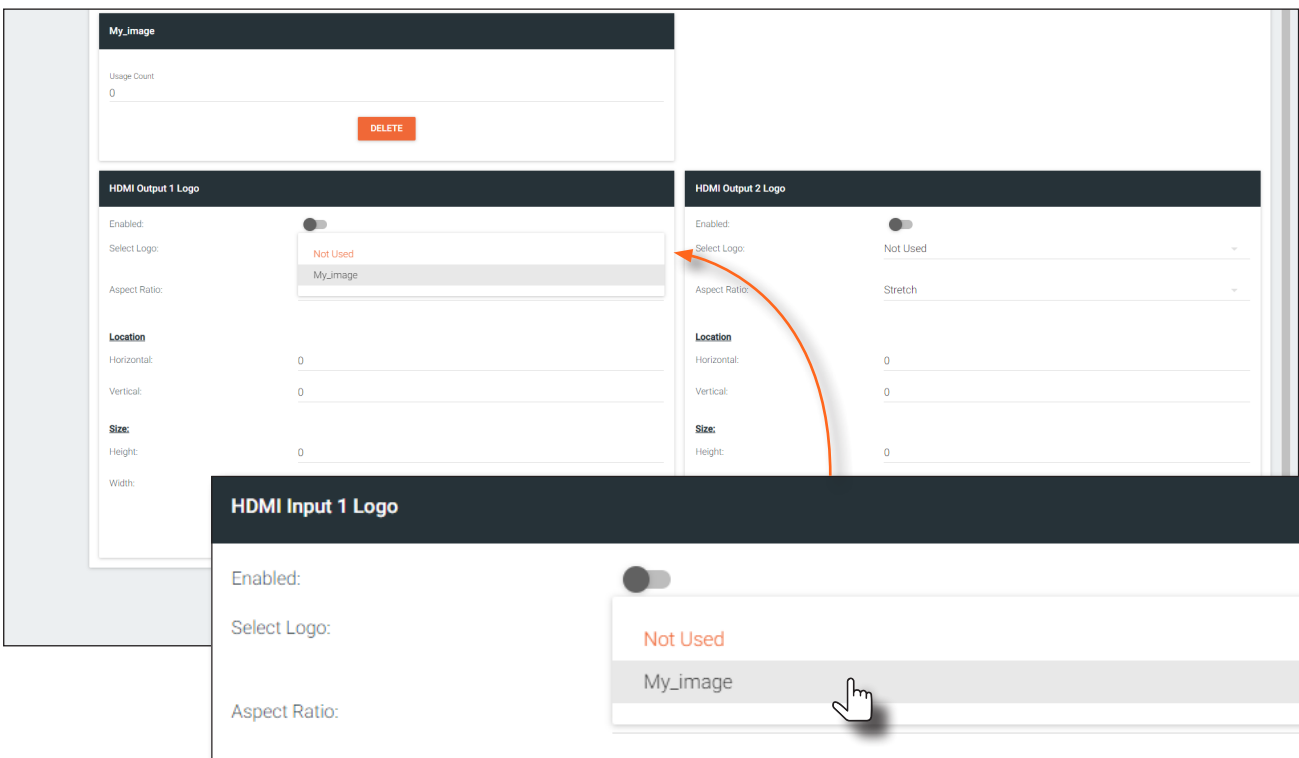

10. Click the **Aspect Ratio** drop-down list to set the aspect ratio of the image. Selecting **Keep** will maintain the aspect ratio. Select **Stretch** to scale the image to fill the screen.
11. Enter the location of the on-screen image, in pixel values, by entering the desired values in the **Horizontal** and **Vertical** fields.
12. Click the **Enabled** toggle switch to activate the logo/slate feature. When enabled, this toggle switch will be green.
13. Click the **SAVE** button to commit changes.
14. Click **HDMI OUTPUT** in the menu bar, then click the **SHOW ADVANCED** button.
15. Click the **Slate mode** drop-down list, and select **Off**, **Manual**, or **Auto**.

Mode	Description
Off	Disables the image from being displayed.
Manual	The image will always be displayed, superimposed on the source signal, and will remain even if the source signal is lost.
Auto	The image will only be displayed when the source signal is lost. For example, this mode is useful in conference room applications for displaying system instructions when no sources are connected.

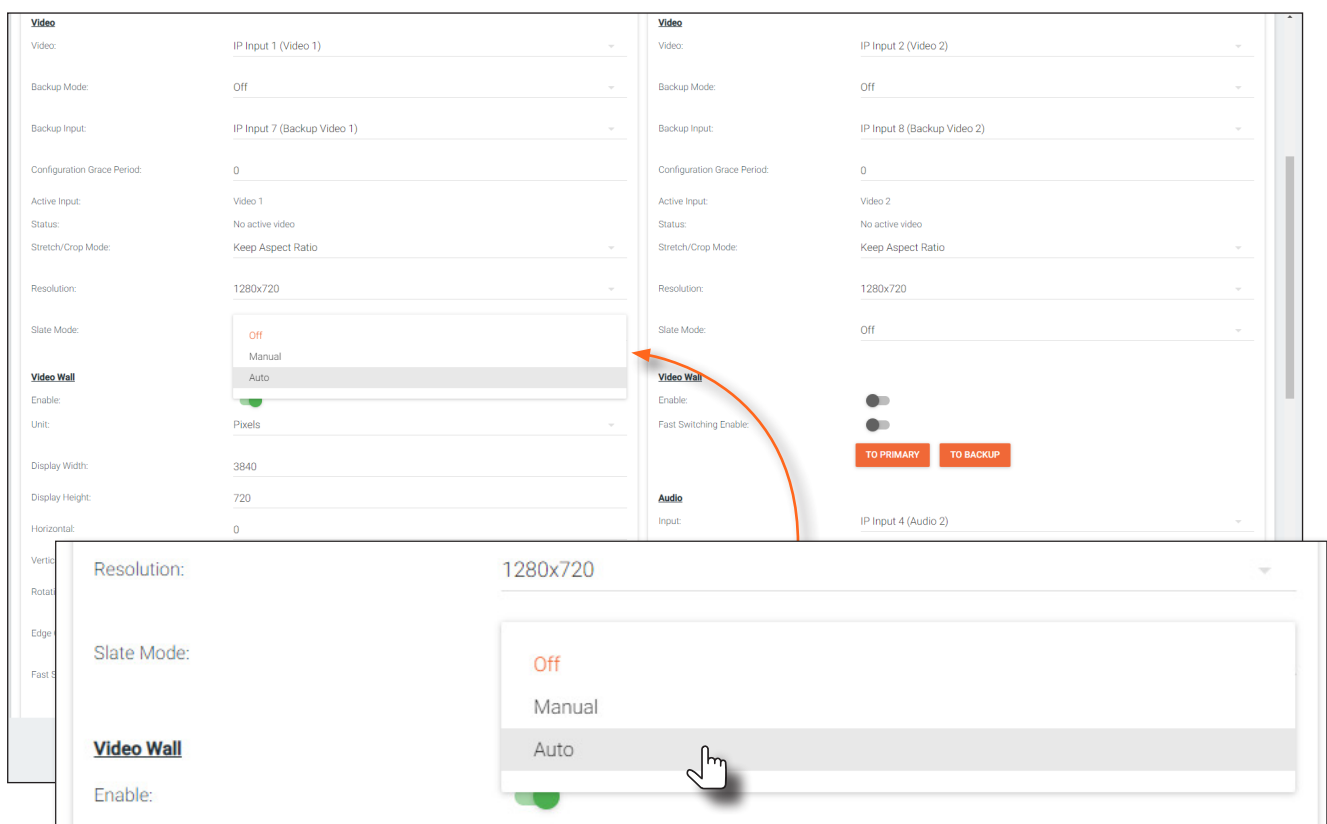

The screenshot displays the configuration interface for two video inputs. The left panel shows settings for 'Video 1' (IP Input 1) with 'Slate Mode' set to 'Off'. The right panel shows settings for 'Video 2' (IP Input 2) with 'Slate Mode' set to 'Off'. A 'Video Wall' section is visible below the video settings, and an 'Audio' section is at the bottom. A red arrow points from the 'Slate Mode' dropdown in the right panel to the 'Auto' option in the expanded menu. A hand cursor is shown clicking on the 'Auto' option.

16. Click the **Slate Logo** drop-down list and select the desired image. Note that if **Slate Mode** is set to **Off**, then this field will not be visible.
17. Click the **SAVE** button to apply all changes.

Deleting Slates / Logos

Follow the instructions below to remove a logo from the **Logo** tab.

1. Click **OTHER** tab in the menu bar.
2. Click the **DELETE** button for the desired logo box. If the **DELETE** button is disabled, do the following:
 - a. Locate the **HDMI Output Logo** window groups.
 - b. Click the **Select Logo** drop-down list and select **Not Used**.
 - c. Click the **SAVE** button.
 - d. Refresh the page.
 - e. Click the **DELETE** button to remove the logo.

Text Insertion

Text can be inserted and scrolled across the screen, making it useful for messages and notifications. Several options are available when using text: Scroll speed adjustment (forward, reverse, or static), number of iterations, text color, vertical / horizontal position, as well as transparency.

1. Login to AMS. Refer to [Accessing Decoders in AMS \(page 19\)](#) if necessary.
2. Click **OTHER** in the menu bar.
3. Click **Text** in the side menu bar, in the upper-left corner of the AMS screen.
4. Click the **Enabled** toggle switch, to allow the text to be displayed. When enabled, the toggle switch will be green.

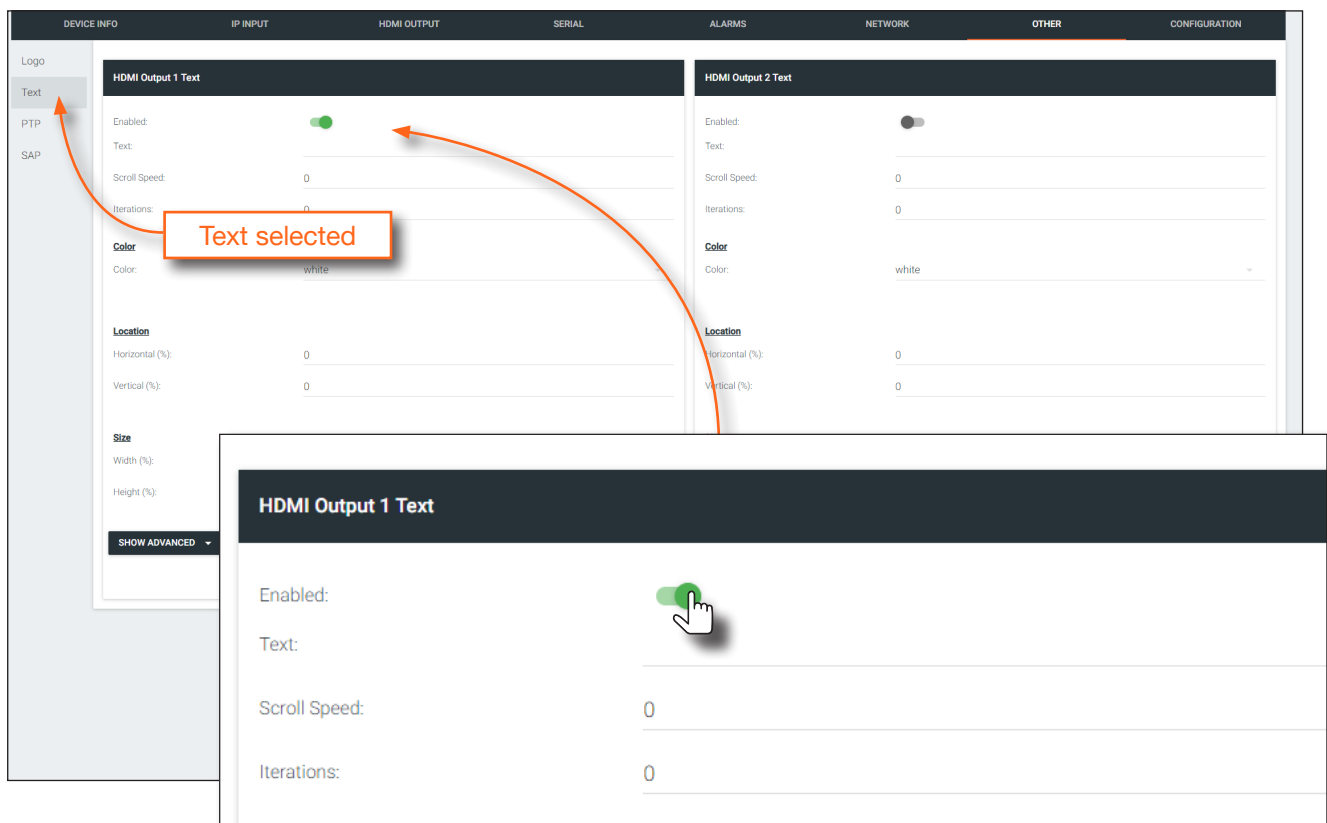

5. In the **Text** field, enter the desired text.
6. Specify the speed of the scrolling text in the **Scroll Speed** field. Values from -255 to 255 are valid. Negative numbers will scroll the text from left to right. Positive numbers will scroll text from right to left.
7. Enter the number of iterations in the **Iteration** field. Set this field to 0 (zero) to set the number of iterations to infinity.
8. Click the **Color** drop-down list to select the color of the text. The **Red**, **Green**, and **Blue** fields can be changed to further modify the color of the text. Adjust the **Alpha** field to control the transparency of the text. A value of 255 is opaque and a value of 0 is transparent. Numbers from 0 to 255 are valid for each of these fields.
9. Specify the location of the text in the **Horizontal (%)** and **Vertical (%)** fields. Each of these values is based on the horizontal and vertical resolution of the screen.

10. Specify the size of the text in the **Width (%)** and **Height (%)** fields. Each of these values is based on the horizontal and vertical resolution of the screen.
11. Click the **SAVE** button to apply all changes.

Fast Switching



IMPORTANT: If Fast Switching is enabled, latency increases from 0.5 frames to 1.5 frames. When using Fast Switching mode, the output resolution will be 1920x1080p, regardless of the source resolution. Also note that 1080i is not supported in Fast Switching mode. Also note that Slate / Logo Insertion and Text Insertion will be automatically disabled when Fast Switching is enabled.

This feature is a software implementation which vastly improves the HDMI authentication process, resulting in ultra-fast switching between video streams.

1. Login to AMS. Refer to [Accessing Decoders in AMS \(page 19\)](#) if necessary.
2. Click **HDMI OUTPUT** in the menu bar.
3. Click the **Fast Switching Enable** toggle switch. By default, this feature is disabled and the toggle switch will be gray. Click the toggle switch to enable fast switching. When enabled, the toggle switch will be green.

Video	
Video:	IP Input 1 (Video 1)
Input Status:	No active video
Active Input:	Video 1
Output Status:	No active video
HDR:	<input type="radio"/>
Stretch/Crop Mode:	Keep Aspect Ratio
Resolution:	Input
Framerate:	Auto
Fast Switching Enable:	<input checked="" type="checkbox"/>
Fast Switching Timeout (s)	5

4. Enter the timeout interval in the **Fast Switching Timeout (s)** field. When fast switching is enabled, and if the decoder is switched to a different stream, but the stream is not present, then the decoder will hold the last image on the screen, until either a new stream appears or the decoder is switched to a different stream. Once the timeout interval has expired, the screen will go black. Setting the timeout interval to 0 disables this feature and the last image will be displayed indefinitely. The timeout interval is in seconds.
5. Set the output resolution and frame rate in the **Resolution** and **Framerate** fields. The following table provides maximum timing, color space, and bit-depth specifications when fast switching is enabled.

Number of Channels	Resolution	Framerate	Color Space	Bit Depth
1	1920 x 1200	60 Hz	4:4:4	12-bit
2	1920 x 1200	30 Hz	4:4:4	12-bit



NOTE: When fast-switching is enabled, the output resolution at the decoder endpoint is dependent on both the number of channels on the decoder and the input resolution received from the encoder. Refer to the table below for details.

Input Resolution (from Encoder)	Output Resolution (AT-OMNI-121)	Output Resolution (AT-OMNI-122)
1280 x 720p	1280 x 720p	1280 x 720p
1920 x 1080p @ 60 Hz	1920 x 1080p @ 60 Hz	1920 x 1080p @ 30 Hz
> 1920 x 1080p (up to UHD)	1920 x 1080p @ 60 Hz	1920 x 1080p @ 30 Hz

IR Control

Controlling the Display using the Display's IR Remote

The same port that provides RS-232 connections also supports bidirectional IR pass-through, allowing a device to be controlled from either the headend or the decoder endpoint. This step is optional. IR control is only supported on **RS-232 2** port (bottom set of connectors).

The following sections provide step-by-step instructions for the following topics:

- Controlling the Display using the Display's IR Remote
- Controlling the Display using a Control System

The illustration below shows a display device being controlled from the encoder. Refer to the next page for details on how to connect the IR emitter and IR receiver.

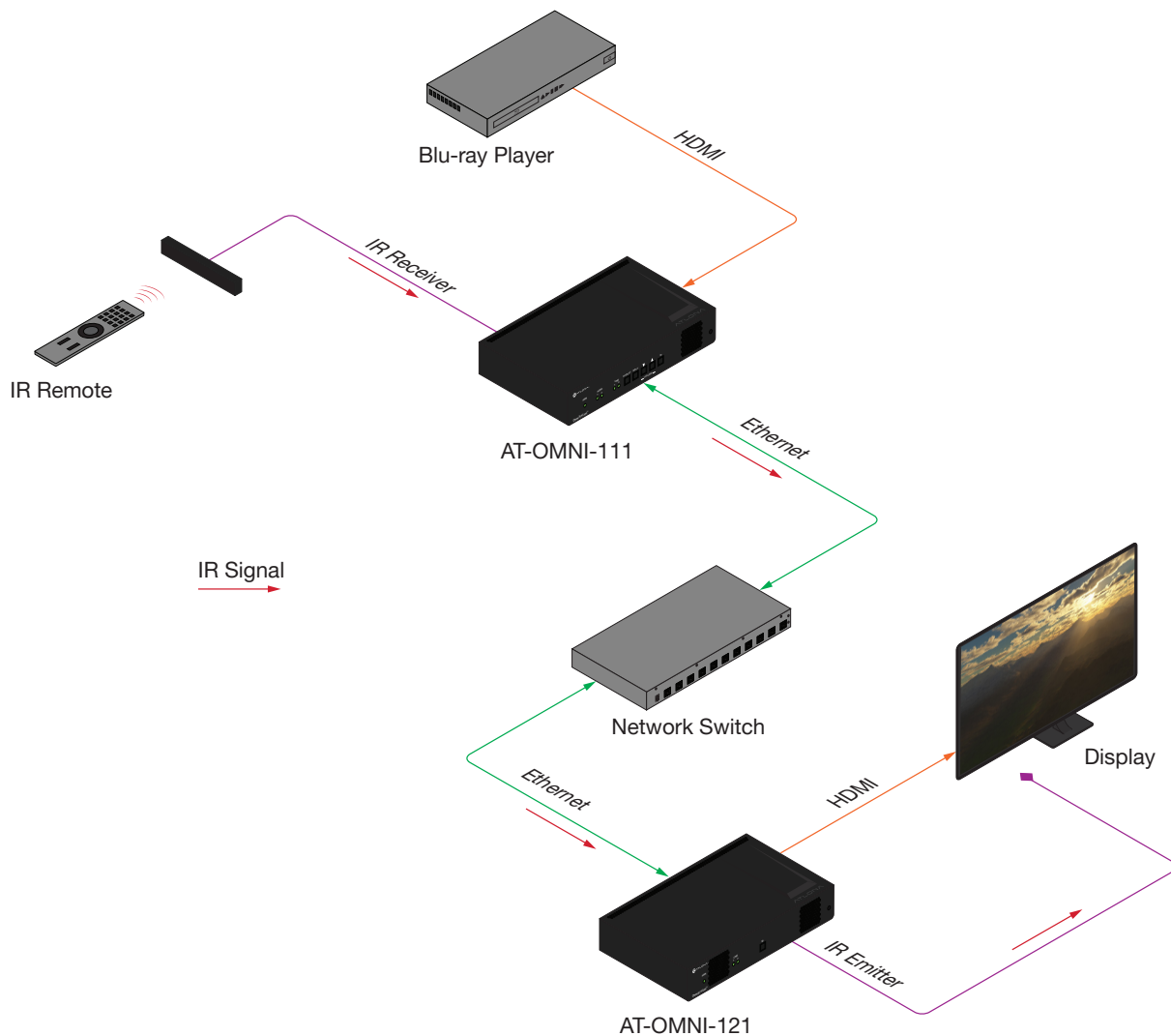

Required Equipment

Atlona has tested and verified the following components for this application. However, other components may also be used. Note that IR control is only supported on **RS-232 2** port (bottom set of connectors) of the OmniStream encoder and decoder.

- Xantech 789-44 4-Source Connecting Block
- Xantech 12 V PSU
- IR Receiver (Atlona AT-IR-CS-RX)
- IR Emitter (Atlona AT-OMNI-IR-TX)

Connecting the IR Receiver to the Encoder

1. Unscrew the captive screw connectors on the Xantech 789-44 4-Source Connecting Block, using a regular screwdriver, and connect the SIGNAL, GROUND, and POWER leads of the AT-IR-CS-RX to the Xantech 789-44 4-Source Connecting Block, as shown below. The presence or absence of white markings on each wire of the AT-IR-CS-RX will denote the signal type:

IR IN	= Dashed dark gray line
GND	= Solid (no marking) black wire
+12 VDC	= solid dark gray line



IMPORTANT: When connecting the IR emitter to the encoder, the IR lens of the emitter must be within 1" of the IR window on the source device.

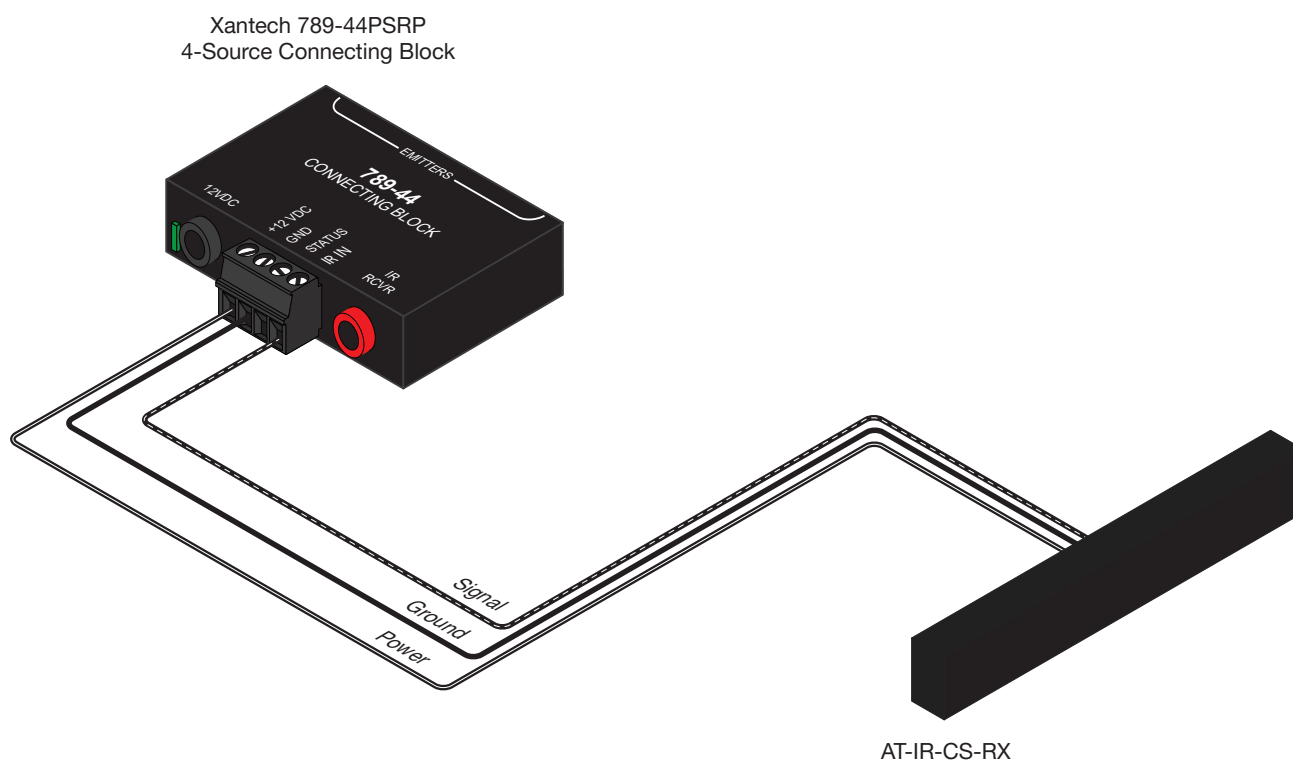

2. Connect the IR IN and GND leads, from the 789-44 4-Source Connecting Block, to the **RX** and \perp pins, respectively, of the **RS-232 2** port (bottom port) of the encoder, as shown.



NOTE: The IR IN, GND, and +12 VDC wires, from Step 1, have been removed from the illustration below, for purposes of clarity.

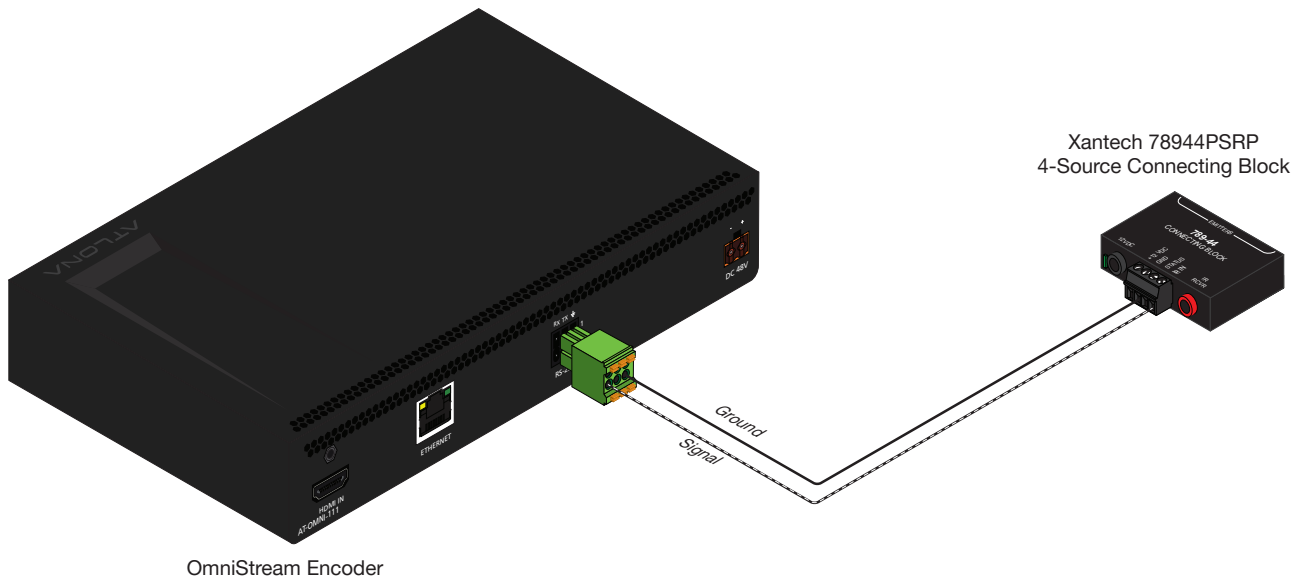

3. Connect the Xantech 12 V power supply (or other compatible 12 V DC power supply) to the 12VDC connector on the Xantech 789-44 4-Source Connecting Block.

Connecting the IR Emitter to the Decoder

1. Connect the included 6-pin Euroblock push-spring connector to the **RS-232 2** port on the encoder.
2. Connect the SIGNAL wire of the AT-OMNI-IR-TX, to the **TX** (middle) terminal on the **RS-232 2** port.
3. Connect the GROUND wire of the AT-OMNI-IR-TX to the \perp terminal on the **RS-232 2** port.

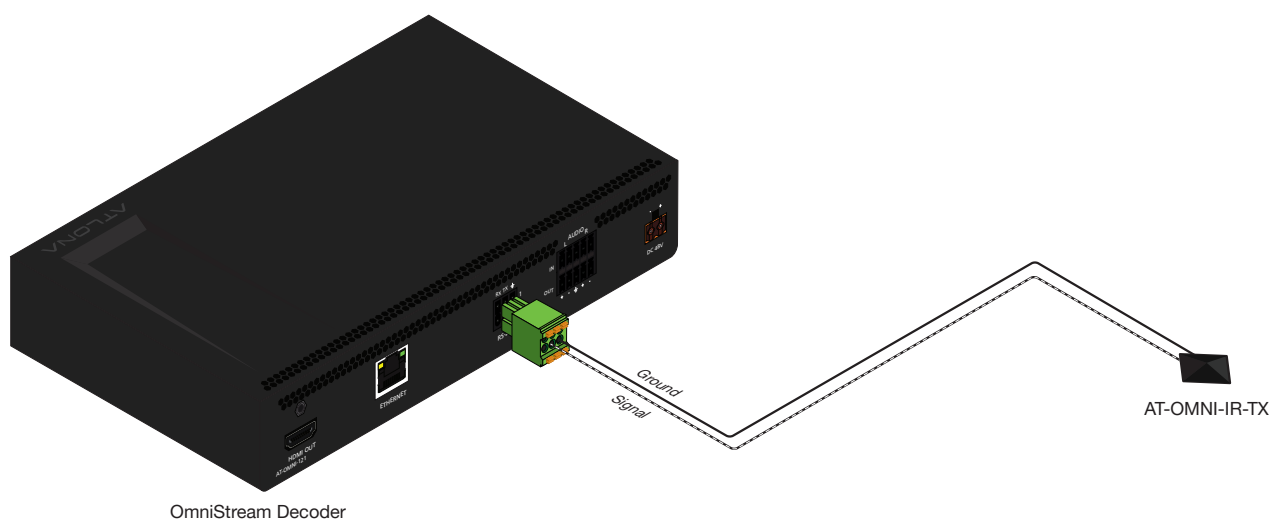

Identifying the Encoder using AMS

1. Launch a web browser and enter the IP address of AMS in the address bar.
2. Enter the required login credentials. The default login is:

Username: admin
Password: Atlona
3. Click the **Login** button.
4. The AMS Dashboard will be displayed.
5. Click the ☰ icon, in the upper-left corner of the AMS Dashboard.

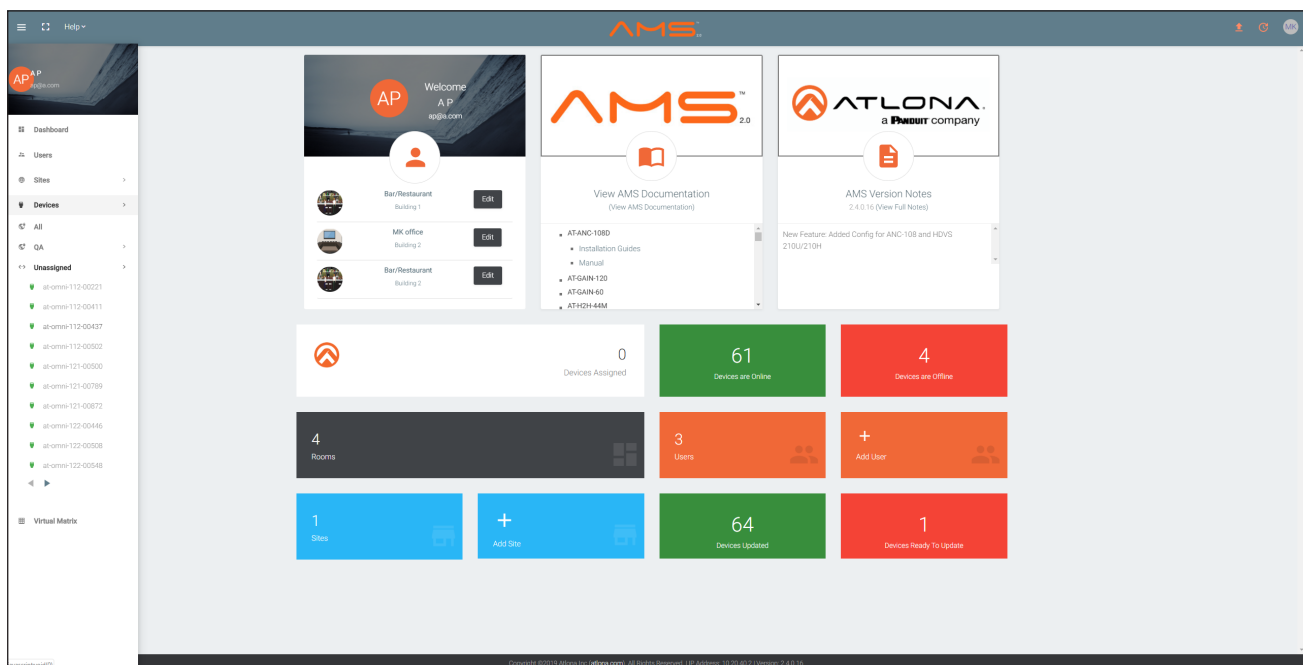

6. Click **Devices** from the fly-out menu.
7. Click the **All** option.
8. Click the desired encoder within the **AMS Device List** window. The AMS interface for the encoder will be displayed.
9. Locate and make note of the IP address of the encoder, which can be found in the **IP Address** field.



Configuring the Encoder Serial Port

The first step will be to configure the RS-232 port on the encoder to use IR. Only the **RS-232 2** port supports both RS-232 and IR. Therefore, this port must be used for IR. RS-232 port configuration is managed under the Serial page of the encoder web interface.

1. Enter the IP address of the encoder in the address bar of the web browser.
2. Enter the required login credentials. The default login is:

Username: admin

Password: Atlona

3. Click the **Login** button.
4. Click **Serial** in the top menu bar.

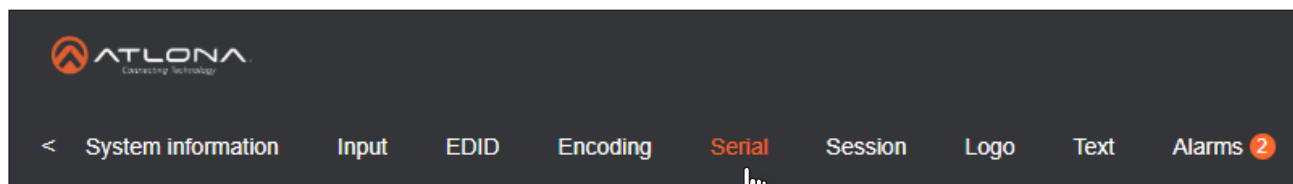

5. Locate the **Serial port configuration** window group. The **Name** field, within this window group, should read **serial_port2**. Click the **Mode** drop-down list and select **Infrared**.
6. Click the **SAVE** button to commit changes.

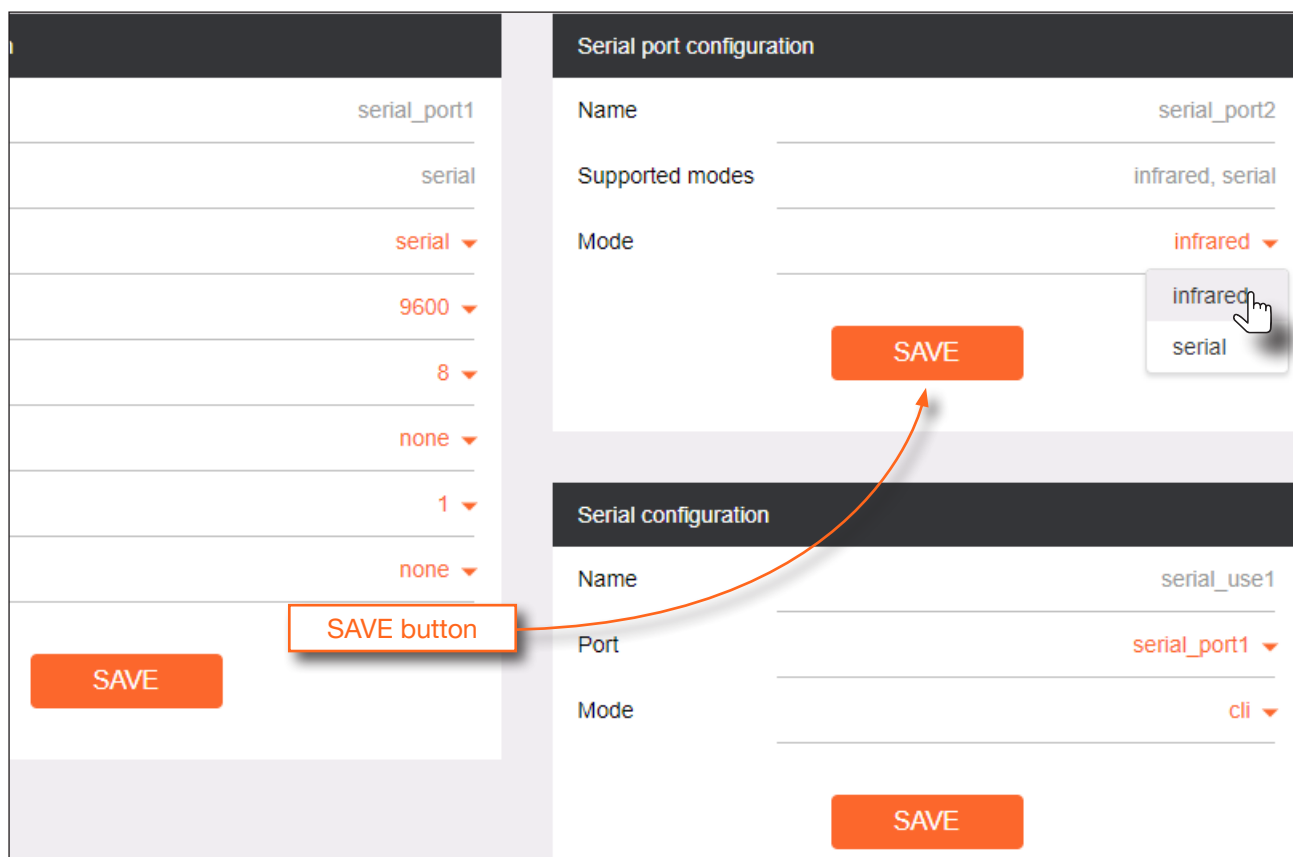

Configuring the Encoder Session

The next step is to assign the IR control for Serial Port 2 to the desired Session.

1. Click **SESSION** in the top menu bar.

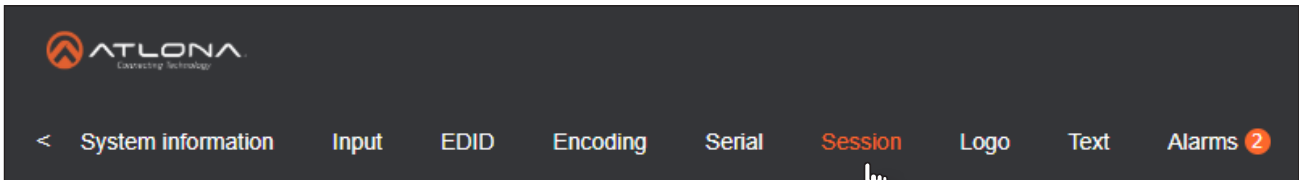

2. Locate the **Session 1** window group.



NOTE: **Session 2** can also be used with IR. However, in this example, **Session 1** will be configured.

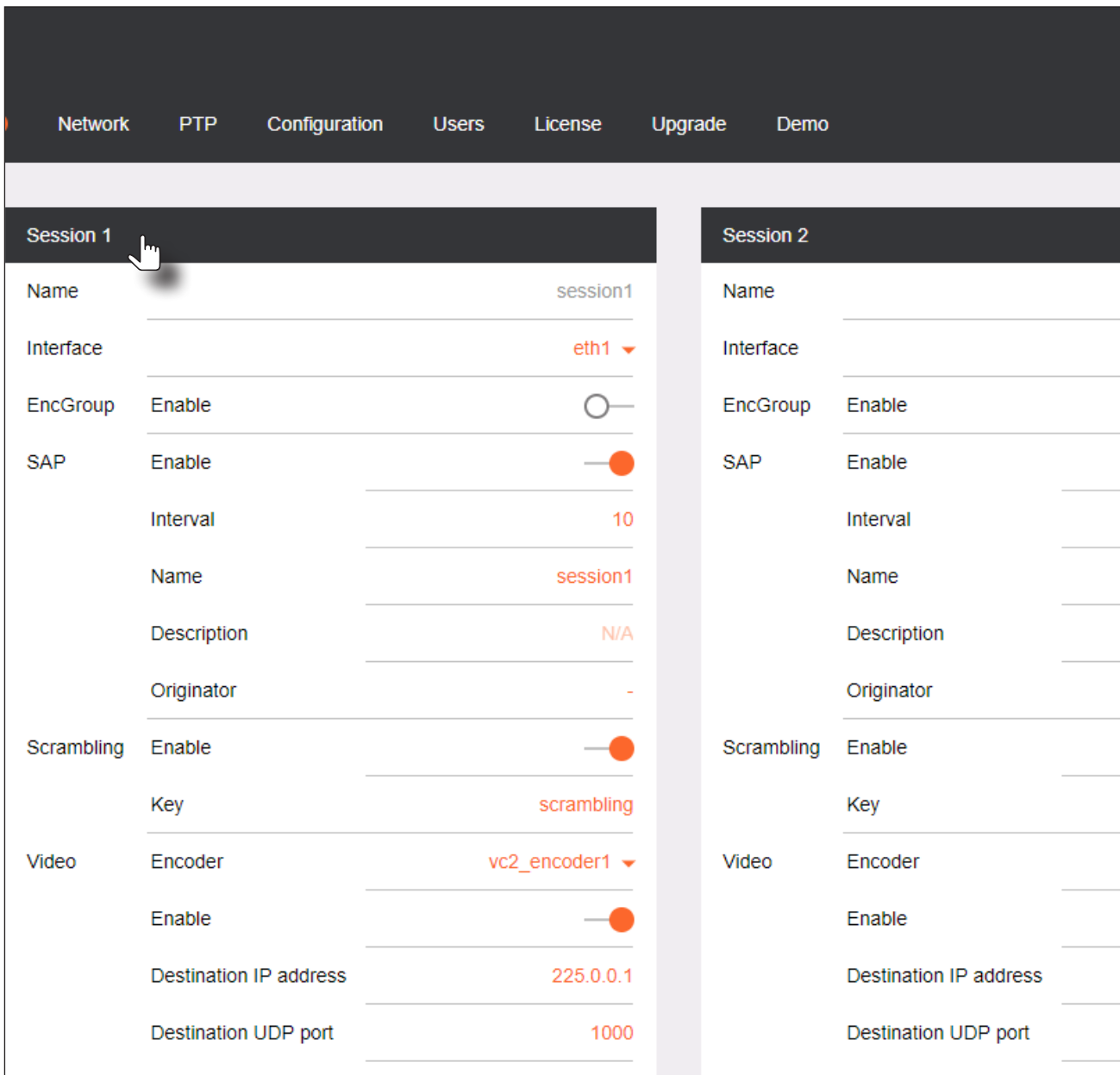

 A screenshot of the configuration page for sessions. The top navigation bar includes: Network, PTP, Configuration, Users, License, Upgrade, and Demo. Below this, there are two panels for Session 1 and Session 2.

Session 1		Session 2	
Name	session1	Name	
Interface	eth1	Interface	
EncGroup	Enable <input type="checkbox"/>	EncGroup	Enable
SAP	Enable <input checked="" type="checkbox"/>	SAP	Enable
Interval	10	Interval	
Name	session1	Name	
Description	N/A	Description	
Originator	-	Originator	
Scrambling	Enable <input checked="" type="checkbox"/>	Scrambling	Enable
Key	scrambling	Key	
Video	Encoder	Video	Encoder
Enable	<input checked="" type="checkbox"/>	Enable	
Destination IP address	225.0.0.1	Destination IP address	
Destination UDP port	1000	Destination UDP port	

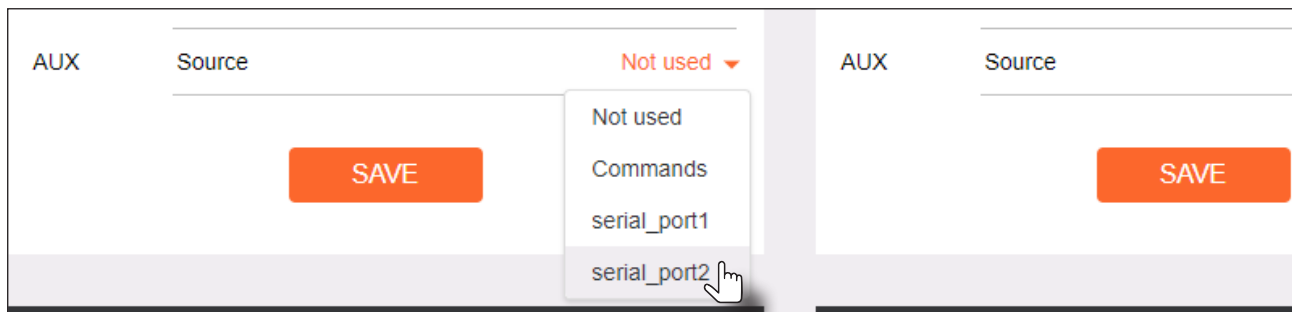
3. Scroll down and locate the **AUX** section.
4. Click the **Source** drop-down list and select **serial_port2**.

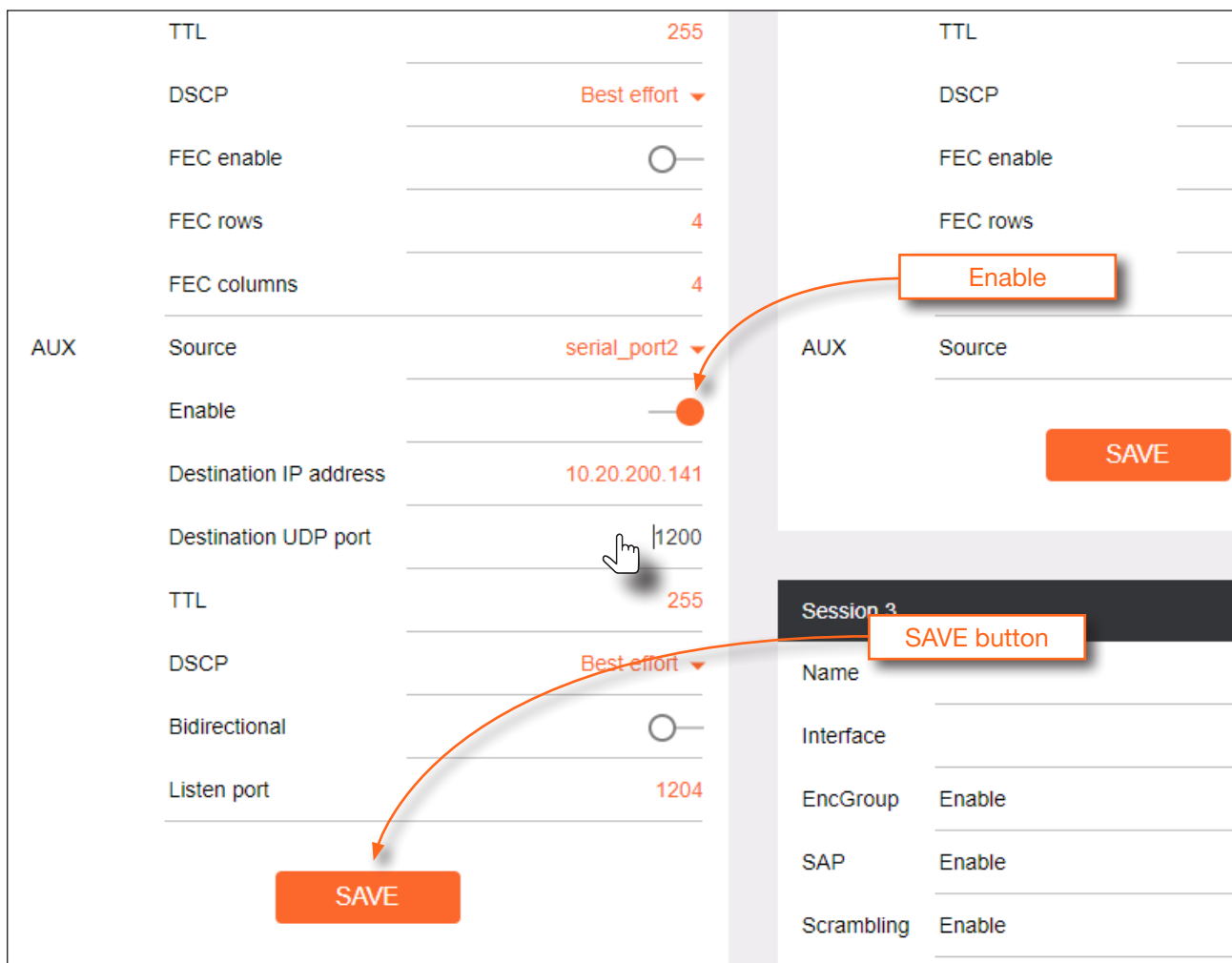

5. Enable the auxiliary (AUX) channel by clicking the **Enable** toggle switch. When the auxiliary channel is enabled, this toggle switch will be orange.
6. Enter the IP address of the *decoder* in the **Destination IP Address** field. This is the decoder to which the IR emitter is connected. In this example, the decoder IP address is 10.20.200.141.
7. Enter the port number in the **Destination UDP Port** field.
8. Click the **SAVE** button to commit changes.



Configuring the Decoder Serial Port

1. Select the desired decoder within the **AMS Device List** window and make note of the decoder IP address.
2. Enter the required login credentials. The default login is:

Username: admin
 Password: Atlona

3. Click the **Login** button, then click **IP Input** in the top menu bar.

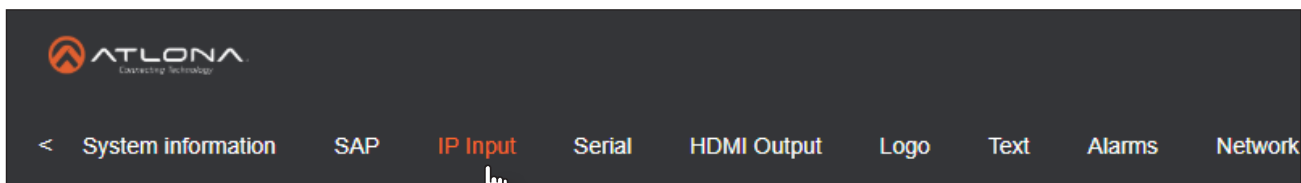

4. Scroll down to the **Input 5** window group.
5. Enable **Input 5** by clicking the **Enable** toggle switch. When enabled, this toggle switch will be orange.



NOTE: **Input 5** is dedicated to IR. Therefore, this input *must* be used in order for end-to-end IR to function properly.

6. Enter the port in the **Port** field. This port number must be the same port used by the encoder, and is the input of the decoder that will receive IR data.



IMPORTANT: Do not change the contents of the **Multicast Address** field. Unicast mode uses the IP address of the decoder for communication. Therefore, only the port number is required.

7. Click the **SAVE** button to commit changes.

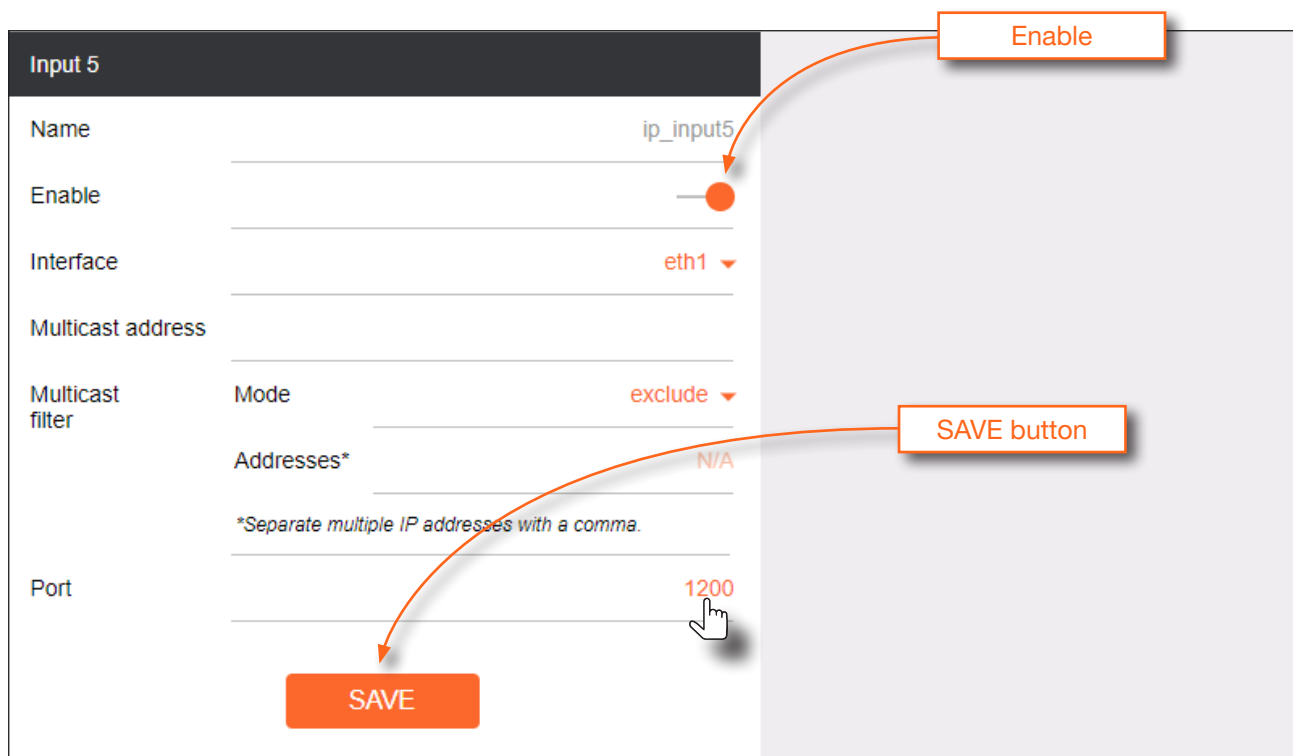

8. Click **Serial** in the top menu bar.

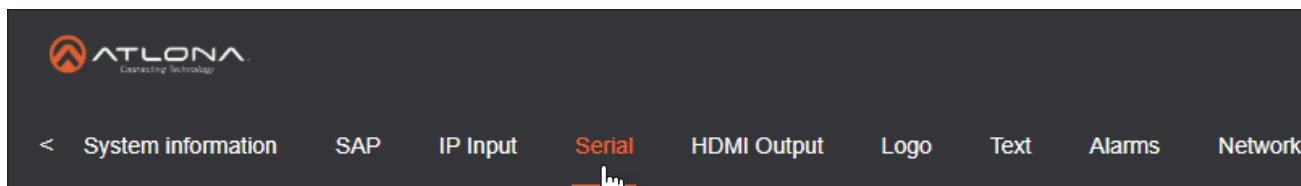

9. Locate the **Serial port configuration** window group. The **Name** field, within this group, should read **serial_port2**. Click the **Modes** drop-down list and select **Infrared**.

10. Click the **SAVE** button to commit changes.

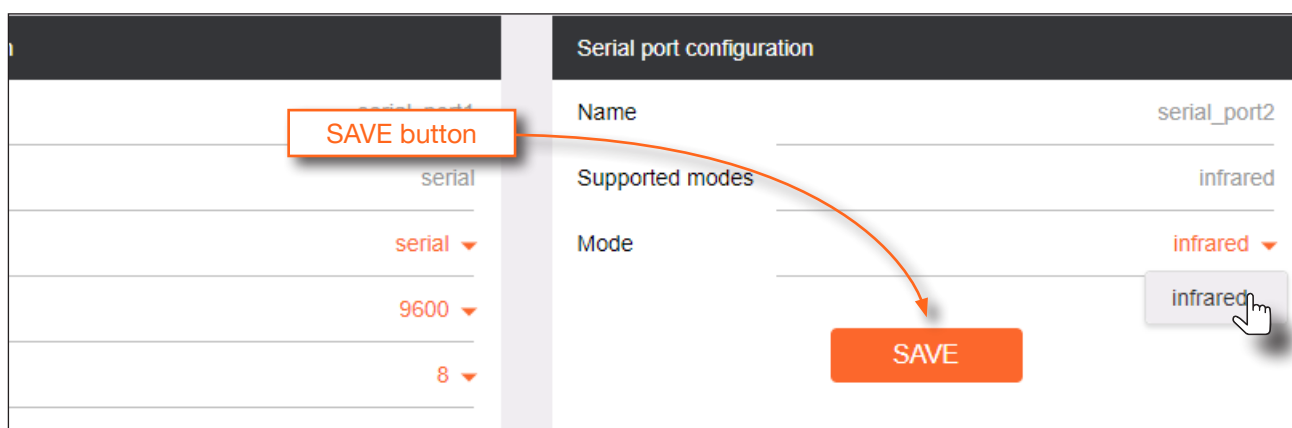

11. Scroll down the page and locate the **Serial Configuration** window group. The **Name** field, within this group, should read **serial_use2**.

12. Click the **Port** drop-down list and select **serial_port2**.

13. Click the **Mode** drop-down list and select **output**.

14. Click the **Input** drop-down list and select **ip_input5**.

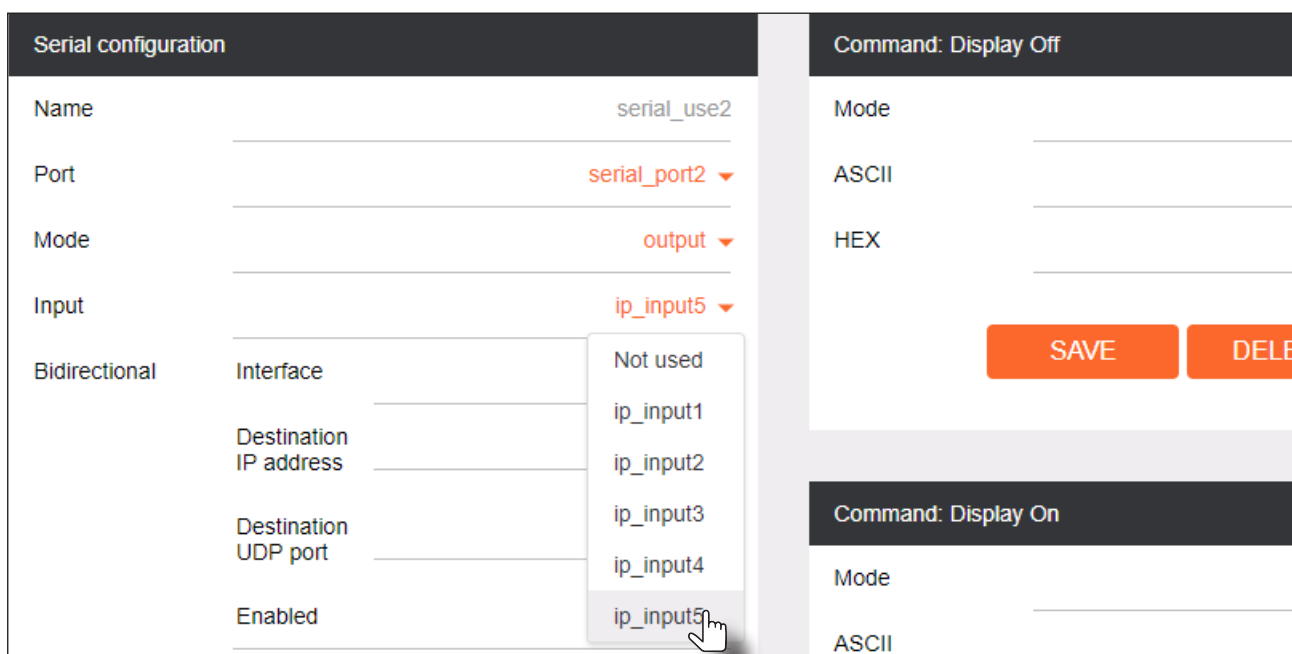

15. Click the **SAVE** button to commit changes.

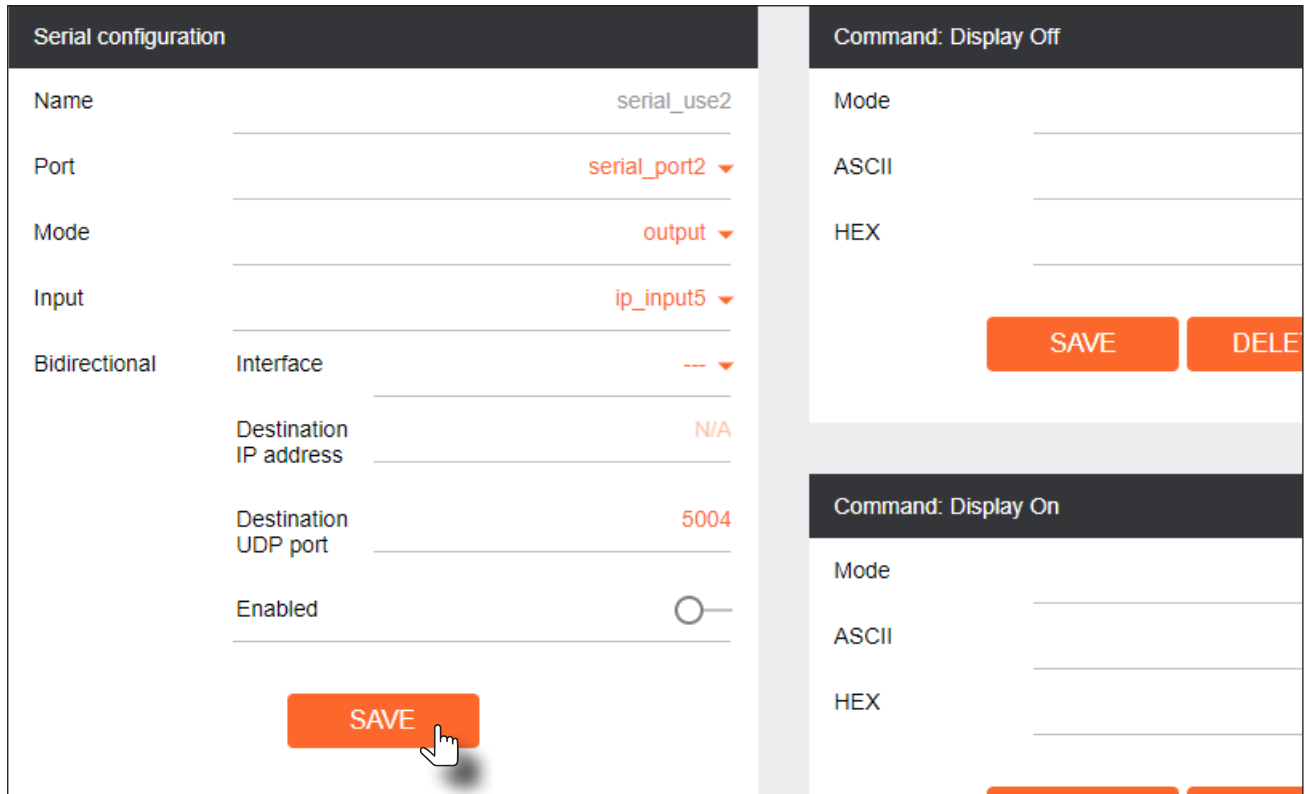

The screenshot displays a configuration interface for the AT-OMNI-121 / AT-OMNI-122 device. It is divided into two main sections: 'Serial configuration' on the left and 'Command' settings on the right.

Serial configuration section:

- Name:** serial_use2
- Port:** serial_port2 (dropdown menu)
- Mode:** output (dropdown menu)
- Input:** ip_input5 (dropdown menu)
- Bidirectional:** A sub-section containing:
 - Interface:** --- (dropdown menu)
 - Destination IP address:** N/A
 - Destination UDP port:** 5004
 - Enabled:** A toggle switch currently in the 'Off' position.

At the bottom of the 'Serial configuration' section is an orange **SAVE** button with a mouse cursor hovering over it.

Command section:

- Command: Display Off** (Header)
- Mode:** (input field)
- ASCII:** (input field)
- HEX:** (input field)
- Buttons: **SAVE** and **DELETE** (partially visible)

Below this is another **Command: Display On** section with similar input fields for Mode, ASCII, and HEX, and partially visible buttons at the bottom.

Testing IR Functionality

1. Point IR remote to at the IR Receiver, as shown in the diagram below.
2. The IR remote will now sent IR data to the decoder where it will be relayed to the display device.

 **IMPORTANT:** The IR lens of the emitter must be within 1 inch (2.54 centimeters) of the IR window on the display device. If this distance is exceeded, then IR functionality may fail.

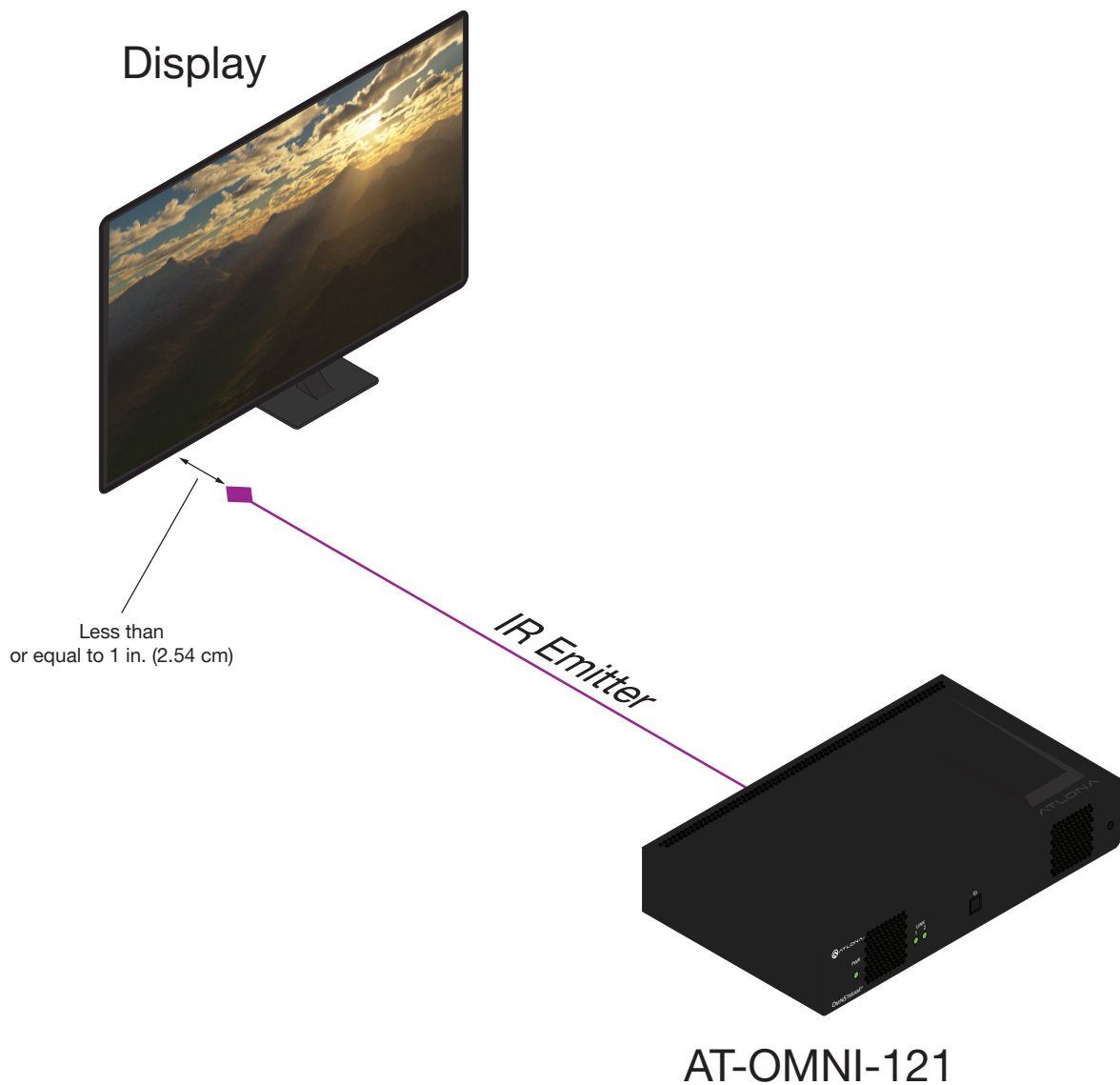

Controlling the Display using a Control System

The following steps are similar to [Controlling the Display using the Display's IR Remote](#) (page 39), except that the control system wiring should be used, instead of an IR receiver, as shown below.

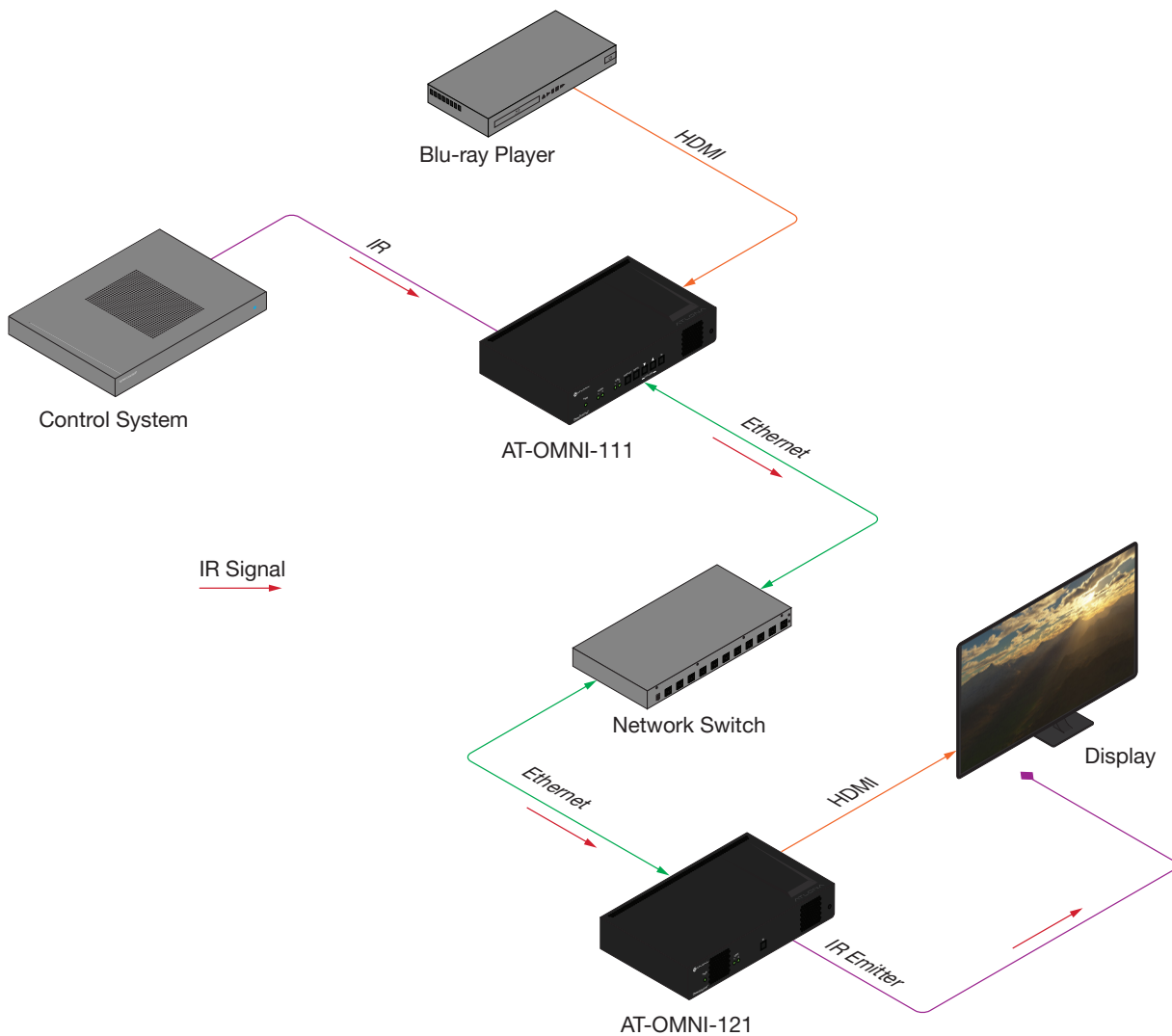

Using the Virtual Matrix

1. Login to AMS. Refer to **Accessing Decoders in AMS** (page 19) if necessary.
2. Click the  icon, in the upper-left corner of the AMS Dashboard.
3. Click on **Virtual Matrix**.

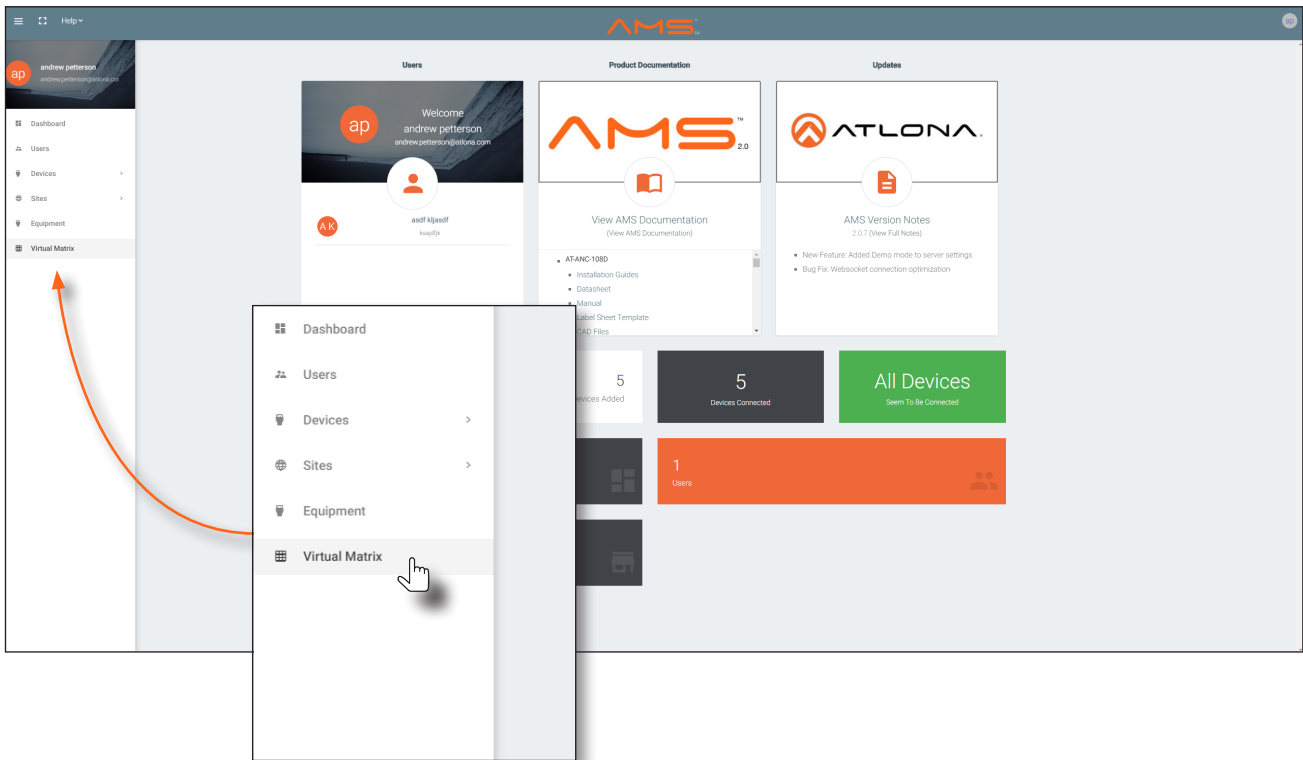

4. The **OmniStream Virtual Matrix** page will be displayed.



The screenshot displays the 'OmniStream Virtual Matrix' page. It features a table with columns for various AT-OMNI decoders and rows for different sites. Each cell in the grid contains a status icon (green checkmark, blue checkmark, or red X) indicating the connection status of the decoder at that site. A legend at the top left identifies the decoder models and their connection status.

Encoders / Decoders	AT-OMNI-122 192.168.11.181	AT-OMNI-121 192.168.11.184	AT-OMNI-122 192.168.11.86 192.168.11.87	AT-OMNI-121 192.168.11.39	AT-OMNI-122 192.168.11.160 192.168.11.161	AT-OMNI-121 192.168.11.165
AT-OMNI-112 192.168.11.89	HEM1 1 [Status Icon]	HEM1 1 [Status Icon]	HEM1 1 [Status Icon]	HEM1 1 [Status Icon]	HEM1 1 [Status Icon]	HEM1 1 [Status Icon]
AT-OMNI-111 192.168.11.50	HEM1 1 [Status Icon]	HEM1 1 [Status Icon]	HEM1 1 [Status Icon]	HEM1 1 [Status Icon]	HEM1 1 [Status Icon]	HEM1 1 [Status Icon]
AT-OMNI-112 192.168.11.51	HEM1 1 [Status Icon]	HEM1 1 [Status Icon]	HEM1 1 [Status Icon]	HEM1 1 [Status Icon]	HEM1 1 [Status Icon]	HEM1 1 [Status Icon]
AT-OMNI-112 192.168.11.115	HEM1 1 [Status Icon]	HEM1 1 [Status Icon]	HEM1 1 [Status Icon]	HEM1 1 [Status Icon]	HEM1 1 [Status Icon]	HEM1 1 [Status Icon]
AT-OMNI-112 192.168.11.183 192.168.11.148	HEM1 1 [Status Icon]	HEM1 1 [Status Icon]	HEM1 1 [Status Icon]	HEM1 1 [Status Icon]	HEM1 1 [Status Icon]	HEM1 1 [Status Icon]
AT-OMNI-111 192.168.11.167	HEM1 1 [Status Icon]	HEM1 1 [Status Icon]	HEM1 1 [Status Icon]	HEM1 1 [Status Icon]	HEM1 1 [Status Icon]	HEM1 1 [Status Icon]

5. Click on the **View** drop-down list and select **Control**.

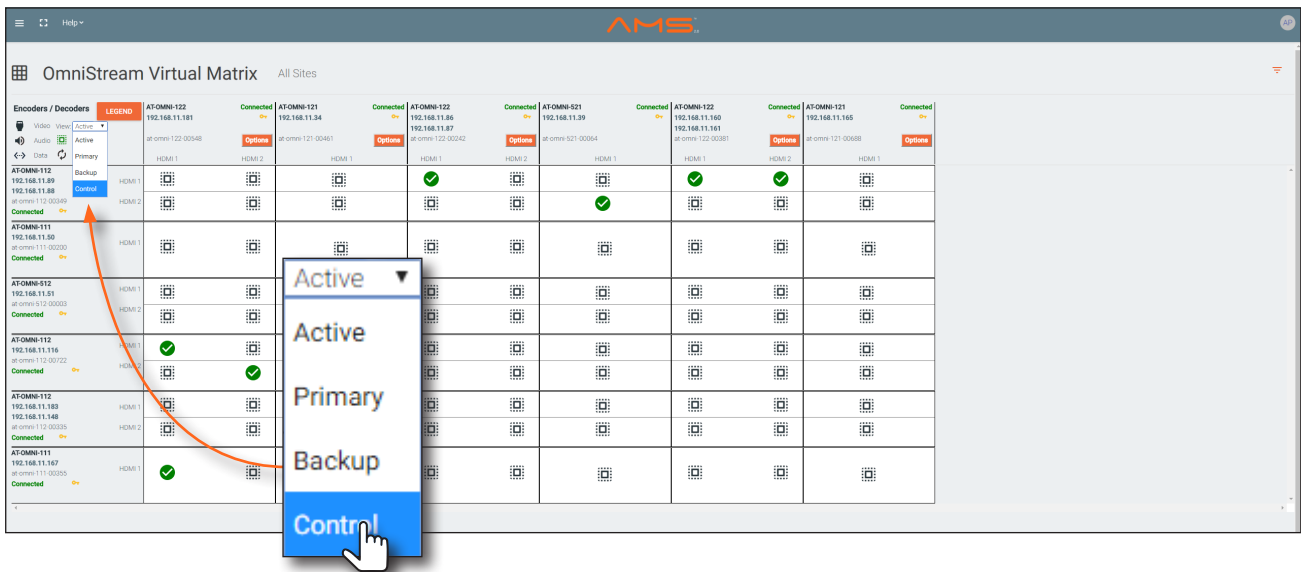

6. The Control screen will be displayed. In the Control screen, **HDMI** ports are replaced with control ports: **Port 1 In / Port 1 In** for encoders and **Port 1 Out / Port 2 Out** for decoders.

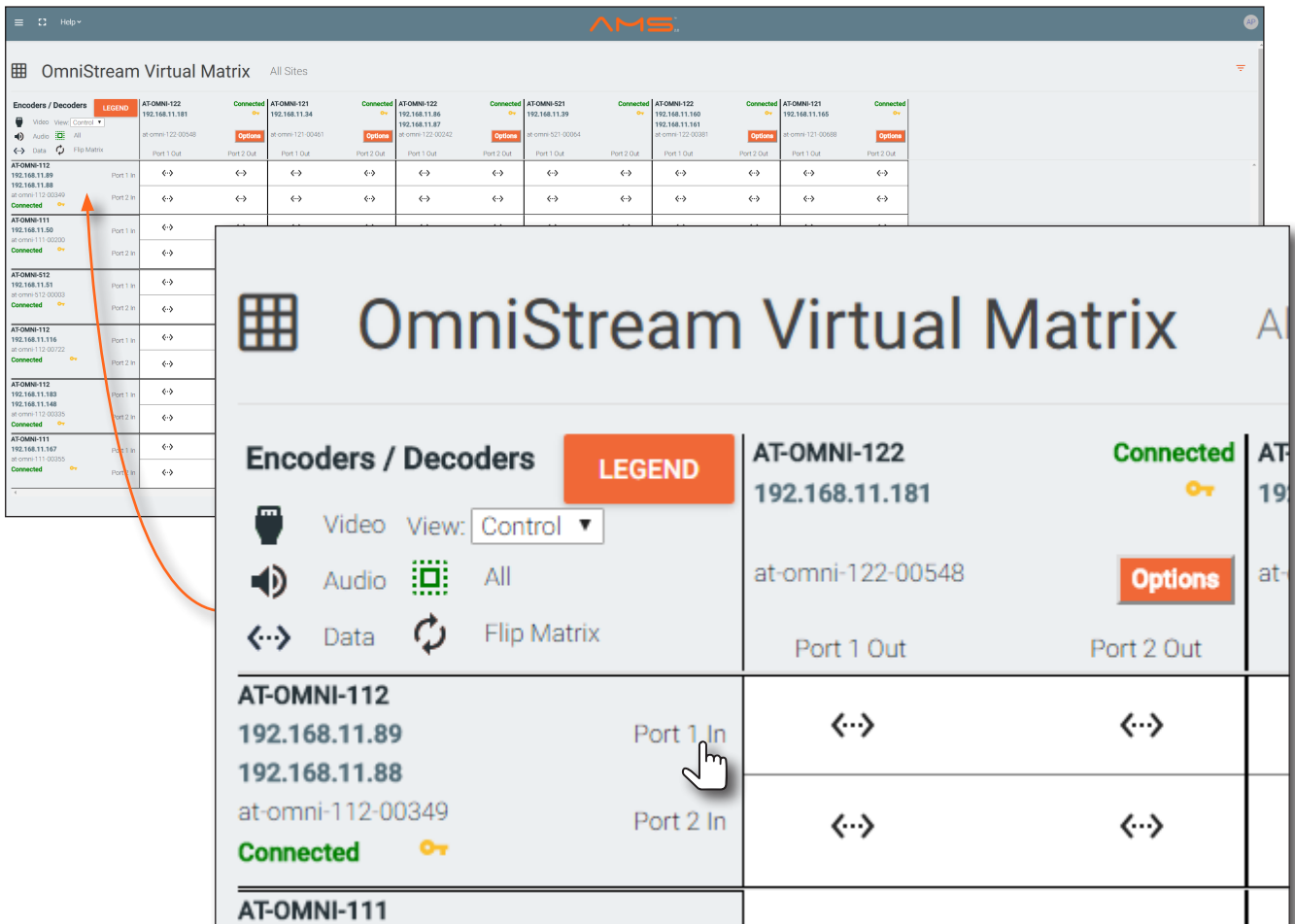

7. Click the **Options** button next to the desired decoder.

8. The **Crosspoint Options** dialog will be displayed.

Crosspoint Options: AT-OMNI-121 - 192.168.11.34

<p>Serial Port 1:</p> <p>Serial Mode - Port 1 ▾</p>	<p>Serial Port 2:</p> <div style="border: 1px solid gray; padding: 5px; margin-bottom: 5px;">Not Used</div> <div style="border: 1px solid gray; padding: 5px; background-color: #f0f0f0; margin-bottom: 5px;">IR Passthrough</div>	<p>Modes:</p> <p>RS232 Passthrough - Control System passes RS232 from Encoder input port through the Decoder output port</p> <p>IR Passthrough - Control System passes IR from Encoder input port through the Decoder output port</p> <p>Serial over IP Proxy - Mode that sends IP commands to the Decoder that are converted to RS232 commands</p> <p>RS232 Trigger - Mode that allows sending stored RS232 commands through the Decoder output port</p> <p>*CEC Trigger* Triggering CEC does not require any additional configuration. Control system may use "TrigCECX on" command</p>
<p>ADVANCED CLOSE SAVE</p>		

9. Click the **Serial Port 2** drop-down list and select **IR Passthrough**.



NOTE: Only Serial Port 2 supports IR pass-through. The IR emitter or IR receiver must be connected to this port. Refer to [IR Connections \(page 14\)](#) for wiring information.

10. Click **SAVE** to commit changes, then click **CLOSE** to dismiss the dialog and return to the Virtual Matrix page. To return to the Virtual Matrix page without saving changes, click the **CLOSE** button to dismiss the dialog.

Advanced Operation

Configuring Audio Output

! IMPORTANT: When using analog audio inputs on the OmniStream decoder, the decoder must be powered using the 48V power supply (AT-PS-48083-C). This power supply is sold separately and can be purchased from Atlona.

In addition to passing audio directly from the encoder to the decoder, both the AT-OMNI-121 and AT-OMNI-122 provide two additional audio options

- HDMI audio can be de-embedded and output to two-channel analog audio.
- Two-channel analog audio can be embedded and output over HDMI.

This section covers both methods. If using a single-channel decoder, only a single **AUDIO IN** and **AUDIO OUT** port will be available.

De-embedding Audio

De-embedding audio will extract the HDMI audio and automatically downmix to two-channel analog audio, using the included captive-screw connectors.

1. Connect the power supply to the DC 48V connector on the decoder.
2. Connect the included 5-pin captive screw connectors to the **AUDIO OUT** ports. Refer to [Audio Connectors \(page 15\)](#) for wiring information.
3. Login to AMS. Refer to [Accessing Decoders in AMS \(page 19\)](#) if necessary.
4. Select the decoder in AMS.
5. Click **HDMI OUTPUT** in the menu bar, then click the **SHOW ADVANCED** button.
6. Scroll down to the **Audio** section.
7. Click the **Analog Power** toggle switch to enable it. When enabled, the toggle switch will be green. Also note that the **Analog Power Status** indicator, above the toggle switch, will be green. This indicates that the external power supply is connected to the decoder.

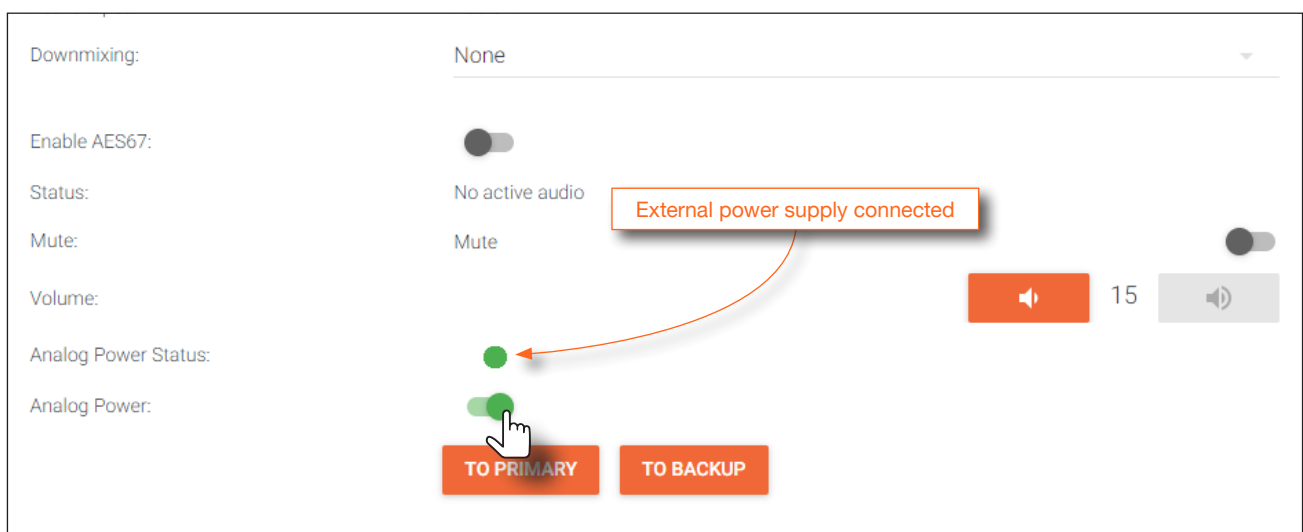

8. Audio from the source will now be heard on the **ANALOG OUT** port of the decoder. Note that when audio is de-embedded, it will not longer be audible using the HDMI OUT ports on the decoder.

Embedding Audio

Embedding audio will replace the existing HDMI audio source, normally heard on the output of the decoder. The analog audio will be heard on the **HDMI OUT** port of the decoder.

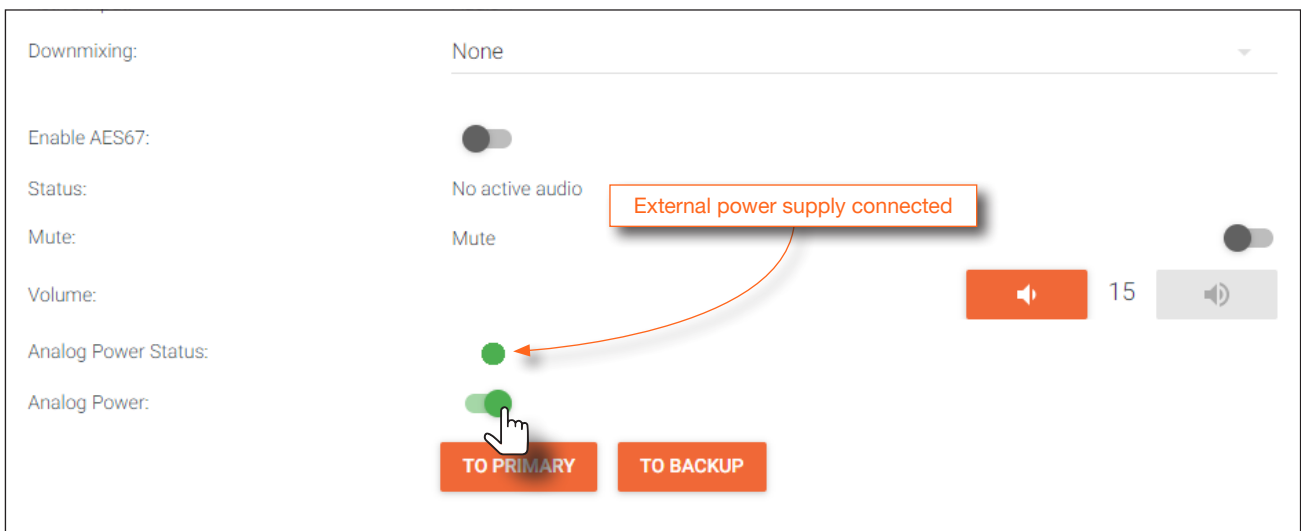

1. Connect the power supply to the DC 48V connector on the decoder.
2. Connect the audio source to the **AUDIO IN** ports, using the included 5-pin captive screw connectors. Refer to [Audio Connectors \(page 15\)](#) for wiring information.
3. Login to AMS. Refer to [Accessing Decoders in AMS \(page 19\)](#) if necessary.
4. Select the decoder in AMS.
5. Click **HDMI OUTPUT** in the menu bar, then click the **SHOW ADVANCED** button.
6. Scroll down to the **Audio** section.
7. Click the **Analog Power** toggle switch to enable it. When enabled, the toggle switch will be green. Also note that the **Analog Power Status** indicator, above the toggle switch, will be green. This indicates that the external power supply is connected to the decoder.



8. Audio from the source will now be heard on the **HDMI OUT** ports on the decoder.

Connecting RS-232 to OmniStream

The OmniStream decoders can directly receive commands from a control system or other host device using RS-232. RS-232 data can also be sent over IP. Refer to [Control Using RS-232 \(page 58\)](#) for more information. This section provides instructions on how to connect and configure an RS-232 host device to work properly with OmniStream.

1. Purchase or obtain a USB-to-RS-232 cable with a DE-9 male connector, and install the driver that came with the cable. The driver must be installed in order to assign a COM (serial) port on the computer, which is being used to connect to the OmniStream device.
2. Verify that the driver is properly installed by launching Windows Device Manager: Press  +  keys, simultaneously, then click **Device Manager** from the menu.

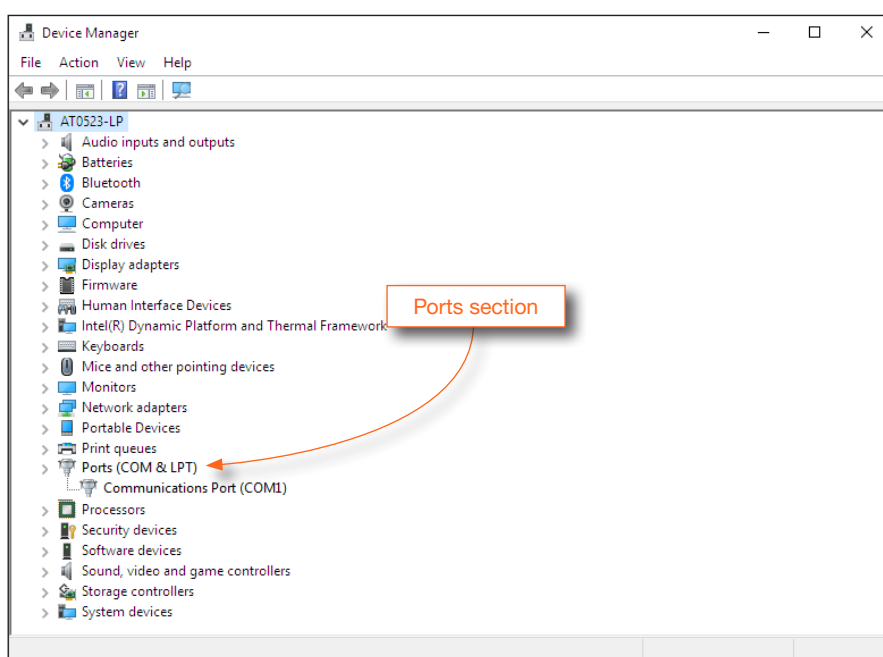
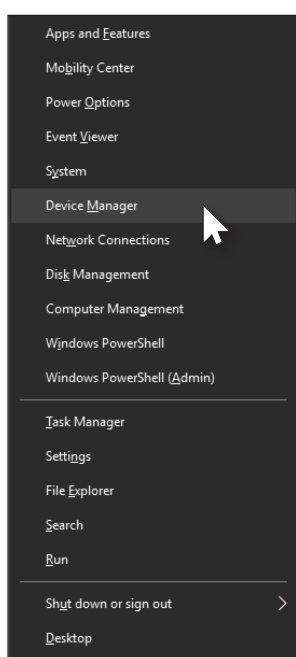

3. Locate the **Ports** section, within the **Device Manager** window, and verify that the driver has assigned a COM port for the USB cable. In the example above, COM1 was created.
4. Remove the DE-9 connector at the opposite end of the cable with wire cutters, and remove at least one inch of the cable insulation to expose each of the nine wires.
5. Locate a multimeter and set it to the “continuity” function.
6. Place one of the leads from the multimeter on pin 4 of the USB interface. The illustration below, shows the pin numbers for the USB connector.

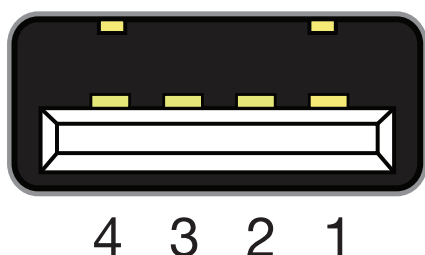

7. Take the other lead and probe each of the wires on the opposite end of the cable. When the wire connected to that pin is detected, the multimeter will emit an audible tone. Once this occurs, identify the current wire by moving it to the side.
8. Repeat step 6 for pin 3 and pin 2 on the USB connector.
9. Group the remaining wires and pull them aside. Electrical tape can be use to secure the wires to the outside of the USB cable. The following illustration shows the TX, RX, and GND wires, and the associated pin numbers on the USB connector.

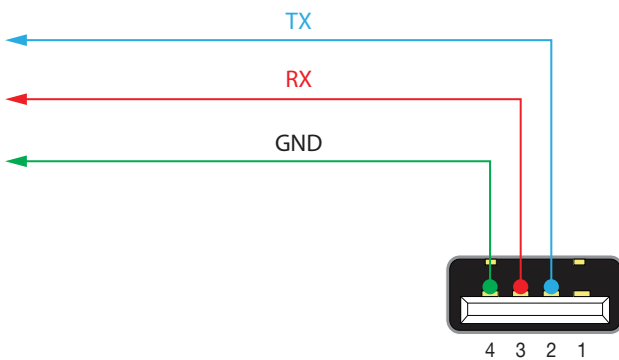

10. Remove at least 3/16" (5 mm) of insulation from each of these wires (TxD, RxD, and GND).
11. Locate the included captive screw block and connect the wires to each terminal, depending on which decoder is being connected.

AT-OMNI-121 connector

Open each of the terminals by turning the screws counter-clockwise, using a small regular screwdriver. Secure the wires by tightening the screws clockwise. Do not overtighten.

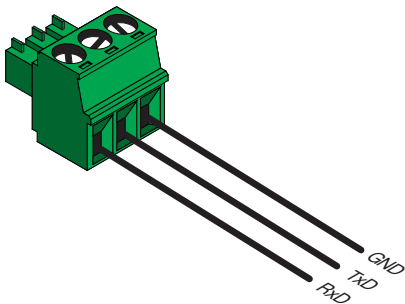

AT-OMNI-122 connector

Push the orange tabs, above the terminals, to insert each wire into the connector. Check to make sure that the proper wire is inserted into the correct terminal.

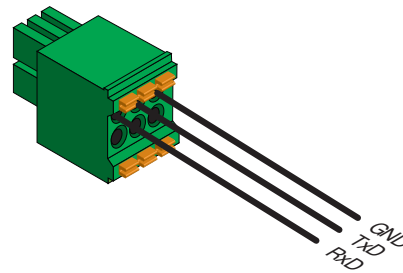

Control Using RS-232

RS-232 data can be sent over IP using one of three methods: RS-232 pass-through, RS-232 triggering, and TCP proxy.



NOTE: When configuring RS-232, always make sure to configure the correct baud rate, data bits, parity bit, stop bits, and flow control settings, as required by the connected device. These settings can be changed in the **Serial Port** section, under the **SERIAL** menu.

RS-232 Pass-Through

This method will pass-through RS-232 data, directly from a control system, to the sink device that is connected to the decoder.

1. Login to AMS. Refer to [Accessing Decoders in AMS \(page 19\)](#) if necessary.
2. Select the decoder in AMS.
3. Click **SERIAL** in the menu bar.
4. Configure the proper serial port settings under the **Serial Port** section for the connected device, then click the **SAVE** button.
5. Scroll down to the **Serial Configuration** section.
6. Click the **Mode** drop-down list and select the **Cli** option, then click the **SAVE** button.

Triggering Stored Commands

This method will trigger commands directly from the serial port on the decoder to the sink device. The decoder provides the following commands: **Display Off**, **Display On**, **Volume Up**, and **Volume Down**.

1. Login to AMS. Refer to [Accessing Decoders in AMS \(page 19\)](#) if necessary.
2. Select the decoder in AMS.
3. Click **SERIAL** in the menu bar.
4. Configure the proper serial port settings under the **Serial Port** section for the connected device, then click the **SAVE** button.
5. Scroll down to the **Serial Configuration** section.
6. Click the **Port** drop-down list and select the desired serial port.
7. Click the **Mode** drop-down list and select the **Output** option, then click the **SAVE** button.
8. Scroll down to the **Command** sections. Each section is labeled for the command type.
9. Click the **Mode** drop-down list and select the **Decoder** option.
10. Enter the associated command in the **ASCII** or **HEX** fields, then click the **SAVE** button. Refer to the User Manual for the sink device for the list of available commands.
11. Repeat steps 8 - 10 for each command, as desired. Trigger the desired command by executing the TrigRS232 command. Refer to the *OmniStream Application Programming Interface* for more information.

Using TCP Proxy

This method is used to send IP commands directly to the decoder, which are then output over RS-232 to the display (sink) device.

1. Login to AMS. Refer to [Accessing Decoders in AMS \(page 19\)](#) if necessary.
2. Select the decoder in AMS.
3. Click **SERIAL** in the menu bar.
4. Configure the proper serial port settings under the **Serial Port** section for the connected device, then click the **SAVE** button.
5. Scroll down to the **Serial Configuration** section.
6. Click the **Port** drop-down list and select the desired serial port.
7. Click the **Mode** drop-down list and select the **tcpproxy** option, then click the **SAVE** button.
8. Click the **Interface** drop-down list to select the interface (Ethernet port) that will be used to transmit the data.
9. Click the **Mode** drop-down list and select the **Decoder** option.
10. Enter the port number in the **Port** field. This number can be in the range from 0 to 65535.
11. Click the **SAVE** button to commit all changes.

Using the Virtual Matrix

1. Login to AMS. Refer to [Accessing Decoders in AMS](#) (page 19) if necessary.
2. Click the ☰ icon, in the upper-left corner of the AMS Dashboard.
3. Click on **Virtual Matrix**.

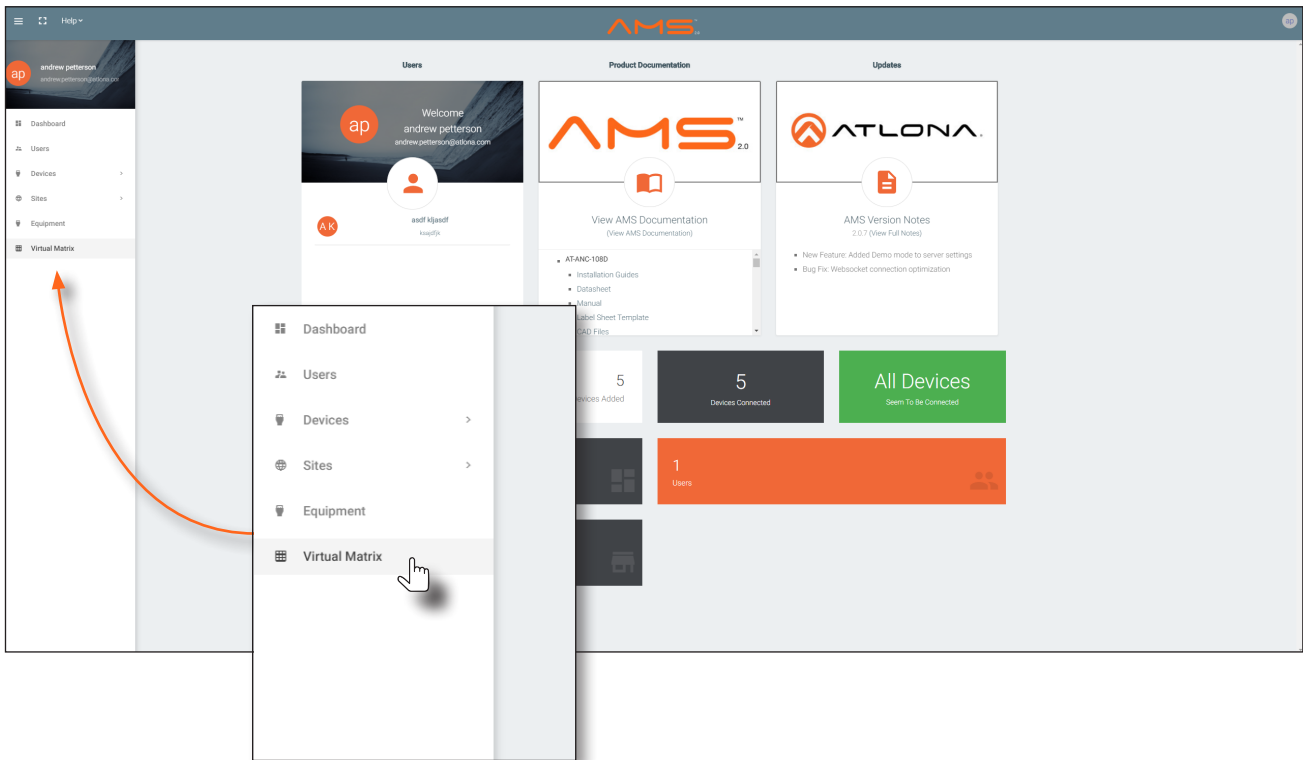

4. The **OmniStream Virtual Matrix** page will be displayed.



The screenshot shows the 'OmniStream Virtual Matrix' page. The page title is 'OmniStream Virtual Matrix' and it is for 'All Sites'. The page displays a grid of device connections. The columns represent different AT-OMNI-122 and AT-OMNI-121 decoders, and the rows represent different AT-OMNI-112 and AT-OMNI-111 decoders. The grid shows the connection status for each device, with green checkmarks indicating a successful connection and red 'X' marks indicating a failed connection. A legend at the top left of the grid shows the connection status icons: a green checkmark for 'Connected' and a red 'X' for 'Not Connected'.

Encoders / Decoders	LEGEND	AT-OMNI-122 192.168.11.181 8f omni-122-03048	Connected	AT-OMNI-121 192.168.11.184 8f omni-121-00461	Connected	AT-OMNI-122 192.168.11.86 192.168.11.87 8f omni-122-00242	Connected	AT-OMNI-121 192.168.11.89 8f omni-121-00064	Connected	AT-OMNI-122 192.168.11.160 192.168.11.161 8f omni-122-00381	Connected	AT-OMNI-121 192.168.11.165 8f omni-121-00688	Connected
AT-OMNI-112 192.168.11.89 8f omni-112-00349 Connected		HEM1 1	HEM1 2	HEM1 1	HEM1 2	HEM1 1	HEM1 2	HEM1 1	HEM1 2	HEM1 1	HEM1 2	HEM1 1	HEM1 2
AT-OMNI-111 192.168.11.50 8f omni-111-00020 Connected		HEM1 1	HEM1 2	HEM1 1	HEM1 2	HEM1 1	HEM1 2	HEM1 1	HEM1 2	HEM1 1	HEM1 2	HEM1 1	HEM1 2
AT-OMNI-112 192.168.11.51 8f omni-112-00003 Connected		HEM1 1	HEM1 2	HEM1 1	HEM1 2	HEM1 1	HEM1 2	HEM1 1	HEM1 2	HEM1 1	HEM1 2	HEM1 1	HEM1 2
AT-OMNI-112 192.168.11.115 8f omni-112-00122 Connected		HEM1 1	HEM1 2	HEM1 1	HEM1 2	HEM1 1	HEM1 2	HEM1 1	HEM1 2	HEM1 1	HEM1 2	HEM1 1	HEM1 2
AT-OMNI-112 192.168.11.183 192.168.11.148 8f omni-112-00039 Connected		HEM1 1	HEM1 2	HEM1 1	HEM1 2	HEM1 1	HEM1 2	HEM1 1	HEM1 2	HEM1 1	HEM1 2	HEM1 1	HEM1 2
AT-OMNI-111 192.168.11.167 8f omni-111-00020 Connected		HEM1 1	HEM1 2	HEM1 1	HEM1 2	HEM1 1	HEM1 2	HEM1 1	HEM1 2	HEM1 1	HEM1 2	HEM1 1	HEM1 2

5. Click on the **View** drop-down list and select **Control**.

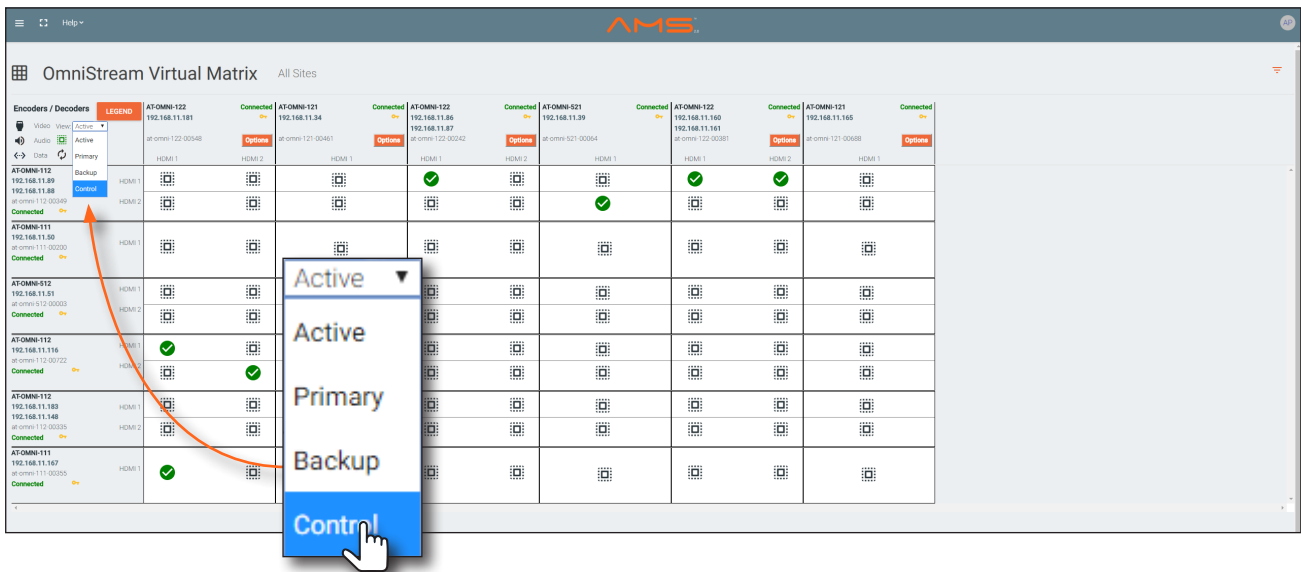

6. The Control screen will be displayed. In the Control screen, **HDMI** ports are replaced with control ports: **Port 1 In / Port 1 In** for encoders and **Port 1 Out / Port 2 Out** for decoders.

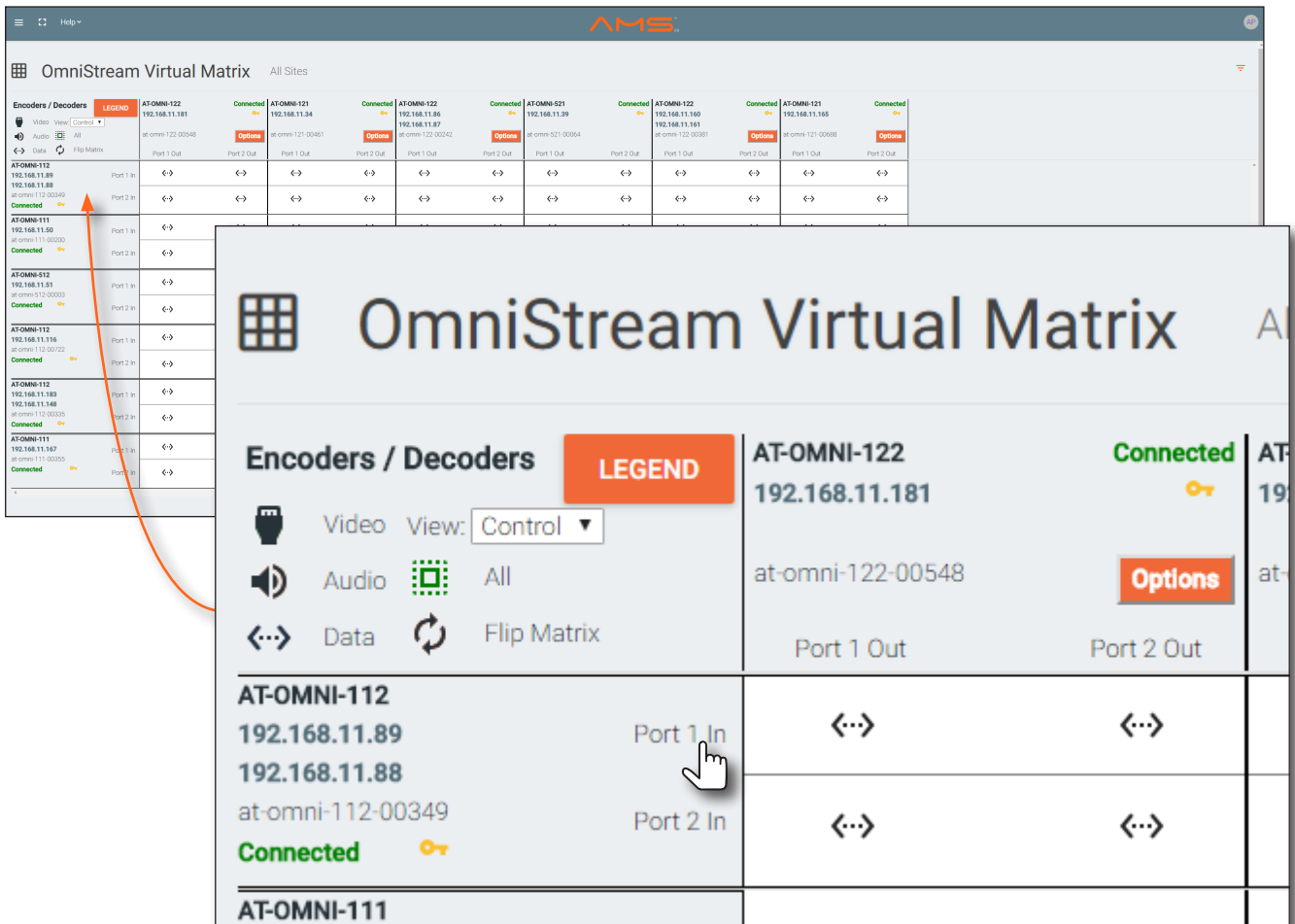

7. Click the **Options** button next to the desired decoder.

8. The **Crosspoint Options** dialog will be displayed.

Crosspoint Options: AT-OMNI-121 - 192.168.11.34

Serial Port 1:

Serial Mode - Port 1 ▼

Serial Port 2:

Serial Mode - Port 2 ▼

Modes:

RS232 Passthrough - Control System passes RS232 from Encoder input port through the Decoder output port

IR Passthrough - Control System passes IR from Encoder input port through the Decoder output port

Serial over IP Proxy - Mode that sends IP commands to the Decoder that are converted to RS232 commands

RS232 Trigger - Mode that allows sending stored RS232 commands through the Decoder output port

CEC Trigger Triggering CEC does not require any additional configuration. Control system may use "TrigCECX on" command

ADVANCED
CLOSE
SAVE

9. Click the **ADVANCED** button, near the bottom of the dialog. This will enable additional options in the Serial Port drop-down lists. In the **BASIC** mode, only **RS232 Passthrough** is available from drop-down list.

When the **ADVANCED** option is enabled, the following modes will be available. Refer to the list of modes, on the right-hand side of the dialog for a description of each.

The table below provides a summary of serial port control methods available for each encoder/decoder. Orange circles indicate that the feature is available on that port.

Control Method	AT-OMNI-111		AT-OMNI-112		AT-OMNI-121		AT-OMNI-122	
	Port 1	Port 2	Port 1	Port 2	Port 1	Port 2	Port 1	Port 2
RS-232 Pass-Through	●		●	●	●		●	●
IR Pass-Through		●		●		●		●
Serial over IP Proxy	●		●	●	●		●	●
RS-232 Trigger					●		●	●
RS-232 Encoder Buttons	●		●	●				

RS232 Passthrough

This is the most basic option: the control system (DTE device) sends RS-232 command from the encoder, downstream, to the decoder. The RS-232 commands are then received by a display (DCE device) or other sink device.

1. Select **RS232 Passthrough** from the **Serial Mode** drop-down list.

Crosspoint Options: AT-OMNI-121 - 192.168.11.34

<p>Serial Port 1:</p> <p>Serial Mode - Port 1 RS232 Passthrough</p>	<p>Serial Port 2:</p> <p>Serial Mode - Port 2 Not Used</p>	<p>Modes:</p> <p>RS232 Passthrough - Control System passes RS232 from Encoder input port through the Decoder output port</p> <p>IR Passthrough - Control System passes IR from Encoder input port through the Decoder output port</p> <p>Serial over IP Proxy - Mode that sends IP commands to the Decoder that are converted to RS232 commands</p> <p>RS232 Trigger - Mode that allows sending stored RS232 commands through the Decoder output port</p> <p>* CEC Trigger * Triggering CEC does not require any additional configuration. Control system may use "TrigCECX on" command</p>
---	--	---

Serial Mode changing, ensure that your connected encoder has the same mode.

Display Off

ASCII Command syntax

HEX Command syntax

Display On

ASCII Command syntax

HEX Command syntax

Volume Down

ASCII Command syntax

HEX Command syntax

Volume Up

*** Advanced Control * Options**

BASIC
CLOSE
SAVE

2. Click **SAVE** to commit changes, then click **CLOSE** to dismiss the dialog and return to the Virtual Matrix page. To return to the Virtual Matrix page without saving changes, click the **CLOSE** button to dismiss the dialog.

Serial over IP Proxy (TCP Proxy)

This method is used to send IP commands directly to the decoder, which are then output over RS-232 to the display (sink) device.

1. Select **Serial over IP Proxy** from the **Serial Mode** drop-down list. If it is not listed, make sure that the **Advanced** button is clicked, at the bottom of the dialog.
2. Scroll down to the **Serial Port** settings and provide the required settings. These settings must match the port settings on the display (sink) device.
 - a. Click the **Interface** drop-down list to select the interface (Ethernet port) that will be used to transmit the data.
 - b. Enter the port number in the **TCP Proxy Port** field. This number can be in the range from 0 to 65535.
 - c. Specify the baud rate, data bit, parity, stop bit, and flow control in the appropriate fields.

Crosspoint Options: AT-OMNI-121 - 192.168.11.34

Serial Port 1:

Interface	any
TCP Proxy Port	10000
Baud Rate	115200
Data Bit	7
Parity	None
Stop	2
Flow Control	None

BASIC
CLOSE
SAVE

3. Click **SAVE** to commit changes, then click **CLOSE** to dismiss the dialog and return to the Virtual Matrix page. To return to the Virtual Matrix page without saving changes, click the **CLOSE** button to dismiss the dialog.

RS232 Trigger

This method is used to trigger commands directly from the serial port on the decoder to the sink device. Commands are triggered using the TrigRS232 command, which can be executed by a driver or a control system. The decoder provides the following commands: **Display Off**, **Display On**, **Volume Up**, and **Volume Down**.

1. Select **RS232 Trigger** from the **Serial Mode** drop-down list. If it is not listed, make sure that the **Advanced** button is clicked, at the bottom of the dialog.
2. Enter the desired command, under the **Display Off**, **Display On**, **Volume Down**, and **Volume Up** fields. In the example below, the hex command for the “display off” command has been entered in the **HEX Command syntax** field, under **Display Off**.



NOTE: Command data can be entered in either the **ASCII Command syntax** or **HEX Command syntax** fields. When a command is entered in one of these fields, the command data will automatically be converted and added to the adjacent field.

Crosspoint Options: AT-OMNI-121 - 192.168.11.34

<p>Serial Port 1:</p> <p>Serial Mode - Port 1 RS232 Trigger</p>	<p>Serial Port 2:</p> <p>Serial Mode - Port 2 Not Used</p>	<p>Modes:</p> <p>RS232 Passthrough - Control System passes RS232 from Encoder input port through the Decoder output port</p> <p>Serial over IP Proxy - Mode that sends IP commands to the Decoder that are converted to RS232</p>
--	---	--

Display Off

ASCII Command syntax
h0\xBF\x11pW\x8A\xC2\x85\x

HEX Command syntax
68 30 bf 11 70 57 8a c2 85 b0

Hex command string



3. Scroll down to the **Serial Port** settings and provide the required baud rate, data bit, parity, stop bit, and flow control settings. These settings must match the port settings for the display (sink) device.

Serial Port 1:

Baud Rate
115200

Data Bit
8

Parity
None

Stop
1

Flow Control
None

4. Click **SAVE** to commit changes, then click **CLOSE** to dismiss the dialog and return to the Virtual Matrix page. To return to the Virtual Matrix page without saving changes, click the **CLOSE** button to dismiss the dialog.

Trigger the desired command by executing the TrigRS232x command, where x is the port number on the decoder.

Example: TrigRS2321 [command]

Creating a Cross Connection

Depending on the mode configured on the decoder, a cross-connection must be created to enable communication between the decoder and encoder.

1. Return to the Virtual Matrix page.



2. Locate the desired encoder and decoder where the cross-connection will be created. In the following example, **Port 1 In** and **Port 1 Out** on the AT-OMNI-112 and AT-OMNI-122 (in the upper left corner of the Virtual Matrix), will be selected.
3. Click the **< ... >** icon to create the cross-connection. Once a cross-connection is created, it will be represented by a "C" in a purple circle, as shown below. To remove the connection, click the "C" icon.

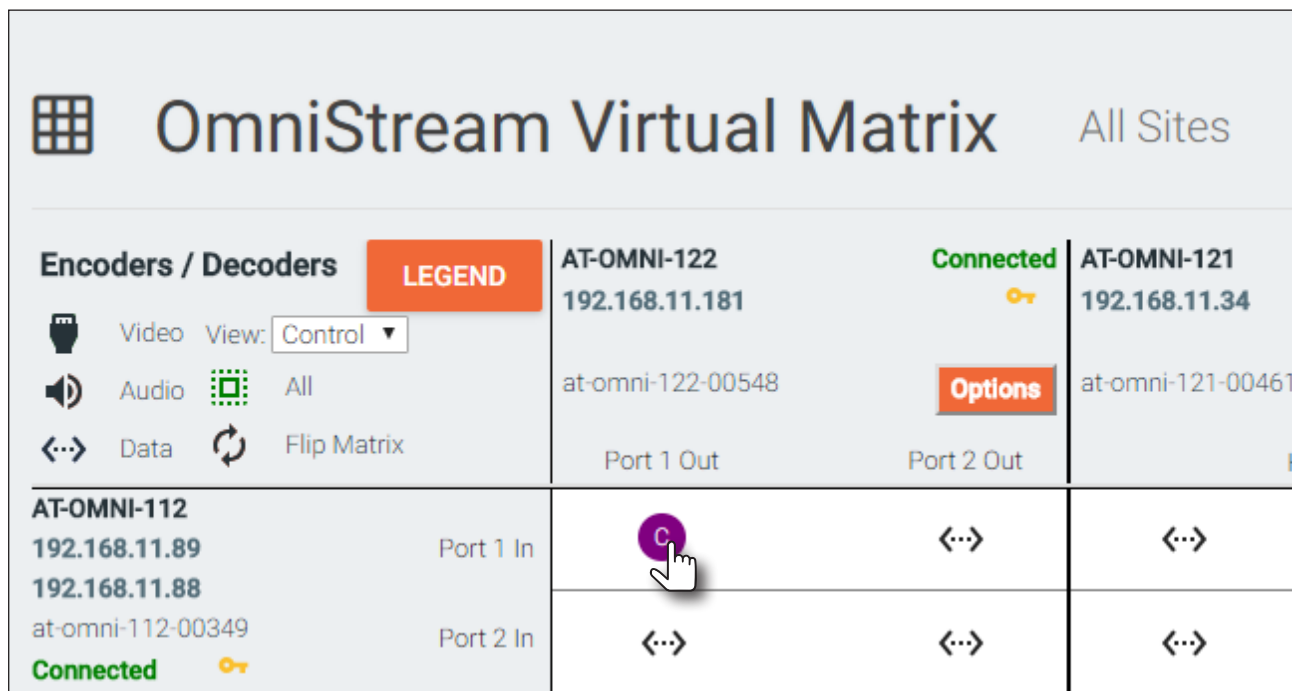

802.1X Authentication

802.1X is a server-based port authentication which restricts unauthorized (rogue) clients from connecting to a Local Area Network through a public port. In its simplest form, 802.1X usually involves three parties: supplicant (client device), authenticator (Ethernet switch or WAP), and an authentication server. Before the device is permitted on the network, port communication is restricted to Extensible Authentication Protocol over LAN (EAPOL) traffic. If the device passes the authentication process, the authentication server notifies the switch, allowing the client to access the LAN. The illustration below shows the basic architecture.

WARNING: Connecting an 802.1X-enabled decoder to a network without an active or operational authentication server, will result in a decoder that does not function until the expected message is returned from a RADIUS server. If it is unclear as to whether the network uses 802.1X authentication, consult the IT administrator for assistance.

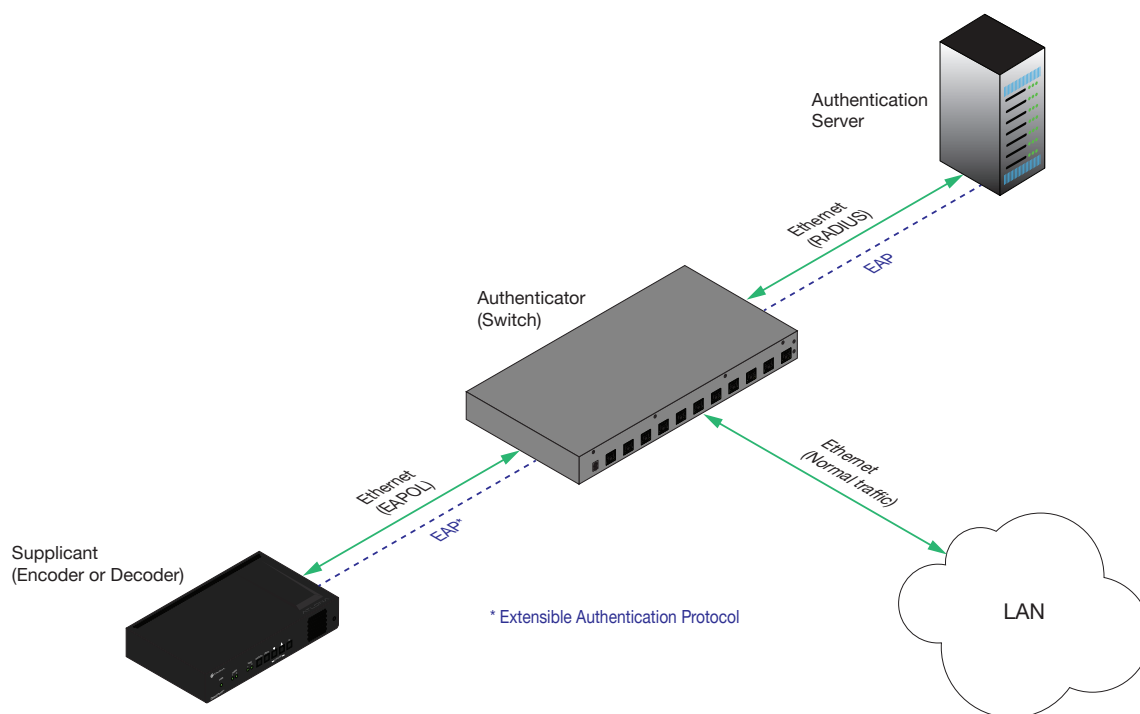

Three options are available on both the OmniStream encoder and decoder.

Protocol	Description
none	802.1X protocol disabled
PEAP/MSCHAPv2	Protected EAP; requires basic credentials in addition to a CA (certificate authority) certificate.
EAP-TLS	EAP Transport Layer Security; requires a client certificate, client private key, and CA (certificate authority) certificate.

1. Login to AMS. Refer to [Accessing Decoders in AMS \(page 19\)](#), if necessary.
2. Click **Devices** > **All** and select the desired encoder from the **Device List**.
3. Click **NETWORK** in the menu bar.



NOTE: If using dual-channel decoders, both **Network 1 (eth1)** and **Network 2 (eth2)** will need to be set up, depending upon the system requirements.

4. Click the **SHOW ADVANCED** button to expand the options under both **Network** window groups.
5. Click the **802.1x Mode** drop-down list, at the bottom of the page, and select the desired authentication method. In the example below, **PEAP/MSCHAPv2** is selected.

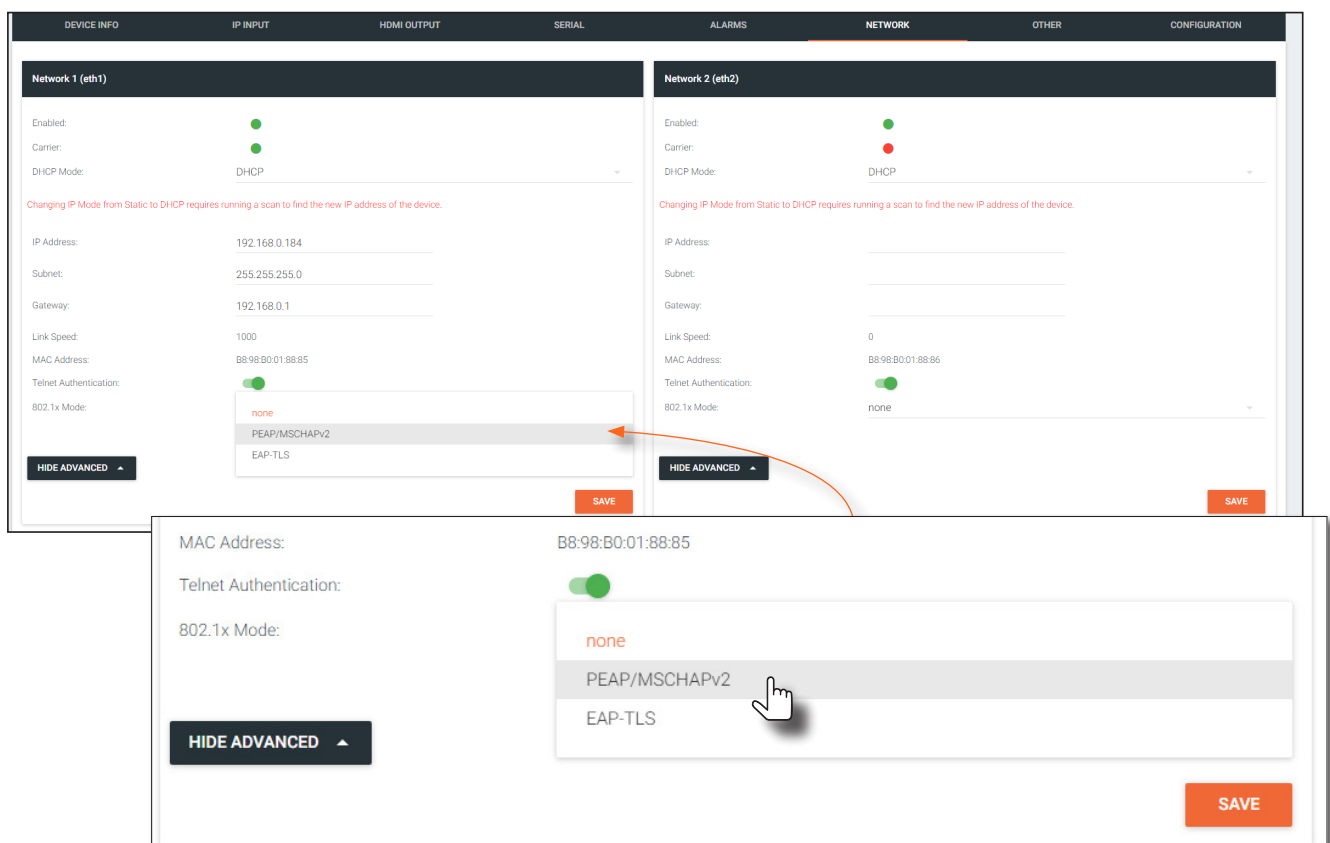

The screenshot displays the Network configuration interface for two interfaces: Network 1 (eth1) and Network 2 (eth2). Both are currently set to DHCP mode. The 802.1x Mode dropdown menu is open, showing three options: 'none', 'PEAP/MSCHAPv2', and 'EAP-TLS'. A red arrow points to the 'PEAP/MSCHAPv2' option. Below the main configuration area, a detailed view of the 802.1x Mode settings is shown, with 'PEAP/MSCHAPv2' selected and a mouse cursor hovering over it. The MAC Address is B8:98:B0:01:88:85 and Telnet Authentication is enabled.

6. Once a method is selected, the required fields for that method will be displayed. Enter the required information in each field. For the **PEAP/MSCHAPv2** option, the fields are described as follows:

- **Identity**
Enter the identity of the authentication server in this field. PEAP uses this field to identify the correct authentication server which will process the credentials. For example, if foo@authserv.com is entered, then this identifies AUTHSERV as the RADIUS (authentication) server.
- **CA certificate**
Click the **Browse...** button to select the certification authority (CA) certificate. To remove a certificate, click the **Remove** button.
- **Username**
Enter the username in this field
- **Password**
Enter the password in this field.

MAC Address: B8:98:B0:01:88:85

Telnet Authentication:

802.1x Mode: PEAP/MSCHAPv2 ▼

Identity:

Password:

CA certificate:

7. Click **SAVE** to commit changes.
8. Refer to the table below for a list of available authentication methods. An orange dot indicates that this field will be displayed as part of the method.

Authentication Method	Identity	Password	CA Certificate	CA Certificate	Client Private Certificate
PEAP/MSCHAPv2	●	●	●		
EAP-TLS			●	●	●

AES67 Audio

AES67 audio is a standard for high-performance audio streaming over IP, providing several features such as synchronization, media clock identification, and connection management. AES67 does not support bitstream/compressed audio formats, such as Dolby® Digital, and others. Source audio must be transmitted as LPCM up to eight channels at 192 kHz / 24-bit.

1. Login to AMS. Refer to [Accessing Decoders in AMS \(page 19\)](#), if necessary.
2. Click **Devices** > **All** and select the desired encoder from the **Device List**.
3. Click **SESSION** in the menu bar.
4. Locate the **Audio** section, under the desired **Stream**, and click the **Enable AES67** toggle switch to enable this feature. When enabled, the toggle switch will be green.

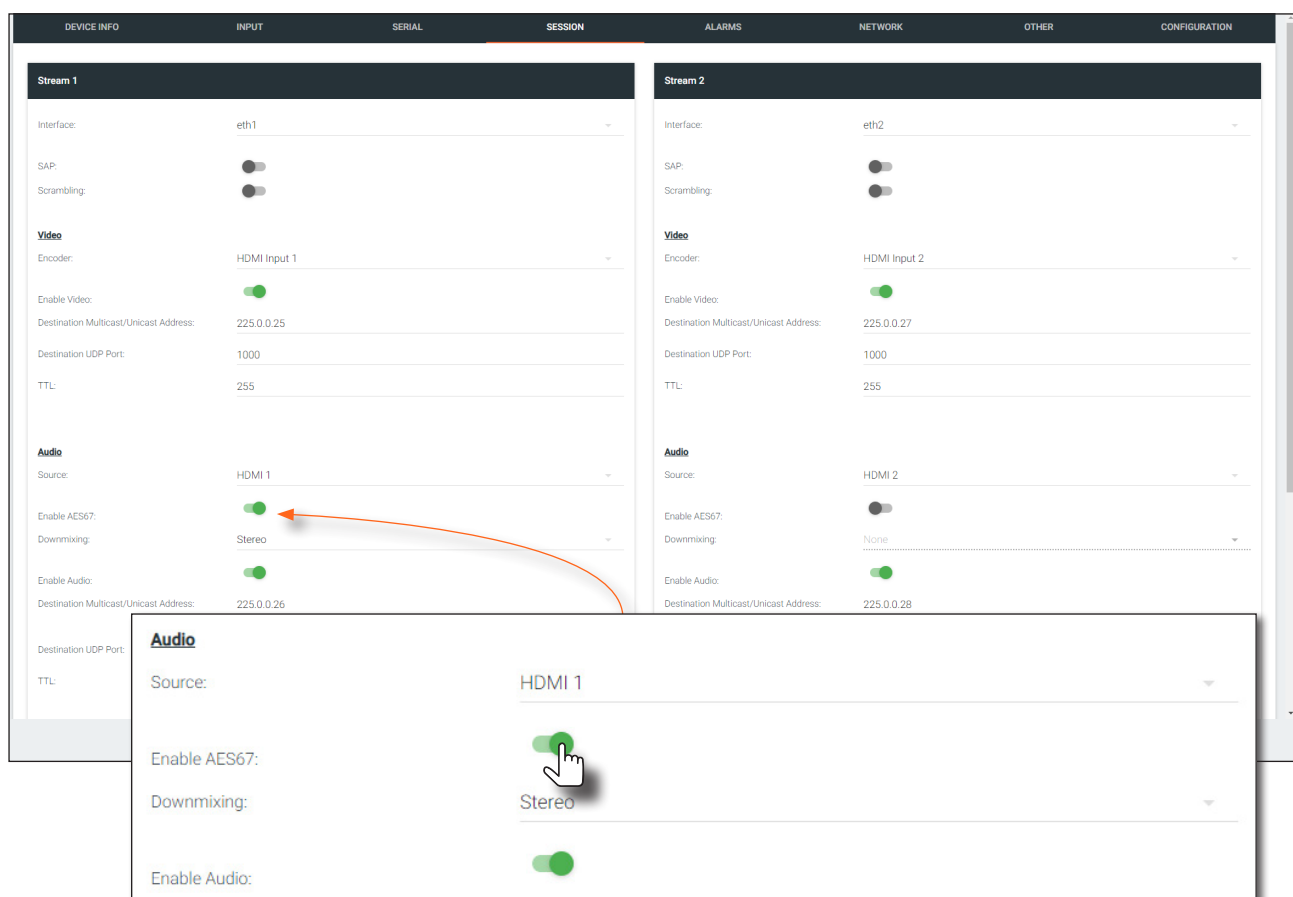

5. Select the type of downmixing from the **Downmixing** drop-down list, if desired. Available options are: **None**, **Mono**, or **Stereo**.
6. Click the **SAVE** button within the **Stream** window group.
7. Go to the decoder interface and click **OTHER** in the menu bar.
8. Click **SAP** in the upper-left corner of the screen.
9. Click the **Enable** toggle switch to enable SAP. When enabled, the toggle switch will be green. If the decoder, Dante controller, or DSP is to receive AES67 audio, this step is *required*.
10. Click the **SAVE** button on the **SAP** page.

Scrambling

OmniStream supports 128-bit Advanced Encryption Standard (AES) scrambling and is required for HDCP-encrypted streams. Scrambling can be enabled or disabled through AMS, and can be applied to individual sessions. In order for Scrambling to function properly, it must be enabled on both the encoder session and all decoders subscribed to a stream that is a part of a scrambled session. The scrambling key on both encoder and subscribed decoder(s) must be identical. When enabled, the default scrambling key is “scrambling”.

Standard Method

1. Login to AMS. Refer to [Accessing Decoders in AMS \(page 19\)](#), if necessary.
2. Click **Devices** > **All** and select the desired encoder from the **Device List**.
3. Click **HDMI OUTPUT** in the menu bar.
4. Under the desired HDMI output, click the **Enabled** toggle switch, under **Descrambling**, to enable it. When enabled, the toggle switch will be green and the **Key** field will be displayed.
5. Enter the desired scrambling key in the **Key** field.



IMPORTANT: In order for descrambling to function correctly, the same key that was specified on the encoder (scrambling) must be entered in the Key field. Also note that If a user-defined key is specified, then it must be a minimum of eight alphanumeric characters. Special characters and spaces are not permitted.

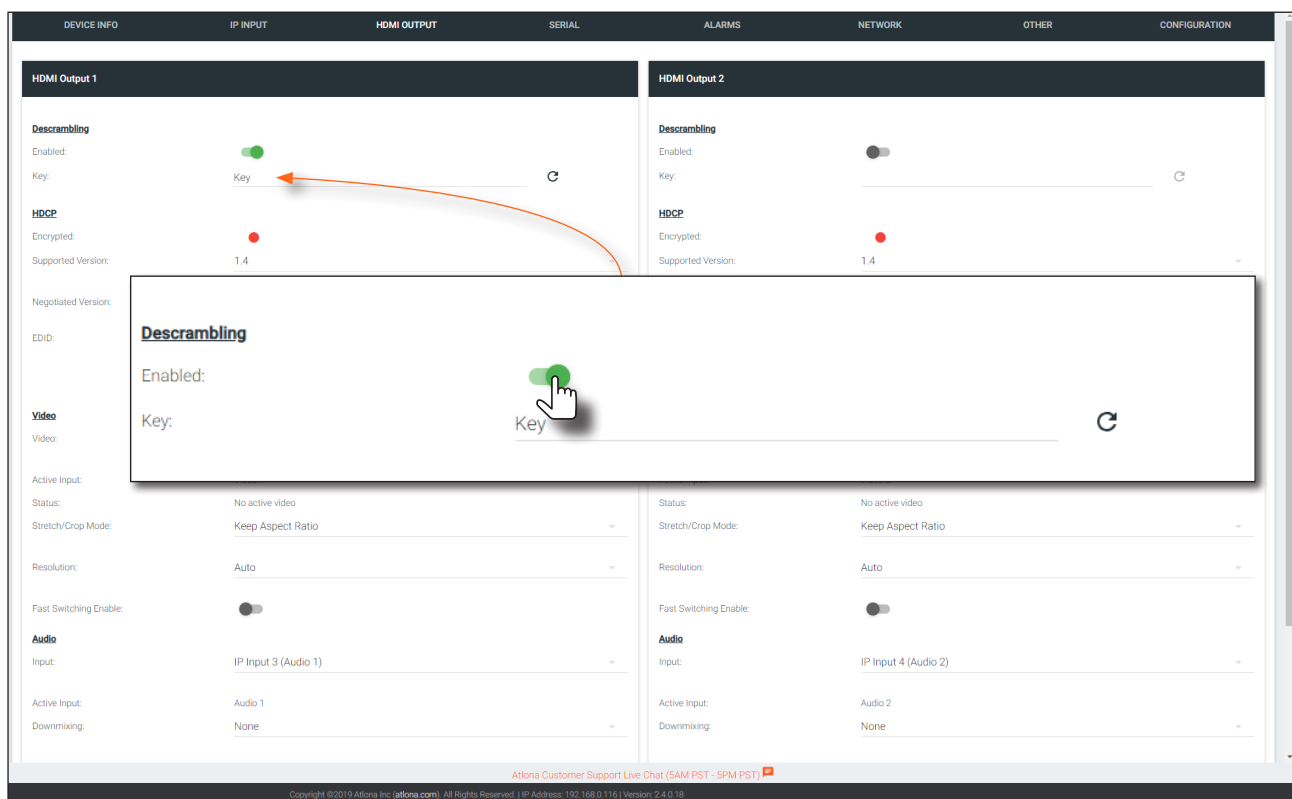

The screenshot displays the configuration page for HDMI outputs. The 'HDMI Output 1' section shows 'Descrambling' as 'Enabled' (green toggle) and a 'Key' field. The 'HDMI Output 2' section shows 'Descrambling' as 'Disabled' (grey toggle). A modal window is open over the 'Key' field of HDMI Output 1, with a hand cursor clicking the green 'Enabled' toggle. The modal contains the text 'Descrambling', 'Enabled:', and a 'Key:' input field. At the bottom of the page, there is a footer with copyright information: 'Copyright ©2019 Atlona Inc. (atlona.com). All Rights Reserved | IP Address: 192.168.0.116 | Version: 2.4.0.18'.

6. Click the **Save** button at the bottom of the page to commit the changes.

Using the Virtual Matrix

1. Access the Virtual Matrix. Refer to [The Virtual Matrix \(page 130\)](#) for more information.
2. Locate the desired encoder or decoder. Scrambling is handled on the encoder; descrambling is handled on the decoder.
3. Click the yellow key icon. The Scrambling dialog box will be displayed. If the key icon for a decoder is clicked, then the Descrambling dialog box will be displayed.

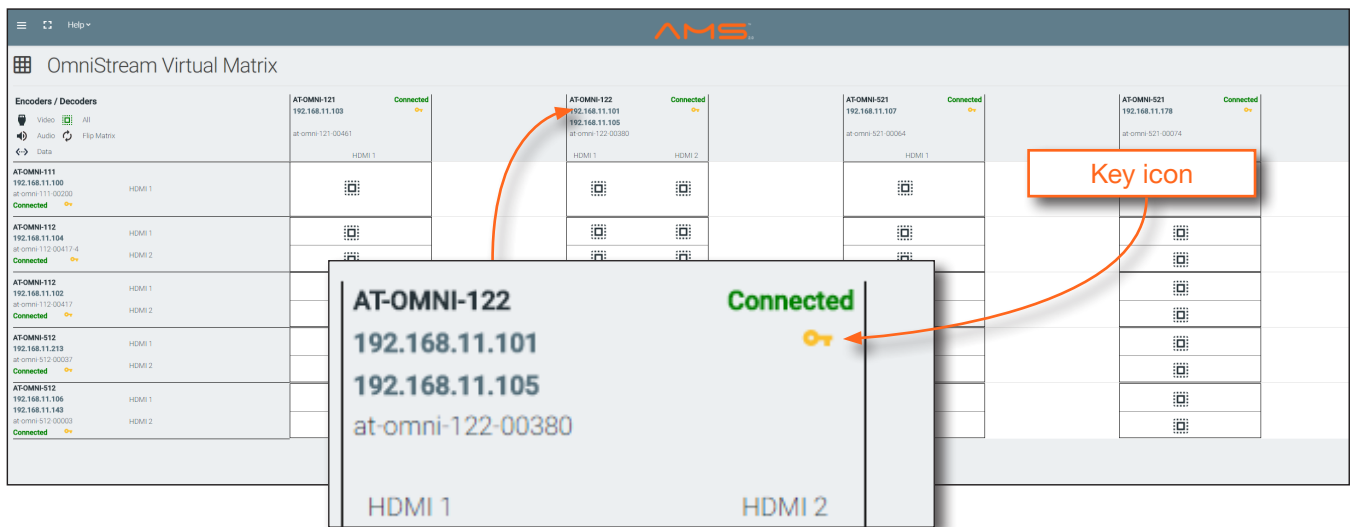

4. Click the **Enable** toggle switch to enable scrambling for the desired session.

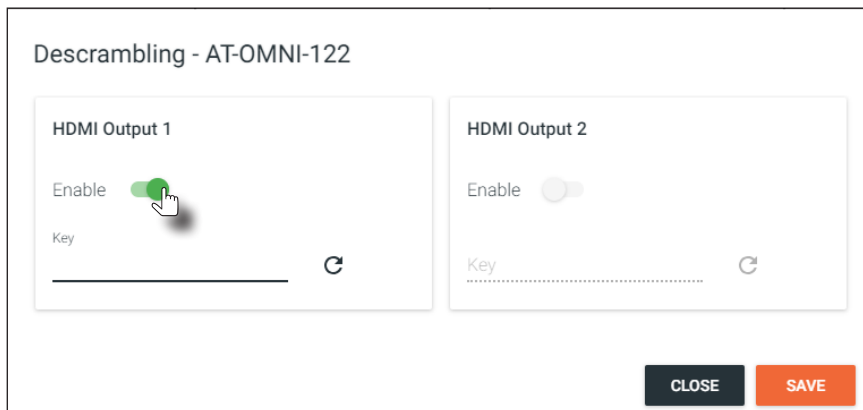

5. Enter the desired scrambling key using one of the following methods:
 - Manual enter a user-defined key in the **Key** field.
 - Click the  icon to generate a random key using AMS. Each time this icon is clicked, a new scrambling key will be generated.
6. Repeat the above process for each session.
7. Click the **Save** button to commit the changes.

Creating Video Walls

Introduction

Before proceeding with creating video walls, review the tables below. These tables provide information on video wall size, maximum timing, color space, and bit depth.



NOTE: OmniStream video walls do not support 1080i sources.

The following table lists the maximum video wall size, based on the resolution of the source.

Resolution	Maximum Video Wall Size
4Kp60	2 x 2
4Kp30	16 x 16
1080p60	n x n (no limit)

The following table provides maximum timing, color space, and bit-depth specifications when video walls are enabled.

Number of Channels	Resolution	Refresh Rate	Color Space	Bit Depth
1	1920 x 1080p	60 Hz	4:4:4	12-bit
2	1920 x 1080p	30 Hz	4:4:4	12-bit



NOTE: When video walls are enabled, the output resolution at the decoder endpoint is dependent on both the number of channels on the decoder and the input resolution received from the encoder. Refer to the table below for details.

Input Resolution (from Encoder)	Output Resolution (AT-OMNI-121)	Output Resolution (AT-OMNI-122)
1280 x 720p	1280 x 720p	1280 x 720p
1920 x 1080p @ 60 Hz	1920 x 1080p @ 60 Hz	1920 x 1080p @ 30 Hz
> 1920 x 1080p (up to UHD)	1920 x 1080p @ 60 Hz	1920 x 1080p @ 30 Hz

Landscape Mode

The following diagram will be used to illustrate how to configure a 2 x 2 video wall. The details of this diagram are listed below:

- Four decoders are subscribed to a single encoder. Each decoder is connected to a display.
- The encoder is transmitting a 3840 x 2160 video signal.
- The top two displays have been accidentally mounted upside down.

Figure 1.1: Landscape-mode 2x2 video wall requiring adjustment.

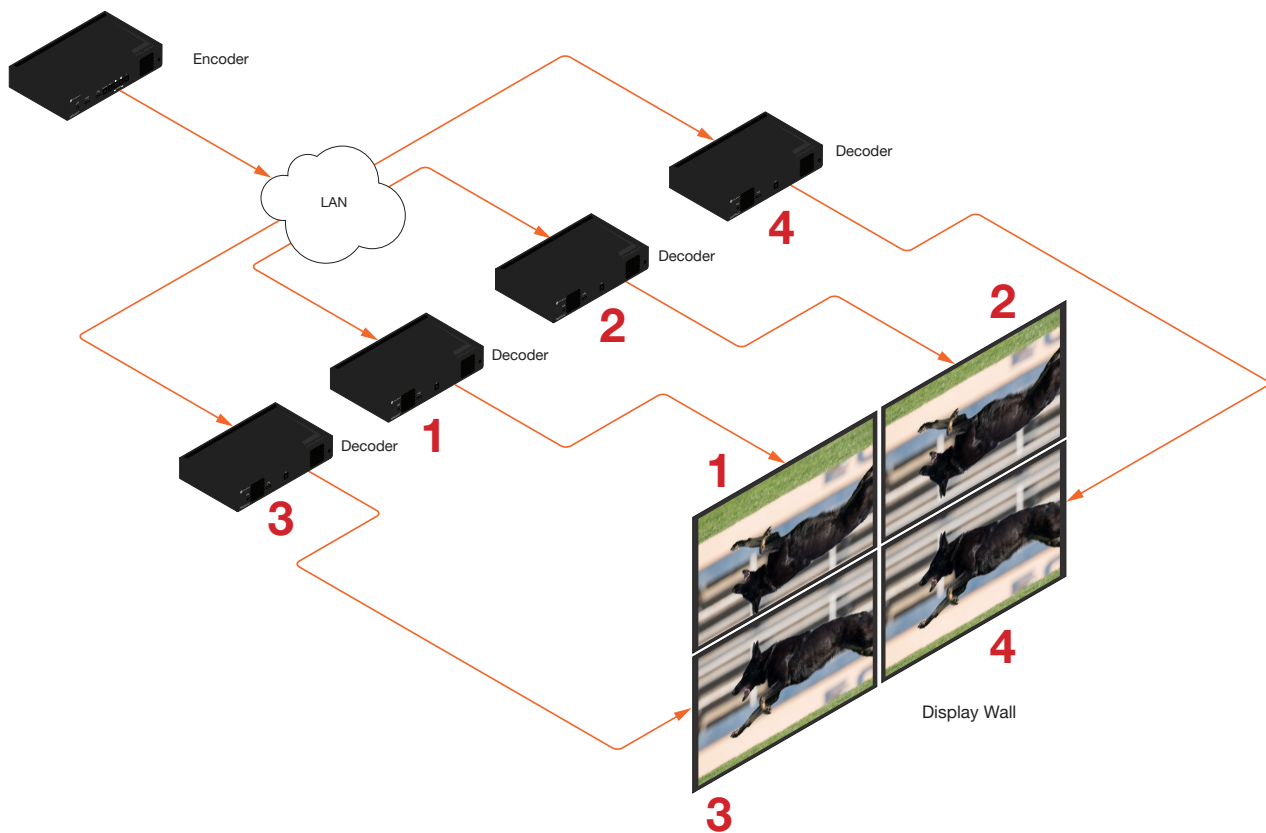

This diagram presents some challenges that need to be met:

- Since there are four displays, the image from each decoder will need to be scaled to one-fourth of the total resolution. The crop-and-scale feature will be used to provide the correct output.
- The top two displays have been mounted upside-down. To meet this challenge, the rotate feature will be applied to these two displays.

Note that the order in which each image is cropped, scaled, and/or rotated is arbitrary. In this example, the configuration process will begin with Display 1, in the top left.

1. Access the built-in web server for the OmniStream decoder and login using the required username and password. The default credentials are listed below:

Username: admin
 Password: Atlona

2. Click **HDMI OUTPUT** in the menu bar.

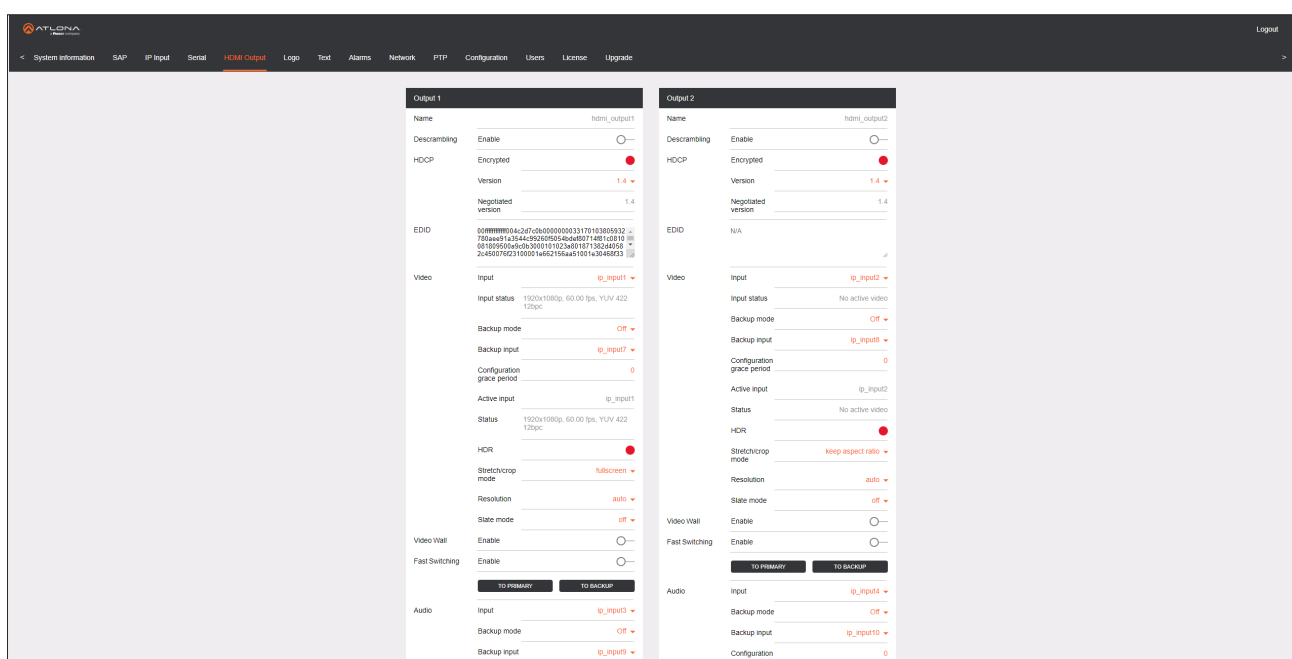

3. Locate the **Resolution** option, in the **Video** section and select 1920x1080. This will scale the output resolution to 1920x1080.

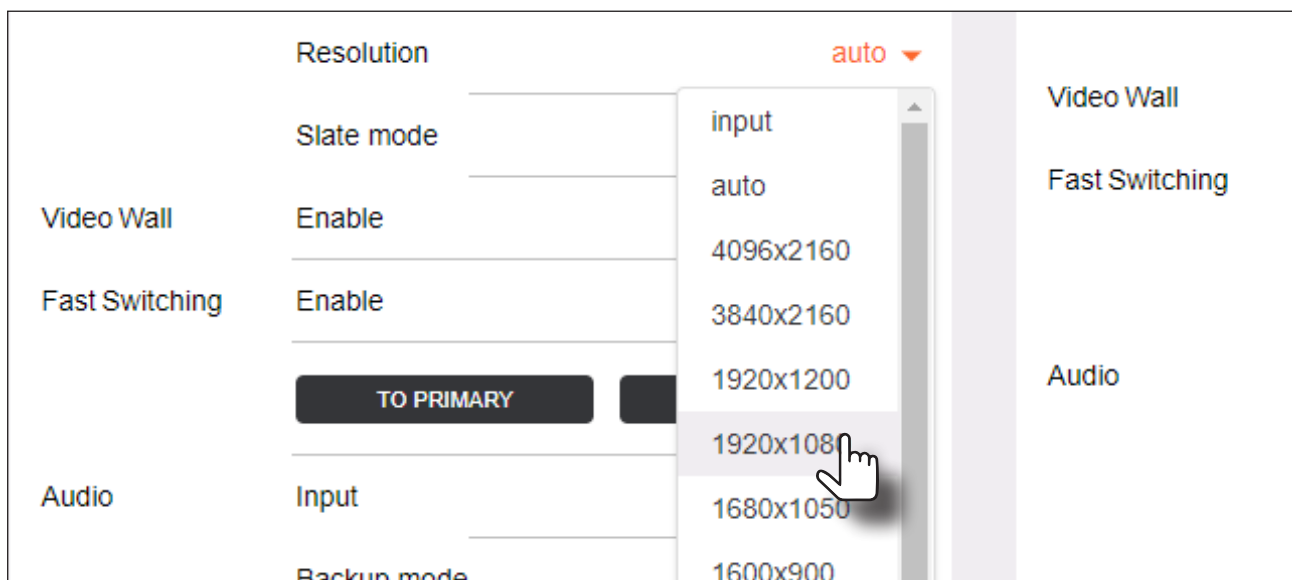

- Click the **Stretch/Crop Mode** drop-down list and select Full Screen. This guarantees that the image will fill the screen.

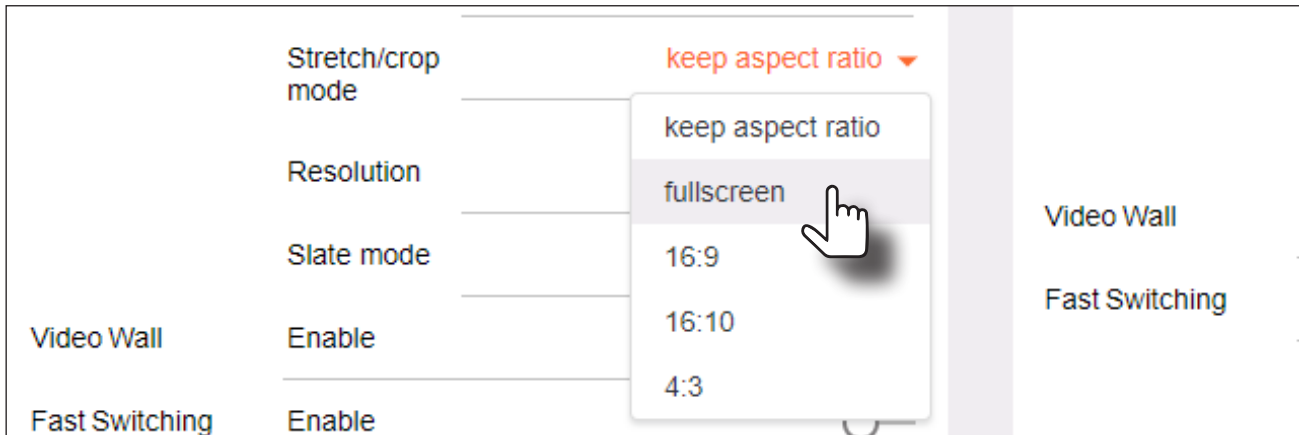

- Under the **Video Wall** section, click the **Enable** toggle to activate the **Video wall** option. Once enabled, the **Video wall** section will be expanded and display all available options.

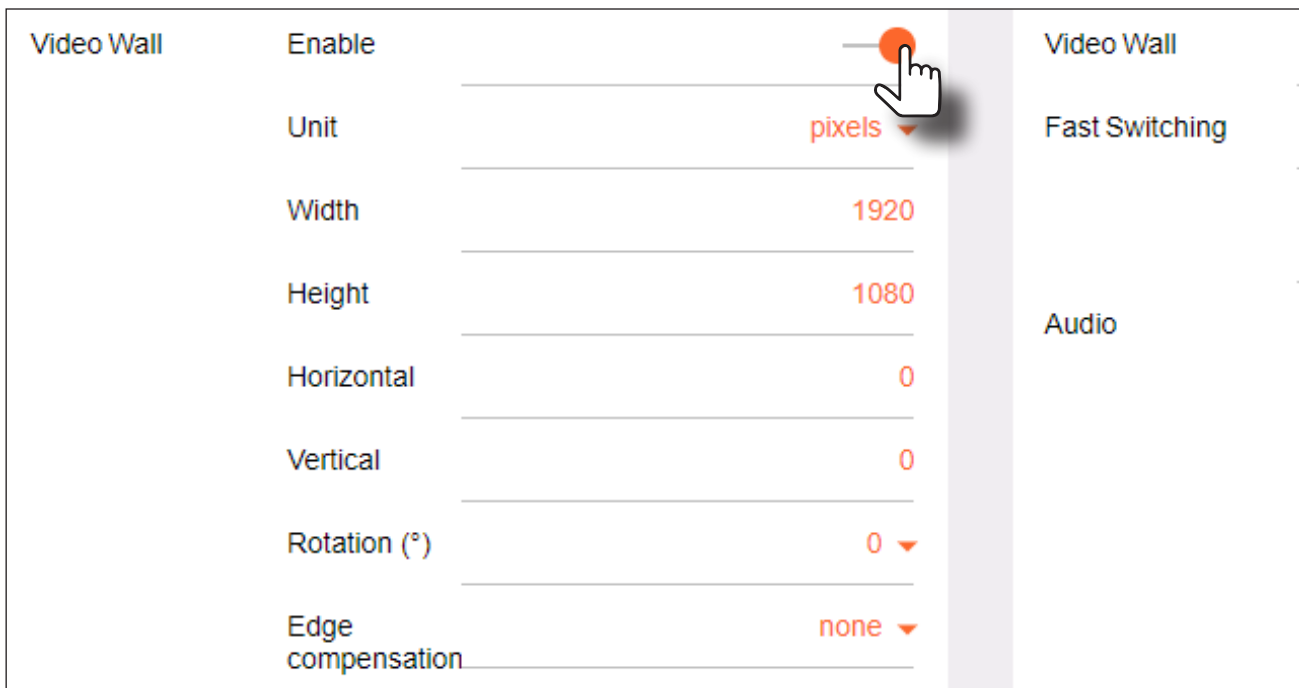

- Click the **Unit** drop-down list to select the unit of measure. In this example, **Pixels** (the default value) will be used.



IMPORTANT: When using Millimeters or Inches, two additional fields will be available: **Video Wall Width** and **Video Wall Height**. When entering these values, the following requirement must be observed: **Video Wall Width** must be greater than or equal to the display width. **Video Wall Height** must be greater than or equal to the display height.

- Enter the horizontal and vertical resolution of the display in the **Width** and **Height** fields. This is the size of the source to be used for this window of the video wall. The table on the next page, lists width and height examples for a 2x2 video wall, with the specified source resolution.

Source resolution	Width (pixels)	Height (pixels)
3840 x 2160 (UHD)	1920	1080
1920 x 1080 (1080p)	960	540

8. Enter the number of video wall rows in the **Horizontal** field and the number of columns in the **Vertical** field. These values are the pixel start position (upper left most pixel). The table below, lists left and right coordinates for a 2x2 video wall, with the specified source resolution.

Source resolution	Upper Left	Upper Right	Lower Left	Lower Right
3840 x 2160 (UHD)	0, 0	1920, 0	0, 1080	1920, 1080
1920 x 1080 (1080p)	0, 0	960, 0	0, 540	960, 540

9. Click the **Rotation** drop-down list to select the rotation angle of the image. In this example, select **180** from the drop-down list. The image will be flipped, vertically. This step is only applied when configuring the two top displays.

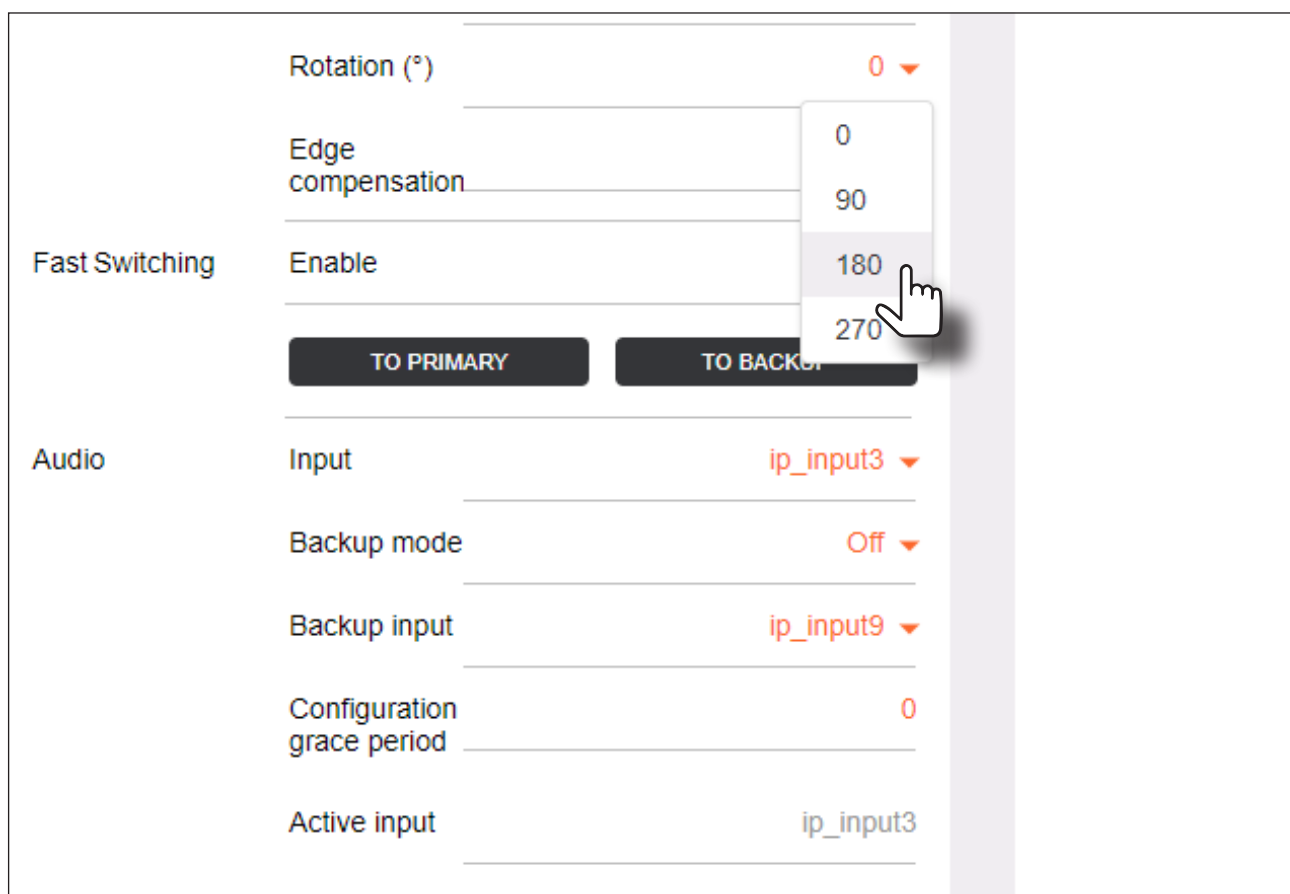

NOTE: 0 and 180 used for landscape mode video walls and 90 and 270 for portrait mode. Refer to [Portrait Mode \(page 80\)](#) for more information.

The image on Display 1 in the upper-left corner, as illustrated below, has been cropped and rotated and is now displayed correctly. At this point, one-fourth of the video wall has been configured.

Figure 1.2: Landscape-mode 2x2 video wall requiring adjustment.

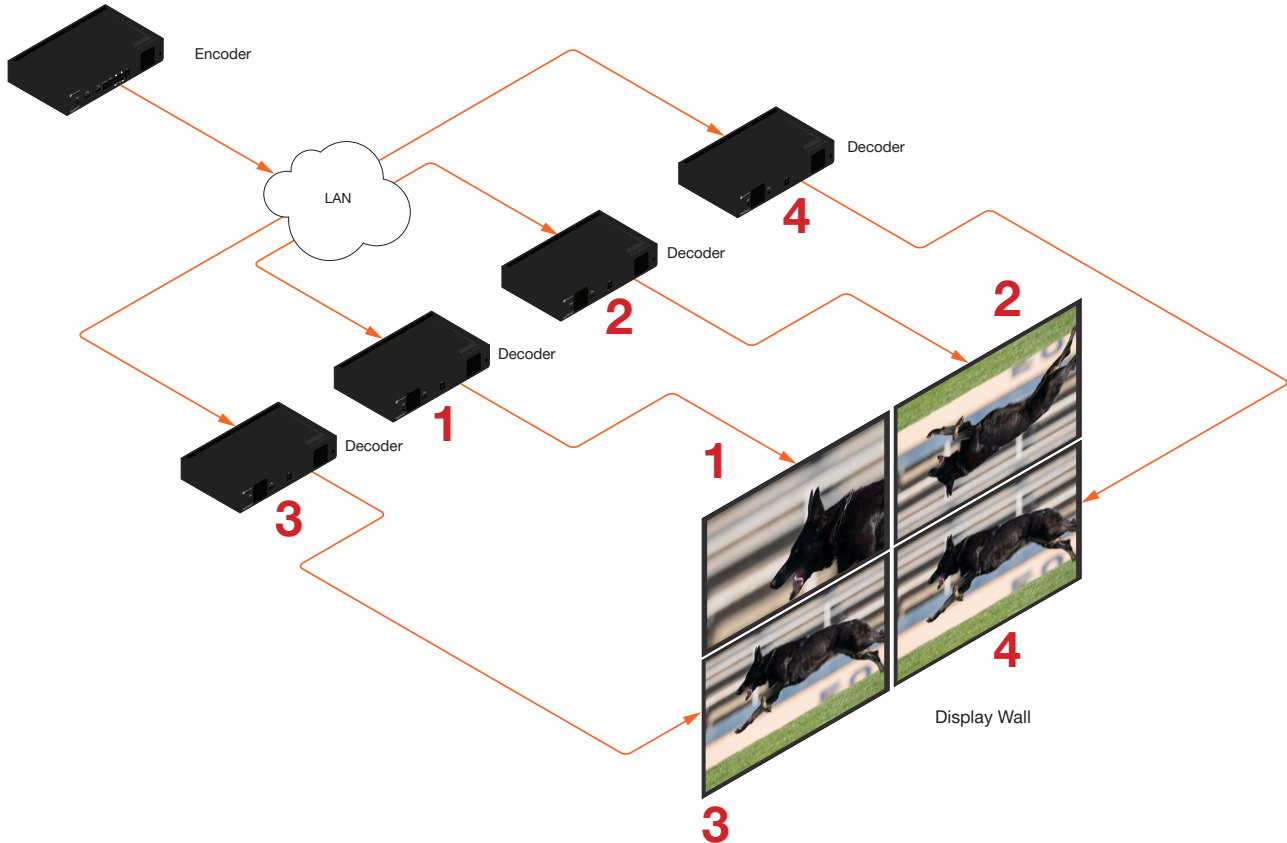

10. Click the **SAVE** button at the bottom of the screen to commit changes.
11. Repeat steps 3 through 9 for decoders 2, 3, and 4. Note that in the example below, decoders 3 and 4 will not require any rotation. Therefore, make sure the **Rotation** option is set to 0 for decoders 3 and 4.



IMPORTANT: When using dual-channel decoders, the **Rotation** feature can only be used when a single HDMI channel is active. Image rotation is not supported on dual-channel decoders when both HDMI channels are active. Single-channel decoders do not have this restriction.

Once all four decoders have been properly configured, the image will be correctly displayed across all four displays. Refer to the illustration on the next page.

12. Check the image, on each display, and make sure they are aligned correctly with the other images on the video wall. Use the **Edge Compensation** drop-down list to adjust bevel compensation, if necessary. Refer to [Bezel Compensation \(page 86\)](#) for more information.

Figure 1.3: Landscape-mode 2 x 2 video wall displayed correctly.

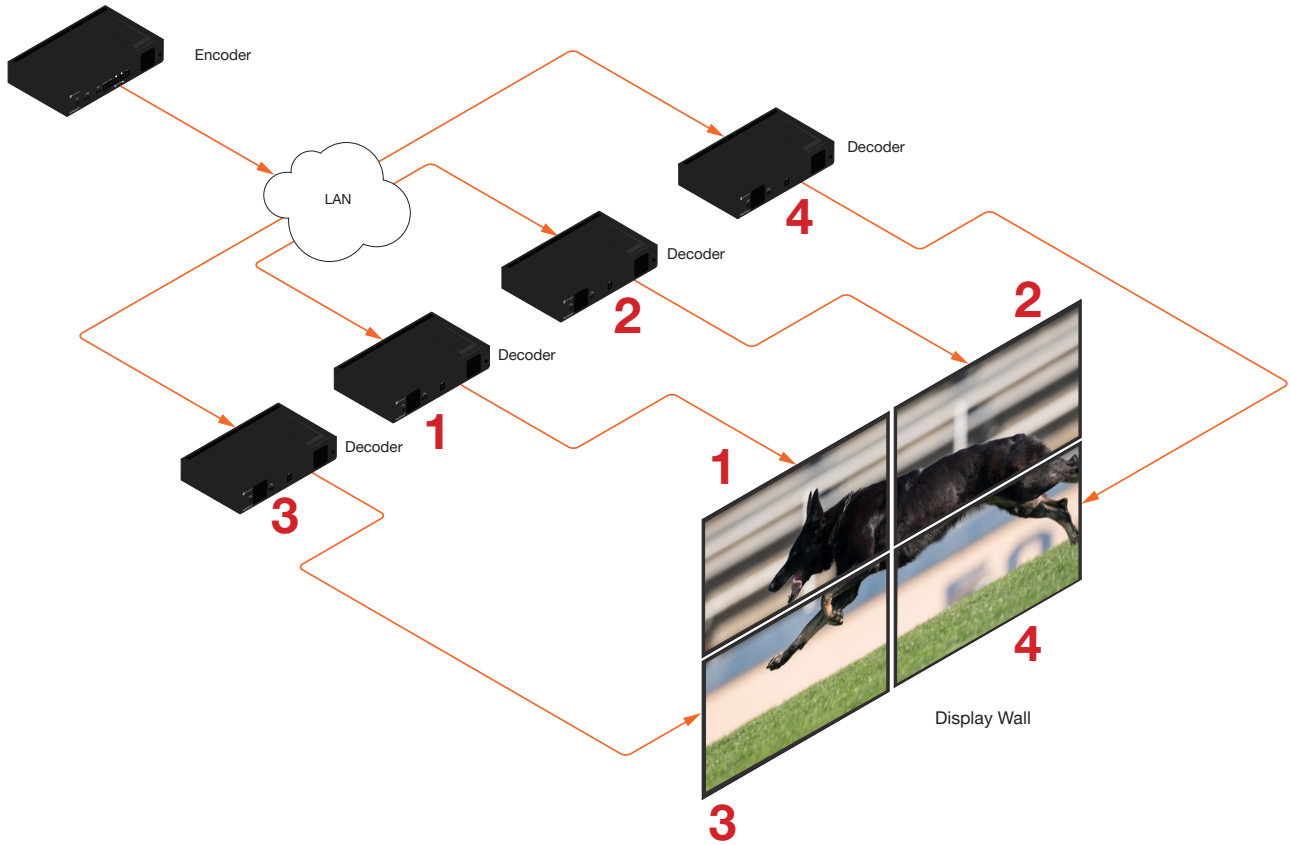

Portrait Mode



IMPORTANT: Portrait Mode is only supported on single-channel decoders.

Images can be rotated 90° or 270° to create portrait-oriented video walls. The steps to configure portrait-oriented video walls is very similar to creating landscape video walls.

A similar scenario to the landscape video wall challenge will be used to illustrate how to configure a 1 x 4 portrait-oriented video wall. The details of this diagram are listed below:

- Four decoders are subscribed to a single encoder. Each decoder is connected to a display.
- The encoder is transmitting a 3840 x 2160 video signal.
- Display 2 and 3 have been mounted upside-down.

Figure 2.1: Portrait-mode video wall requiring adjustment.

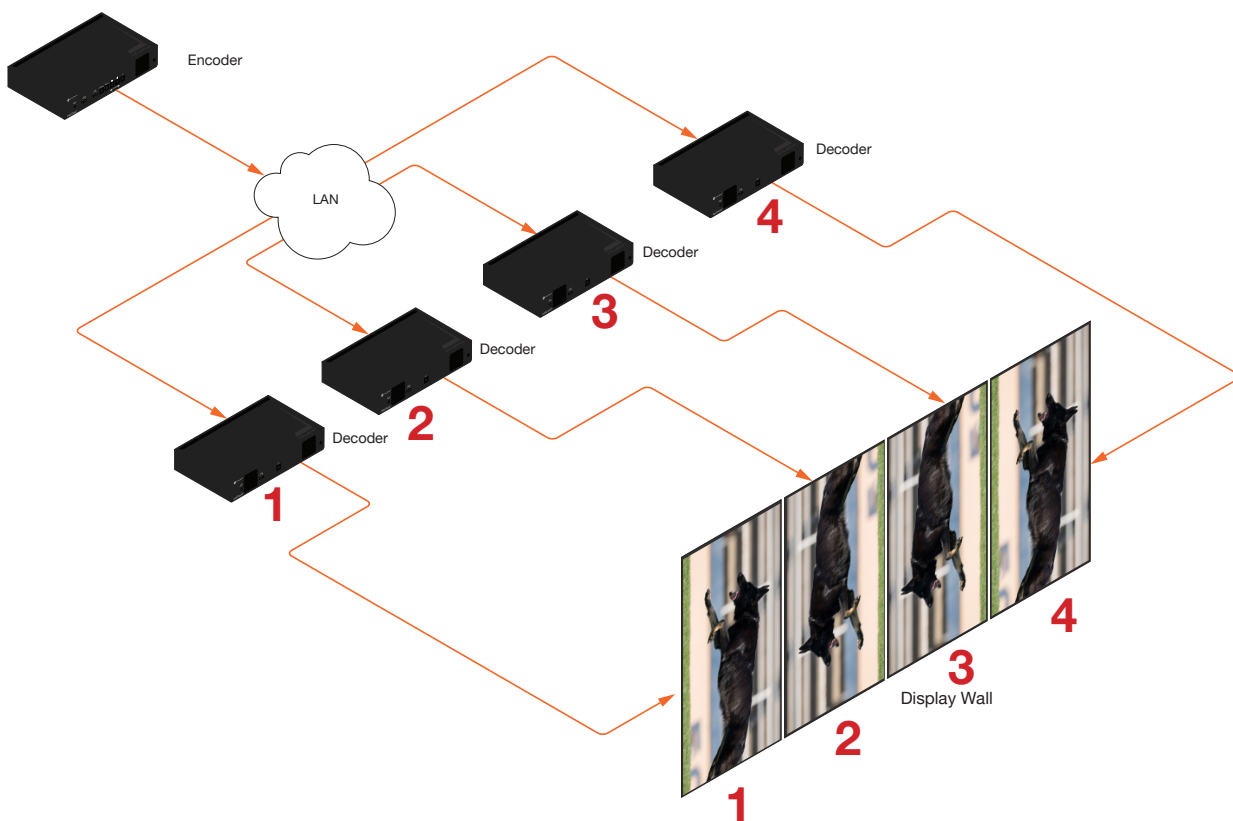

As with the landscape video wall, this diagram presents some challenges that need to be met:

- Since there are four displays, the image from each decoder will need to be scaled to one-fourth of the total resolution. The crop-and-scale feature will be used to provide the correct output.
- Display 2 and 3 have been mounted upside-down. To meet this challenge, the images must be flipped horizontally and rotated 90°, which gives a total rotation angle of 270°. Display 1 and 4 only need to be rotated 90°.

Note that the order in which each image is cropped, scaled, and/or rotated is arbitrary. In this example, the configuration process will begin with Display 1.

1. Access the built-in web server for the OmniStream decoder and login using the required username and password. The default credentials are listed below:

Username: admin
 Password: Atlona

2. Click **HDMI OUTPUT** in the menu bar.

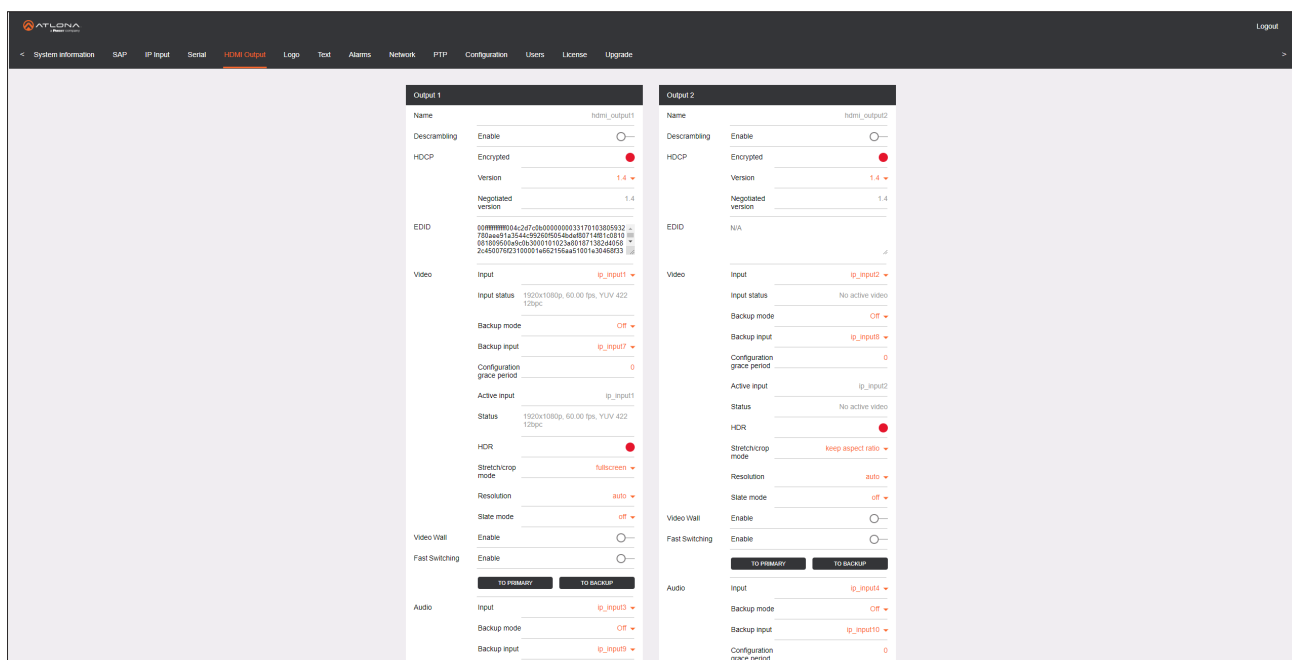

3. Locate the **Resolution** option, in the **Video** section and select 1920x1080. This will scale the output resolution to 1920x1080.

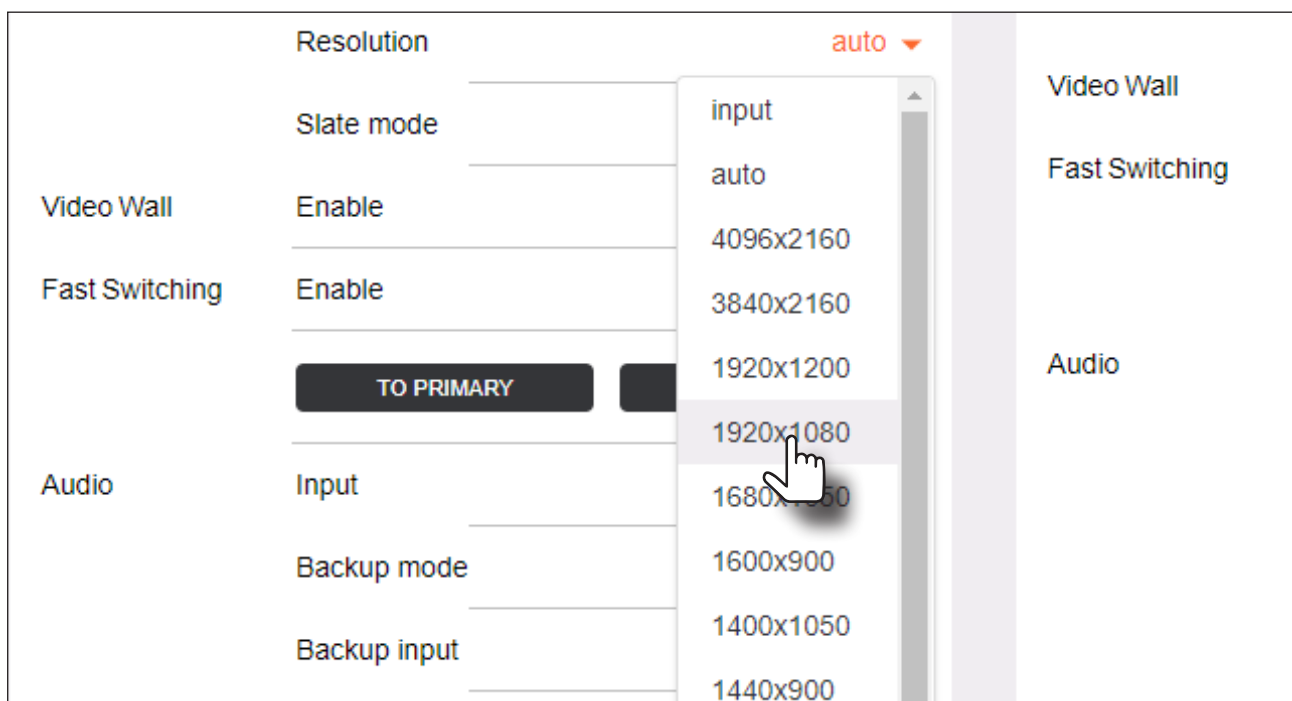

- Click the **Stretch/Crop Mode** drop-down list and select **Full Screen**. This guarantees that the image will fill the screen.

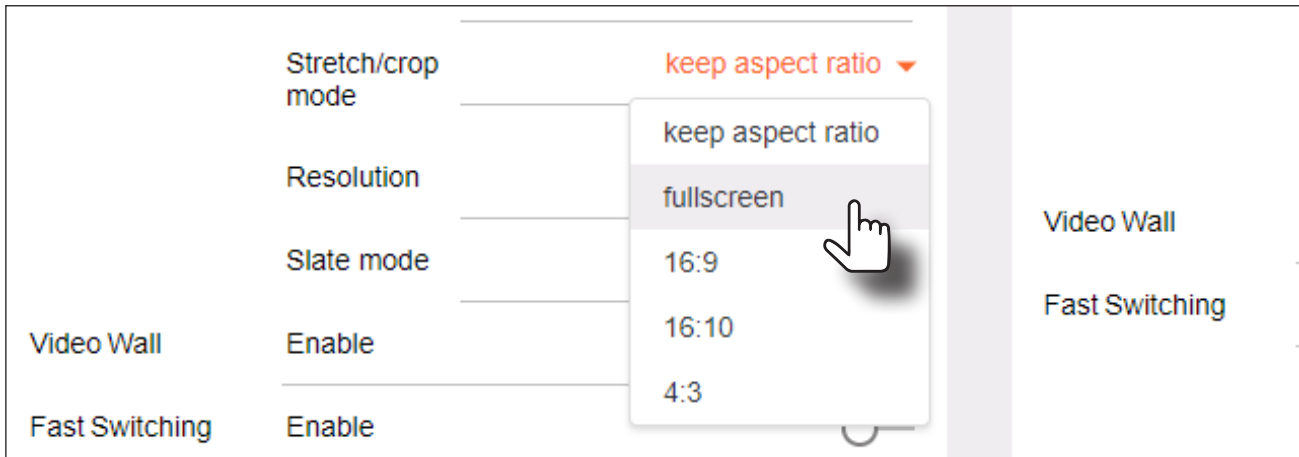

- Under the **Video Wall** section, click the **Enable** toggle to activate the **Video wall** option. Once enabled, the **Video wall** section will be expanded and display all available options.

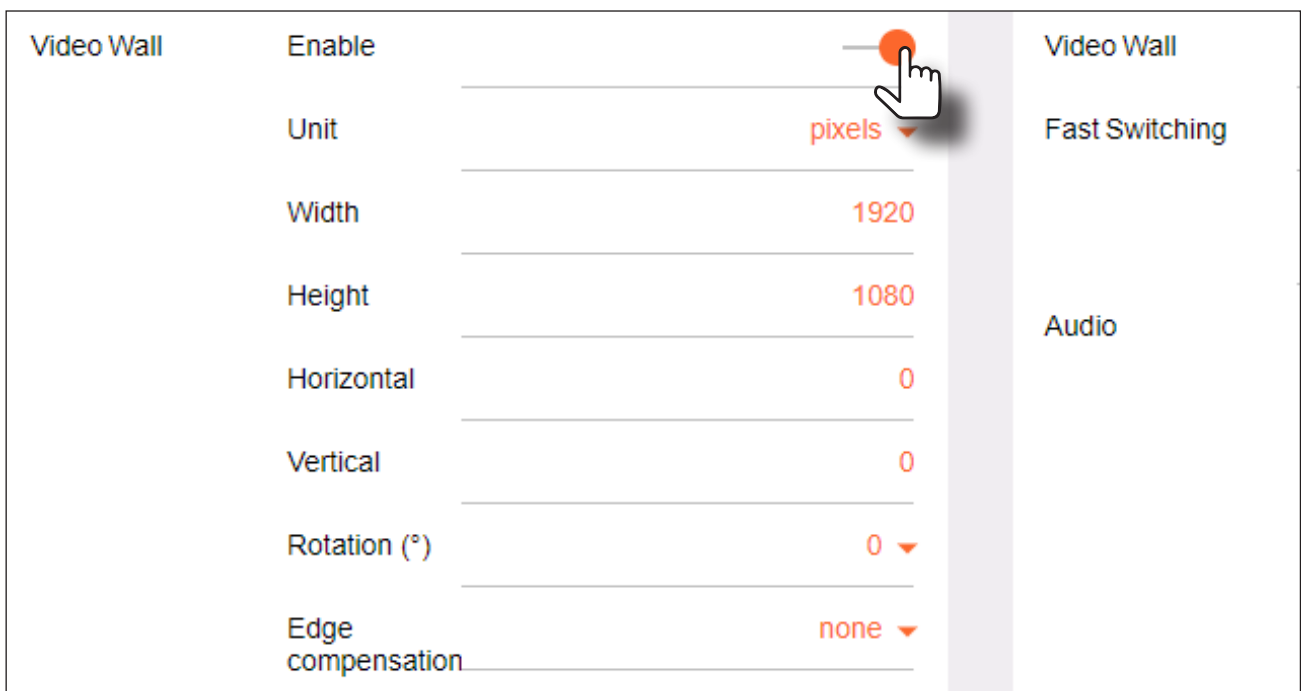

- Click the **Unit** drop-down list to select the unit of measure. In this example, **Pixels** (the default value) will be used.

IMPORTANT: When using Millimeters or Inches, two additional fields will be available: **Video Wall Width** and **Video Wall Height**. When entering these values, the following requirement must be observed: **Video Wall Width** must be greater than or equal to the display width. **Video Wall Height** must be greater than or equal to the display height.

- Enter the horizontal and vertical resolution of the display in the **Width** and **Height** fields. This is the size of the source to be used for this window of the video wall. The table on the next page, lists width and height examples for a 2x2 video wall, with the specified source resolution.

Source resolution	Width (pixels)	Height (pixels)
3840 x 2160 (UHD)	1920	1080
1920 x 1080 (1080p)	960	540

8. Enter the number of video wall rows in the **Horizontal** field and the number of columns in the **Vertical** field. These values are the pixel start position (upper left most pixel). The table below, lists left and right coordinates for a 1x4 video wall, with the specified source resolution.

Source resolution	Upper Left	Upper Right	Lower Left	Lower Right
3840 x 2160 (UHD)	0, 0	1920, 0	0, 1080	1920, 1080
1920 x 1080 (1080p)	0, 0	960, 0	0, 540	960, 540

9. Click the **Rotation** drop-down list to select the rotation angle of the image. In this example, select **90** from the drop-down list to rotate the image as portrait.

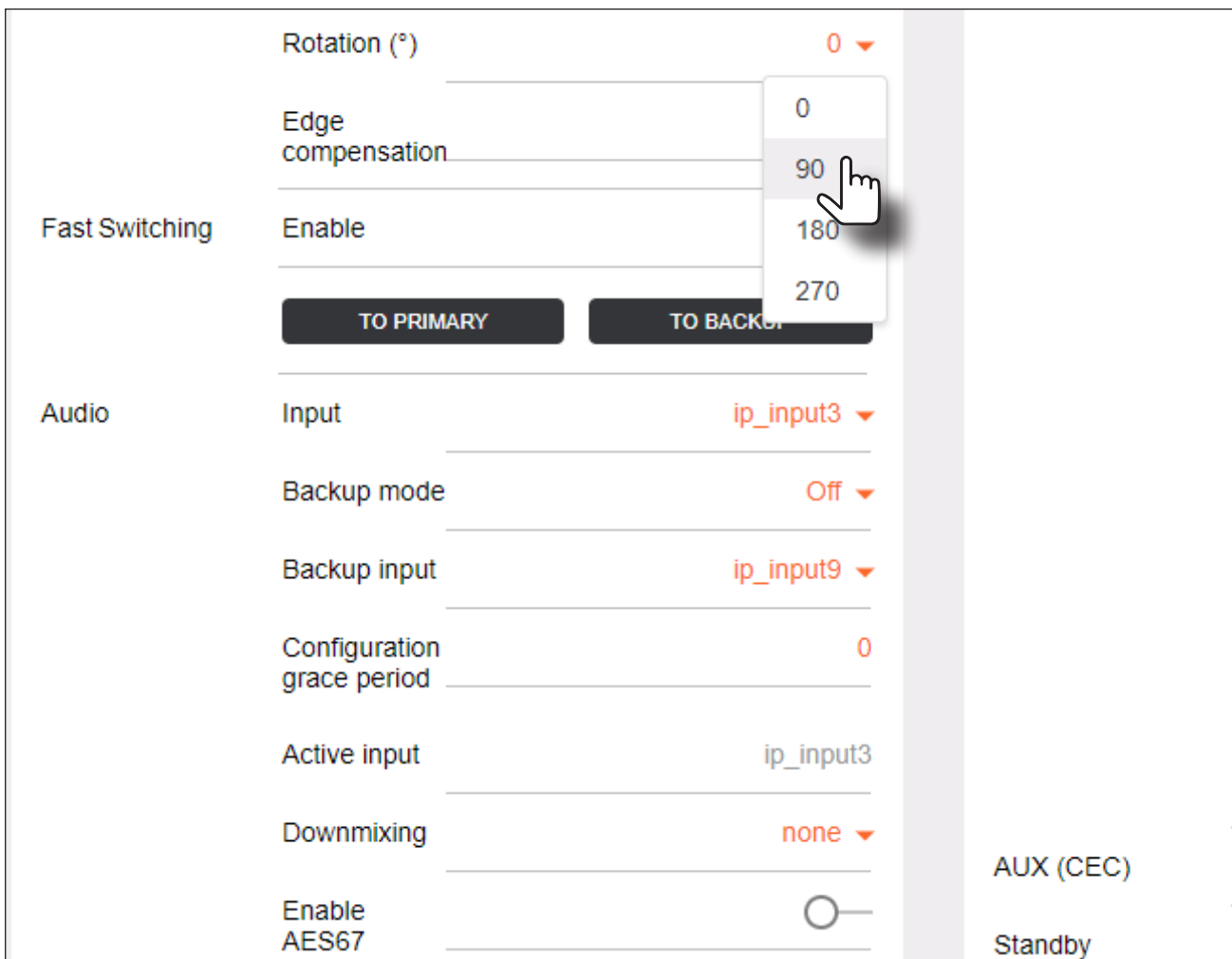

The image on Display 1 is cropped and rotated and is now displayed correctly. At this point, one-fourth of the video wall has been configured.

Figure 2.2: Portrait-mode 1 x 4 video wall with Display 1 properly oriented.

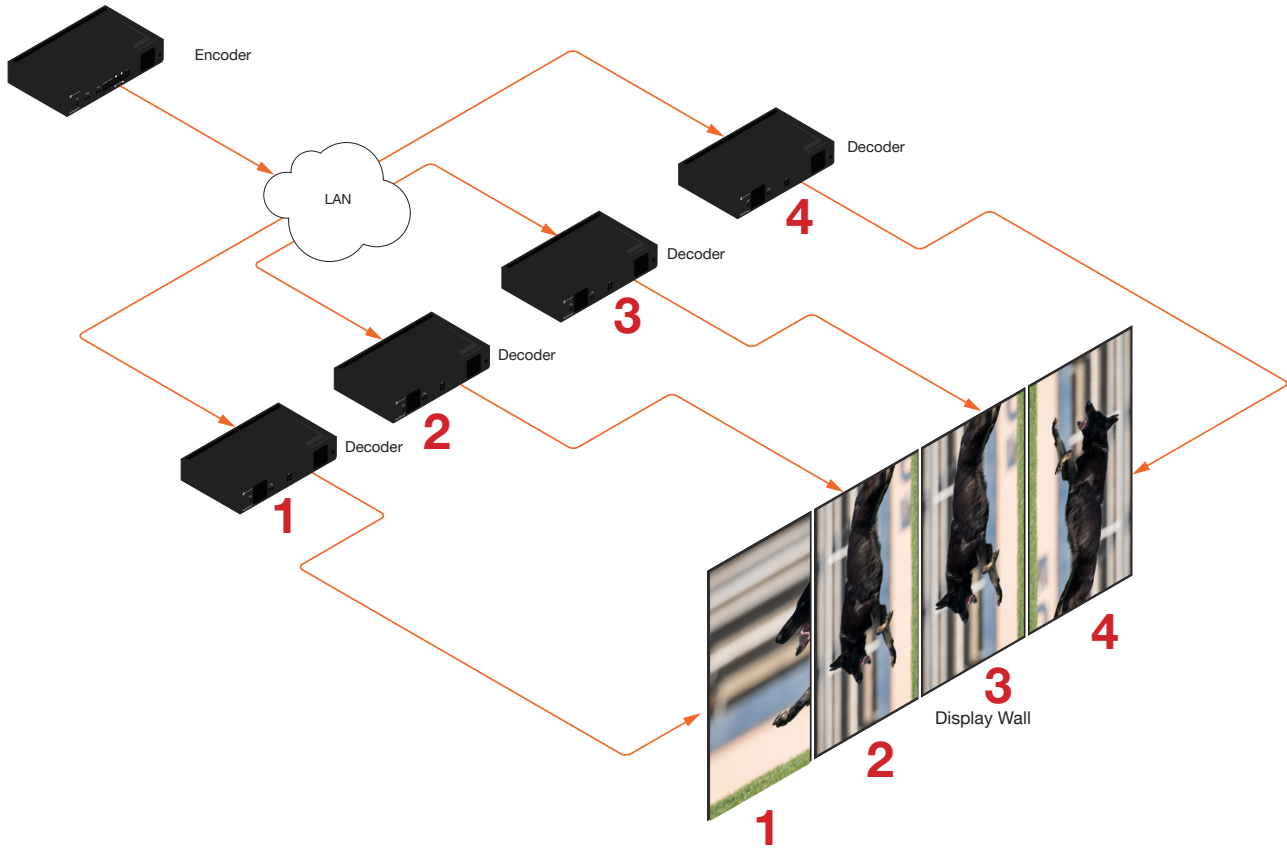

10. Click the **SAVE** button at the bottom of the screen to commit changes.
11. Repeat steps 3 through 9 for decoders 2, 3, and 4. Since display 2 and 3 were mounted upside-down, they will require a rotation of 180° (to flip horizontally) + 90° (to align them as portrait), giving a total rotation of 270°.

IMPORTANT: When using dual-channel decoders, the **Rotation** feature can only be used when a single HDMI channel is active. Image rotation is not supported on dual-channel decoders when both HDMI channels are active. Single-channel decoders do not have this restriction.

Once all four decoders have been properly configured, the image will be correctly displayed across all four displays. Refer to the illustration on the next page.

12. Check the image, on each display, and make sure they are aligned correctly with the other images on the video wall. Use the **Edge Compensation** drop-down list to adjust bevel compensation, if necessary. Refer to [Bezel Compensation \(page 86\)](#) for more information.

Figure 2.3: Portrait-mode 1 x 4 video wall displayed correctly.

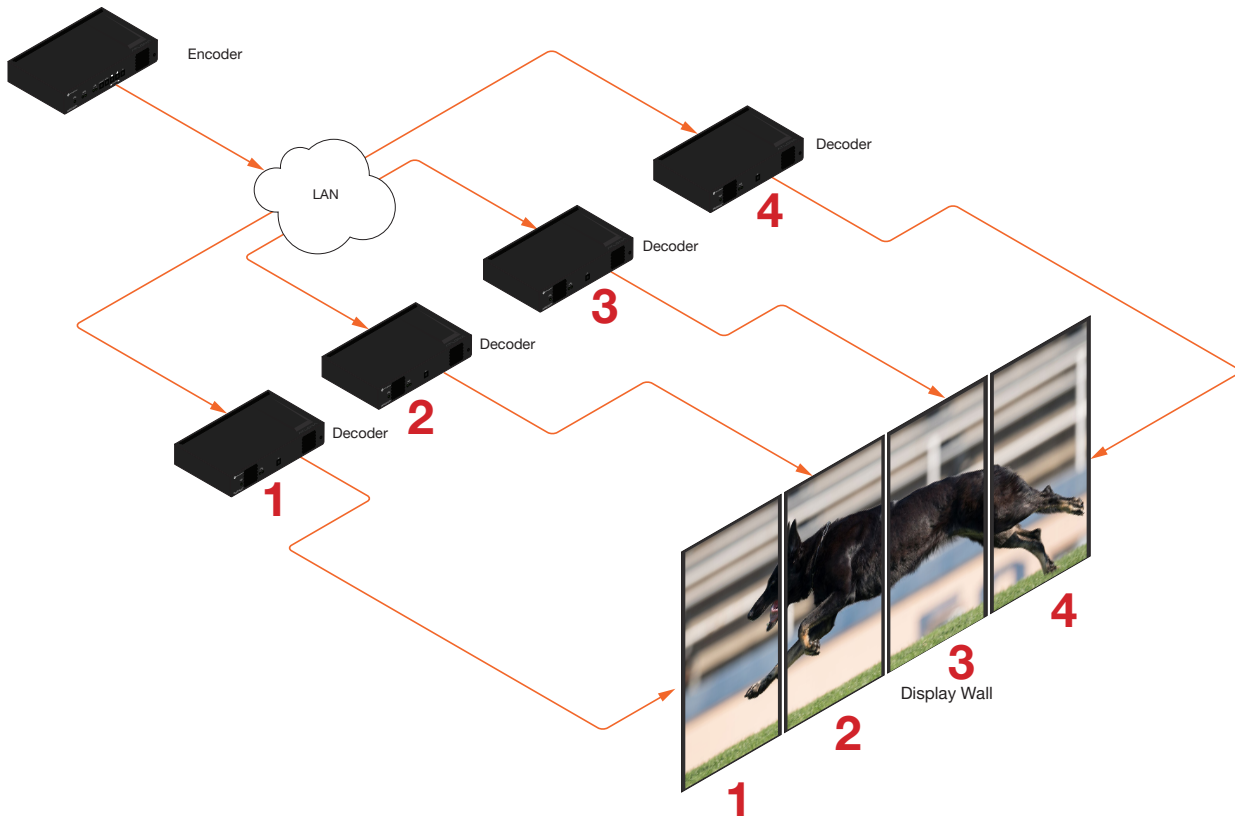

Bezel Compensation

Displays have a region where video is not displayed, called the bezel. This can cause display issues when creating video walls. Bezel compensation takes this area into account when a single video source is mapped across multiple displays. Bezel compensation can be adjusted at any time.

The illustration on the left shows a simple 2x2 video wall without bezel compensation. Note how the Atlona logo appears stretched, horizontally. On the right, bezel compensation is used to correct the image.

Image without bezel compensation



Image with bezel compensation applied



Bezel

1. Select **Bezel Compensation** from the **Edge Compensation** drop-down list.

Enable:	<input checked="" type="checkbox"/>
Unit:	Pixels
Display Width:	1920
Display Height:	1080
Horizontal:	0
Vertical:	0
Rotation (*):	0
Edge Compensation:	<div style="border: 1px solid #ccc; padding: 2px;"> None Bezel Compensation </div>
Fast Switching Enable:	<input type="checkbox"/>

2. Enter the **Top**, **Bottom**, **Left**, and **Right** values, as desired. Values can be entered in pixels, inches, or millimeters.
3. Click the **SAVE** button at the bottom of the screen to commit changes.

Video Walls using Velocity™

The following section provides instructions on creating and using video walls with the Atlona Velocity Control Software. Familiarity with the Velocity software is assumed. Refer to the *Atlona Velocity User Manual* for more information, if necessary.

NOTE: As of this writing, the Velocity™ software is limited to a maximum video wall size of 12 x 12, for resolutions of 4Kp30 and 1080p60.

1. Launch a web browser and enter the IP address of Velocity, in the address bar.
2. Enter the required login credentials.
3. Click the **Login** button.
4. The Velocity Dashboard will be displayed.
5. Click the ☰ icon, in the upper-left corner, to display the fly-out menu.

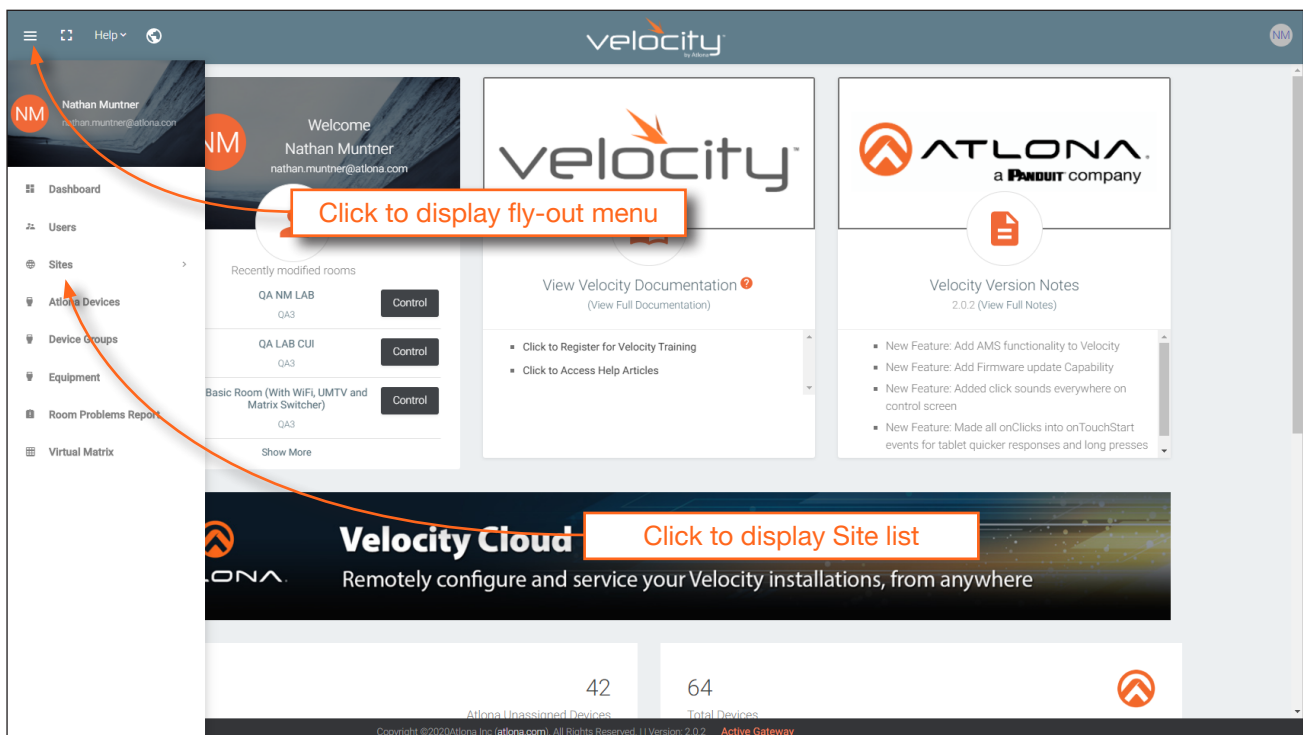

6. Click **Sites** in the menu bar to expand the list of buildings and rooms.
7. Click the desired room from the **Site** list.

NOTE: it is assumed that the selected room has already been populated with enough displays to construct a video wall, along with required number of OmniStream encoders and decoders. Refer to the Velocity User Manual for more information on adding displays and OmniStream units to a room.

- The **Modify Room** screen will be displayed. Click the **Add Technology** icon in the top far-right corner of the screen. This icon is represented by the + sign.

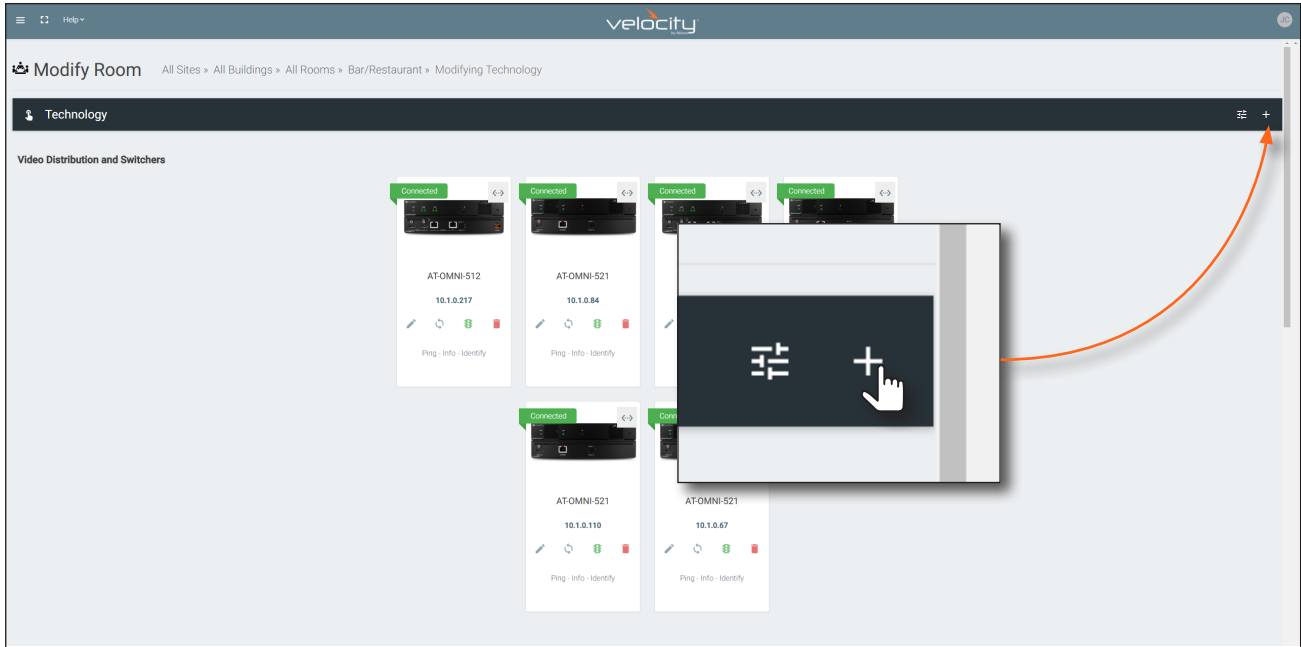

- The **Technology** fly-out menu will be displayed.
- Click **Miscellaneous > Atlona >** to expand the Atlona technology menu.
- Click the **Add** button for **Velocity Video Wall: VELOCITY-VIDEO-WALL**. The video wall technology will be added to the room.

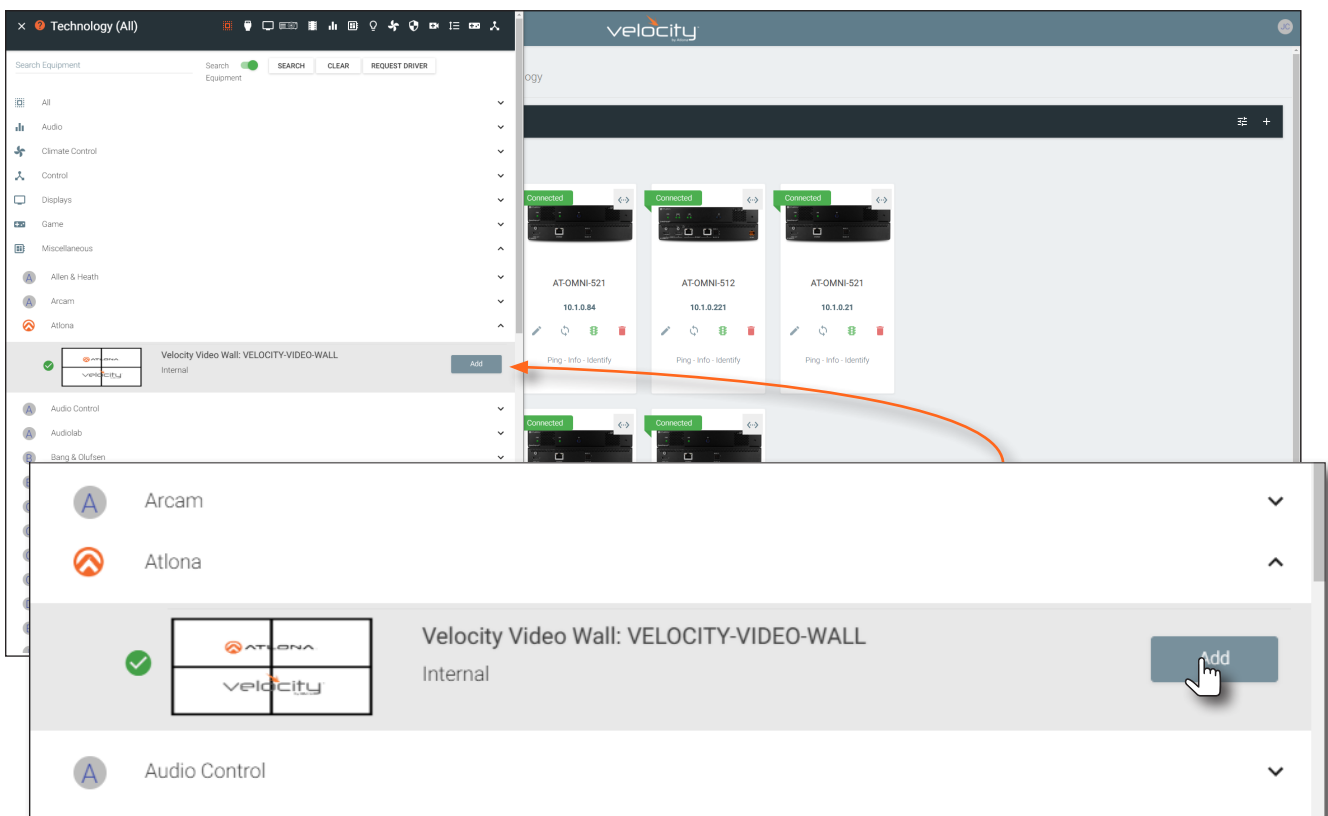

12. Scroll down to the bottom of the page and locate the **Velocity Video Wall** driver.
13. Click the **Edit** icon. This icon is represented by a pencil.

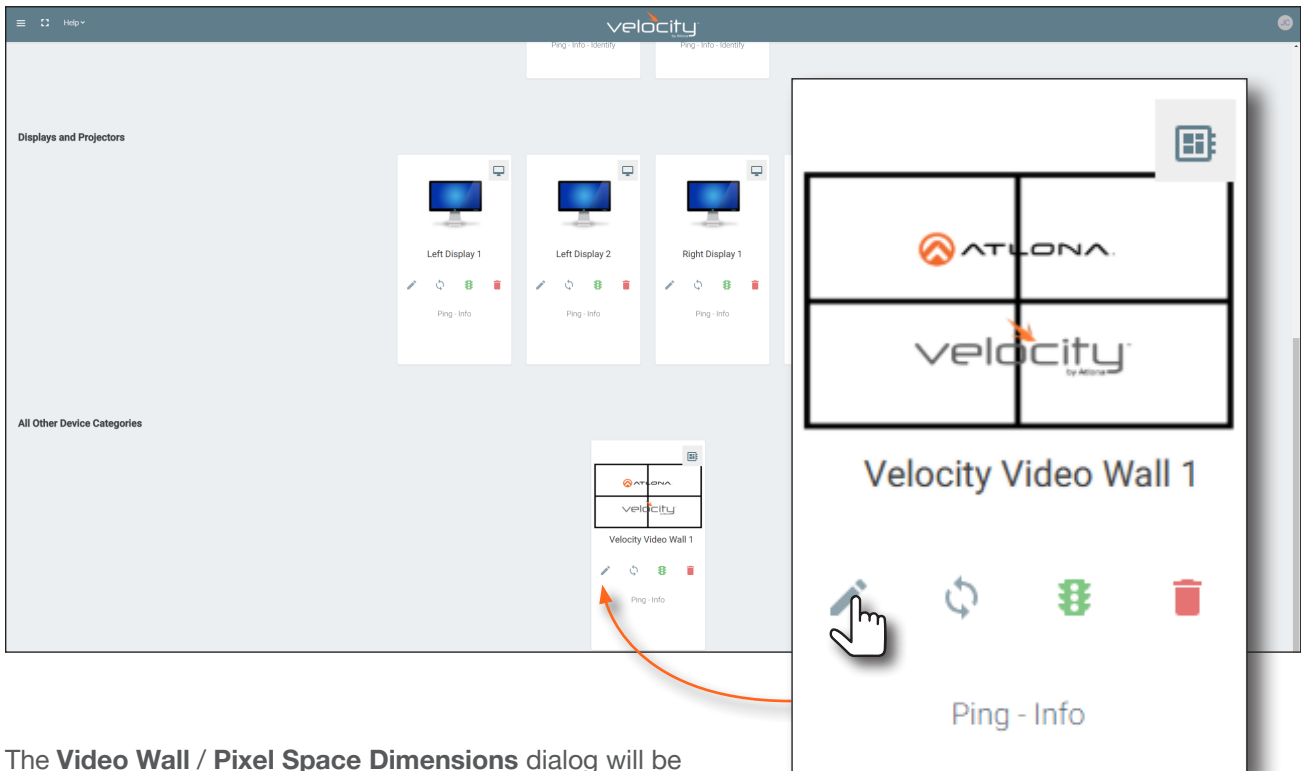

14. The **Video Wall / Pixel Space Dimensions** dialog will be displayed. This dialog will automatically be displayed when the video wall driver is edited for the first time.

The default video wall dimensions are set to 3840 x 2160. To modify the video wall size, follow steps 14a through 14e. To continue with the default video wall dimensions, click the **CLOSE** button and go to step 15.

- a. Click the **Lock Pixel Space** toggle switch to disable it. When disabled, the toggle switch will turn gray.
- b. Under **Pixel Space Dimensions**, click the drop-down list to select the desired video wall dimensions.

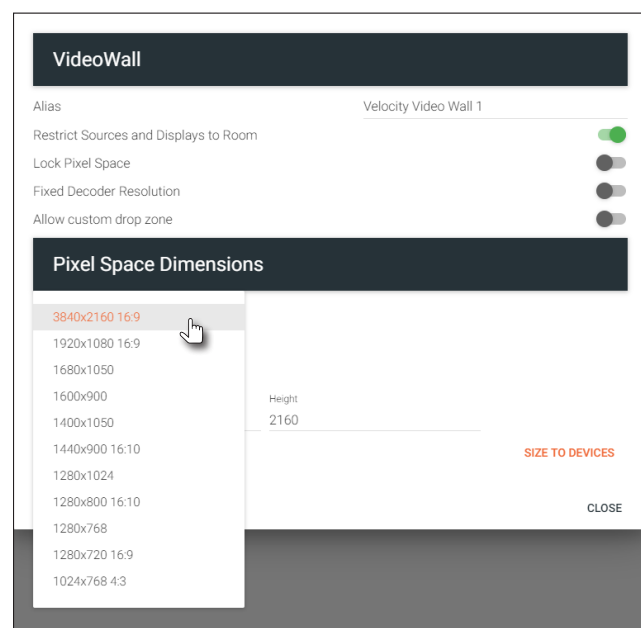
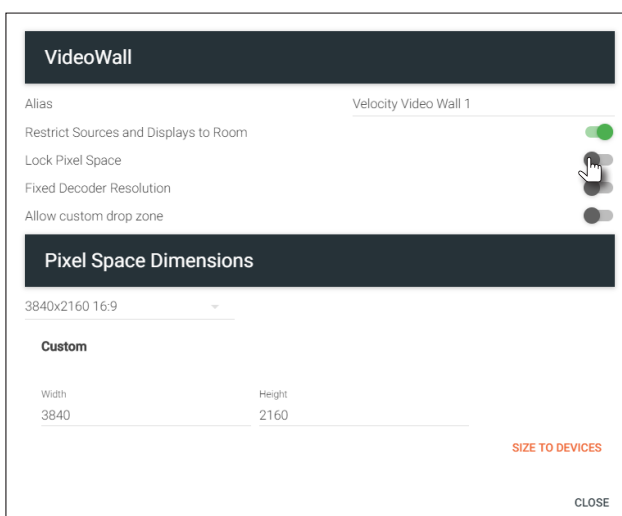

- c. To create a custom size for the video wall, enter the desired dimensions under the **Custom** section. Enter the width and height directly, or use the spinner controls at the far end of each field, to adjust the values.
- d. Save the video wall dimensions by clicking the **Lock Pixel Space** toggle switch to enable it.
- e. Click the **CLOSE** button to dismiss the dialog.

Before continuing, refer to the **Pixel Space** tool bar at the top of the screen. The following identifies each icon:

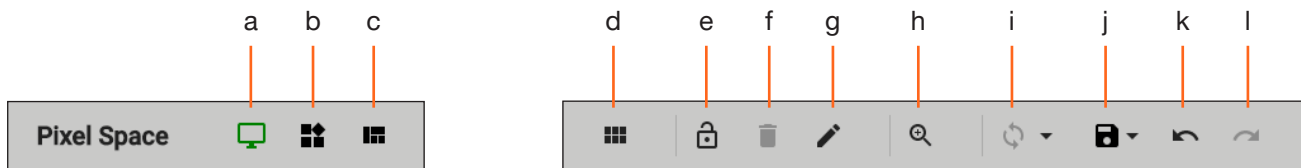

- a. **Displays**
Click to icon to show the Displays window on the left side of the screen. In this mode, displays can be edited.
- b. **Presets**
Click this icon to display the Presets window on the left side of the screen. In this mode, presets can be edited, added, or deleted.
- c. **Drop Zones**
Click this icon to display the Drop Zones window on the left side of the screen. Refer to [Creating and Using Drop Zones \(page 100\)](#) for more information.
- d. **Auto Arrange**
Click this icon to auto-arrange the number of displays in the **Pixel Space** window into the selected number of rows and columns.
- e. **Lock**
When locked, this icon will turn red, and prevent accidental repositioning of displays or changing presets. To unlock the displays (for adjustment purposes), click this icon again.
- f. **Delete All**
Click this icon to delete all displays within the **Pixel Space** window. This icon will only be available if displays are present in the **Pixel Space** window. This icon is only enabled if displays have been added to the Pixel Space window.
- g. **Pixel Space**
Click this icon to display the **VideoWall** dialog box, allowing modification of both the Video Wall and Pixel Space settings.
- h. **Zoom**
Click this icon to display the zoom fly-out slider control. Click and drag the slider to adjust the zoom factor of the **Pixel Space** window.
- i. **Apply Preset**
Click this icon to apply the current preset. Click the down arrow next to this icon to display the Apply Preset fly-out menu. This control defines when Velocity automatically applies a preset: 1) Auto apply preset on save; 2) Auto apply preset on source change.
- j. **Save**
Click this icon to save the current layout/settings. Click the down-arrow, next to this icon, to display the Save fly-out menu option, allows enabling or disabling of auto-saving.
- k. **Undo**
Click this icon to undo the last operation.
- l. **Redo**
Click this icon to redo the last operation. Clicking this icon after an undo operation will restore the previous setting.

- Under the **Displays** window, on the left side of the screen, drag and drop the desired displays to the **Pixel Space** window.

Alternatively, to add all displays to the **Pixel Space** windows without manually using drag-and-drop, click **ADD REMAINING**, at the bottom of the Displays window. This will automatically populate the **Pixel Space** window with all available displays. Note that if all displays have been dragged to the **Pixel Space** window, then this option will be grayed out. In this example, four displays are being added, manually.

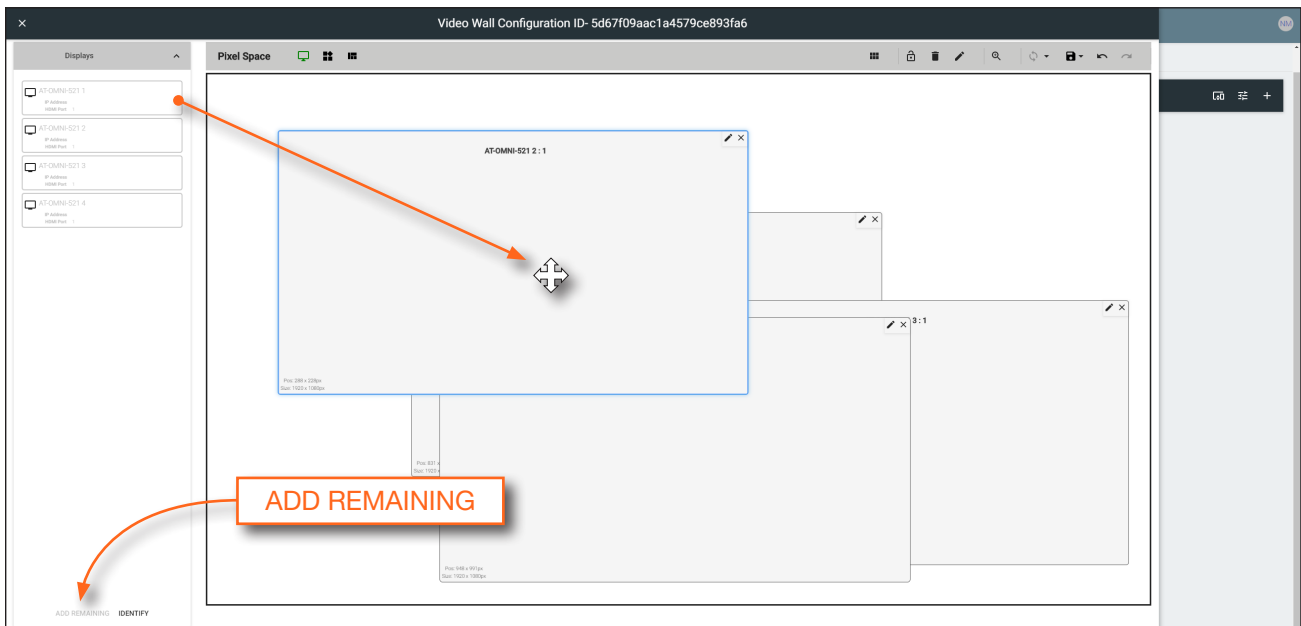

NOTE: The order in which the displays are placed in the **Pixel Space** window is not important and both the number of displays and how they are arranged can always be changed at a later time.

- Click the **Auto Arrange** icon in menu bar at the top of the **Pixel Space** window. Move the mouse within the **Auto Arrange** pop-up dialog to adjust the size of the video wall. Click the lower right-most blue square of the video wall to commit the selection. In this example, a 2x2 video wall will be created.

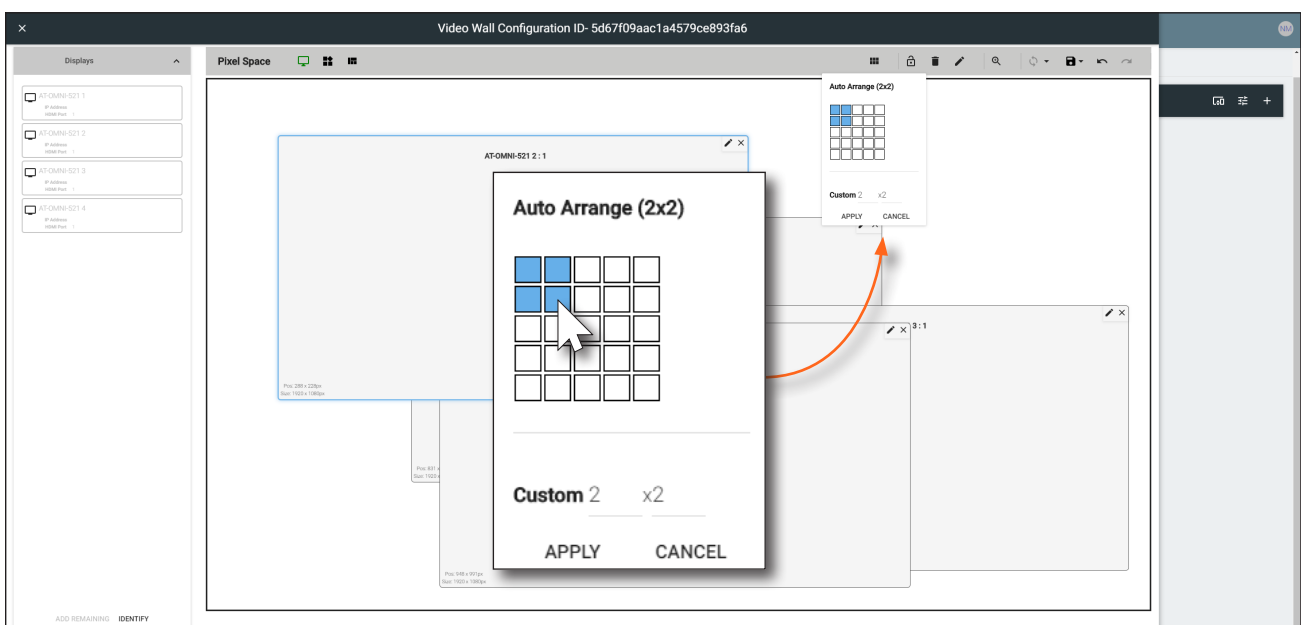

Landscape Orientation

If any displays have been mounted upside-down, the orientation can be corrected, without having to remount the displays in the correct orientation. Refer to [Landscape Mode \(page 74\)](#) for an example walkthrough of how rotation is used in video walls within OmniStream.

- a. Click the **Edit** icon (pencil icon) in the upper-right corner of the display that requires adjustment.

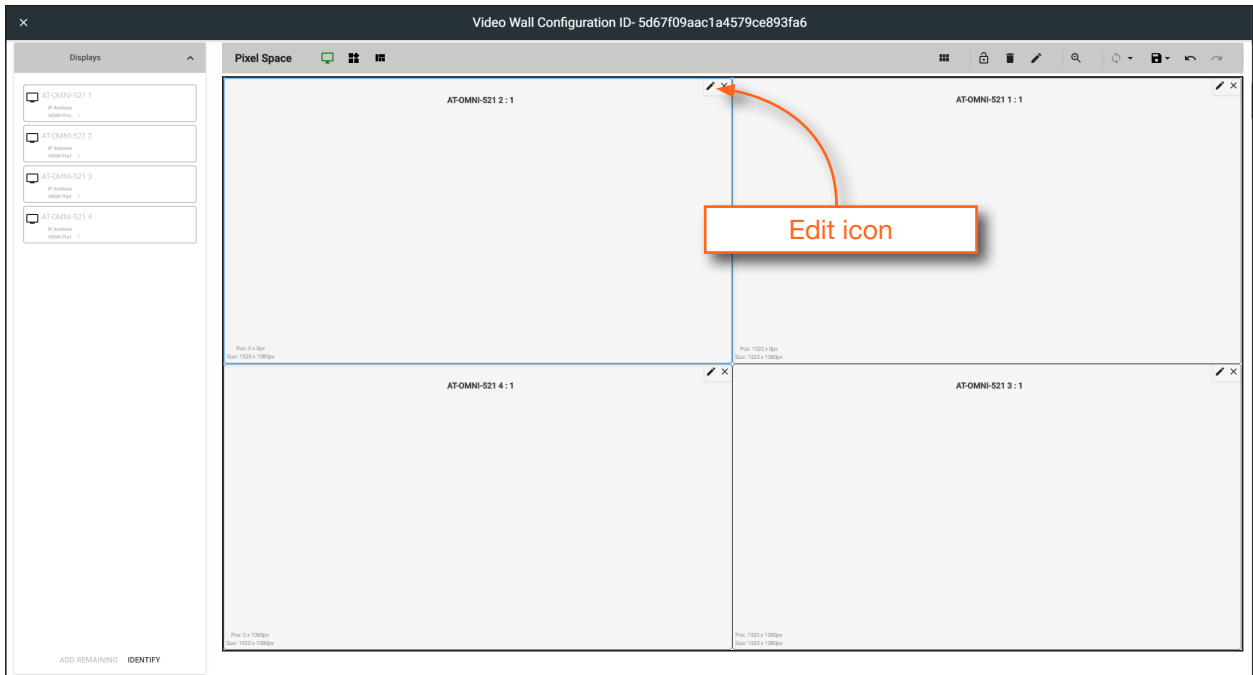

- b. The dialog for the selected decoder will be displayed.
- c. Click the Rotation drop-down list and select the desired rotation. If the image on the display is upside-down, select **180 degrees**.
- d. Click the **CLOSE** button to commit changes.

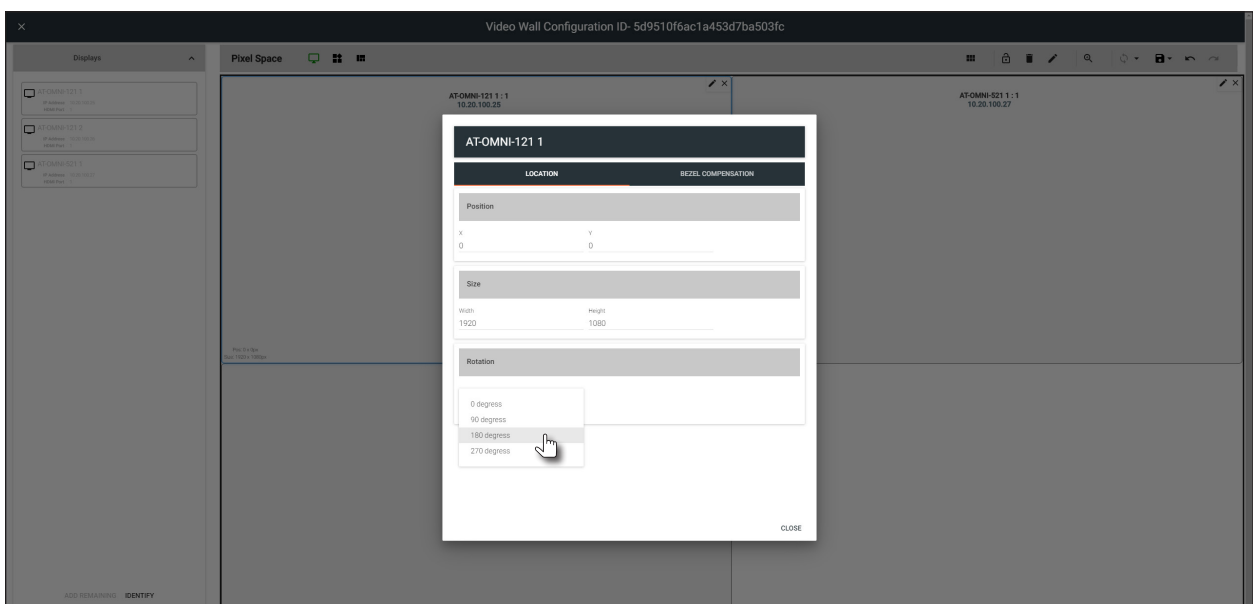

Portrait Orientation

IMPORTANT: Portrait Mode is only supported on single-channel decoders.

If any displays have been mounted upside-down, the orientation can be corrected, without having to remount the displays in the correct orientation. Refer to [Portrait Mode \(page 80\)](#) for an example walkthrough of how rotation is used in video walls within OmniStream. The illustration below shows 3x1 video wall, created using the **Auto Arrange** icon (inset image).

- a. Click the **Edit** icon (pencil icon) in the upper-right corner of the display that requires adjustment.

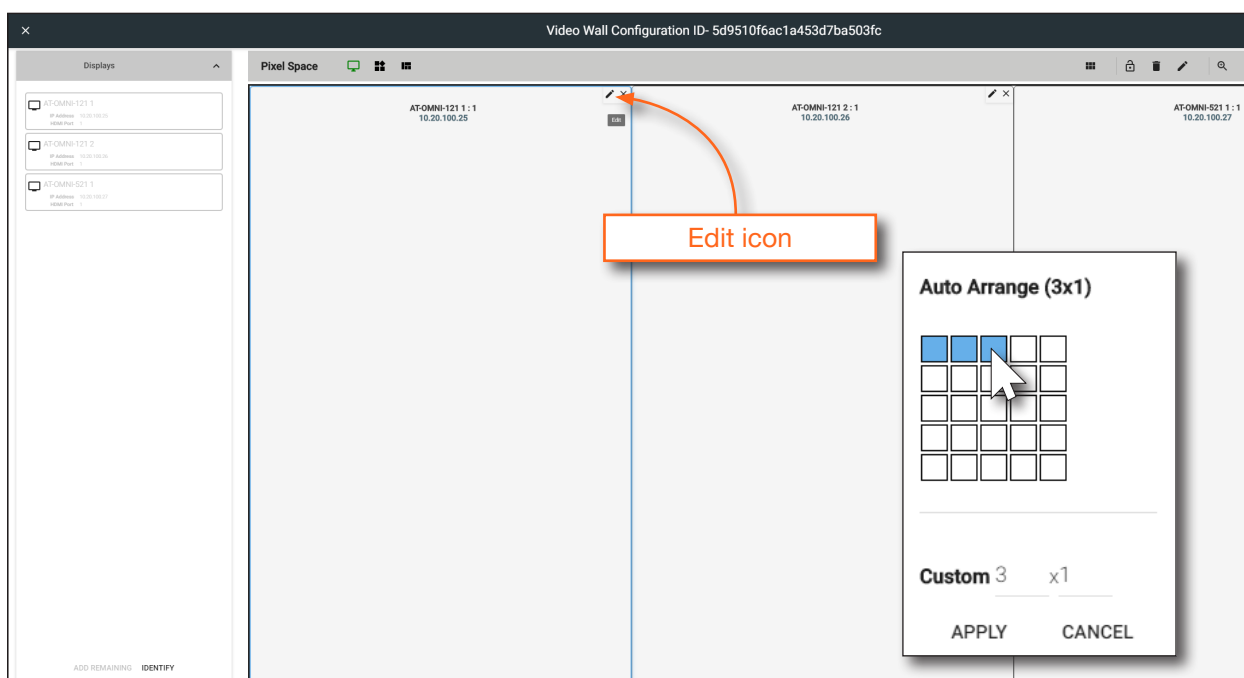

- b. The dialog for the selected decoder will be displayed.
- c. Click the Rotation drop-down list and select the desired rotation. If the image needs to be rotated from landscape to portrait, select **90 degrees**. If the display is mounted upside-down AND requires rotation from landscape to portrait, select **270 degrees**.
- d. Click the **CLOSE** button to commit changes.

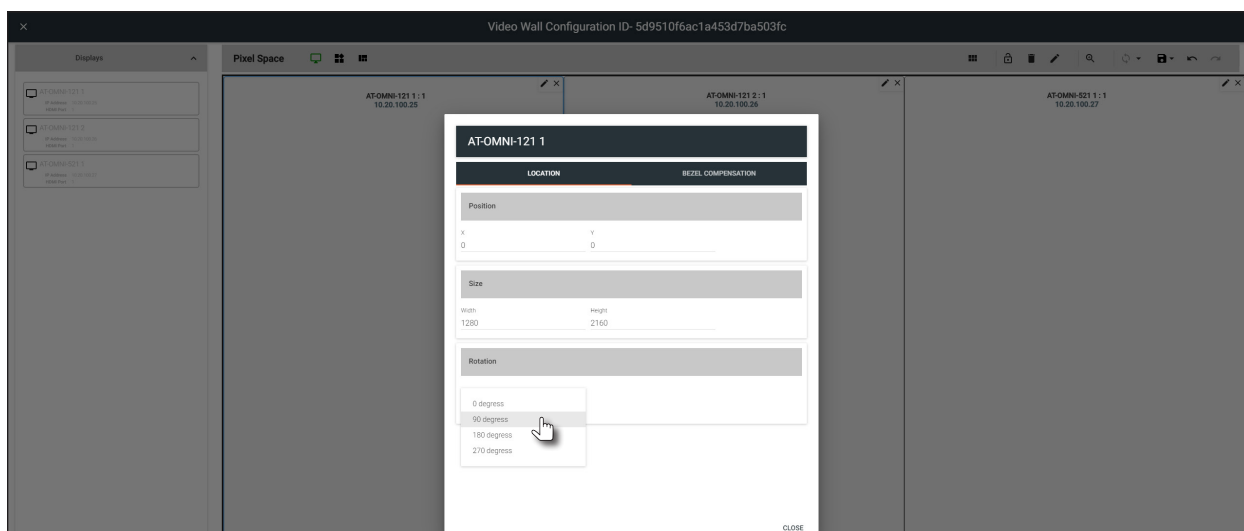

Once **Auto Arrange** has been applied, the **Pixel Space** window will appear similar to the illustration below. It should be noted that each display can be rearranged if necessary. To reposition displays, click and drag them to the appropriate places, within the **Pixel Space** window. Note that each display is identified with a name and an IP address, in the upper-left corner. Refer to the *Atlona Velocity User Manual* for more information on naming devices.

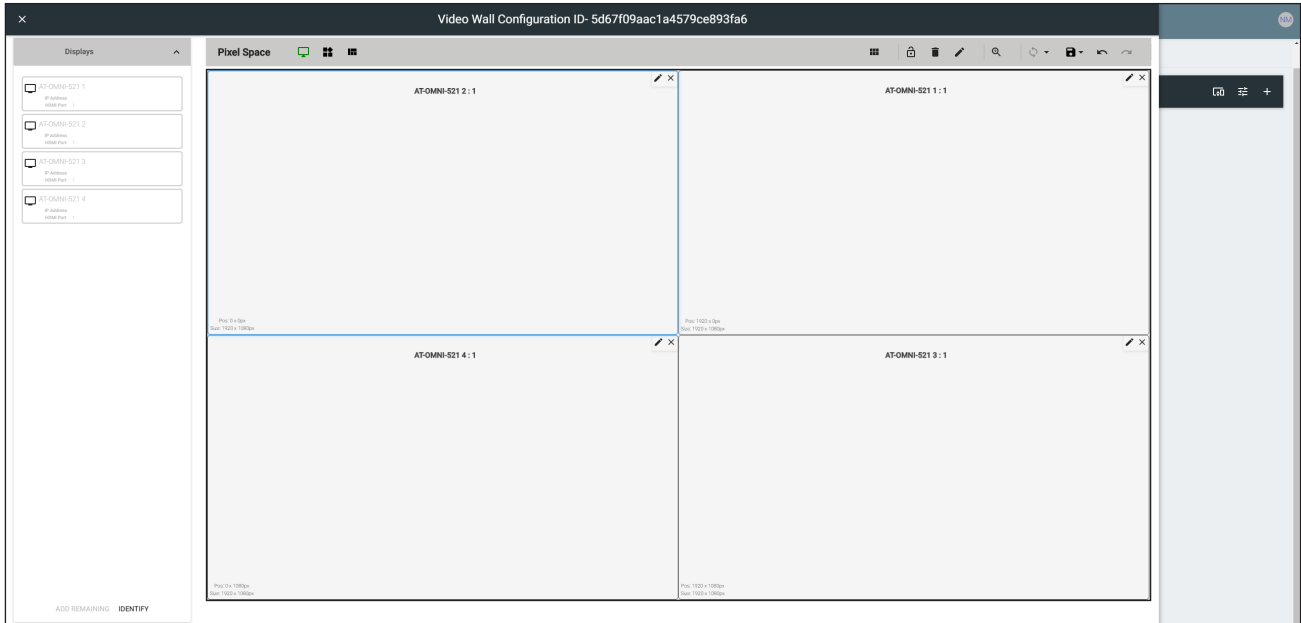

17. Click the **Lock Displays** icon in the menu bar of the **Pixel Space** window. This is optional. However, enabling this feature will prevent accidental repositioning of the displays, during the configuration procedure. When locked, this icon will turn red. Both the **Trash** and **Auto Arrange** icons will be disabled. To unlock the displays (for adjustment purposes), click the **Lock Displays** icon again.

18. Click the **Save** icon in the upper-right corner of the **Pixel Space** window. This will save the current layout.

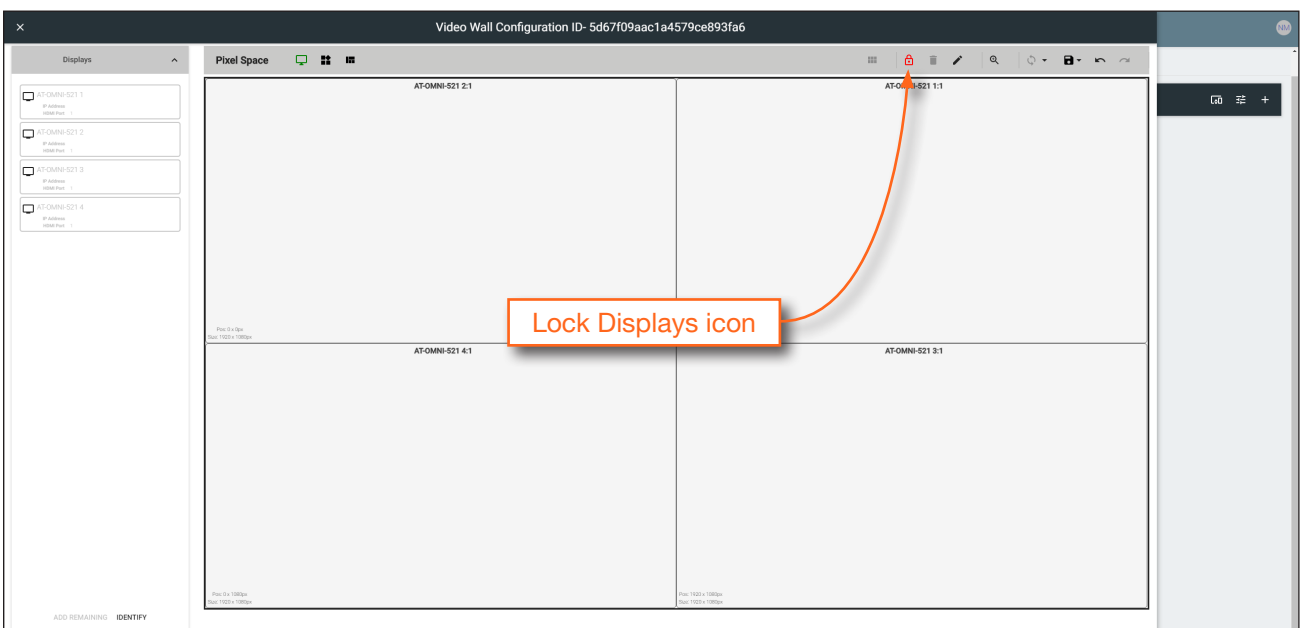

Creating Presets

Presets are used to save window layouts, within the **Pixel Space** window. Once a preset is created it can be recalled at any time.

1. Click the **Presets** icon. When clicked, this icon will turn green and the Presets window will be displayed on the left side of the screen.

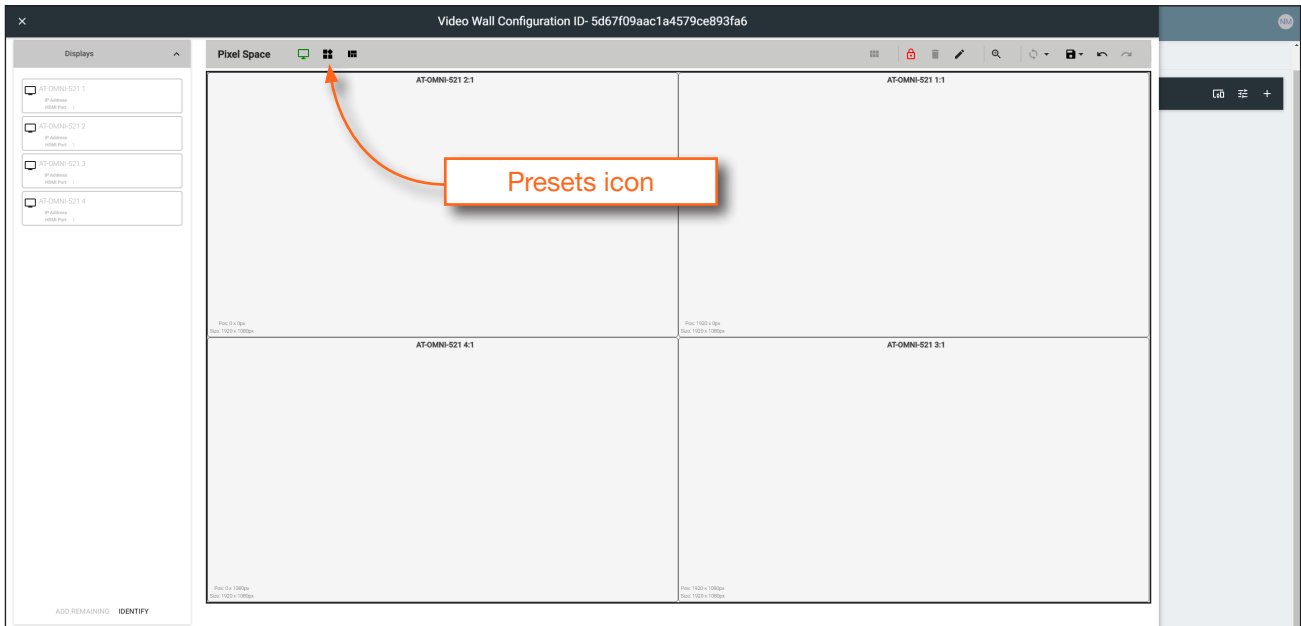

2. Click **Add**, under **Presets**.

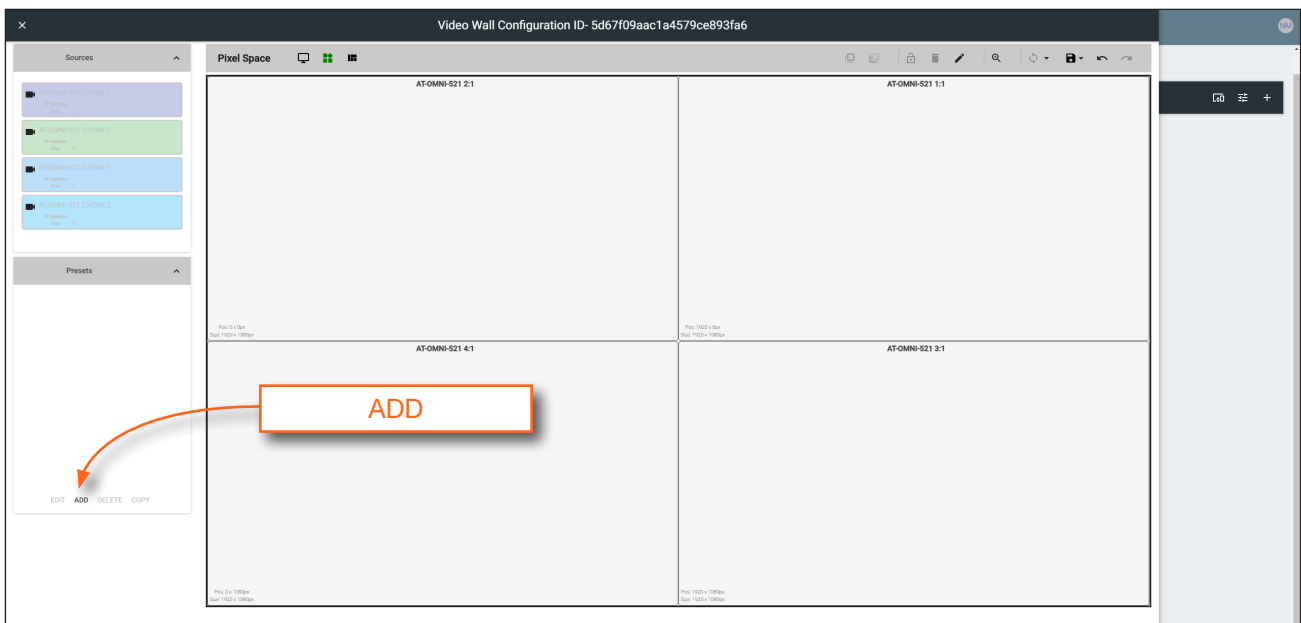

3. Enter the name of the preset in the **Preset Edit** dialog, then click CLOSE to save the preset name and dismiss the dialog.



4. Under the **Sources** window, on the left side of the screen, drag and drop the desired source(s) to each display in the **Pixel Space** window. Note that the same source can be mapped to other displays. For example, in the illustration below, both the display in the upper-left corner and lower-right corner share the same source.

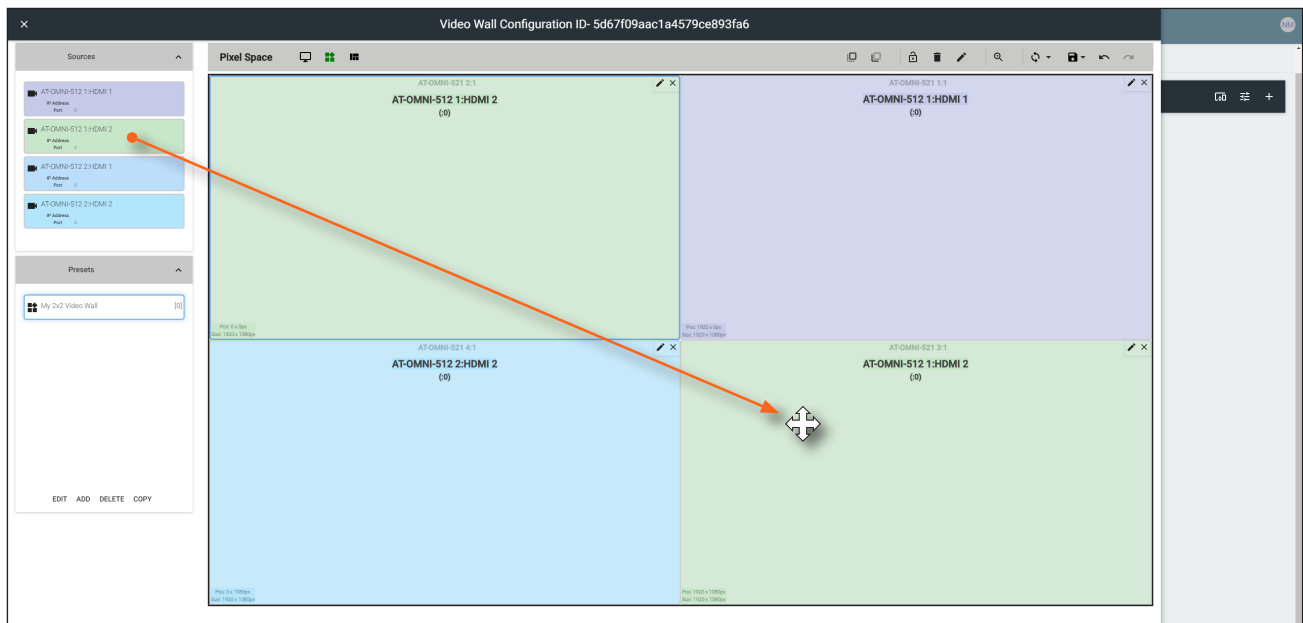

Sources can also be re-sized “on the fly” to achieve the desired presentation. To re-size a source, click and drag the source window horizontally, vertically, or diagonally. Release the mouse to commit the changes. Refer to the *Atlona Velocity User Manual* for more information on manipulating source windows.



NOTE: When source windows are resized, they will “snap” to the nearest vertical or horizontal border, depending upon the direction that the mouse cursor is being moved. Source windows cannot occupy fractions of a display window.

Preset Orientation

There may be some situations in which content that is spread across multiple displays must be rotated. Two examples are shown below.

Example 1: Content requiring rotation.

In the following example, a single source is spread across three vertical displays. The source content (shown on the left) is rotated -90 degrees. In order for the content to be displayed correctly, the source must be rotated.

Figure 1.1 - Source content



Figure 1.2 - Source content properly rotated to span three vertically rotated displays.

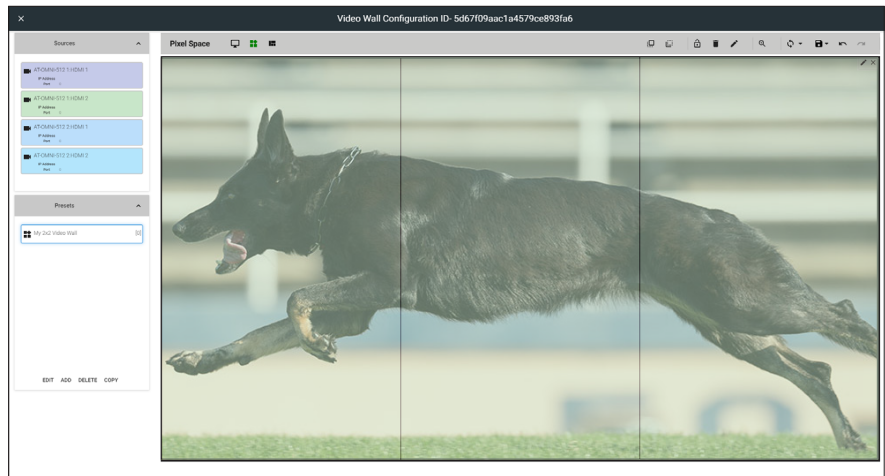

1. Click the  icon in the upper-right corner of the screen. The source dialog will be displayed.
2. Locate the **Disable Rotation** toggle switch at the bottom of the dialog.
3. Verify that the toggle switch is set to the far-left position. The toggle switch will be gray when rotation is *enabled*.
4. Click **CLOSE** to commit changes and dismiss the dialog box.

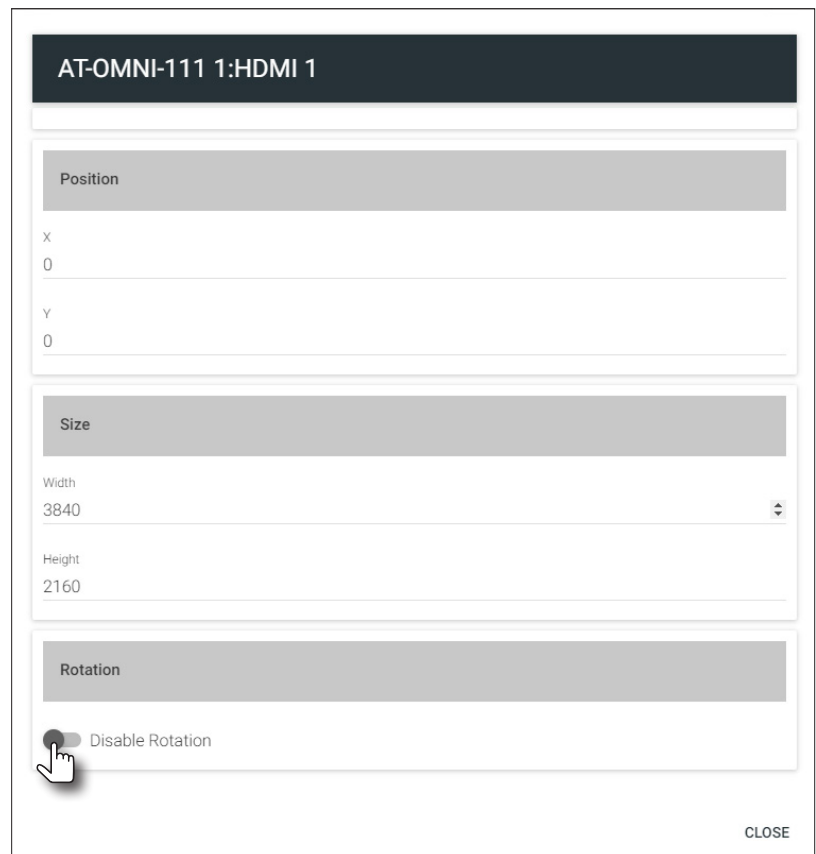

Example 2: Content that does not require rotation.

In this example, three sources are spread across three vertical displays. The content (shown on the left) was created to be displayed horizontally. In this case, rotating the source is not required.

Figure 1.1 - Source content

Source 1

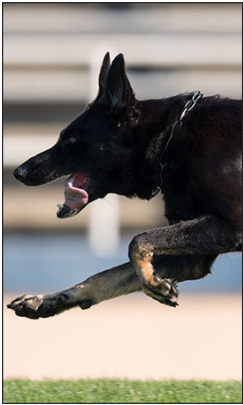

Source 2

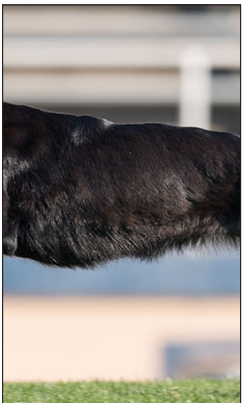

Source 3

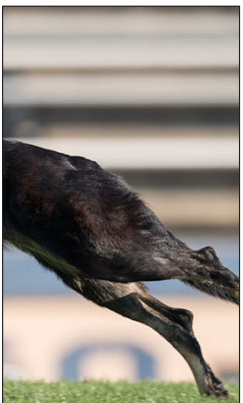
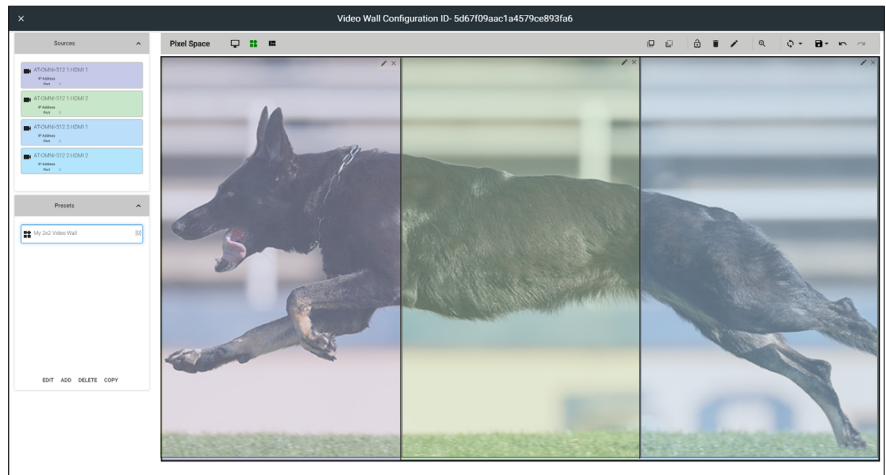

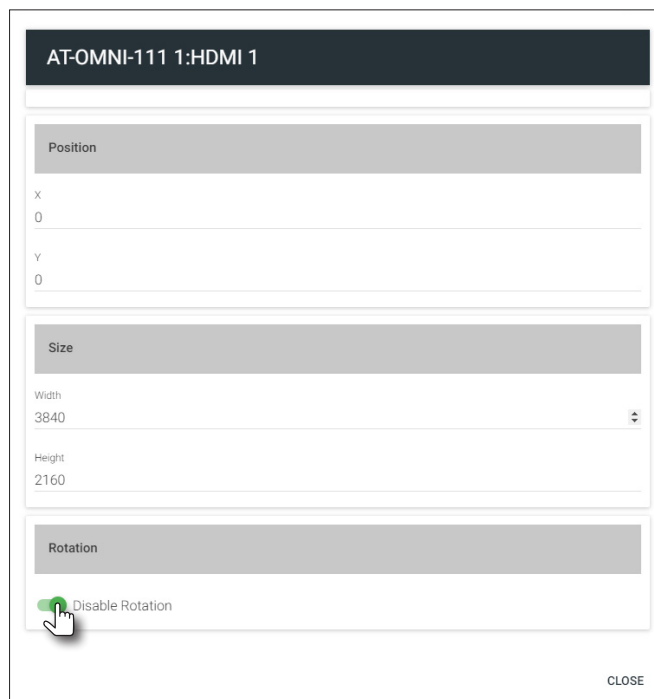
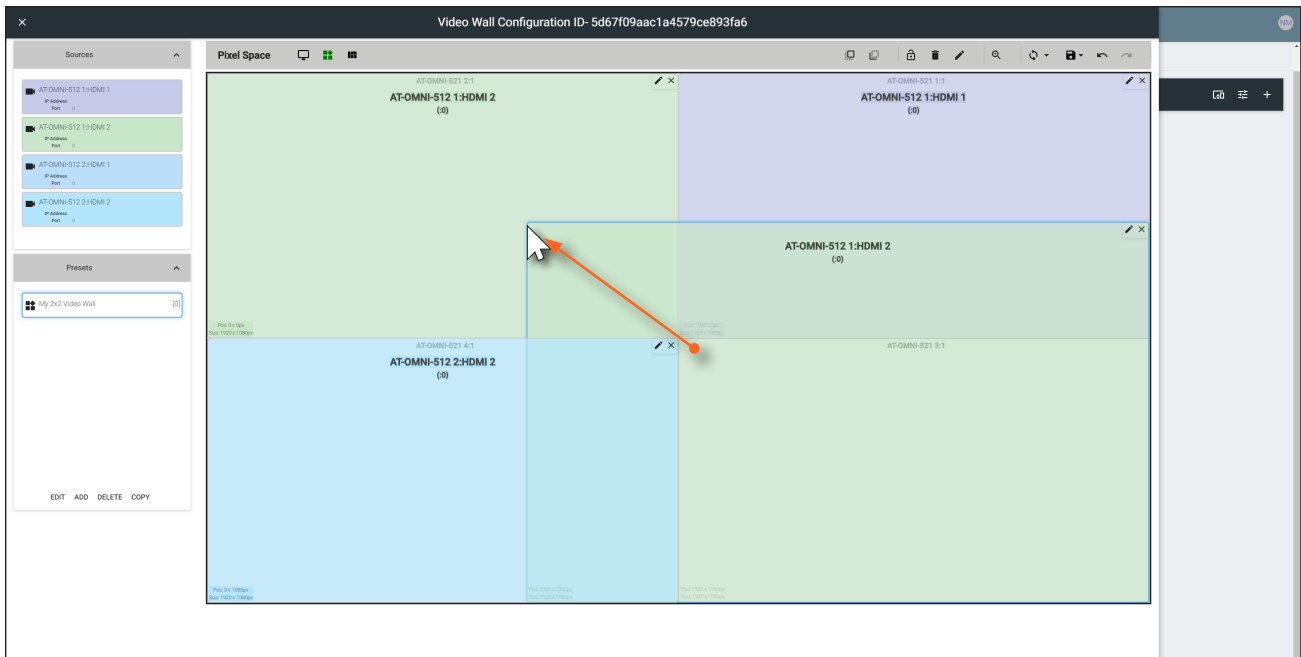

Figure 1.2 - Source content properly rotated to span three vertically rotated displays.



1. Click the  icon in the upper-right corner of the source window. The source dialog will be displayed.
2. Locate the **Disable Rotation** toggle switch at the bottom of the dialog.
3. Verify that the toggle switch is set to the far-left position. The toggle switch will be green when rotation is *disabled*.
4. Click **CLOSE** to commit changes and dismiss the dialog box.
5. Repeat steps 1 through 4 for each source.





- Repeat steps 2 through 4 to create additional presets. Once the desired presets have been created, click the preset name to recall it. The video wall will be updated with the selected preset.

Refer to the *Atlona Velocity User Manual* for more information on using and recalling presets.

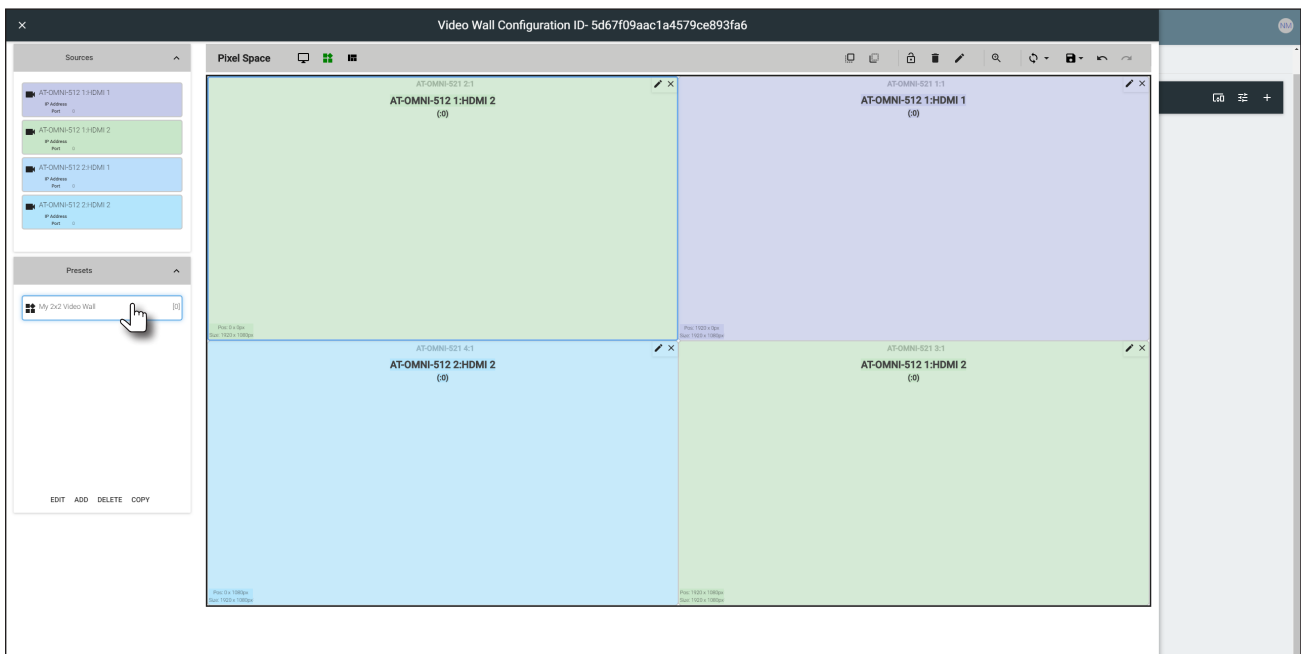

Creating and Using Drop Zones

Drop Zones are “containers”, allowing sources to be placed (“dropped”) in real-time on a video wall. Drop Zones are similar to presets except that, unlike presets, Drop Zone content can be changed on-the-fly within the Video Wall Control Screen.

1. Populate the **Pixel Space** window with the desired devices.
2. Click the **Lock Displays** icon to lock the devices in place.
3. Click the **Drop Zones** icon in the **Pixel Space** menu bar.
4. Click **ADD**, under the **Drop Zones** window, on the left side of the screen. This will create the Drop Zone *preset*.

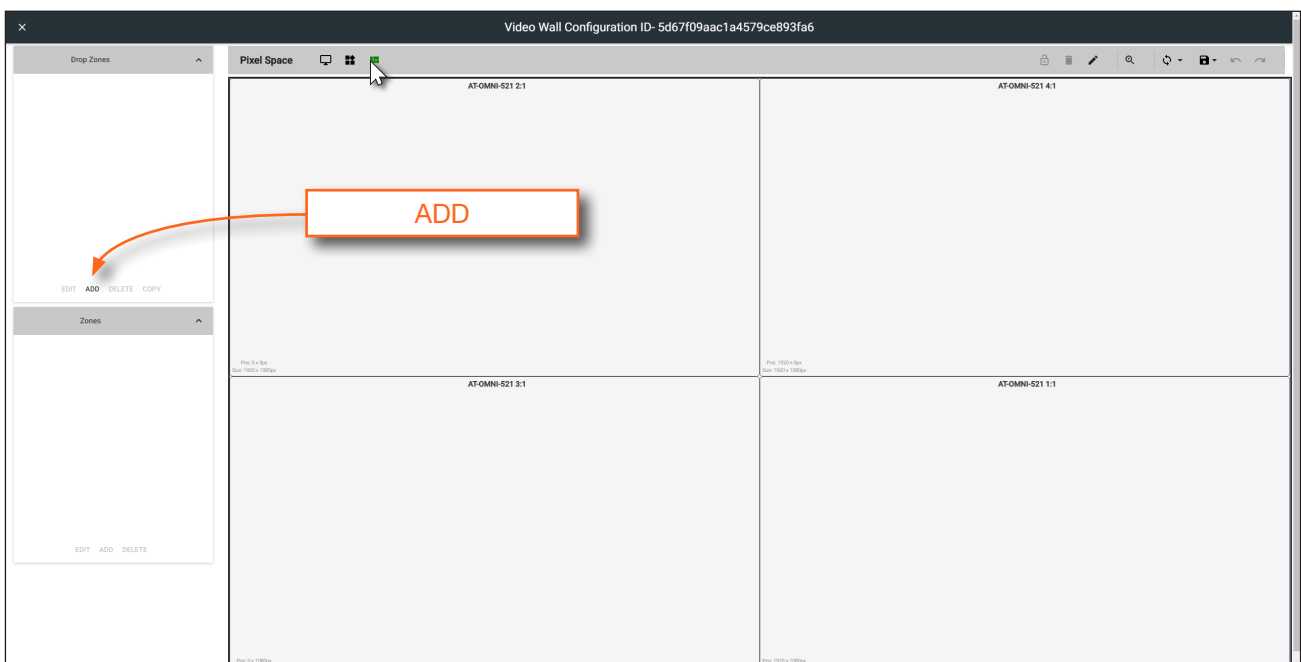

5. Click **EDIT** and provide a name for the Drop Zone in the **Drop Zone Edit** dialog box.
6. Click the **CLOSE** button to commit the change.

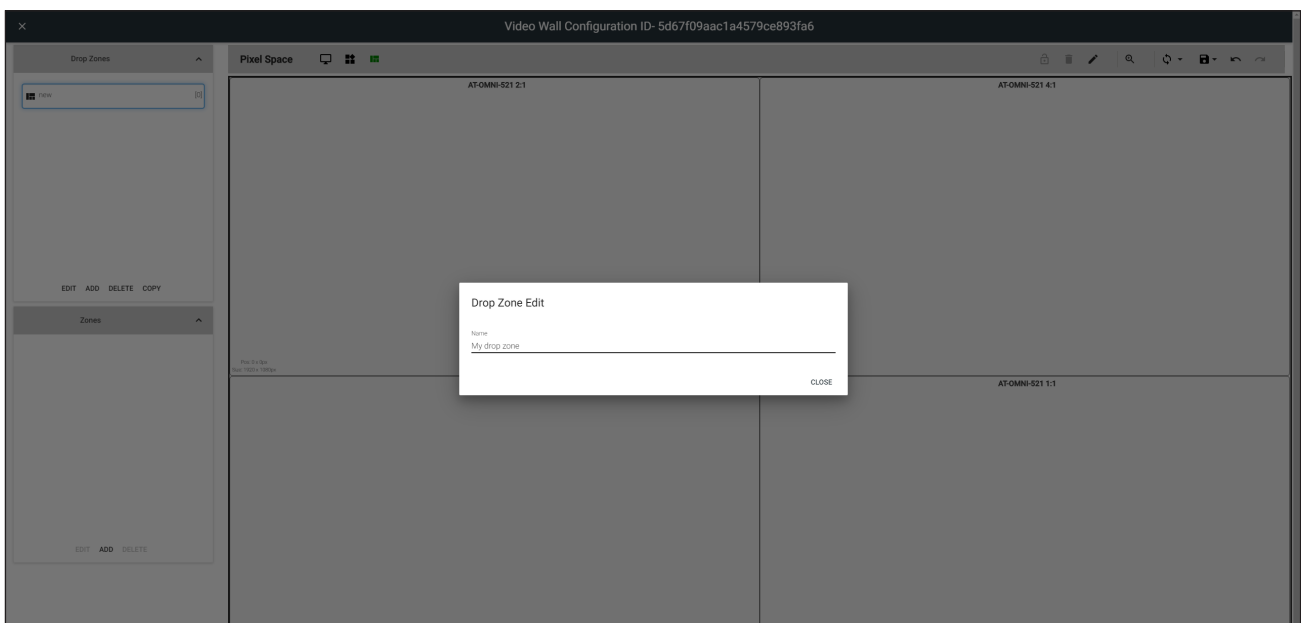

Preset Orientation

There may be some situations in which content that is spread across multiple displays must be rotated. Two examples are shown below.

Example 1: Content requiring rotation.

In the following example, a single source is spread across three vertical displays. The source content (shown on the left) is rotated -90 degrees. In order for the content to be displayed correctly, the source must be rotated.

Figure 1.1 - Source content

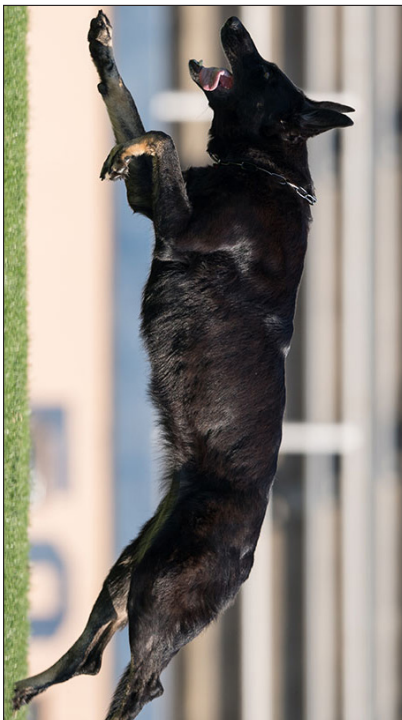
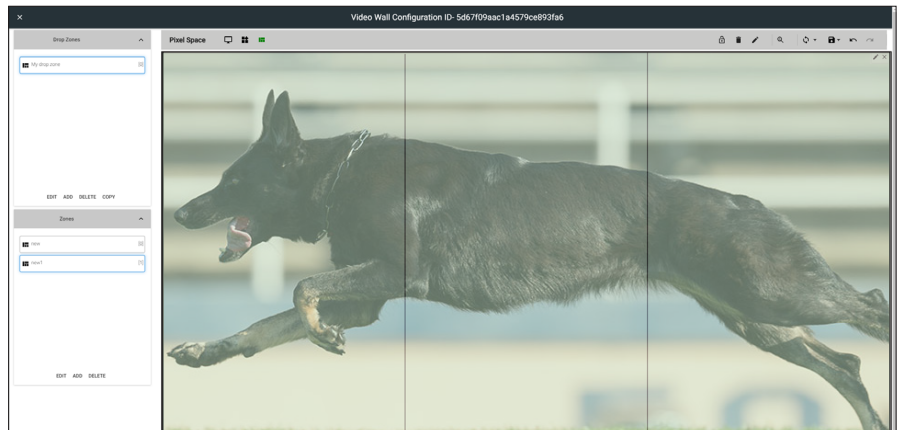



Figure 1.2 - Source content properly rotated to span three vertically rotated displays.



1. Click the  icon in the upper-right corner of the screen. The **Edit Zone** dialog will be displayed.
2. Locate the **Disable Rotation** toggle switch at the bottom of the dialog.
3. Verify that the toggle switch is set to the far-left position. The toggle switch will be gray when rotation is *enabled*.
4. Click **CLOSE** to commit changes and dismiss the dialog box.

Edit Zone

Name

Position

X
0

Y
0

Size

Width
3840

Height
2160

Rotation

Disable Rotation

Example 2: Content that does not require rotation.

In this example, three sources are spread across three vertical displays. The content (shown on the left) was created to be displayed horizontally. In this case, rotating the source is not required.

Figure 1.1 - Source content

Source 1

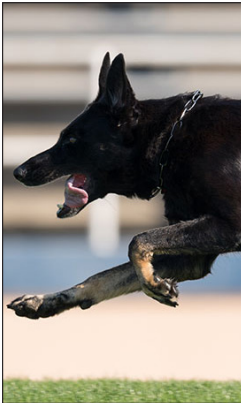

Source 2

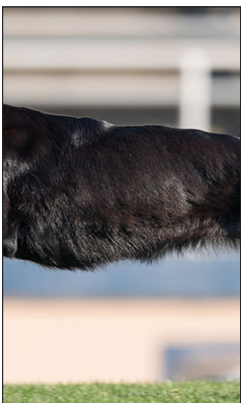

Source 3

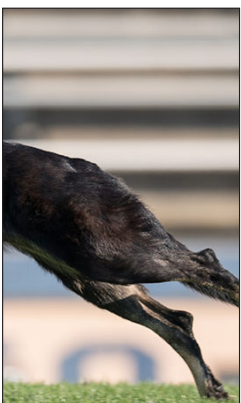
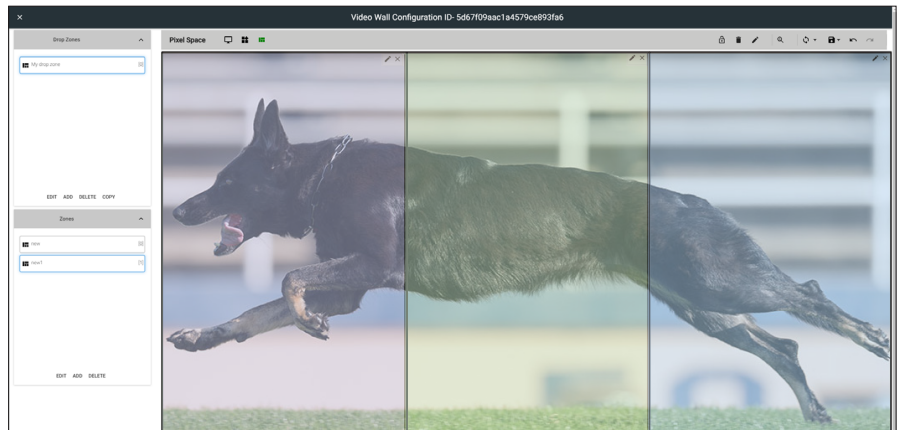



Figure 1.2 - Source content properly rotated to span three vertically rotated displays.



1. Click the  icon in the upper-right corner of the source window. The **Edit Zone** dialog will be displayed.
2. Locate the **Disable Rotation** toggle switch at the bottom of the dialog.
3. Verify that the toggle switch is set to the far-left position. The toggle switch will be green when rotation is *disabled*.
4. Click **CLOSE** to commit changes and dismiss the dialog box.
5. Repeat steps 1 through 4 for each source.

Edit Zone

Name
hew

Position

X
0

Y
0

Size

Width
3840

Height
2160

Rotation

 Disable Rotation

7. Click **ADD**, under the **Zones** window.

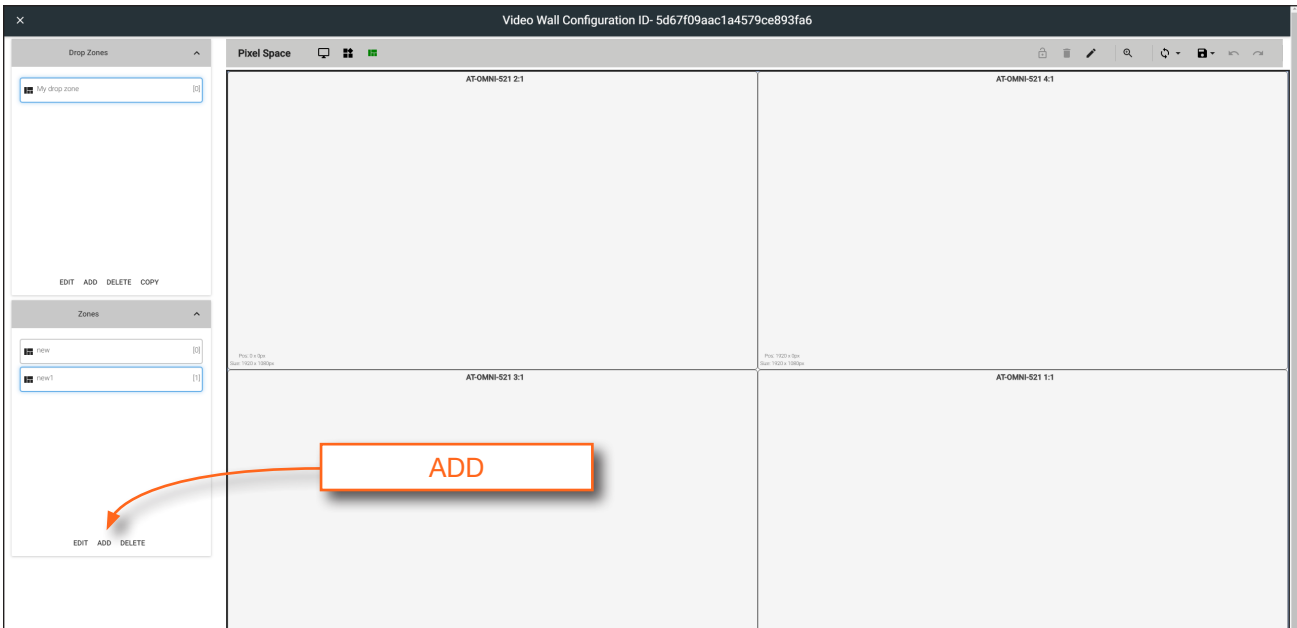

8. Click **EDIT** and provide a name for the Zone, in the **Edit Zone** dialog box. Click **Close** to save the change.

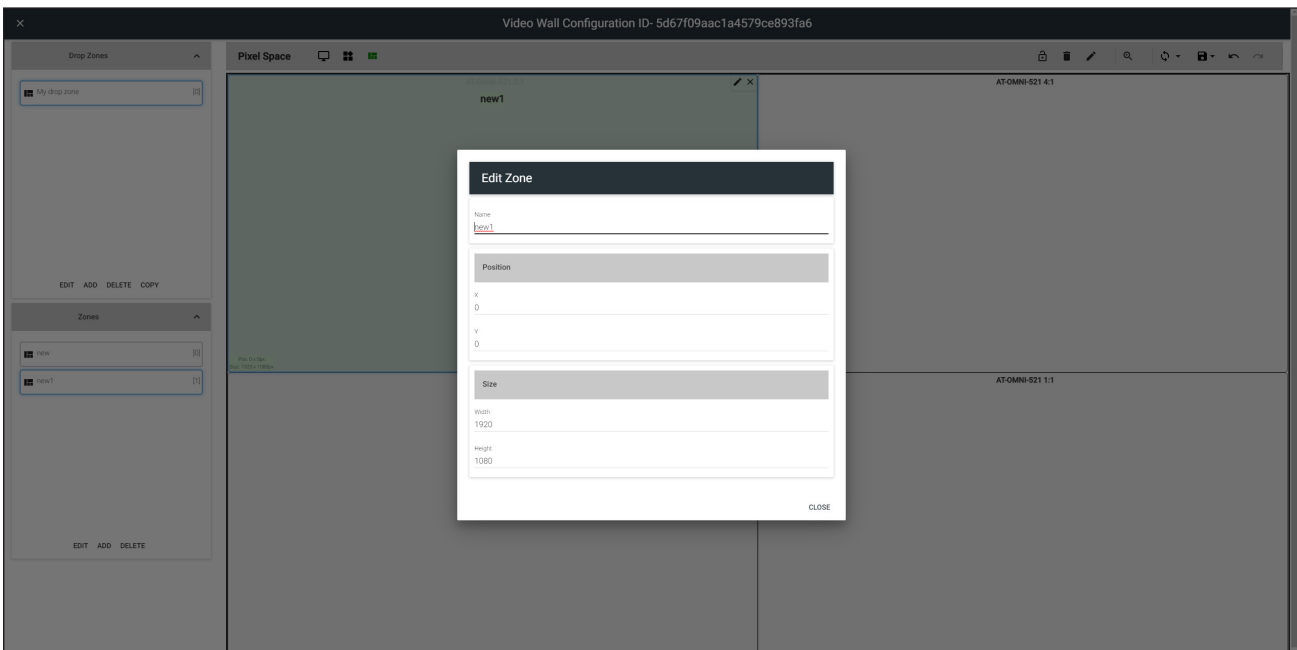

Note that each time the **ADD** button is clicked, a new Drop Zone *container* is created. In this first example, two Drop Zone containers are created. When adding containers, note that the position of each container is created in the same position, within the **Pixel Space** window.

- Drag each container to the desired area on the video wall. To place a container on each device, left-click and drag, then release when a majority of the window is placed over the device.

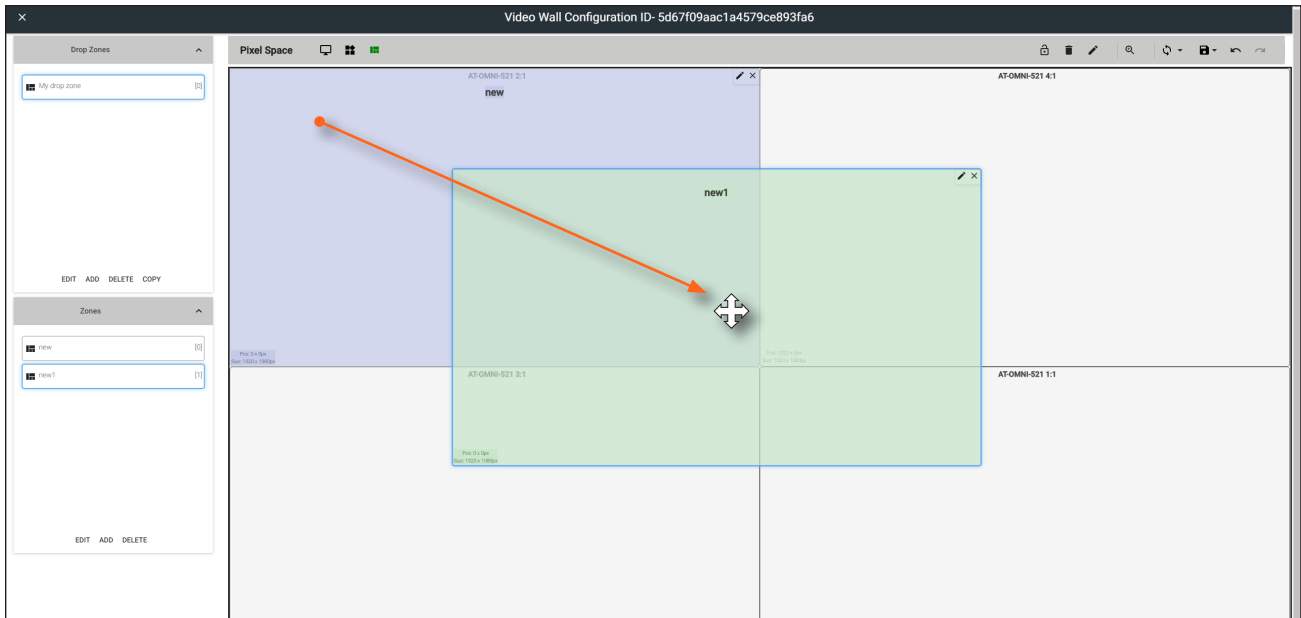

If a container is positioned over the intersection of two windows, then it will automatically be resized to accommodate both devices, as shown below. If placed over the corner intersection of more than two windows, then the container will be resized to cover all devices occupying that space.

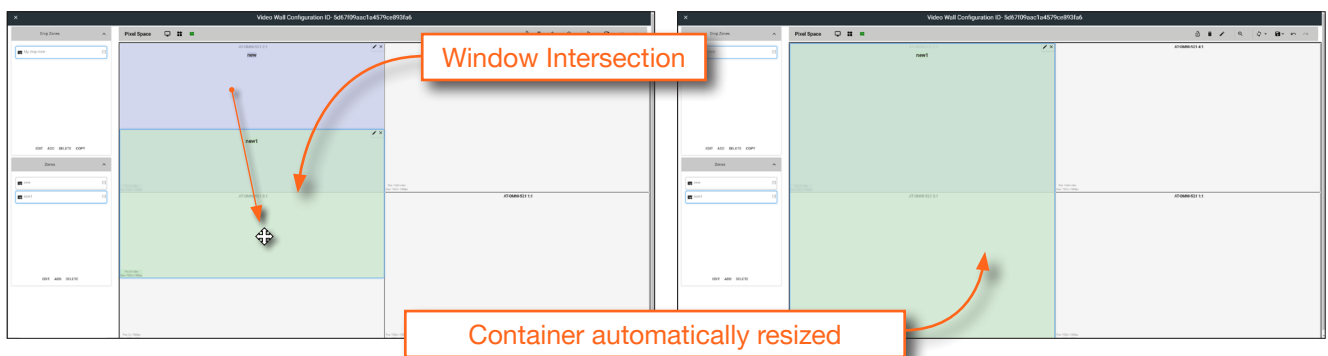

- Click the **Lock Preset** button, once the containers have been placed in the desired positions.

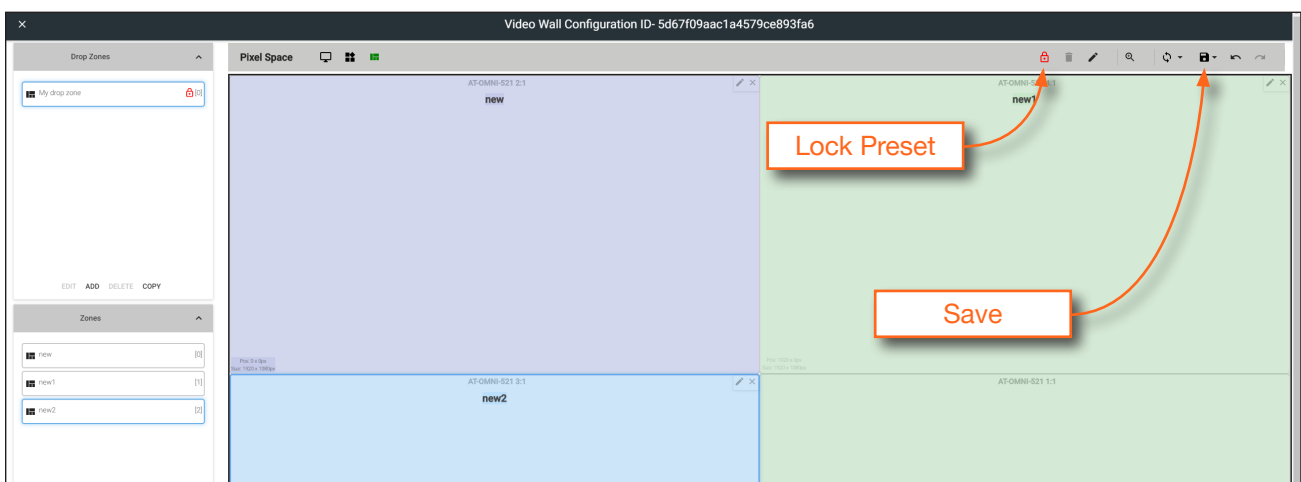

11. Repeat the above steps to create additional Drop Zone presets. Each Drop Zone preset can have a different number of containers. However, the number of containers that are created should not exceed the number of devices within the **Pixel Space** window.
12. Click the **Save** icon to commit all changes.
13. Close the **Video Wall Configuration** window, by clicking the **X**, in the upper-left corner of the screen.

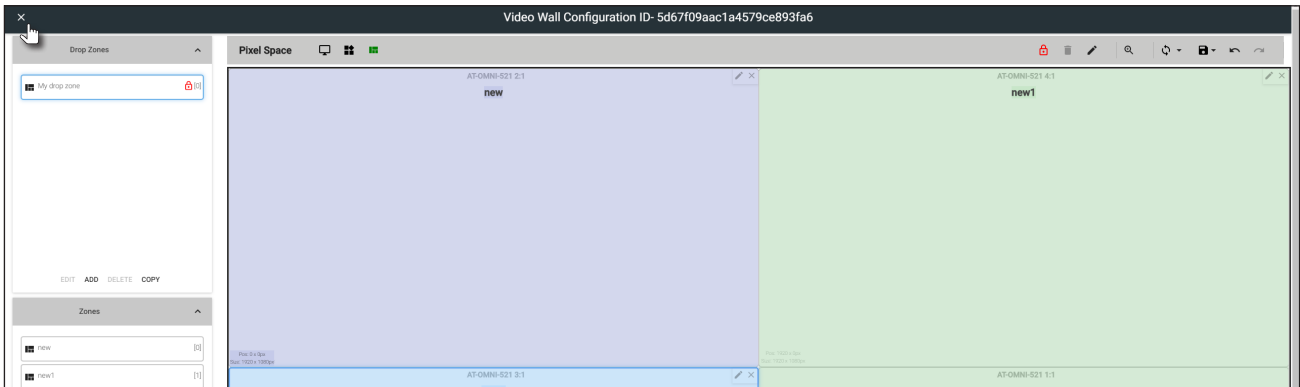

14. Click the **Launch Control** icon, in the far-left corner of the **Modify Room** screen.

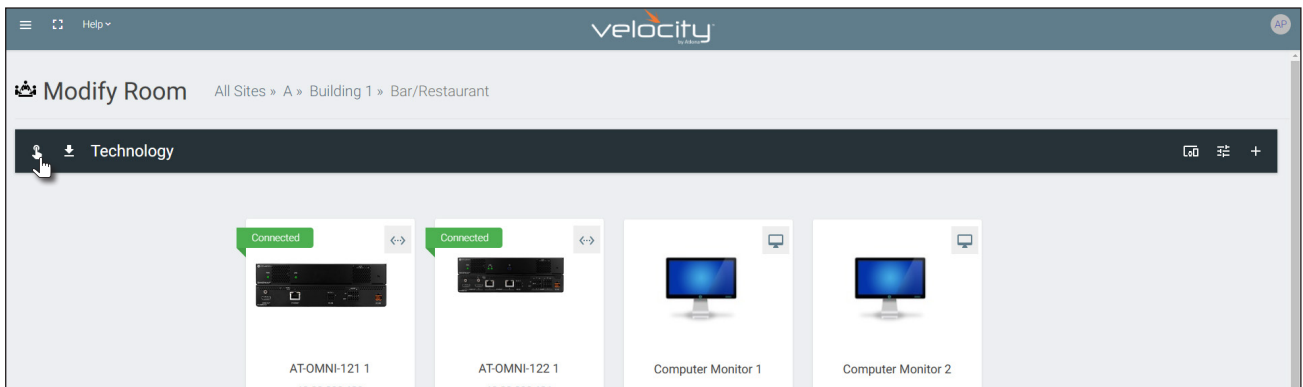

15. Click the **VIDEO WALL** icon.

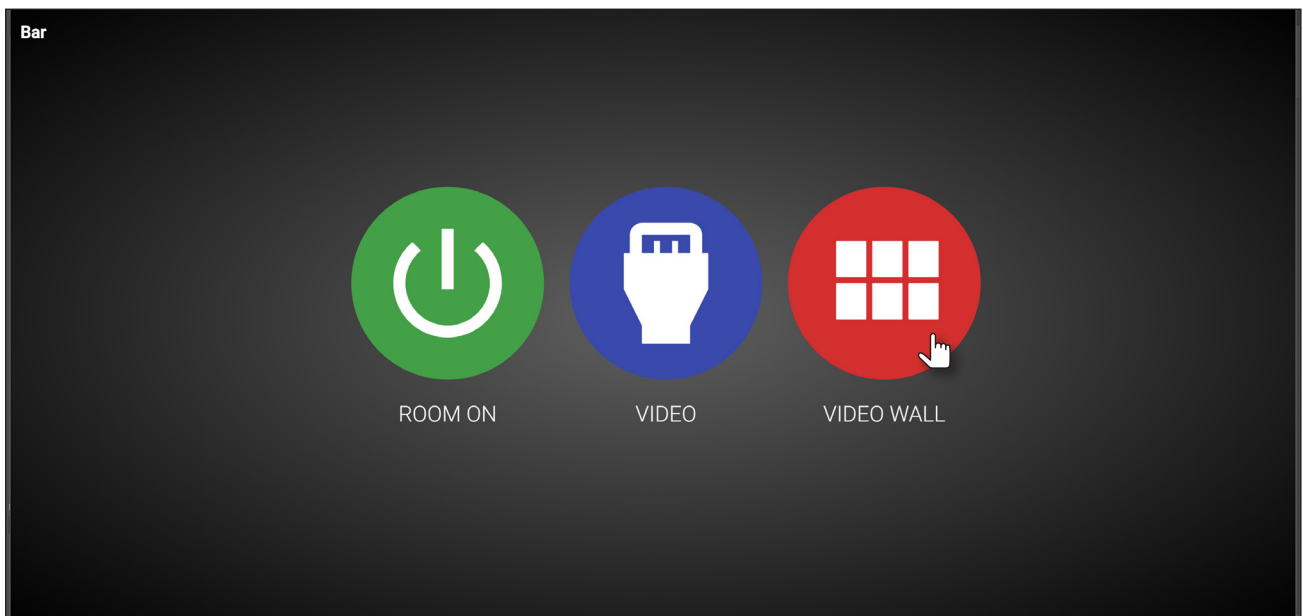

16. The **Presets** portion of the control screen will be displayed. All presets that were created, will be listed on the left-hand side of the screen, as shown below. Note in this example, only one preset was created. Click the desired preset to recall it.



17. Click **Zones**, in the lower-left corner of the screen to access the Drop Zones, which were created earlier. In the example example below, two Drop Zones were created.

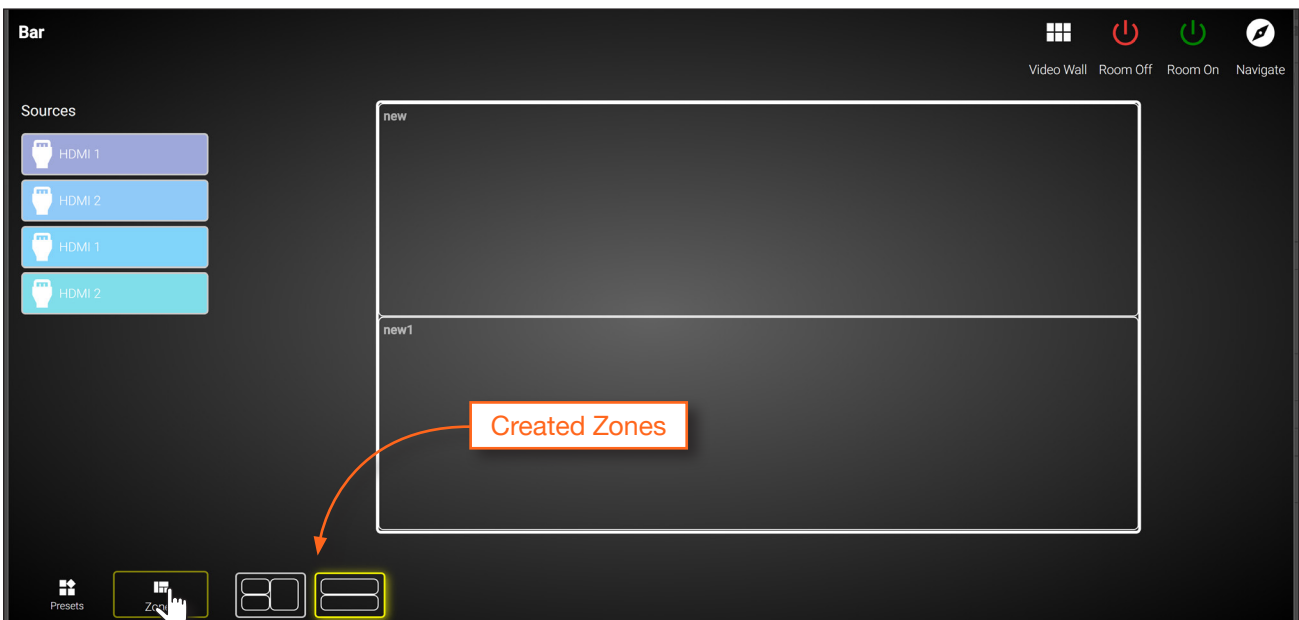

The first Drop Zone that was created, shows two containers on the left, and a single container on the right. The second Drop Zone, only uses two containers: one on the top and one on the bottom. The Preset which we created is a 2x2 video wall and represents the physical layout of the displays. Drop Zones are containers and act as a “map” to where the video sources will be applied. Refer to the next page for an example.

The first Drop Zone will can dynamically apply sources to the preset, which is a 2x2 video wall, to the top-left, bottom-left, and both or only one display(s) on the right-hand side. Some possible combinations are shown below. Drop Zone containers have been labeled alphabetically, for reference.

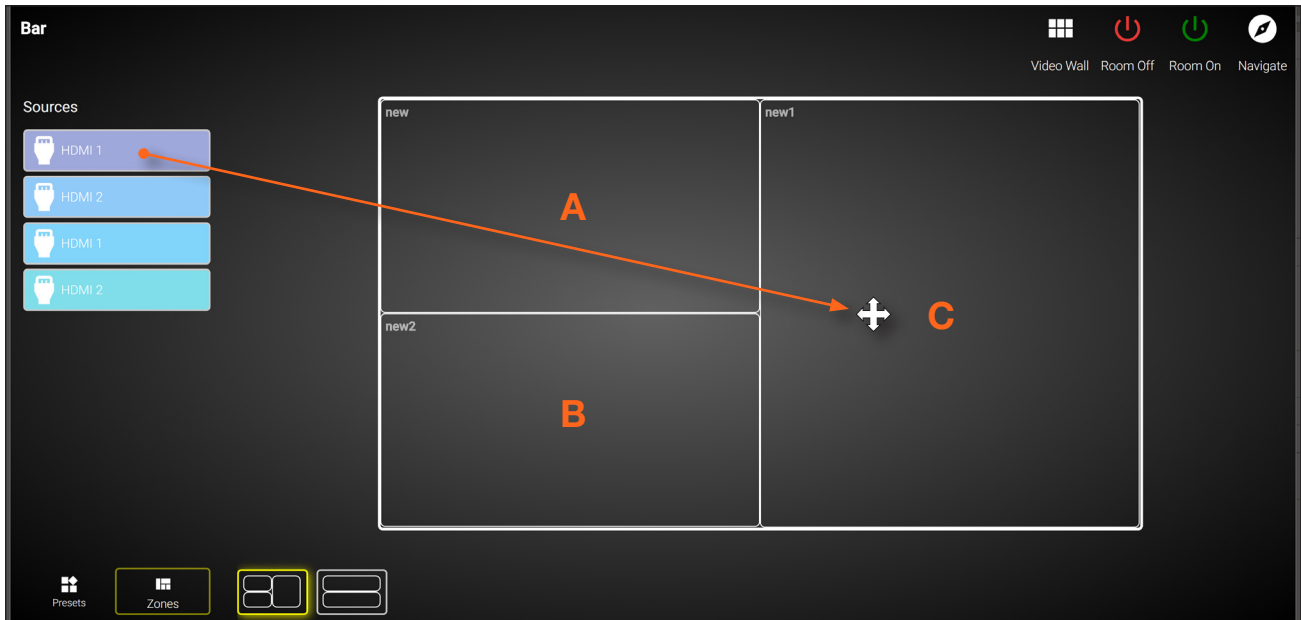

Note that although the top-right and bottom-right displays are physically separate, dragging and dropping a source from the left-hand side of the screen to Drop Zone container “C”, will “map” the source to both displays.

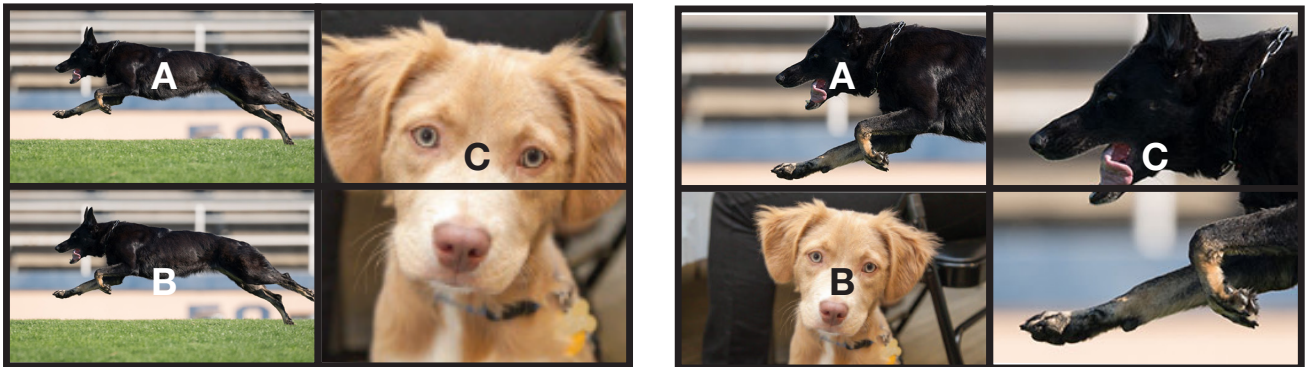

To change to a different source, drag and drop a source from the left-hand side of the screen to the source to be replaced.

Custom Drop Zones

In addition to creating user-defined Drop Zones, the Velocity Video Wall also includes a Custom Drop Zone. This unique type of Drop Zone allows dynamic re-sizing of sources to be mapped across any of the decoders.

1. Return to the **Video Wall Configuration** screen and click the **Pixel Space** icon, in the **Pixel Space** menu bar.

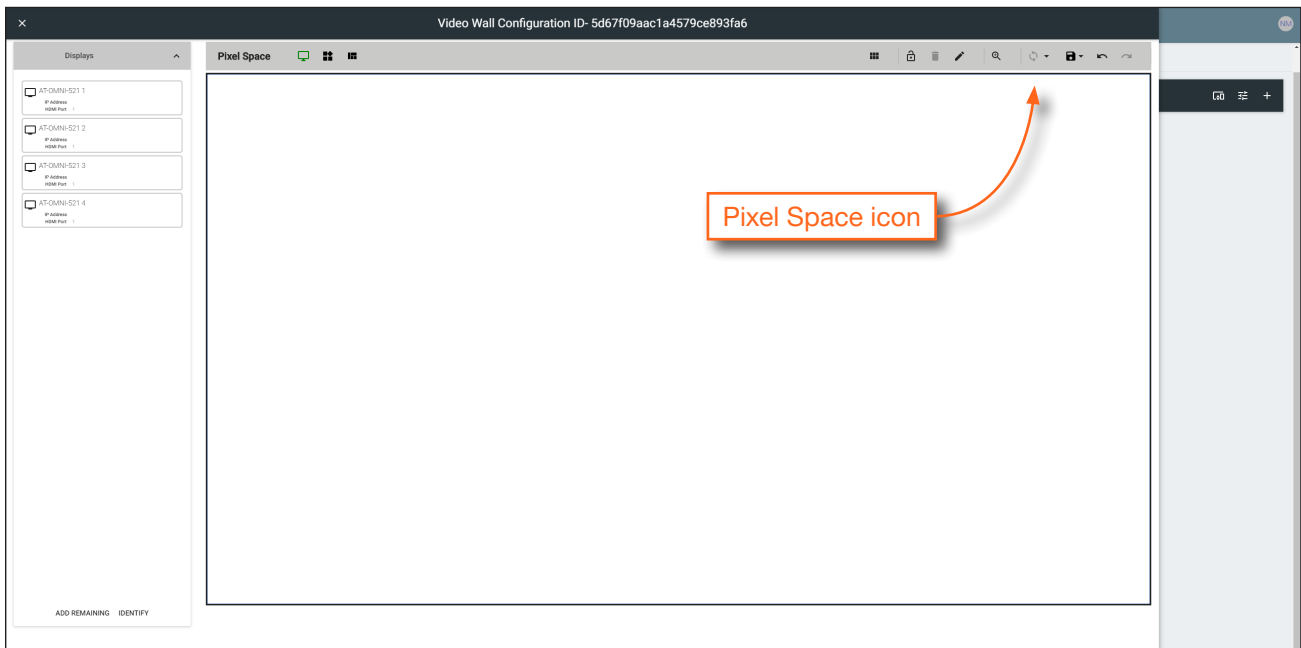

2. Click the **Allow custom drop zone** toggle switch to enable it. When enabled, this toggle switch will be green.

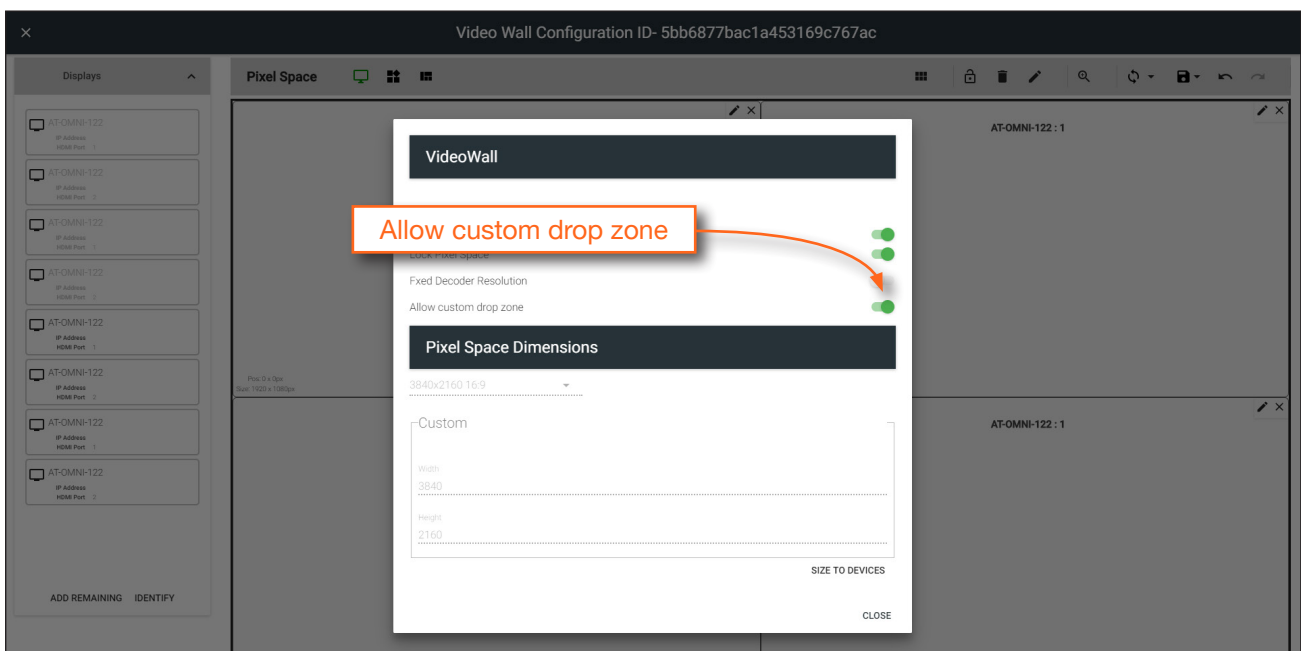

3. Click **CLOSE** to save changes and dismiss the dialog box.
4. Click the **Save** icon in the top-right portion of the **Video Wall Configuration** screen to commit changes.

5. Close the **Video Wall Configuration** screen and then click the **Launch Control** icon on the **Modify Room** screen.
6. Click the **VIDEO WALL** icon to enter video wall control screen.
7. Click **Zones** at the bottom of the screen, then click the **Custom Drop Zone** icon.

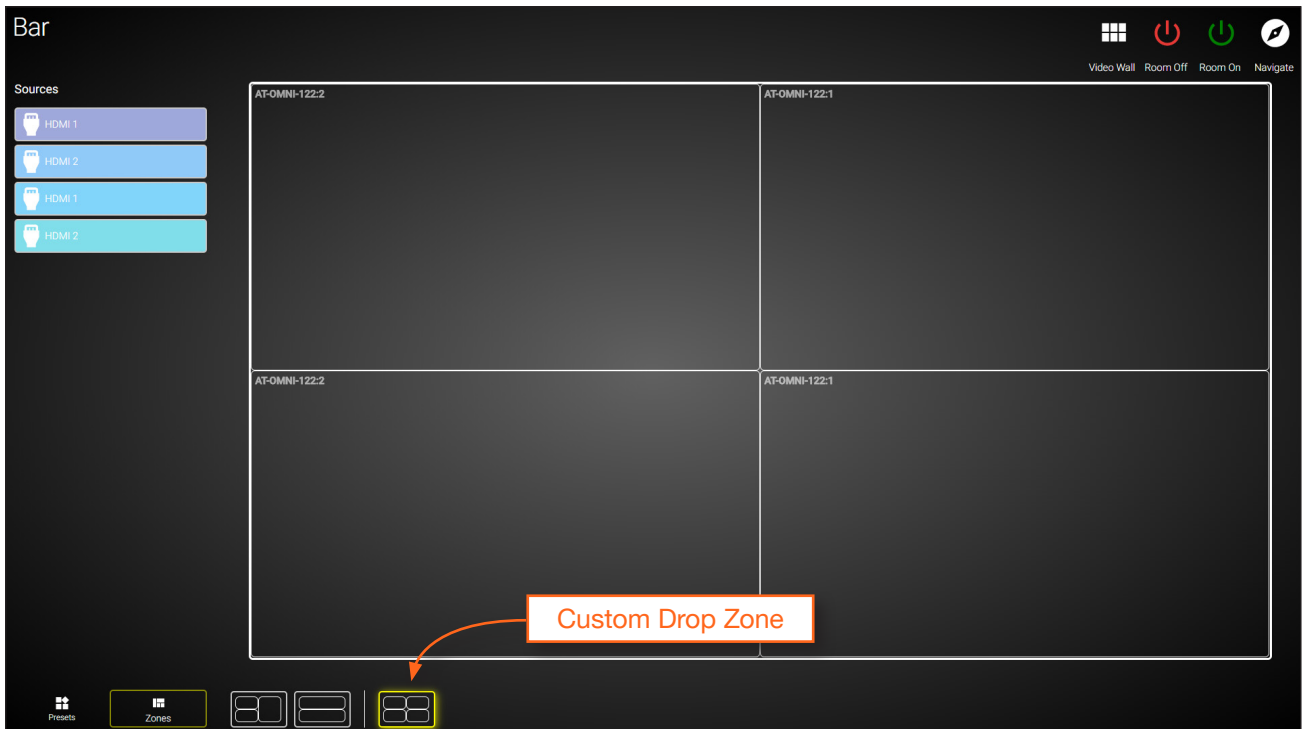

8. Drag-and-drop sources from the left side of the screen, as performed with normal Drop Zones.

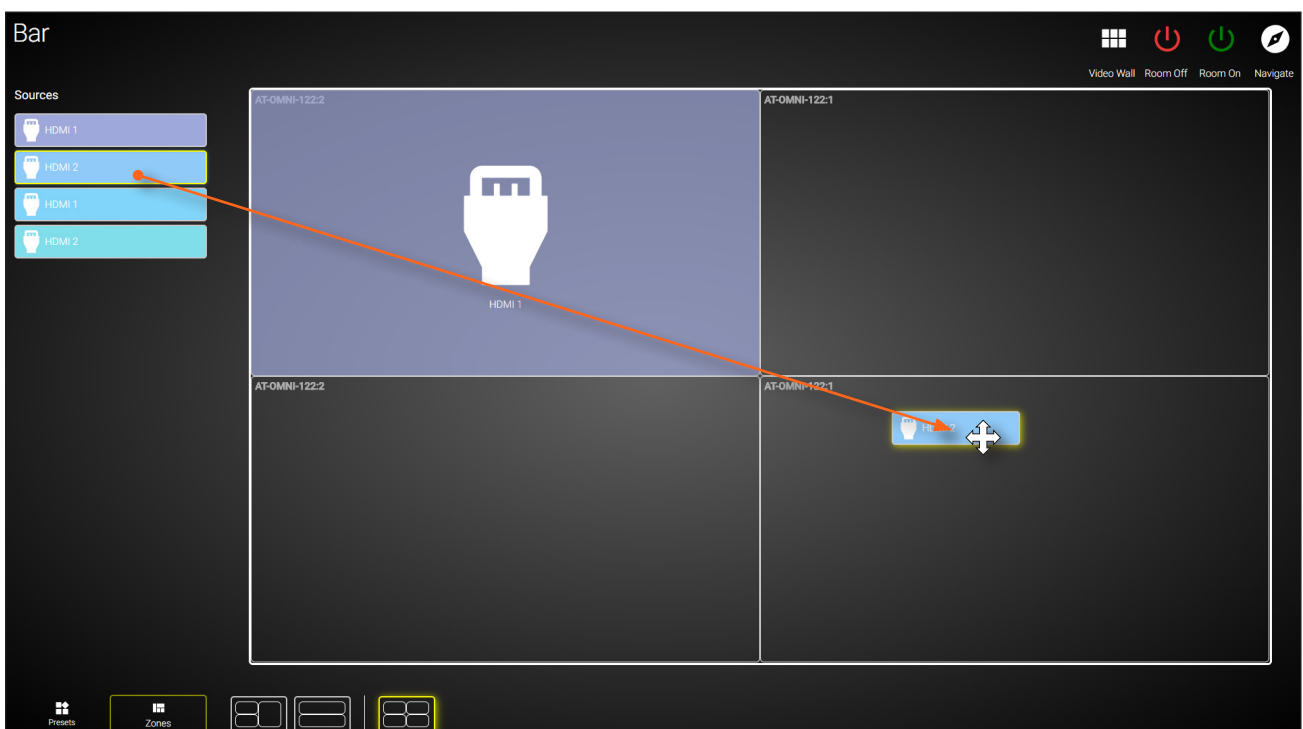

9. Resize or reposition windows by clicking and dragging the edges of each source, horizontally / vertically, to the desired area of a container.

To reposition the source to a different container(s), click in the middle of a source, then drag and drop to the desired container(s).

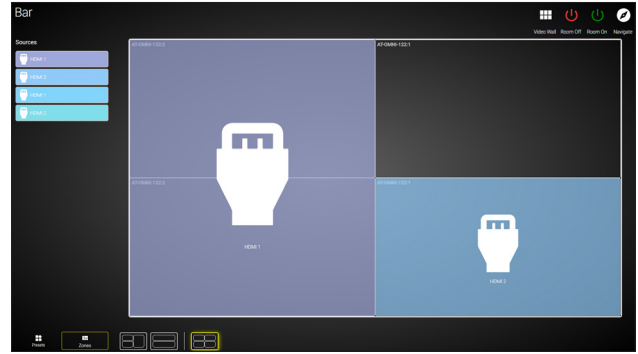
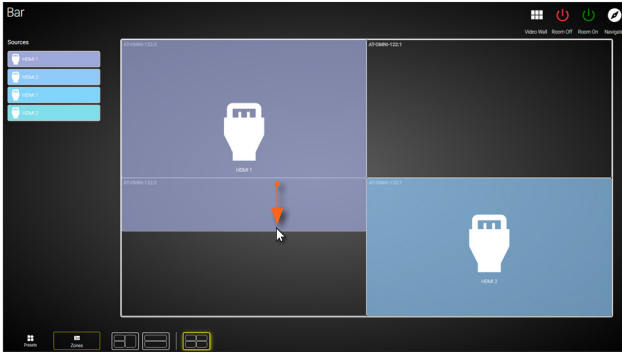

If the source is dropped at the intersection of two containers, the source will automatically be resized to fill both containers. In the example below, the source will be displayed on all four screens.

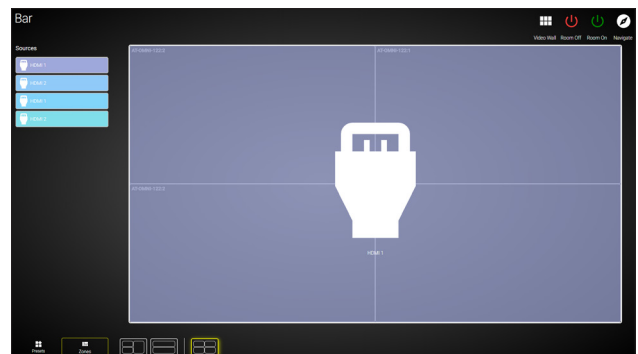
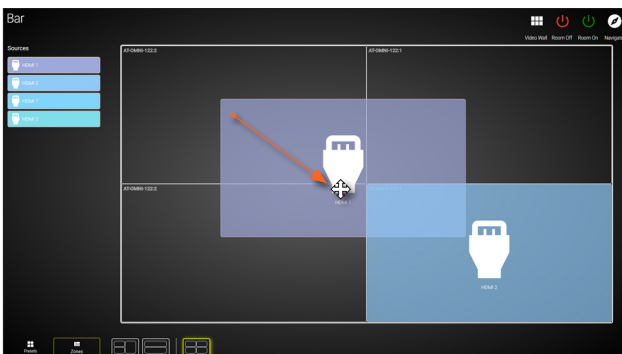

Configuring Redundant Streams

OmniStream decoders have the ability to identify missing streams, should an input be disconnected from the encoder, and will recover the image almost instantaneously. The decoder can access the same stream from two separate multicast addresses and switch between them, when necessary.

1. Login to AMS and access the Virtual Matrix. Refer to [The Virtual Matrix \(page 130\)](#) for more information.
2. In the Virtual Matrix, locate the decoder to be configured for redundancy.
3. Click the **Options** button for the desired decoder. In this example, the decoder in the upper-left corner of this matrix will be used. The **Crosspoint Options** dialog box will be displayed.

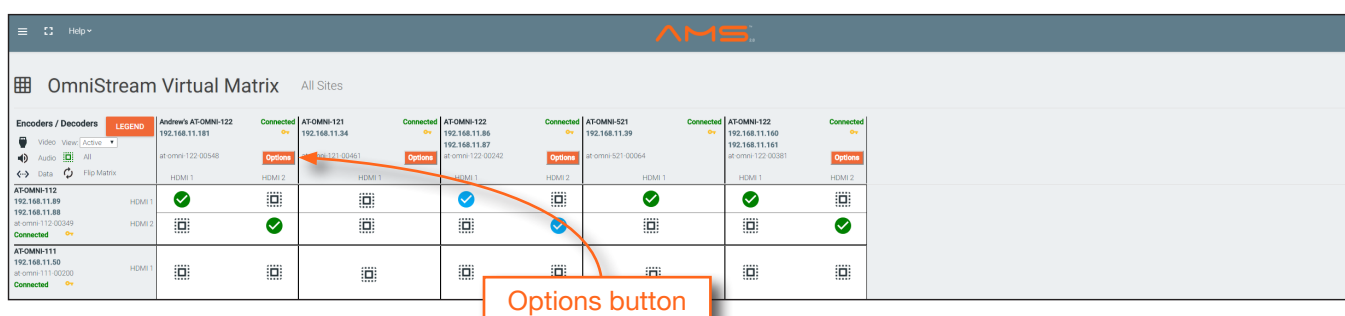

4. Select the backup mode for **Video Redundancy** and/or **Audio Redundancy** from the **Backup Mode** drop-down lists. Refer to the table below, for a listing and description of the available modes.

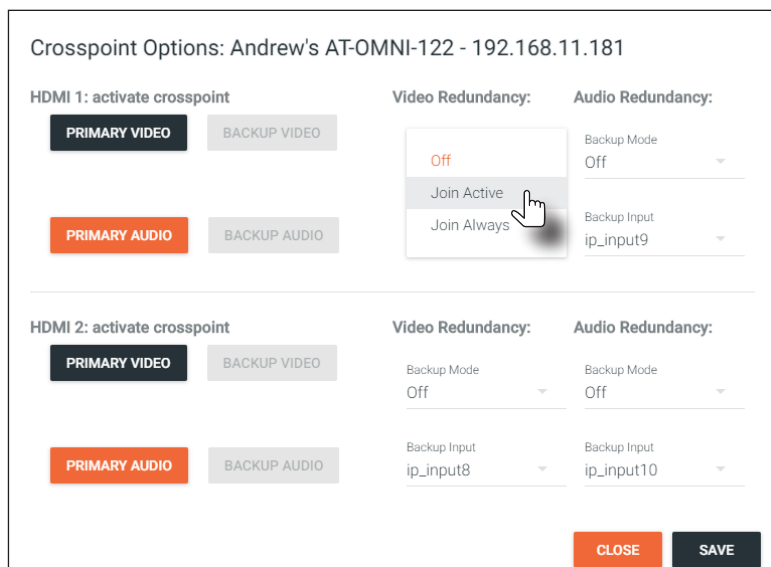

Mode	Description
Off	Redundancy off; output will never switch to the backup stream.
Join Active	The decoder sends a join request only when the primary stream is lost or if the decoder is manually switched to the backup stream. Switch time will not exceed 5 seconds.*
Join Always	The decoder joins both the Primary and Backup stream at the same time. Switch time will not exceed 0.5 seconds.

* Switching time will be dependent upon the network switch that is used, as well as the number of hops between encoders and decoders on the network.

Redundancy Grace Period

During use, the decoder can be switched to another multicast stream. However, if the decoder encounters a missing stream, during the switch and when redundancy is enabled, then this will cause the decoder to automatically failover to the multicast source configured as the backup. To prevent the decoder from automatically making the redundancy switch, when redundancy is enabled, a grace period can be entered. By default, the grace period is set to 0 seconds. If set to 0 seconds, automatic failover will occur if the stream is interrupted, for any reason. Refer to [Configuring Redundant Streams \(page 54\)](#) for more information on enabling or disabling redundancy.

1. Login to AMS. Refer to [Accessing Decoders in AMS \(page 19\)](#) if necessary.
2. Click **HDMI OUTPUT** in the menu bar.

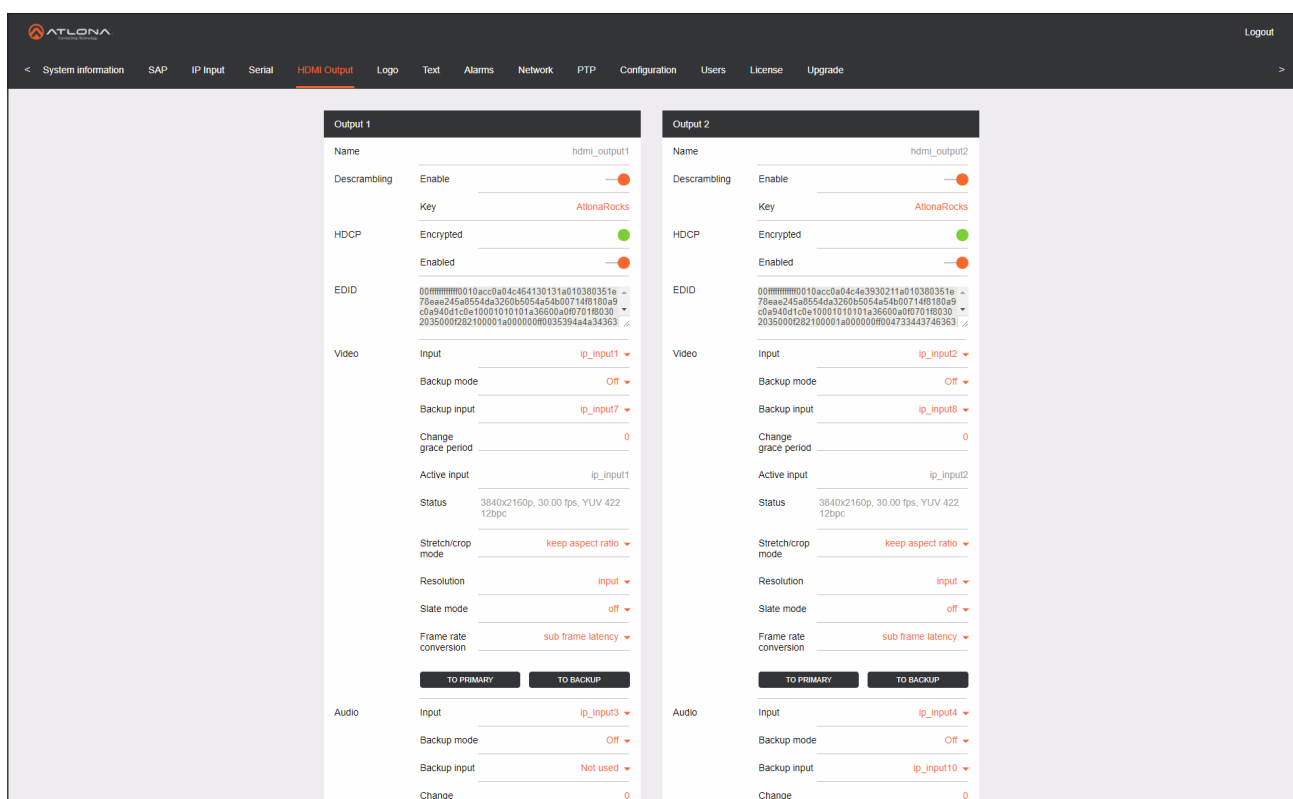

3. Locate the **Change grace period** field.
4. Enter the desired value, in seconds. By default, this value is set to 0.

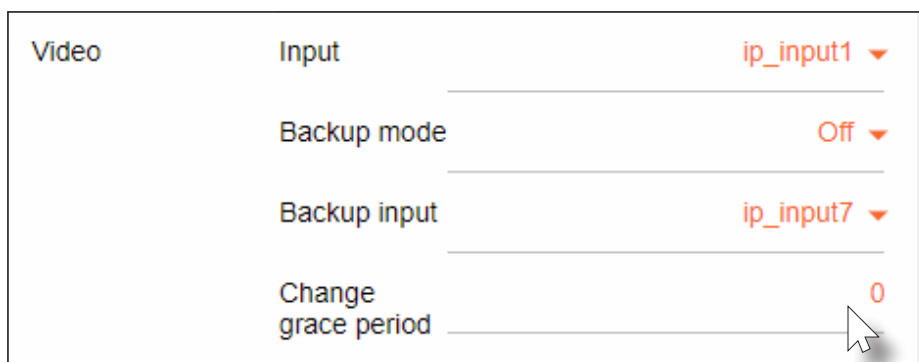

5. Click the **Save** button, at the bottom of the **Output** section.

The AMS Interface

Device Info page

The **Device Info** page provides general information about the decoder.

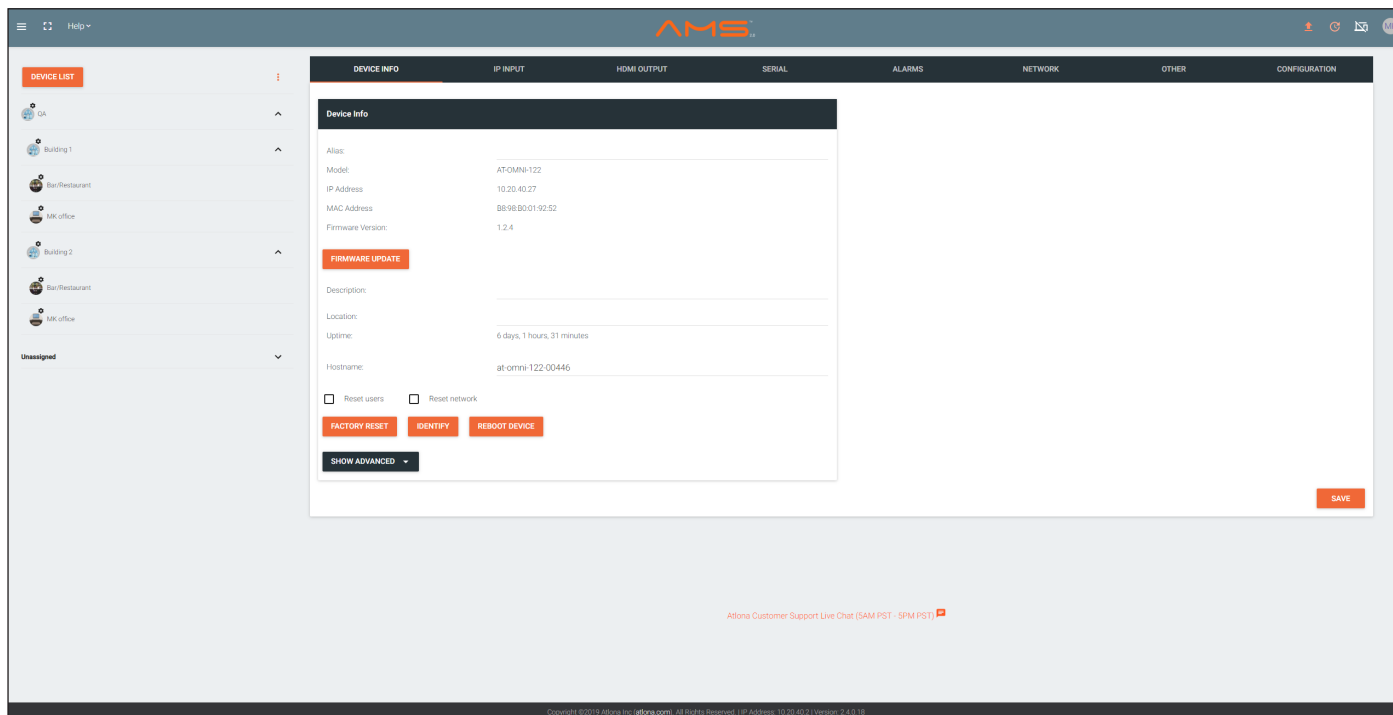

Alias

Enter a name for the unit in this field. This is optional.

Model

The model number of the unit.

Model	Description
AT-OMNI-121	Single-channel decoder
AT-OMNI-122	Dual-channel decoder

IP Address

Displays the IP address of the decoder.

MAC Address

Displays the hardware MAC address of the decoder.

Firmware version

The version of firmware that the encoder is running. Always make sure the latest version of firmware is installed.

FIRMWARE UPDATE

Click this button to update the firmware.

Description

Provides the option of assigning descriptive name to the unit.

Location

Provides the option of assigning descriptor for the location of the unit.

Uptime

Time elapsed since the last reboot operation.

Hostname

The hostname of this unit. This can be changed if desired. By default, the host name is automatically created using the model of the unit and adding the last five digits of the unit serial number.

FACTORY RESET

Click this button to reset the encoder to factory-default settings. When performing a factory reset, the following options can be selected, by clicking the check box. If no options are selected, then the encoder is reset with no factory-default settings.

Option	Description
None Checked	Resets the decoder with no factory-default settings.
Reset User	Resets the decoder to factory-default settings and resets custom user information.
Reset Network	Resets the decoder to factory-default settings and resets network information.
Reset Defaults	Resets the decoder to factory-default settings. In addition, static multicast addresses are configured. This option can be used to configure a single encoder to transmit to any number of decoders without using the Virtual Matrix within AMS.  IMPORTANT: This option will not work for multiple decoders on the same network.

IDENTIFY

Click this button to physically identify a unit on the network. Clicking this button will cause all front-panel LED indicators to flash for 10 seconds.

REBOOT DEVICE

Click this button to perform a soft reboot of the encoder.

Advanced Settings

Click the **SHOW ADVANCED** button to view the following options.

Timezone

Click this drop-down list to select the time zone, expressed in Universal Coordinated Time (UTC).

System Temperature

The current internal temperature of the unit listed in both degrees Fahrenheit and Celsius.

Die Temperature

The component chip temperature listed in both degrees Fahrenheit and Celsius.

Power Consumption

The current power consumption value.

Dolby Vision License Enabled

This indicator will be green if the Dolby Vision license is installed.

Dolby Vision License Key

Enter the license key in this field, then press the **SAVE LICENSE** button.

SAVE LICENSE

Click this button to activate a valid Dolby License key.

NTP Server

Specify the desired NTP server in this field. This provides timestamps for any logs and alarms.

Buttons

Disabling this feature will lock the ID button on the front panel. This feature is enabled by default.

LEDs

Disabling this feature will turn off all LED indicators on the front panel. This is enabled by default.

IP Input page

The **IP Input** tab provides configuration of each input, the assigned multicast address(es), and ports.

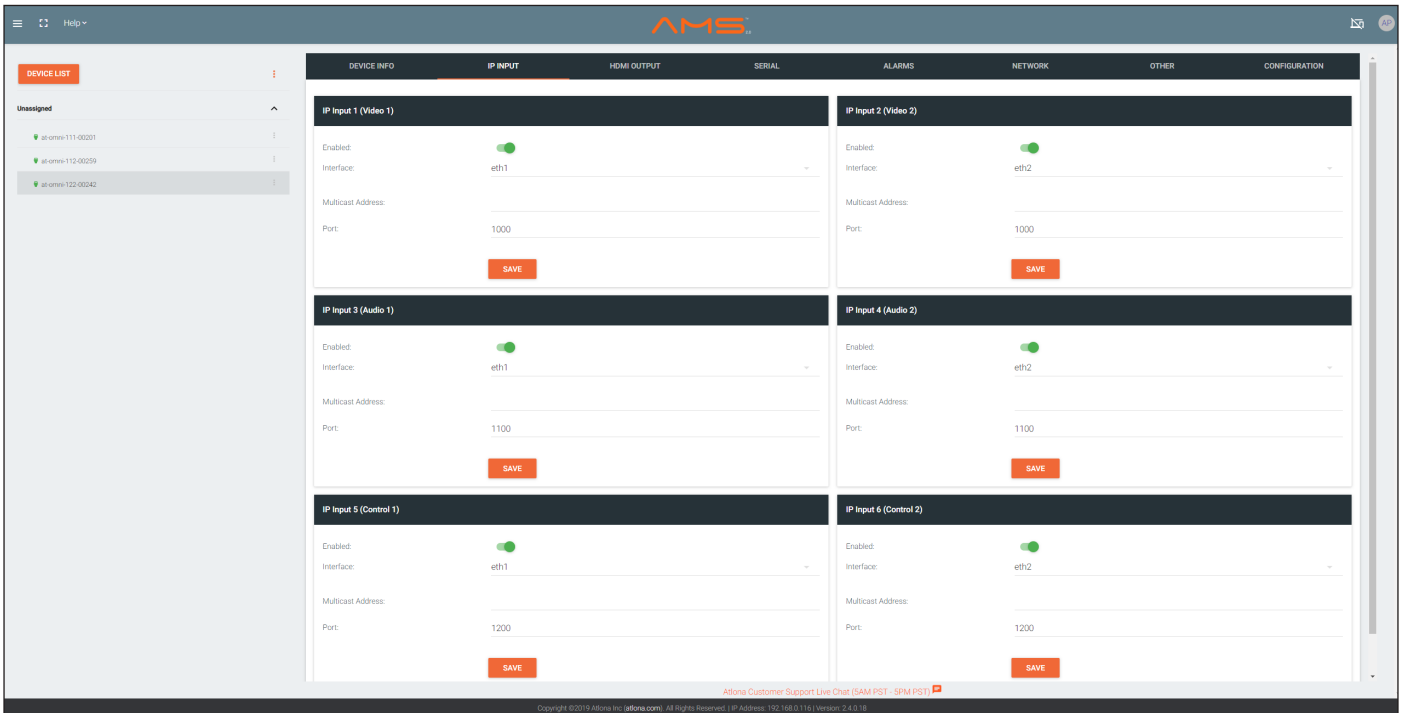

Enabled

Click this checkbox to enable the IP input.

Interface

Select the physical interface, that will be used to carry the multicast traffic, from this drop-down list. When using a single-channel decoder, only **eth1** will be available.

Input	Description
eth1	ETHERNET 1 port
eth2	ETHERNET 2 port

Multicast Address

Enter the multicast address of the decoder stream.

Port

Enter the multicast UDP listening port in this field.

Advanced Settings

Mode

Click this drop-down list to select the mode. Mode can be set to exclude or include and is specifically used when using Source Specific Multicast (SSM). SSM will only function if the network is properly set up to support it.

Mode	Description
exclude	Multicast content coming from the source mentioned in the Addresses section will be excluded (blocked).
include	Multicast content coming from the source mentioned in the Addresses section, on the next page, to be streamed to the decoder.

Addresses

Enter the IPv4 address of the encoder(s) in this field and is used as the SSM include/exclude list. Use the comma delimiter to separate multiple IP addresses. When using non-SSM networks, this field is ignored.

HDMI Output page

The **HDMI Output** tab provides options to configure the output streams.

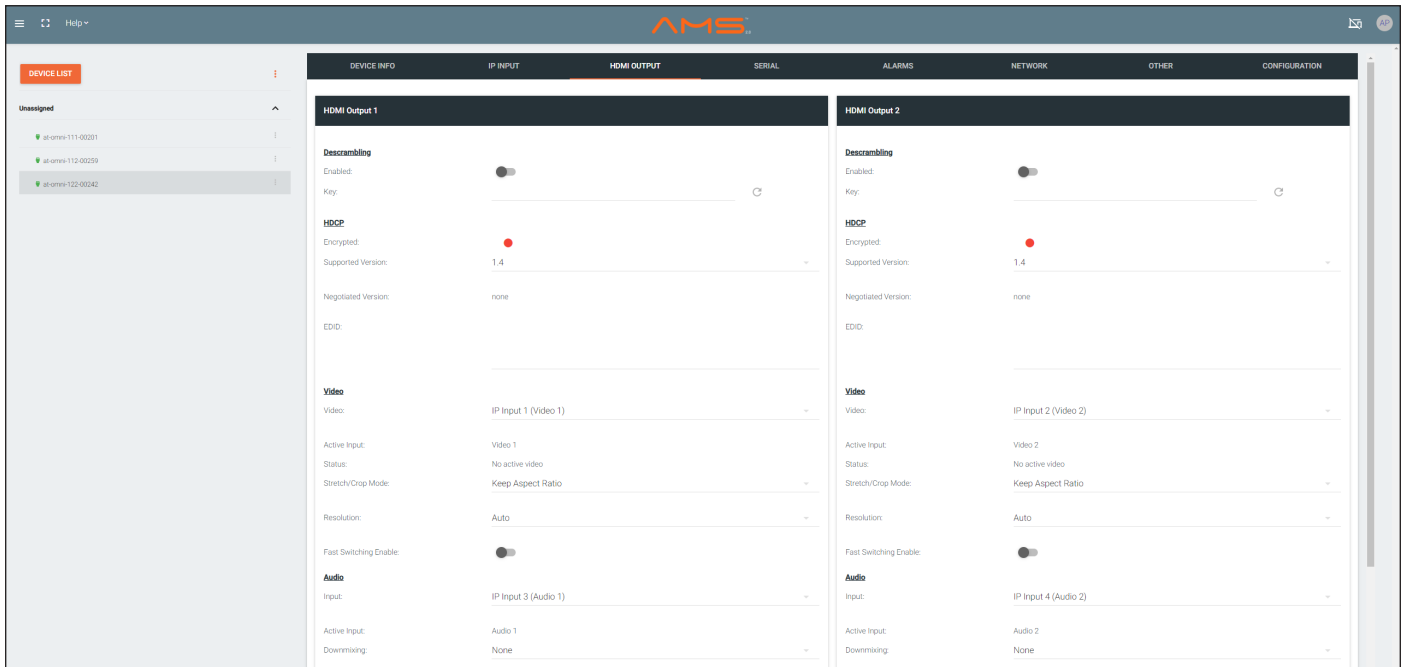

Enabled

Click this toggle switch to enable or disable scrambling on the decoder. When enabled, the toggle switch will be green.

Key

Enter the scrambling key in this field. The scrambling key must be ASCII and must contain a minimum of eight characters. Special characters and spaces are not permitted.

Encrypted

Indicates if the content is HDCP-encrypted or not. If true, then HDCP content is being passed in to the decoder and this indicator will be colored green.

Supported Version

Click this drop-down list to select the desired HDCP version. If set to none, then the sink is reported as “non-compliant” and will receive non-HDCP content.

Input	Description
none	The decoder will receive non-HDCP content.
1.4	The decoder will receive HDCP version 1.4 content.
2.2	The decoder will receive HDCP version 2.2 content.

Negotiated Version

The version of HDCP being received.

EDID

This is a read-only field and cannot be modified. The data in this field is the EDID of the display to which the decoder is connected. This EDID data in this field can be copied to the encoder, allowing the source to send AV formats which are supported by the sink (display) device. Refer to the AT-OMNI-11x User Manual for more information.

Video

Click this drop-down list to select the desired primary video input. Select **generator** to use the internal signal generator. Select the **Not Used** option to leave the video input unassigned.

Active Input

Displays the active video input.

Status

Displays the input status. If no input is active or detected, then this field will display “No active video”.

Stretch / Crop Mode

Click this drop-down list to select the aspect ratio.

Mode	Description
Keep Aspect Ratio	Aspect ratio is preserved; the output on the decoder will be the same as the input on the encoder.
Full Screen	Stretches the image to fill the screen. In some cases this can distort (“stretch”) the image.
16:9	Sets the aspect ratio to 16:9 “widescreen” format, usually associated with HDTV formats.
16:10	Sets the aspect ratio to 16:10 “widescreen” format, usually associated with computer displays and smart devices.
4:3	Sets the aspect ratio to 4:3 “pan-and-scan” format, usually associated with SDTV.

Resolution

Click this drop-down list to select the desired output resolution. This is a scaler feature which can either upscale or downscale the output on the decoder. If **Input** is selected, then no scaling will be applied to the output. Select **Auto** to use the EDID of the sink device to determine the output resolution.

Resolutions	
Input	1440 x 1050
Auto	1440 x 900
4096 x 2160	1280 x 1024
3840 x 2160	1280 x 800
1920 x 1200	1280 x 768
1920 x 1080	1280 x 720
1680 x 1050	1024 x 768
1600 x 900	



NOTE: When working with VESA resolutions 1360x768p60 and 1366x768p60, the **Resolution** drop-down list must be set to **Auto**.

Fast Switching Enable

Click this toggle switch to enable or disable fast-switching. Refer to [Fast Switching \(page 37\)](#) for more information.

Input

Click this drop-down list to select the primary audio IP input. Select the **Not Used** option to leave the audio input unassigned.

Active Input

Displays the active audio IP Input.

Downmixing

Click this drop-down list to select how LPCM audio will be down-mixed. Note that lossless audio formats cannot be down-mixed.

Type	Description
None	Audio is not down-mixed.
Stereo	Audio is down-mixed to two-channel stereo.
Auto	Audio is down-mixed per the EDID of the connected HDMI device.

Status

Displays the audio input status. If no input is active or detected, then this field will display “No active audio”.

Mute

Click this toggle switch to enable or disable the audio output. If enabled, the toggle switch will be green.

Volume

Click the speaker icon on the left to decrease volume. Click the speaker icon on the right to increase volume. Range: 0 to 15.

Advanced Settings

Click the **SHOW ADVANCED** button to view the following options.

Backup Mode

Click this drop-down list to select the backup mode. Both Video and Audio provide the Backup Mode feature.

Mode	Description
Off	Backup source is disabled; join request not sent.
Join Active	The decoder sends a join request only when the decoder decides to switch between audio sources. Switch time will not exceed 5 seconds.
Join Always	The decoder always joins to the backup audio source. Switch time will not exceed 0.5 seconds.

Backup Input

Select the secondary video backup IP input from this drop-down list. If the primary IP input is down, then the decoder will automatically switch to this input. Refer to the **Backup Mode** option, above, for setting the conditions for switching inputs. Both Video and Audio provide the Backup Input feature.

Configuration Grace Period

To prevent the decoder from automatically making the redundancy switch, when redundancy is enabled, a grace period can be entered. By default, the grace period is set to zero seconds. If set to zero seconds, automatic failover will occur, if the stream is interrupted for any reason. Refer to [Configuring Redundant Streams \(page 111\)](#) for more information.

Slate Mode

Click this drop-down list to select the slate mode. Refer to [Slate / Logo Insertion \(page 31\)](#) for more information.

Mode	Description
Off	Disables the image from being displayed.
Manual	Stretches the image to fill the screen. In some cases this can distort (“stretch”) the image.
Auto	The image will only be displayed when the source signal is lost. For example, this mode is useful in conference room applications for displaying system instructions when no sources are connected.

Enable

Click this toggle switch to enable or disable the video wall feature. When enabled, the toggle switch will be green. Refer to [Creating Video Walls \(page 73\)](#) for more information.

TO PRIMARY

Click this button to assign as the Primary IP Input. Both Video and Audio support this feature.

TO BACKUP

Click this button to force the audio stream to fall over to the Backup IP Input (if redundancy is configured). Both Video and Audio support this feature.

Enable AES67

Click this toggle switch to enable or disable AES67. When enabled, the toggle switch will be green. Refer to [AES67 Audio \(page 70\)](#) for more information.

Status

This field will display the audio type. If no audio is present, then this field will display **No active audio**.

Analog Power Status

This indicator will be green when the decoder is powered by the optional external 48 V DC power supply.

Analog Power

If analog output is connected to the decoder, then click this toggle switch to use the analog audio output. When enabled, this toggle switch will be green.

Auto On

Click this toggle switch to enable or disable power-on. When enabled this toggle switch will be green and the power-on command will be sent to the display when an A/V signal is detected.

Projector Cooldown (s)

Enter the time interval, in seconds, before the projector can be powered-off. This time interval prevents the decoder from sending additional commands until the projector has had time to complete its cool-down process.

Standby Timeout

Enter the time interval, in seconds, before the next command can be accepted by the display.

Type

Click this drop-down list to select the display mode.

Type	Description
DispSW AVon	Display switches on/off, source audio/video signal always on.
DispSW AVSW	Display switches on/off, source audio/video signal switches on/off.
AV SW	Display is always on, source audio/video signal switches on/off
Always on	Display is always on, source audio/video signal always on.

Auto On

Click this toggle switch to enable or disable power-on. When enabled this toggle switch will be green and the power-on command will be sent to the display when an A/V signal is detected.

Video Optimization

Sets the video mode to optimize the output for motion video or computer graphics. Refer to [Setting the Video Mode \(page 30\)](#) for more information.

Serial page

The **Serial Config** tab provides serial port configuration when using control signals.

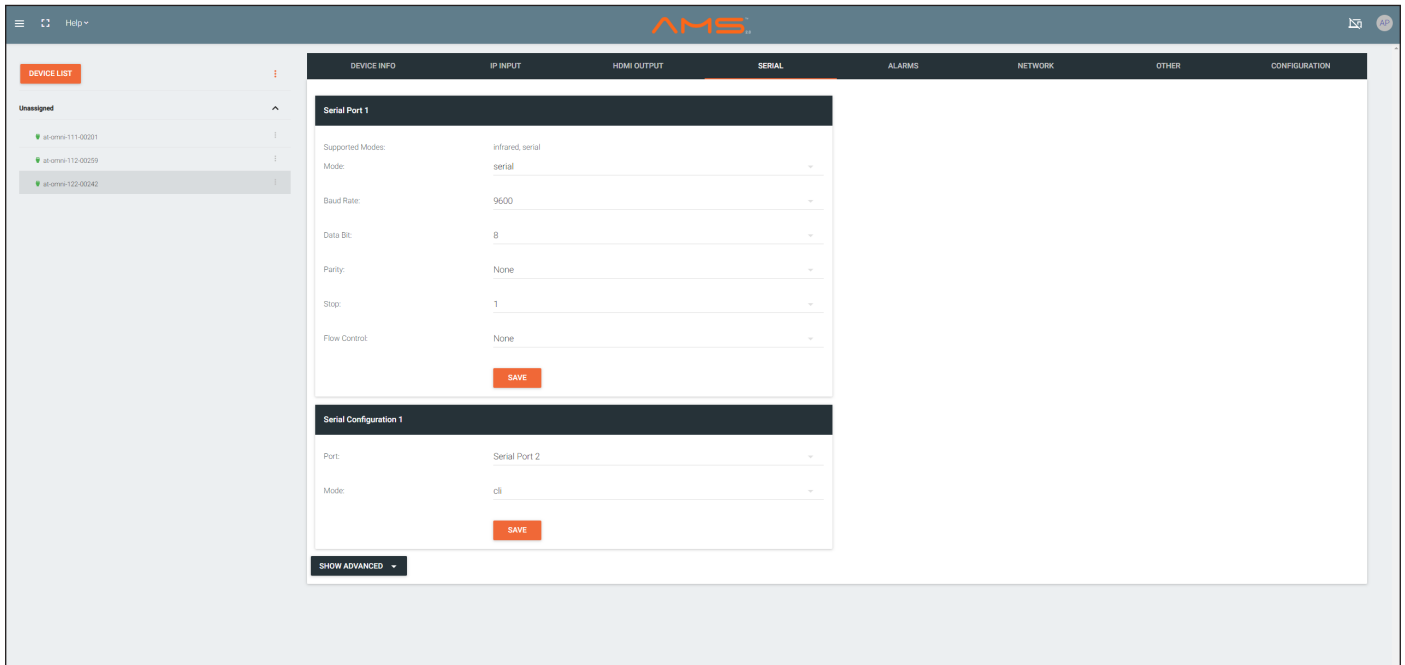

The screenshot displays the AMS Serial Configuration page. On the left, there is a 'DEVICE LIST' sidebar with three entries: 'at-omni-111-00201', 'at-omni-112-00209', and 'at-omni-122-00242'. The main content area is titled 'Serial Port 1' and contains the following configuration options:

- Supported Modes: infrared, serial
- Mode: serial
- Baud Rate: 9600
- Data Bit: 8
- Parity: None
- Stop: 1
- Flow Control: None

Below these options is a 'Serial Configuration 1' section with the following settings:

- Port: Serial Port 2
- Mode: cli

A 'SHOW ADVANCED' button is located at the bottom left of the configuration area.

Supported Modes

Lists the supported protocols.

Mode

Click this drop-down list to select the desired serial mode: Infrared or Serial.

Baud Rate

Click this drop-down list to select the desired baud rate.

Data

Click this drop-down list to select the number of data bits.

Parity

Click this drop-down list to select the parity bit.

Stop

Click this drop-down list to select the stop bit.

Flow

Click this drop-down list to select the type of flow control.



NOTE: The single-channel decoder will only have one **Serial Port Configuration** section.

Advanced Settings

Click the **SHOW ADVANCED** button to view the following options.

Port

Click this drop-down list to select the port: **serial_port1**, **serial_port2**, or **Not Used**.

Mode

Click this drop-down list to select the desired control mode.

Interface	Description
cli	Displays the command-line interface of the decoder.
output	Serial port will send commands directly to the display device.
tcp proxy	Commands are sent over IP but triggered over the serial port.

Command

Each of these The **Command** blocks are used to enter the command string for the desired operation: Display Off, Display On, Volume Down, and Volume Up.

Mode

Click this drop-down list to select where the command will be interpreted.

Interpret on	Description
Raw	Commands are interpreted at the encoder.
Decoder	Commands are interpreted at the decoder.

ASCII

Enter the ASCII representation of the command string in this field.

HEX

Enter the hexadecimal representation of the command in this field.



NOTE: When entering the command string, it is not required to enter the string under both the ASCII and HEX fields. The decoder requires that only one field be completed.

Network page

The **Network** page provides the ability to enable or disable DHCP mode for each video channel. When DHCP mode is disabled, the IP address, subnet mask, and gateway must be provided. If using the dual-channel version, then the information on both Channel 1 and Channel 2 are provided. This screen is identical to the **Network** page for the encoder.

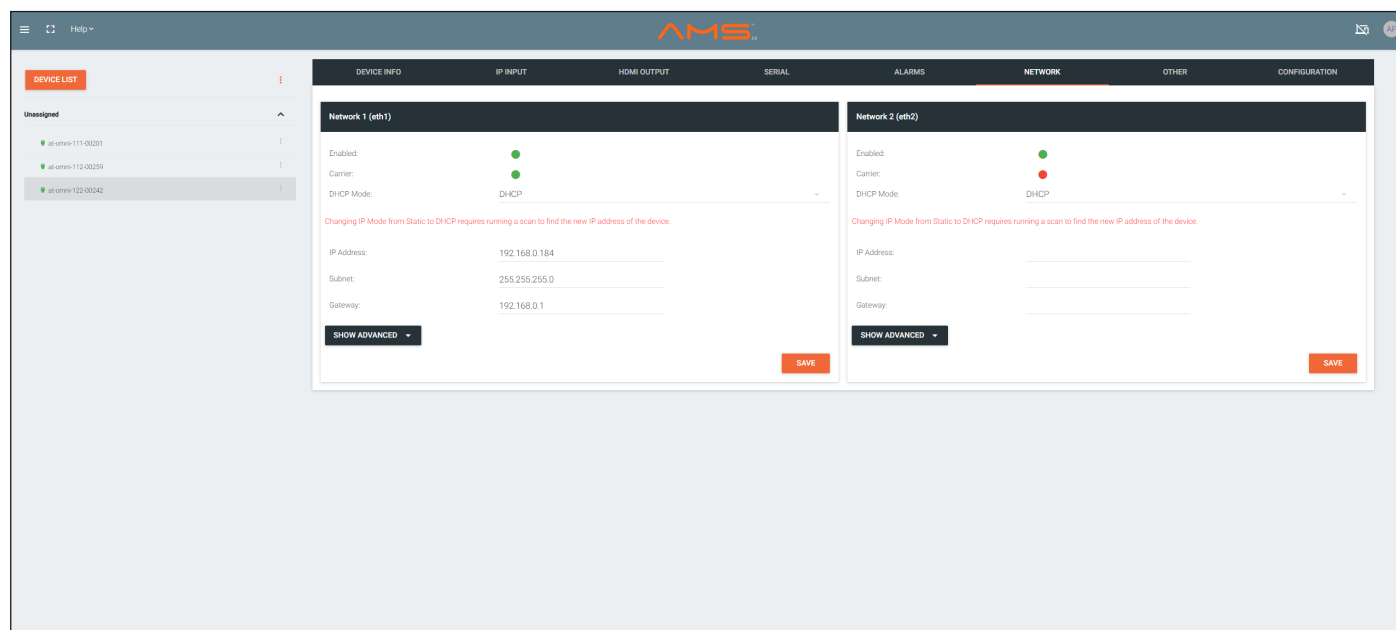

Enabled

This indicator displays whether or not the video stream for this channel is active. If the indicator is green, then the video stream is active.

Carrier

If this indicator is green, then an active link exists. Otherwise, if no link exists, this indicator will be red.

DHCP Mode

Click this drop-down list to select the desired network mode. Select DHCP to let the DHCP server (if present) assign the encoder the IP settings; **Subnet** and **Gateway** fields will automatically be populated. When **Static** mode is selected, the information for the **IP Address**, **Subnet**, and **Gateway** fields must be entered.

IP Address

Displays the IP address used by the channel. This field can only be changed if **Static** mode is selected.

Subnet

Displays the subnet mask for the channel. This field can only be changed if **Static** mode is selected.

Gateway

Displays the gateway (router) address for the channel. This field can only be changed if **Static** mode is selected.

Advanced Settings

Click the **SHOW ADVANCED** button to view the following options.

Link Speed

Displays the port speed in Mbps.

MAC Address

The MAC address of the Ethernet channel.

Telnet Authentication

Click this toggle switch to enable or disable Telnet authentication. If enabled, then the toggle switch will be green. Once enabled, connecting to the encoder using Telnet will require login credentials. The default credentials are:

Username: admin
Password: Atlona

802.1x Mode

Click this drop-down list to select the desired authentication mode. Refer to [802.1X Authentication \(page 67\)](#) for more information.

Other page

The **Other** page provides logo/slate, text, and PTP management. Click the menu in the upper-left corner of the AMS screen to switch between **Logo**, **Text**, **PTP**, and **SAP** screens.

Logo

The **Logo** page provides the ability to upload a custom logo. This logo will be displayed when no video signal is detected. Separate logos can be uploaded: one for each channel. Refer to [Slate / Logo Insertion \(page 31\)](#) for more information on these settings.

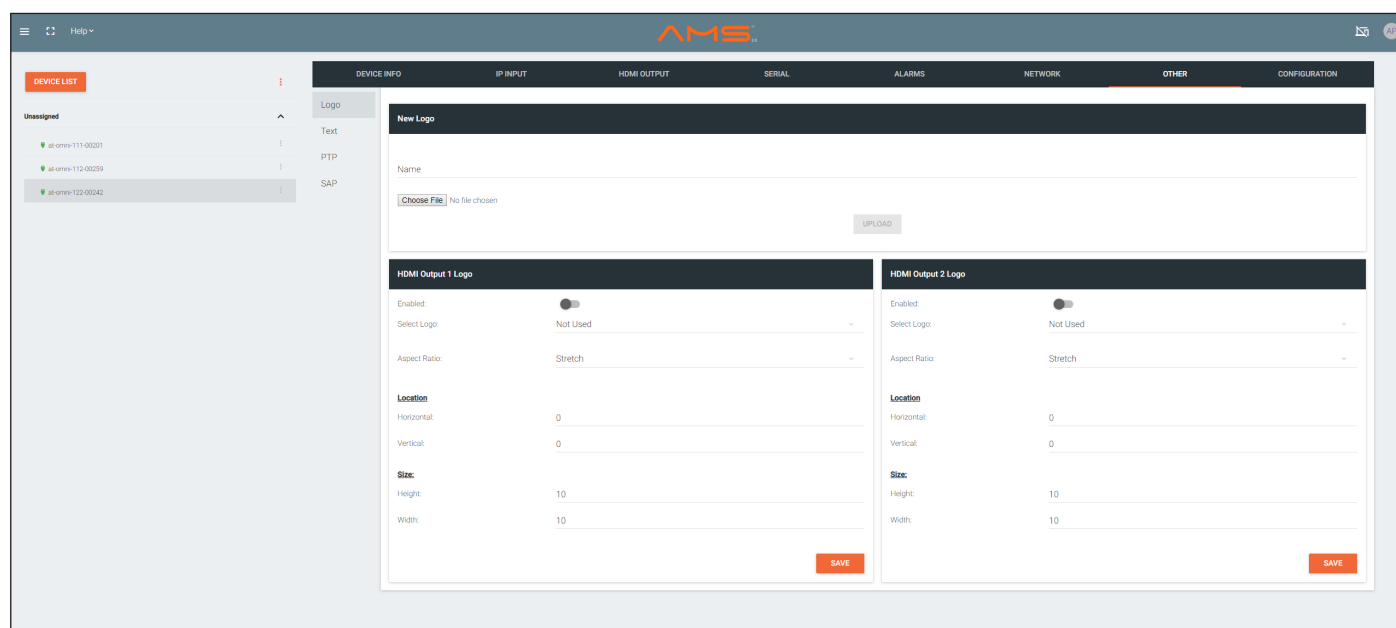

Name

Enter a name for the logo in this field.

Choose File

Click this button to select the logo file to be uploaded. Files must be in .png format and must not exceed 5 MB (5120000 bytes) in size. When an image file is uploaded, it will appear in the **Logo** drop-down list.

UPLOAD

Click this button to upload the logo file to the encoder.

Enabled

Click the toggle switch to enable or disable the logo. If the toggle switch is green, then the logo will be enabled.

Target

The name used by AMS to identify the encoder.

Select Logo

Click this drop-down list to select the desired logo. To disable the use of a logo, set to **Not Used**.

Aspect Ratio

Click this drop-down list to select the type of aspect ratio to be applied to the logo.

Horizontal

Enter the horizontal position of the logo on the screen.

Vertical

Enter the vertical position of the logo on the screen.

Height

Enter the horizontal resolution of the logo, in pixels.

Width

Enter the vertical resolution of the logo, in pixels.



IMPORTANT: Maximum logo resolution (both height and width) is 1/4 of the video resolution.

Text

The **Text** page provides the ability to display scrolling or stationary text superimposed on the source image. Refer to [Text Insertion \(page 35\)](#) for more information.

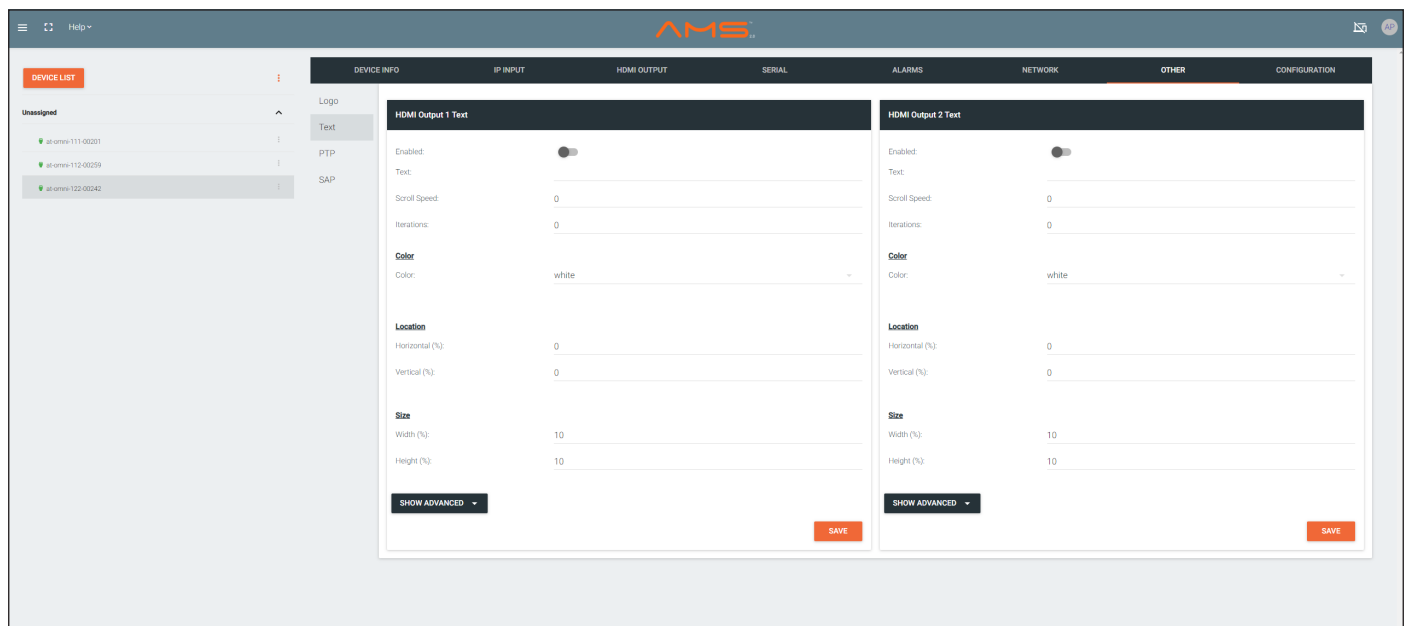

Enabled

Click this toggle switch to enable or disable the text. When the toggle switch is green, the text will be enabled.

Text

Enter the desired text in this field.

Scroll Speed

Enter the scrolling speed in this field. Values from -255 to 255 are valid. Negative numbers will scroll the text from left to right. Positive numbers will scroll text from right to left.

Iterations

Enter the number of iterations in the **Iteration** field. Set this field to 0 (zero) to set the number of iterations to infinity.

Color

Click this drop-down list to select a solid color preset: **red, green, black, white, yellow, or blue.**

Horizontal (%), Vertical (%)

Specify the location of the text in the Horizontal (%) and Vertical (%) fields. Each of these values is based on the horizontal and vertical resolution of the screen.

Width (%), Height (%)

Specify the size of the text in the Width (%) and Height (%) fields. Each of these values is based on the horizontal and vertical resolution of the screen.

Advanced Settings

Click the **SHOW ADVANCED** button to view the following options.

Red, Green, Blue, Alpha

Enter the RGBA values for each of the respective fields, to specify a custom color and transparency of the text. Enter the desired value in the Alpha field to control the transparency of the text. A value of 255 is opaque and a value of 0 is transparent. Numbers from 0 to 255 are valid for each of these fields.

PTP

The **PTP** page provides options for adjust Precision Time Protocol (PTP) for AES67 audio streams. PTP is used by AES67 to keep all audio streams synchronized.

For a system utilizing PTP, all devices undergo an automatic self-election process to choose the interface to be used as the PTP grandmaster (GM) clock, based on the accuracy of the device's clock and the device's configured priority. A lower priority number means the unit is more likely to get selected as GM.



IMPORTANT: If a new device is added to the network and the GM changes, a brief outage will be experienced while all connected devices synchronize with the new clock. Because of this, Atlona recommends that one unit gets manually defined as the GM and have both **Priority 1** and **Priority 2** fields be set to 1.

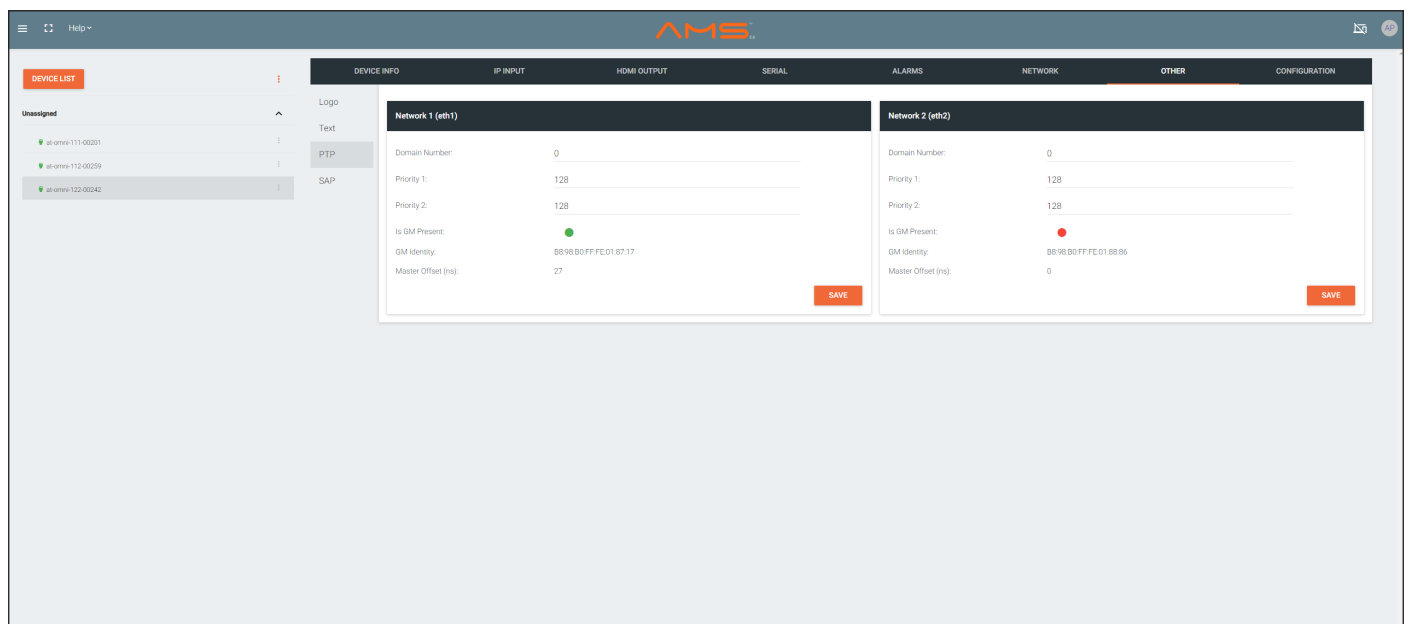

Domain Number

Enter the domain number in this field. Valid entries are 0 through 127.

Priority 1

Enter the priority number in this field.

Priority 2

Enter the priority number in this field.

Is GM Present

This indicator displays the existence of a grandmaster clock for the specified PTP domain number. If the indicator is green, then the grandmaster clock exists on this interface.

GM Identity

The grandmaster clock identity. If this field is blank, then it means that this interface is the grandmaster clock.

Master Offset

Displays the grandmaster clock offset.

SAP

The **SAP** page enables or disables the Session Announcement Protocol protocol. Enabling SAP configures the decoder to look for SAP messages from encoders on the network that are configured to send SAP. Any messages that are discovered will be displayed here.

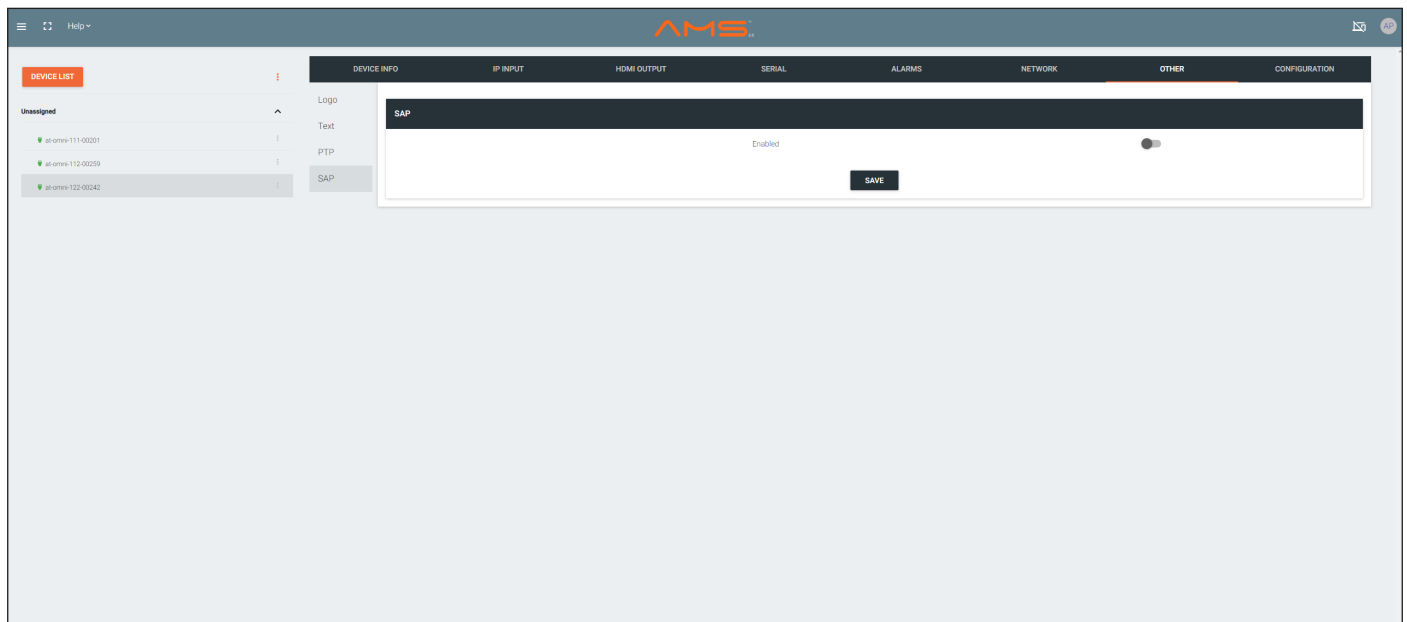

Enable

Click this toggle switch to enable or disable SAP. If enabled, the toggle switch will be green. Click the **SAVE** button to commit changes.

The Virtual Matrix

1. Click the ☰ icon, in the upper-left corner of the AMS Dashboard.
2. Click **Virtual Matrix**.

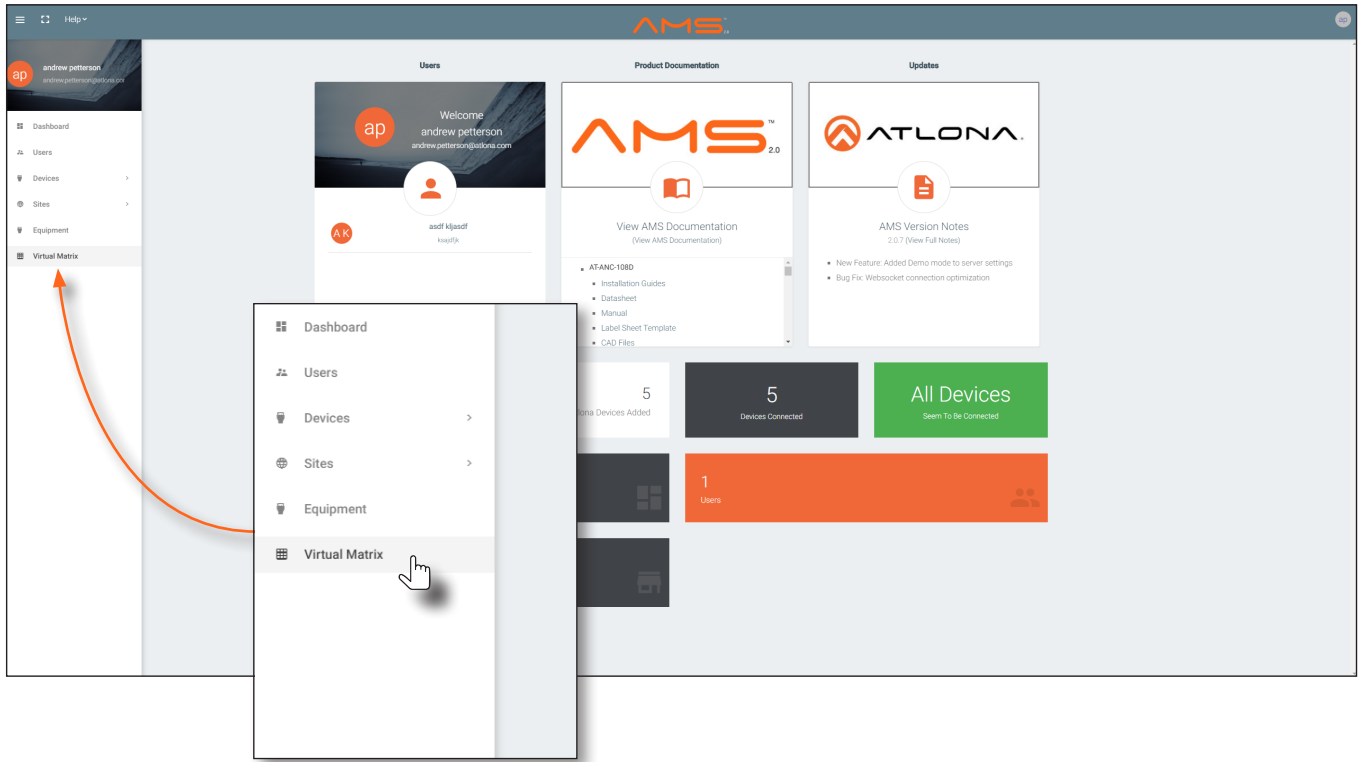

3. The **OmniStream Virtual Matrix** page will be displayed.



The screenshot shows the 'OmniStream Virtual Matrix' page. The page title is 'OmniStream Virtual Matrix' and it is for 'All Sites'. The page displays a grid of device connections. The columns represent different device models and their IP addresses, and the rows represent different sites. The grid shows the connection status for each device at each site. A legend at the top left indicates the connection status: 'Connected' (green checkmark) and 'Options' (orange button). The grid shows that several devices are connected to various sites, with some devices having 'Options' buttons next to them.

Encoders / Decoders	AT-OMNI-122 192.168.11.181	Connected	AT-OMNI-121 192.168.11.184	Connected	AT-OMNI-122 192.168.11.86	Connected	AT-OMNI-521 192.168.11.39	Connected	AT-OMNI-122 192.168.11.166	Connected	AT-OMNI-121 192.168.11.165	Connected
192.168.11.89 192.168.11.88 at omni 122-00349 Connected	HDMI 1	Connected	HDMI 1	Connected	HDMI 1	Connected	HDMI 1	Connected	HDMI 1	Connected	HDMI 1	Connected
192.168.11.50 at omni 111-00200 Connected	HDMI 1	Connected	HDMI 1	Connected	HDMI 1	Connected	HDMI 1	Connected	HDMI 1	Connected	HDMI 1	Connected
192.168.11.51 at omni 512-00000 Connected	HDMI 1	Connected	HDMI 1	Connected	HDMI 1	Connected	HDMI 1	Connected	HDMI 1	Connected	HDMI 1	Connected
192.168.11.116 at omni 112-00722 Connected	HDMI 1	Connected	HDMI 1	Connected	HDMI 1	Connected	HDMI 1	Connected	HDMI 1	Connected	HDMI 1	Connected
192.168.11.183 192.168.11.148 at omni 112-00000 Connected	HDMI 1	Connected	HDMI 1	Connected	HDMI 1	Connected	HDMI 1	Connected	HDMI 1	Connected	HDMI 1	Connected
192.168.11.167 at omni 111-00200 Connected	HDMI 1	Connected	HDMI 1	Connected	HDMI 1	Connected	HDMI 1	Connected	HDMI 1	Connected	HDMI 1	Connected

Layout and Operation

The illustration below, shows a multiple OmniStream units (encoders and decoders). The Virtual Matrix is organized into rows and columns.

The blue circle with the checkmark indicates that these two OmniStream units are connected to one another. The second column identifies a dual-channel decoder (AT-OMNI-122). The third row shows a dual-channel encoder (AT-OMNI-112). In this example, the source signal on **HDMI 1 IN** (encoder) is being sent out, over the network, and will be displayed on **HDMI 1** on the decoder. This will create a *cross-connection*, which connects both the encoder and decoder together.



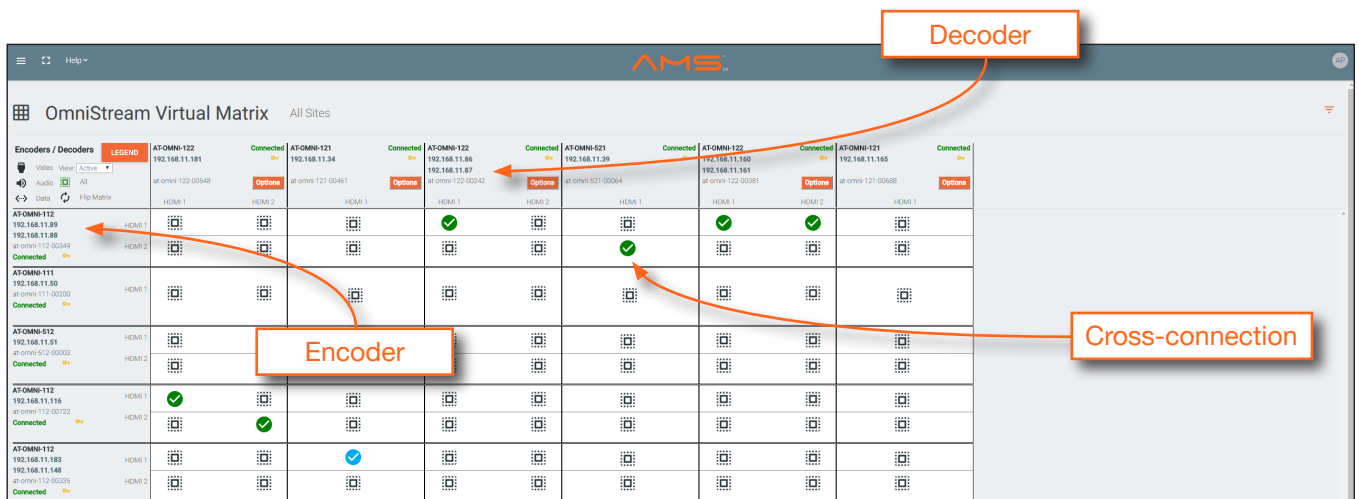

- Creating a cross-connection**
 To route an input on an encoder to an output, locate the row and column where an input and output intersect, then click the square with the dots around it.
- Removing a cross-connection**
 To remove a *cross-connection*, click on the desired circle icon with the check mark symbol. The square with the dots around it will be displayed indicating that the *cross-connection* has been removed.

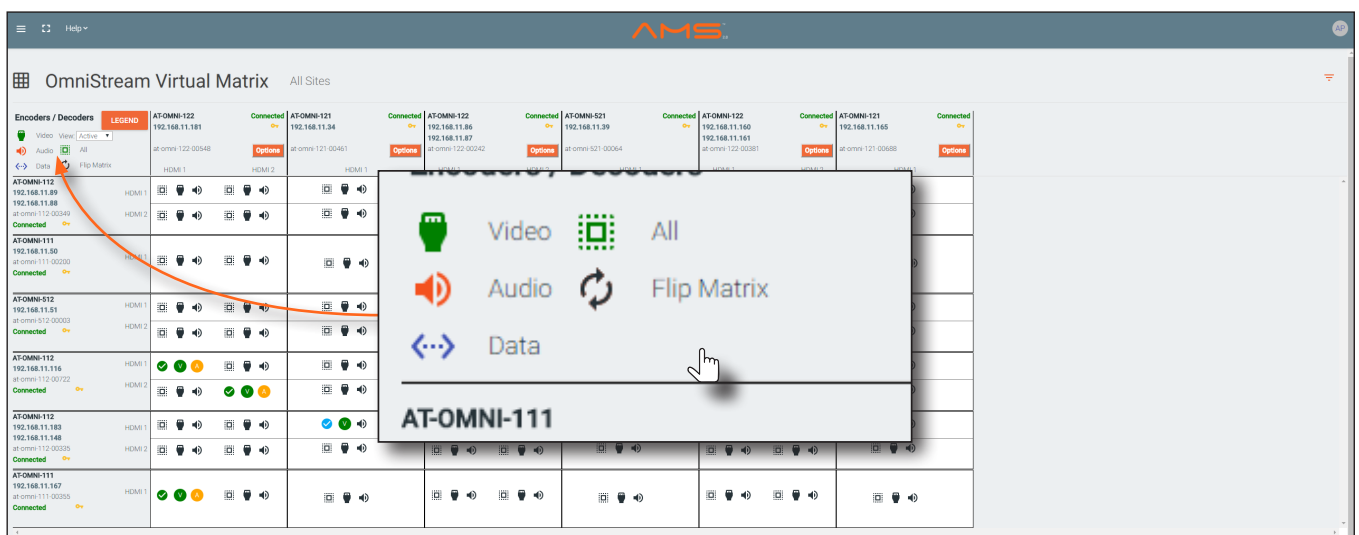

- To view the individual streams for video, audio, and data, click the icons on the upper-left corner of the screen.



When these icons are clicked, the associated icons will be displayed in the rows and columns of the Virtual Matrix.

Symbol	Description
	Video only
	Audio only
	Data only
	Connected; not all signals are active
	Connected; all streams are being used

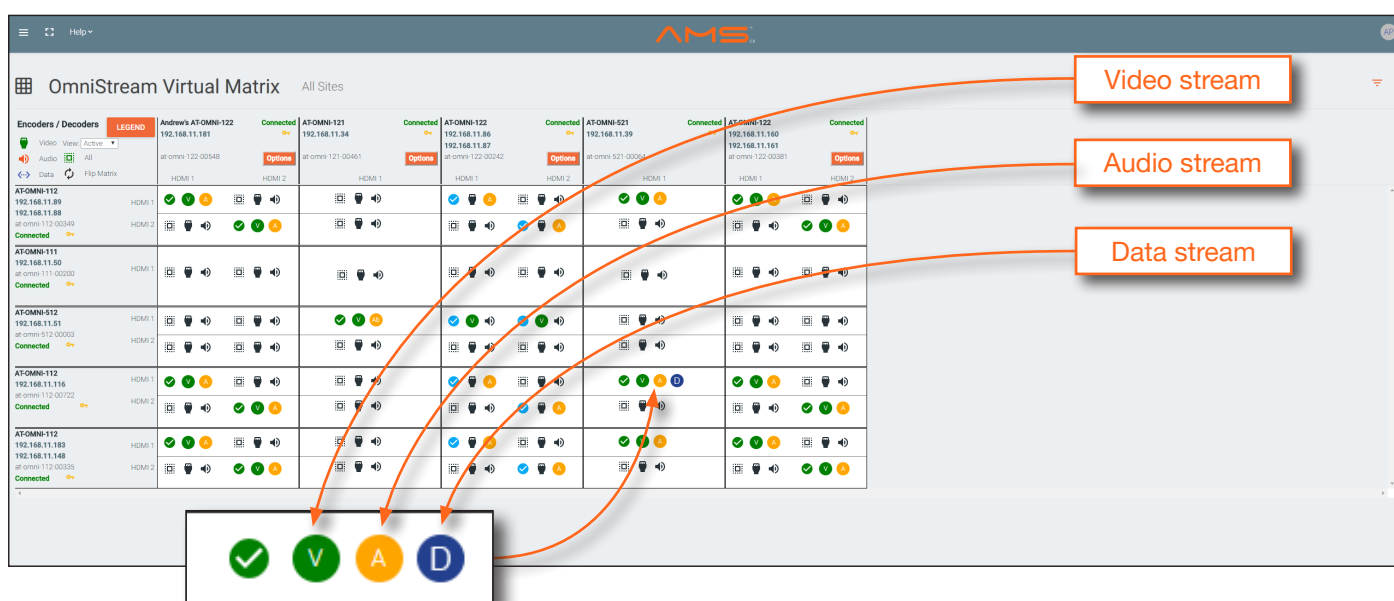

IMPORTANT: R-Type and Pro compatibility: R-Type encoders (AT-OMNI-512) and decoders (AT-OMNI-521) operate in Video Mode, only. Pro encoders can be set to either Video Mode or PC Mode. Video Mode is incompatible with PC Mode. Therefore, in order for both R-Type and Pro encoders/decoders to work within a system, Pro encoders/decoders must be set to Video Mode. Refer to [Setting the Video Mode \(page 30\)](#) for more information.

- Click the **Video**, **Audio**, and **Data** icons to return to the normal view.
- Since only HDMI (both audio and video) is being used, the V (video) and A (audio) icons are displayed. The blue circle with the checkmark indicates that the cross-section has been created. However, not all streams are being used. Refer to the chart below.
- This illustration also shows that the data stream (the icon with two arrows and three dots), which is used for control, is also being used and is displayed as a dark-blue circle with the letter “D”.
- The icons in the upper-left corner can also act as a filter. This allows for a clear breakdown of where signals are being routed and is useful when several encoders and decoders are used on a network.

Web Server

Accessing the Web Server

In order to access the web server of the desired encoder/decoder, the IP address of the encoder must be known. This can be accomplished by more than one method. Running IP scanner software or using the Address Resolution Protocol (ARP) are two possibilities. When running an IP scanner or using ARP, both the computer and the OmniStream encoders/decoders must be connected to the same network.



TIP: Atlona recommends downloading and using the Network Assignment Planner, when setting up OmniStream products on the network. Recording this information in this document will provide a “snapshot” of the current OmniStream network configuration. The Network Assignment Planner is available for download on the OmniStream product pages, under the Resources tab.

Getting the IP Address

The following method uses the `arp` command, which is available from the command line in Windows. The `arp` command will display the IP-to-physical address translation tables used by the Address Resolution Protocol (ARP). The following procedure can be used for both encoders and decoders.

1. Identify the desired encoder/decoder by locating the MAC address on the bottom of the unit. *Figure 1.1* shows a sample label from an AT-OMNI-112 dual-channel encoder.

The MAC address for the Ethernet 1 physical interface is B8:98:B0:01:F7:EB.

Figure 1.1 - Sample label on the bottom of a dual-channel encoder.

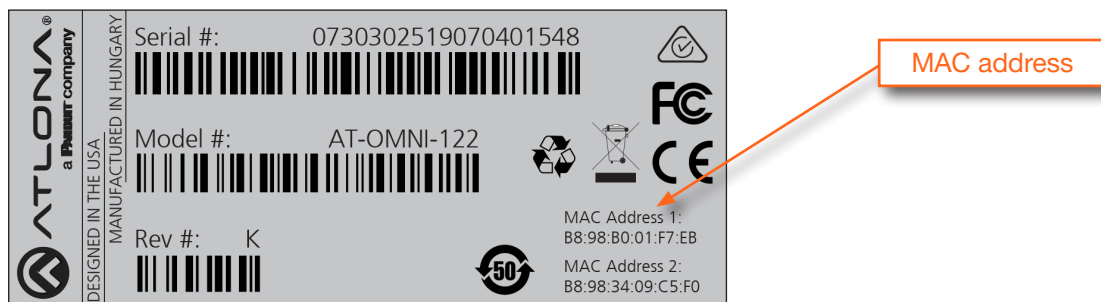

NOTE: Dual-channel decoders have two Ethernet interfaces and two MAC addresses:

Ethernet 1 = MAC address 1
 Ethernet 2 = MAC address 2

Therefore, if *both* physical interfaces are connected to the network, the decoder will have two IP addresses. However, the same decoder can be accessed through either IP address.

2. Connect a PC to the same network where the OmniStream encoders/decoders are connected.
3. Type `cmd` in the search bar, then press [ENTER] to launch the command line interface.

- At the command prompt, type `arp -a`. Make sure to include a space between `arp` and the `-a` argument, then press [ENTER].
- Press [ENTER]. Several lines of information will be displayed. Locate the MAC address of the encoder/decoder, under the **Physical Address** column. Directly across from the MAC address, the IP address of the encoder/decoder will be listed under the **Internet Address** column.

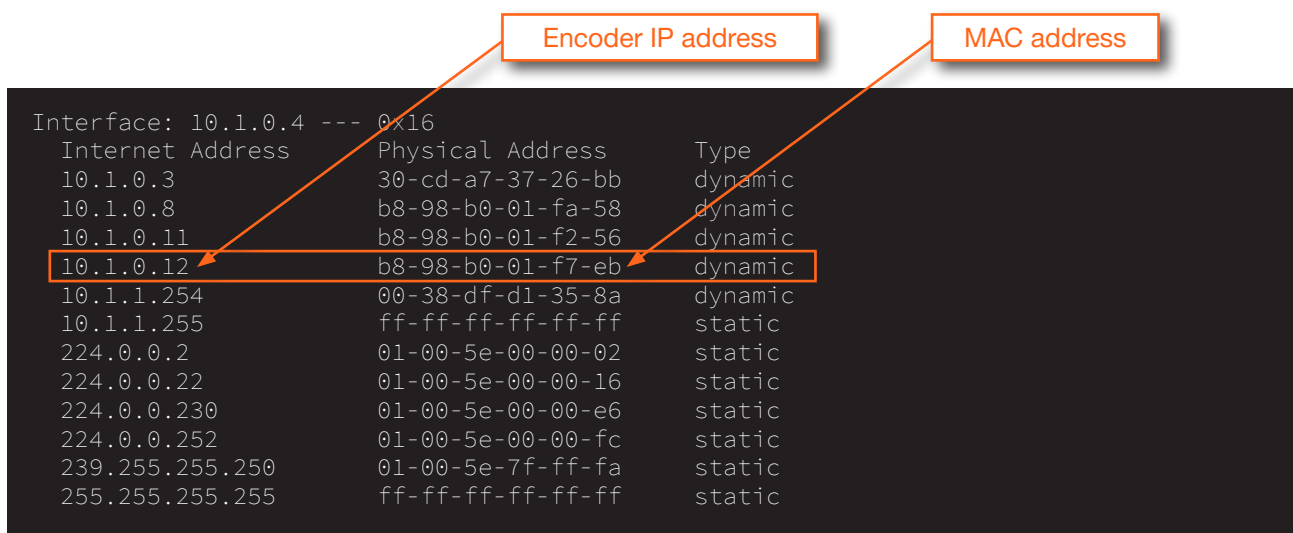

```

Interface: 10.1.0.4 --- 0x16
Internet Address      Physical Address      Type
10.1.0.3             30-cd-a7-37-26-bb    dynamic
10.1.0.8             b8-98-b0-01-fa-58    dynamic
10.1.0.11            b8-98-b0-01-f2-56    dynamic
10.1.0.12            b8-98-b0-01-f7-eb    dynamic
10.1.1.254           00-38-df-d1-35-8a    dynamic
10.1.1.255           ff-ff-ff-ff-ff-ff    static
224.0.0.2            01-00-5e-00-00-02    static
224.0.0.22           01-00-5e-00-00-16    static
224.0.0.230          01-00-5e-00-00-e6    static
224.0.0.252          01-00-5e-00-00-fc    static
239.255.255.250      01-00-5e-7f-ff-fa    static
255.255.255.255      ff-ff-ff-ff-ff-ff    static
  
```

Logging In

- Launch the desired web browser and enter the IP address of the encoder in the address bar.
- Enter the username and password. Note that the password field will always be masked. The default credentials are:

Username: admin
 Password: Atlona

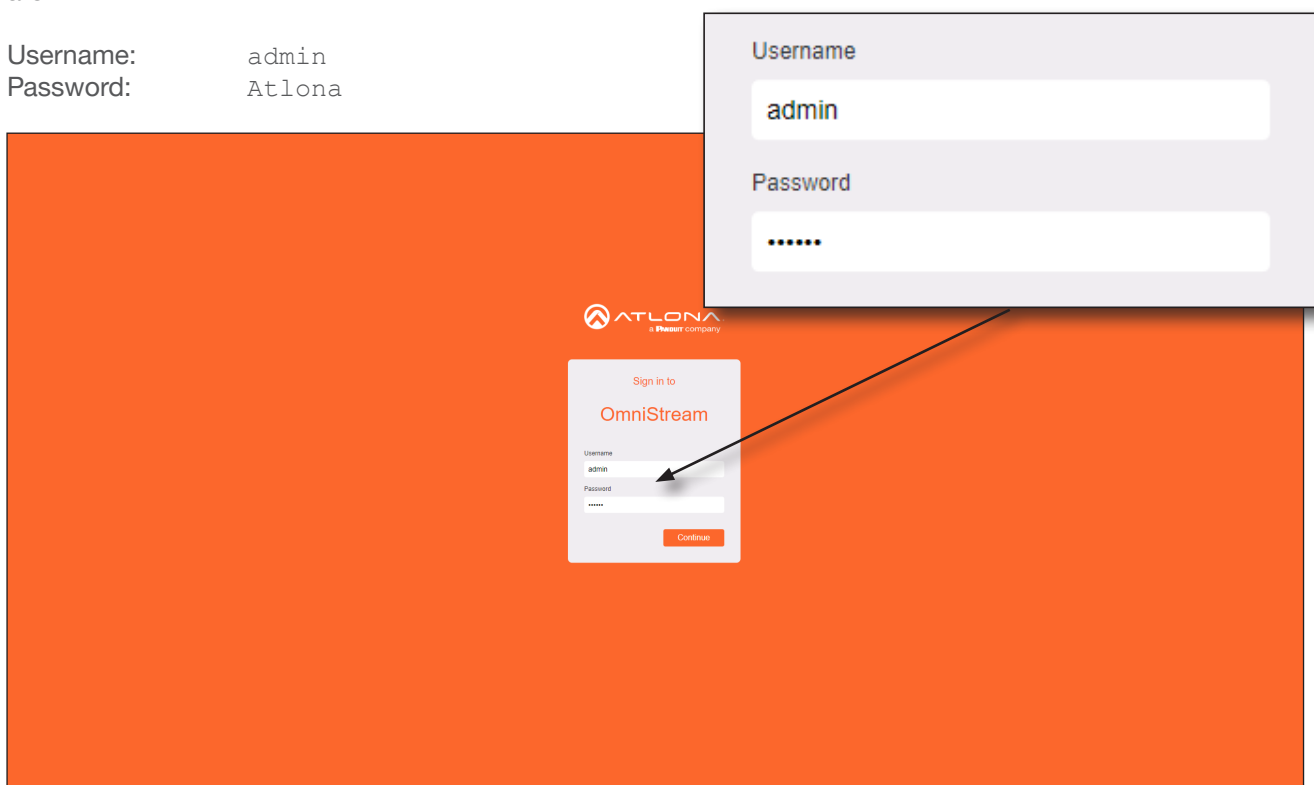

3. The **System Information** page will be displayed.

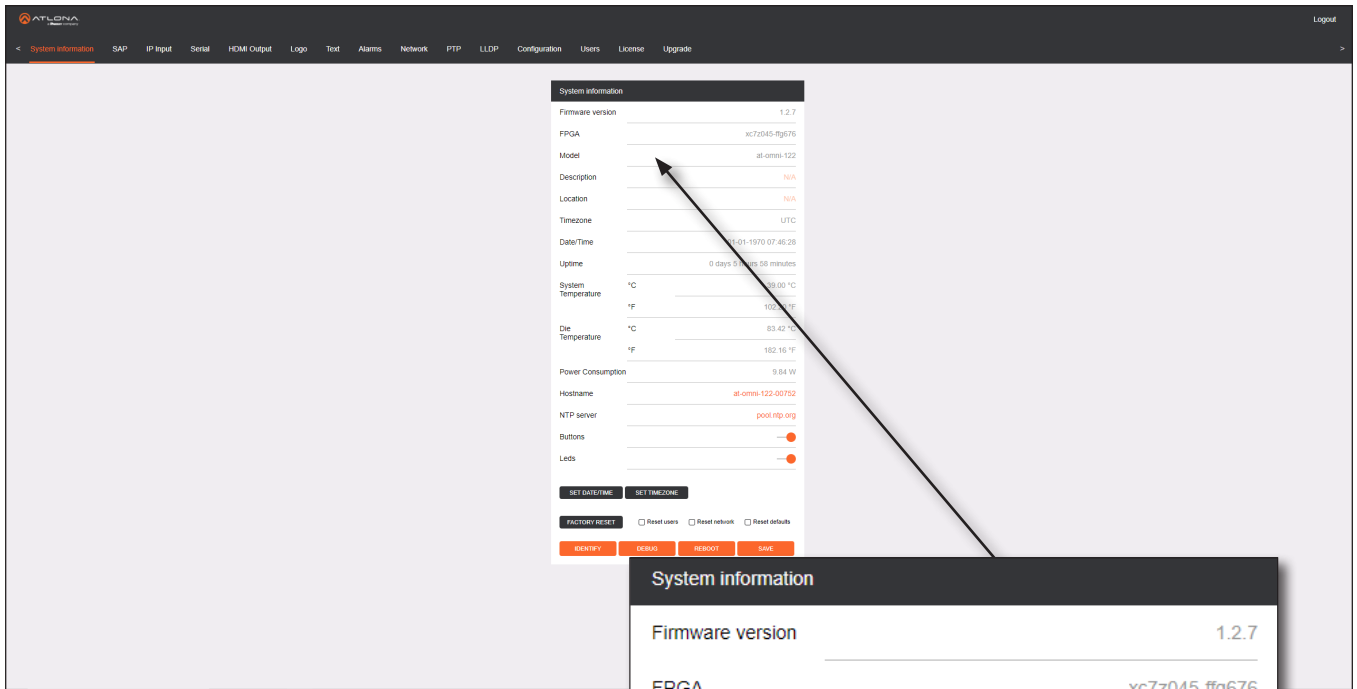

4. The login process is complete.

System information

Firmware version	1.2.7
FPGA	xc7z045-fpg676
Model	at-omni-122
Description	N/A
Location	N/A
Timezone	UTC
Date/Time	01-01-1970 07:46:28
Uptime	0 days 5 hours 58 minutes
System Temperature	°C 39.00 °C
	°F 102.20 °F
Die Temperature	°C 83.42 °C
	°F 182.16 °F
Power Consumption	9.84 W
Hostname	at-omni-122-00752
NTP server	pool.ntp.org
Buttons	— ●
Leds	— ●

SET DATE/TIME
SET TIMEZONE

FACTORY RESET
 Reset users
 Reset network
 Reset defaults

System information page

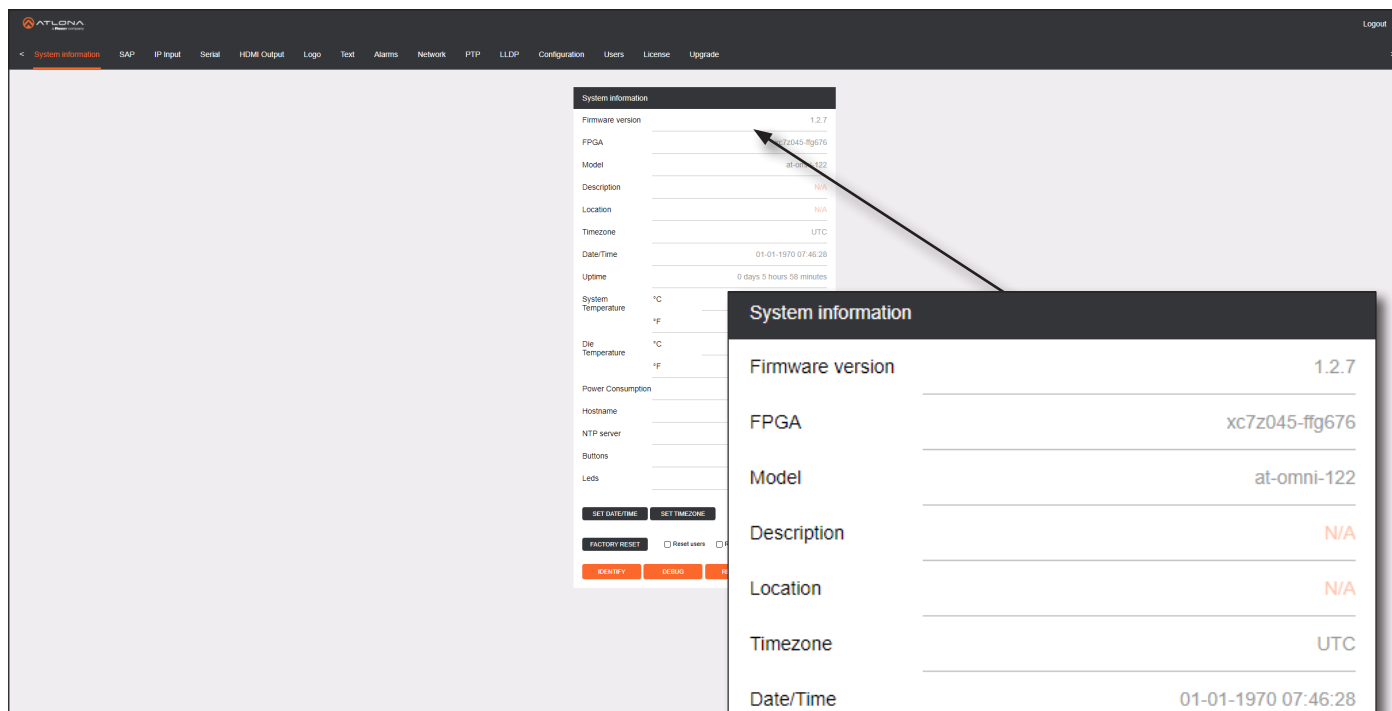
Firmware version

The version of firmware that the decoder is running. Always make sure the latest version of firmware is installed.

FPGA

Displays the FPGA model number and the size.

Model

The model number of the unit.

Model	Description
AT-OMNI-121	Single-channel decoder
AT-OMNI-122	Dual-channel decoder

Description

Provides the option of assigning descriptive name to the unit.

Location

Provides the option of assigning a description of where the unit is located.

Timezone

Displays the time zone format. Click the **SET TIMEZONE** button, to assign the time zone.

Date/Time

Displays the current date and time. Click the **SET DATE/TIME** button to set these values.

System information

Firmware version 1.2.7

FPGA xc7z045-ffg676

Model at-omni-122

Description N/A

Location N/A

Timezone UTC

Date/Time 01-01-1970 07:46:28

Uptime 0 days 5 hours 58 minutes

System Temperature °C 39.00 °C
°F 102.20 °F

Die Temperature °C 83.42 °C
°F 182.16 °F

Power Consumption 9.84 W

Hostname at-omni-122-00752

NTP server pool.ntp.org

Buttons

Leds

SET DATE/TIME **SET TIMEZONE**

FACTORY RESET Reset users Reset network Reset defaults

IDENTIFY **DEBUG** **REBOOT** **SAVE**

Uptime

Displays the elapsed time since the unit was powered-on or rebooted.

System Temperature

Displays the ambient enclosure temperature.

Die Temperature

Displays the value returned from the die temperature sensor (DTS) on the chip of the PCB.

Power Consumption

Displays the precise power consumption of the encoder.

Hostname

Displays the hostname of the encoder. By default, OmniStream encoders are assigned a default hostname, which is constructed as follows: at-omni-[SKU]-[last five digits of MAC address]. If using a custom hostname, it must meet the hostname standards, defined here: <https://tools.ietf.org/html/rfc1123>.

NTP Server

Displays the NTP server (if used). Click this field to enter the desired NTP server address.

Buttons

Click this toggle switch to enable or disable the button backlight indicators on the front-panel.

LEDs

Click this toggle switch to enable or disable all front-panel LED indicators and button backlight indicators.

SET DATE/TIME

Click this button to set the current date and time.

SET TIMEZONE

Click this button to set the desired time zone.

FACTORY RESET

Click this button to reset the encoder to factory-default settings. When performing a factory reset, the following options can be selected, by clicking the check box. If no options are selected, then the encoder is reset with no factory-default settings.

Option	Description
None Checked	Resets the encoder with no factory-default settings.
Reset User	Resets the encoder to factory-default settings and resets custom user information.
Reset Network	Resets the encoder to factory-default settings and resets network information.
Reset Defaults	Resets the encoder to factory-default settings. In addition, static multicast addresses are configured. This option can be used to configure a single encoder to transmit to any number of decoders without using the Virtual Matrix within AMS.
	 IMPORTANT: This option will not work for multiple encoders on the same network.

IDENTIFY

Click this button to physically identify a unit on the network. Clicking this button will cause all front-panel LED indicators to flash for 10 seconds.

DEBUG

Click this button to instruct the unit to create a debug file. This file is used by Atlona Technical Support Engineers to diagnose internal issues with the unit.

REBOOT

Click this button to perform a soft reboot of the encoder.

SAVE

Click this button to commit changes to the settings on this page.

SAP page

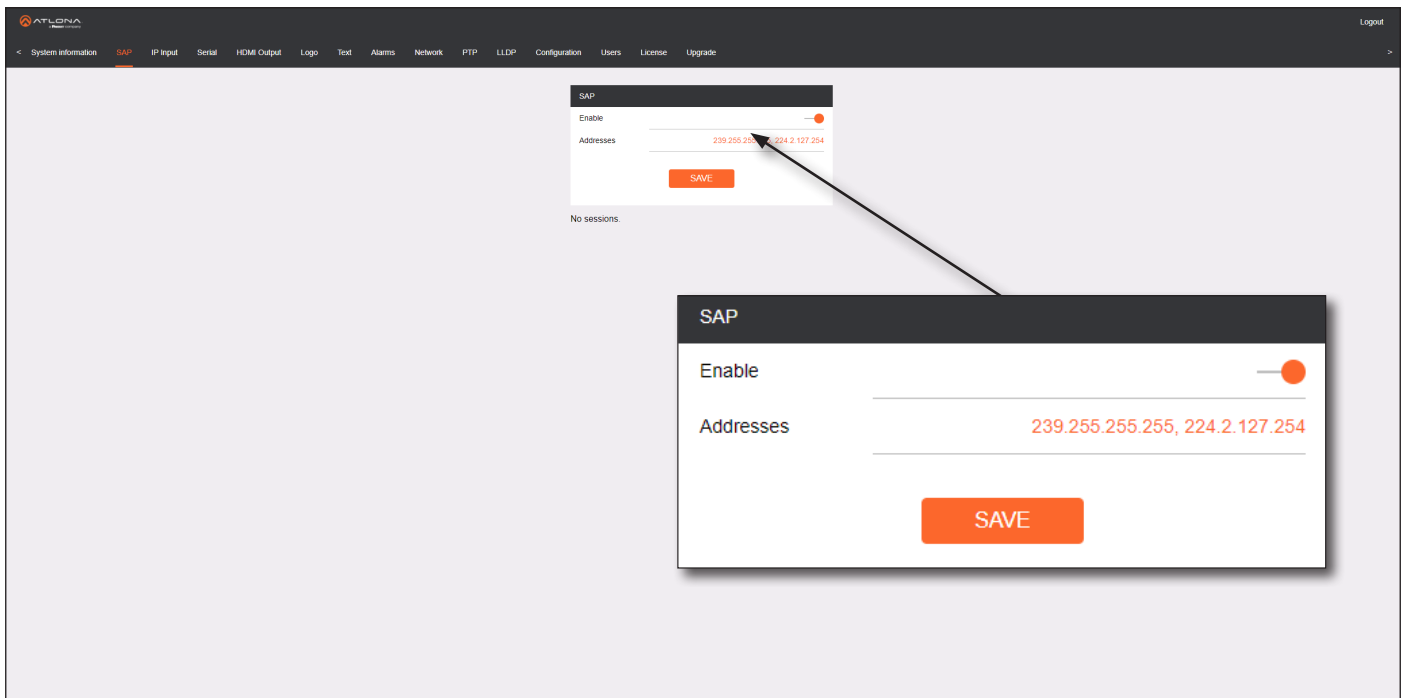

Enable

Click this toggle to enable or disable SAP. This feature is enabled when the toggle switch is orange. This is the default setting.

Addresses

Encoders currently send SAP announcements on two multicast addresses: 224.2.127.254 and 239.255.255.255. In some rare instances, this can conflict with other network address settings. Custom SAP addresses can be specified in this field.



NOTE: If the **Addresses** field is changed, then the same changes must be applied to all devices, in order for all devices to see the SAP multicast.

IP Input page

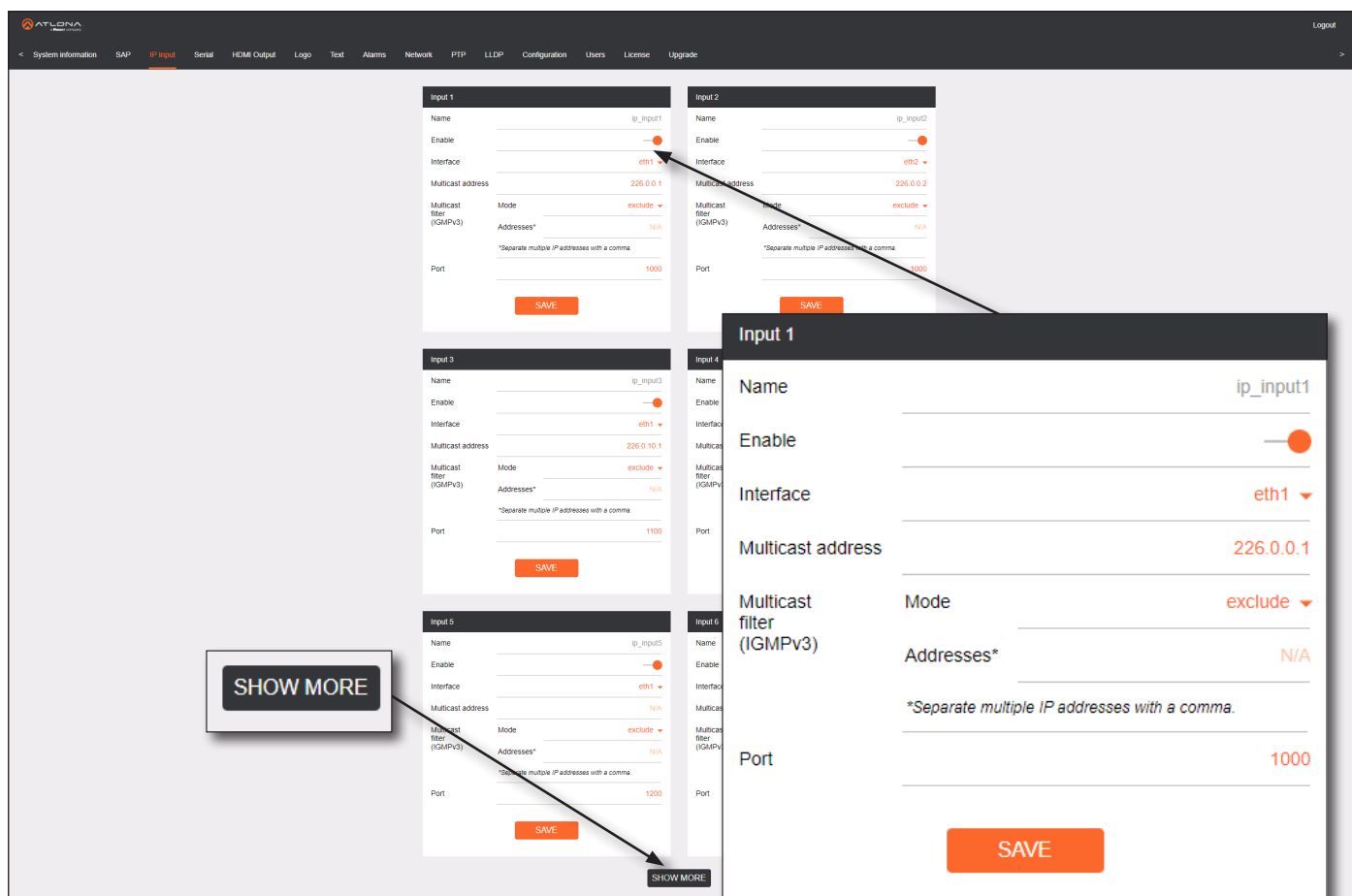

Input window groups

The following fields apply to all **Input** window groups. Dual-channel decoders only have a total of twelve **Input** window groups. Single-channel decoders only have five **Input** window groups.

Name

The name of the input. This field cannot be changed.

Enable

Click this toggle switch to enable or disable the IP input.

Interface

Click this drop-down list to select the desired Ethernet interface.

Multicast address

Enter the multicast IP address of the subscribed encoder in this field.

Multicast filter (IGMPv3) > Mode

Click this drop-down list to select the multicast filtering mode. Available options are **exclude** or **include**.

Multicast filter (IGMPv3) > Addresses

Enter the desired address(es) in this field. Separate multiple multicast IP addresses with a comma delimiter.

Port

Enter the port number of the subscribed encoder in this field.

SAVE

Click this button to commit all changes in the **Input** window group.

SHOW MORE

Click this button to expand the list of available Input window groups. This button is only available on dual-channel decoders.

Serial page

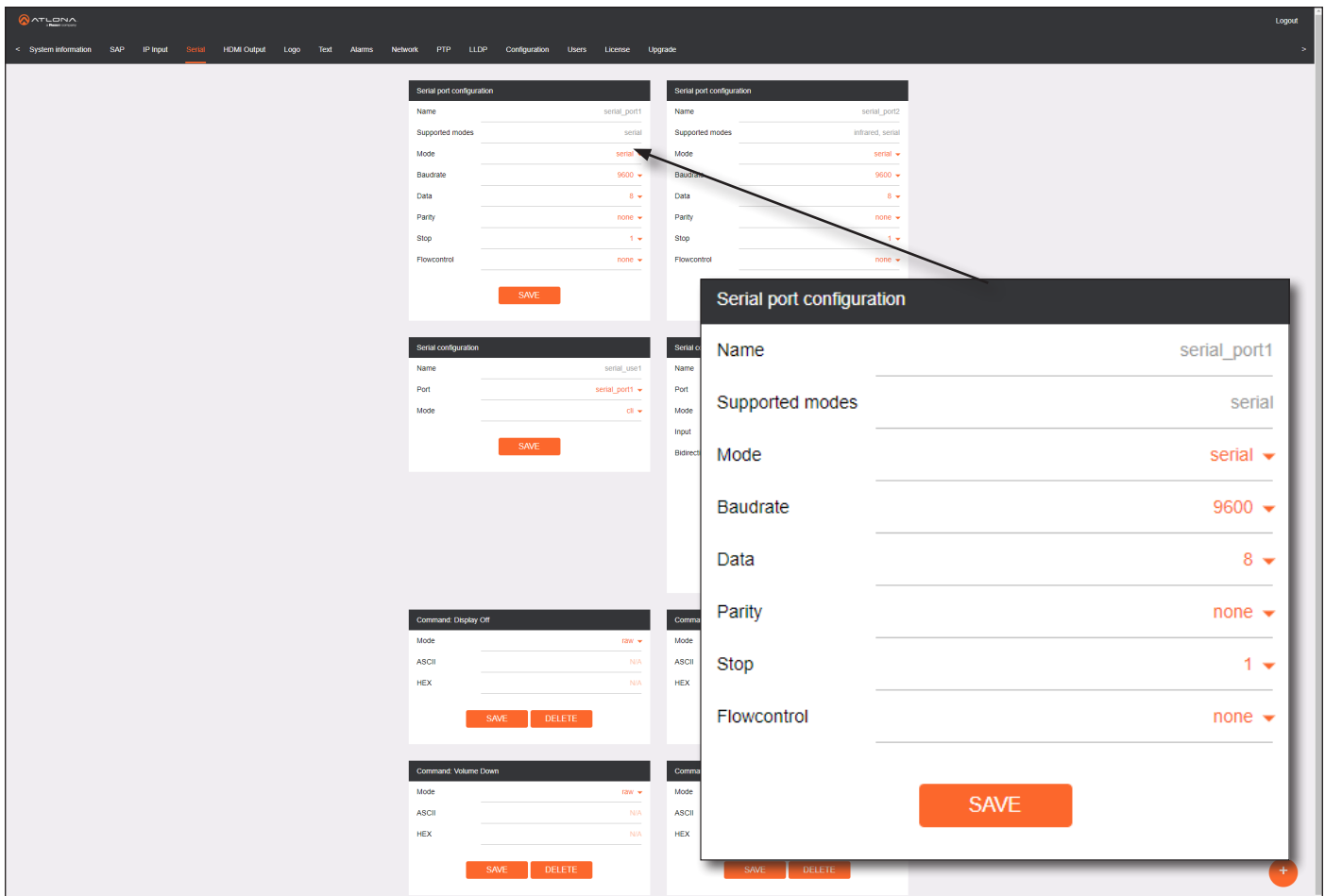

Serial port configuration window groups

The following fields apply to both **Serial port configuration** window groups. Dual-channel decoders support serial mode on port 1 and both serial and IR on port 2. Single-channel decoders only support infrared on port 2.

Name

The name of the serial port. This field cannot be changed.

Supported Modes

Displays the supported protocols for the serial port. This field cannot be changed.

Mode

Click this drop-down list to select the desired serial mode. Available values will be reflected in the **Supported Modes** field.

Baudrate

Click this drop-down list to select the desired baud rate: **115200, 57600, 38400, 19200, or 9600.**

Data

Click this drop-down list to select the number of data bits: **6, 7, or 8.**

Parity

Click this drop-down list to select the parity bit: **None, Odd, Even, Mark, or Space.**

Stop

Click this drop-down list to select the stop bit: **1, 1.5, or 2.**

Flow Control

Click this drop-down list to select the type of flow control: **none, xonxoff, or hw.**

SAVE

Click this button to commit all changes within the **Serial port configuration** window group.

Serial configuration window groups

The following fields apply to both **Serial configuration** window groups.

Name

The name of the port. This field cannot be changed.

Port

Click this drop-down list to select the desired serial port.

Mode

Click this drop-down list to select the desired control mode. Available values are: **cli** and **tcpproxy**. Select **tcpproxy** to send IP commands directly to the decoder, which are then output over RS-232 to the display (sink) device. Selecting the **cli** option will pass through RS-232 data, directly from a control system, to the sink device that is connected to the decoder.

SAVE

Click this button to commit all changes within the **Serial configuration** window group.

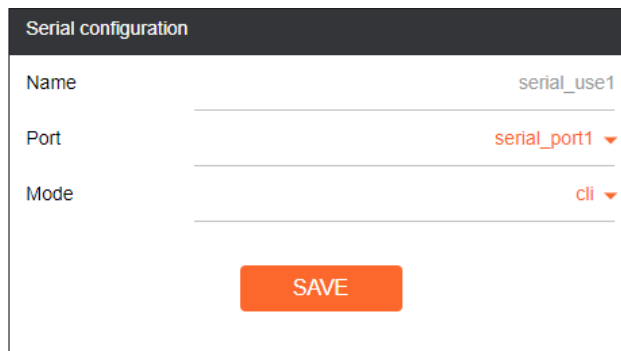

Serial configuration	
Name	serial_use1
Port	serial_port1 ▼
Mode	cli ▼
<input type="button" value="SAVE"/>	

Command window groups

By default, window groups for the following commands are created: **Display Off**, **Display On**, **Volume Down**, and **Volume Up**.

Interpret on

Click this drop-down list to select the endpoint where the command will be processed: **encoder** or **decoder**.

ASCII

Enter the ASCII representation of the command string in this field.

HEX

Enter the hexadecimal representation of the command in this field.

SAVE

Click this button to commit all changes within the **Command** window group.

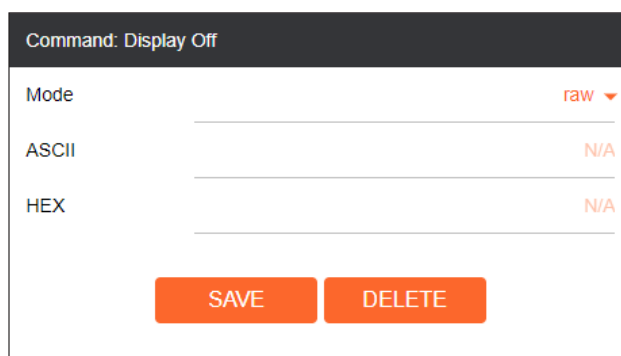

Command: Display Off	
Mode	raw ▼
ASCII	N/A
HEX	N/A
<input type="button" value="SAVE"/> <input type="button" value="DELETE"/>	



NOTE: When entering the command string, it is not required to enter the string under both the ASCII and HEX fields. The encoder requires that one field be completed.



New Command

Click this button to create a new command window group. Provide a name for the command in the displayed dialog box, then click the **Create** button. Complete each of the fields, as described above.

HDMI Output page

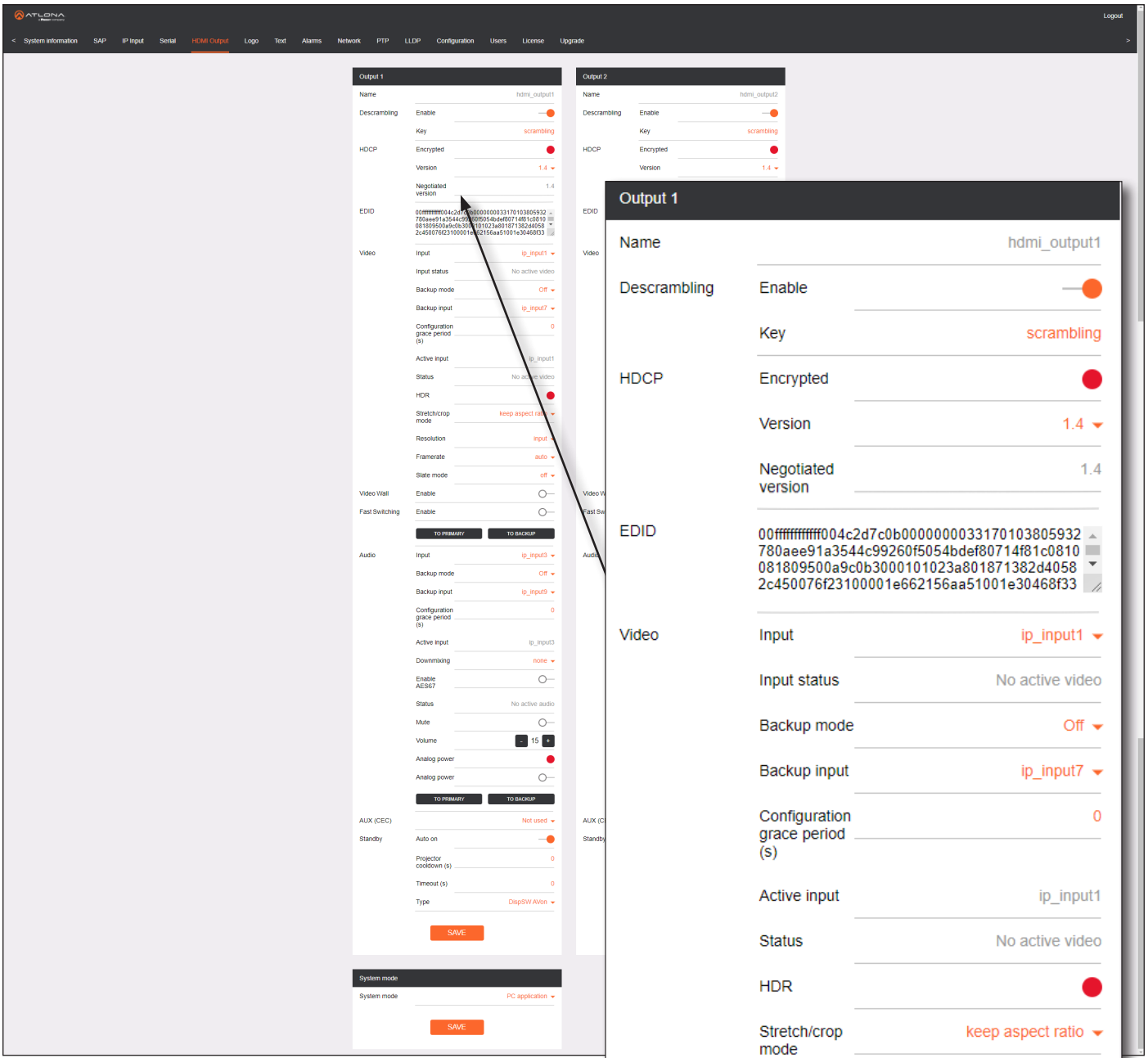

Output window groups

The following fields apply to both **Output** window groups. Single-channel decoders only have one **Output** window group.

Name

The name of the output port. This field cannot be changed.

Enable

Click this toggle switch to enable or disable scrambling. If a scrambling key is used on the subscribed encoder, then descrambling must be enabled on the decoder in order for the source signal to reach the sink device.

Key

Enter the descrambling key in this field. This key must match the scrambling key on the subscribed encoder.

Encrypted

This indicator will be green if the stream content is HDCP-encrypted.

Version

Click this drop-down list to select the supported version of HDCP.

Negotiated

Displays the version of HDCP used by the stream.

EDID

This field will display the EDID of the connected display. This raw data can be copied and stored under the EDID page, if desired.

Input



Click this drop-down list to select the desired IP input. Available options are ip_input1 - ip_input12, none, and generator.

Input status

Displays the input status. If no video stream is detected, then “No active video” will be displayed.

Backup mode

Click this drop-down list to select the backup mode. Both Video and Audio provide the Backup Mode feature.

HDCP	Encrypted	
	Version	1.4 ▼
	Negotiated version	1.4
EDID	<pre>00ffffffff004c2d7c0b0000000033170103805932 780aee91a3544c99260f5054bdef80714f81c0810 081809500a9c0b3000101023a801871382d4058 2c450076f23100001e662156aa51001e30468f33</pre>	
Video	Input	ip_input1 ▼
	Input status	No active video
	Backup mode	Off ▼
	Backup input	ip_input7 ▼
	Configuration grace period (s)	0
	Active input	ip_input1
	Status	No active video
	HDR	

Mode	Description
Off	Backup source is disabled; join request not sent.
Join Active	The decoder sends a join request only when the decoder decides to switch between video sources. Switch time will not exceed 5 seconds.
Join Always	The decoder always joins to the backup video source. Switch time will not exceed 0.5 seconds.

Backup Input

Select the secondary video backup IP input from this drop-down list. If the primary IP input is down, then the decoder will automatically switch to this input. Refer to the **Backup Mode** option, above, for setting the conditions for switching inputs. Both Video and Audio provide the Backup Input feature.

Configuration Grace Period

To prevent the decoder from automatically making the redundancy switch, when redundancy is enabled, a grace period can be entered. By default, the grace period is set to zero seconds. If set to zero seconds, automatic failover will occur, if the stream is interrupted for any reason. Refer to [Configuring Redundant Streams \(page 111\)](#) for more information.

Active Input

Displays the active video input.

Status

Displays the active video input. If no input is active or detected, then this field will display “No active video”.

HDR

This indicator will be green if HDR video is present.

Stretch / Crop Mode

Click this drop-down list to select the aspect ratio.

Mode	Description
Keep Aspect Ratio	Aspect ratio is preserved; the output on the decoder will be the same as the input on the encoder.
Full Screen	Stretches the image to fill the screen. In some cases this can distort (“stretch”) the image.
16:9	Sets the aspect ratio to 16:9 “widescreen” format, usually associated with HDTV formats.
16:10	Sets the aspect ratio to 16:10 “widescreen” format, usually associated with computer displays and smart devices.
4:3	Sets the aspect ratio to 4:3 “pan-and-scan” format, usually associated with SDTV.

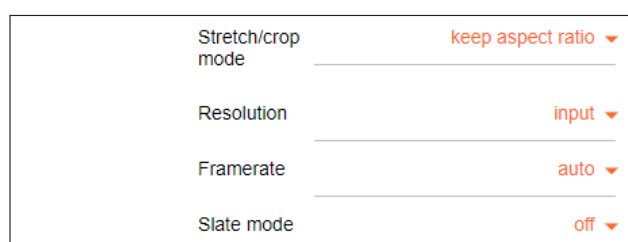

Resolution

Click this drop-down list to select the desired output resolution. This is a scaler feature which can either upscale or downscale the output on the decoder. If **Input** is selected, then no scaling will be applied to the output. Select **Auto** to use the EDID of the sink device to determine the output resolution.

Resolutions	
Input	1440 x 1050
Auto	1440 x 900
4096 x 2160	1280 x 1024
3840 x 2160	1280 x 800
1920 x 1200	1280 x 768
1920 x 1080	1280 x 720
1680 x 1050	1024 x 768
1600 x 900	



NOTE: When working with VESA resolutions 1360x768p60 and 1366x768p60, the **Resolution** drop-down list must be set to **Auto**.

Framerate

Sets the output frame rate. Available options are `auto`, 60 Hz, 50 Hz, and 30 Hz, except for the OMNI-122 where the options are `auto` and 30 Hz.

Slate Mode

Click this drop-down list to select the slate mode. Refer to [Slate / Logo Insertion \(page 31\)](#) for more information.

Mode	Description
Off	Disables the image from being displayed.
Manual	Stretches the image to fill the screen. In some cases this can distort (“stretch”) the image.
Auto	The image will only be displayed when the source signal is lost. For example, this mode is useful in conference room applications for displaying system instructions when no sources are connected.

Video Wall

Click this toggle switch to enable or disable the video wall option. Refer to [Creating Video Walls \(page 73\)](#) for more information on using video walls.

Fast Switching

Click this toggle switch to enable or disable fast-switching. When enabled, the fast-switching timeout interval can also be adjusted. Refer to [Fast Switching \(page 37\)](#) for more information.

TO PRIMARY

Click this button to assign as the Primary IP Input. Both Video and Audio support this feature.

TO BACKUP

Click this button to force the audio stream to fall over to the Backup IP Input (if redundancy is configured). Both Video and Audio support this feature.

Input

Click this drop-down list to select the primary audio IP input. Select the **Not Used** option to leave the audio input unassigned.

Backup Mode

Click this drop-down list to select the backup mode. Both Video and Audio provide the Backup Mode feature.

Mode	Description
Off	Backup source is disabled; join request not sent.
Join Active	The decoder sends a join request only when the decoder decides to switch between audio sources. Switch time will not exceed 5 seconds.
Join Always	The decoder always joins to the backup audio source. Switch time will not exceed 0.5 seconds.

Backup Input

Select the secondary video backup IP input from this drop-down list. If the primary IP input is down, then the decoder will automatically switch to this input. Refer to the **Backup Mode** option, above, for setting the conditions for switching inputs. Both Video and Audio provide the Backup Input feature.

Configuration Grace Period

To prevent the decoder from automatically making the redundancy switch, when redundancy is enabled, a grace period can be entered. By default, the grace period is set to zero seconds. If set to zero seconds, automatic failover will occur, if the stream is interrupted for any reason. Refer to [Configuring Redundant Streams \(page 111\)](#) for more information.

Active Input

Displays the active audio input.

Downmixing

Click this drop-down list to select how LPCM audio will be down-mixed. Note that lossless audio formats cannot be down-mixed.

Video Wall Enable

Fast Switching Enable

Audio

Input ip_input3 ▼

Backup mode Off ▼

Backup input ip_input9 ▼

Configuration grace period (s) 0

Active input ip_input3

Downmixing none ▼

Type	Description
None	Audio is not down-mixed.
Stereo	Audio is down-mixed to two-channel stereo.
Auto	Display is always on, source audio/video signal switches on/off

Enable AES67

Click this toggle switch to enable or disable AES67. When enabled, the toggle switch will be green. Refer to [AES67 Audio \(page 70\)](#) for more information.

Status

Displays the active audio input. If no input is active or detected, then this field will display “No active audio”.

Mute

Click this toggle switch to enable or disable the audio output. If enabled, the toggle switch will be green.

Volume

Click the speaker icon on the left to decrease volume. Click the speaker icon on the right to increase volume. Range: 0 to 15.

Analog Power

This indicator will be green when the decoder is powered by the optional external 48 V DC power supply.

Analog Power

If analog output is connected to the decoder, then click this toggle switch to use the analog audio output. When enabled, this toggle switch will be green.

TO PRIMARY

Click this button to assign as the Primary IP Input. Both Video and Audio support this feature.

TO BACKUP

Click this button to force the audio stream to fall over to the Backup IP Input (if redundancy is configured). Both Video and Audio support this feature.

AUX (CEC)

Click this drop-down list to select the desired IP input for CEC control. Available options are ip_input1 - ip_input12, none, and generator.

Timeout (s)

Enter the time interval, in seconds, before the next command can be accepted by the display.

Type

Click this drop-down list to select the display mode.

Type	Description
DispSW AVon	Display switches on/off, source audio/video signal always on.
DispSW AVSW	Display switches on/off, source audio/video signal switches on/off.
AV SW	Display is always on, source audio/video signal switches on/off
Always on	Display is always on, source audio/video signal always on.

SAVE

Click this button to commit all changes within the **Output** window group.

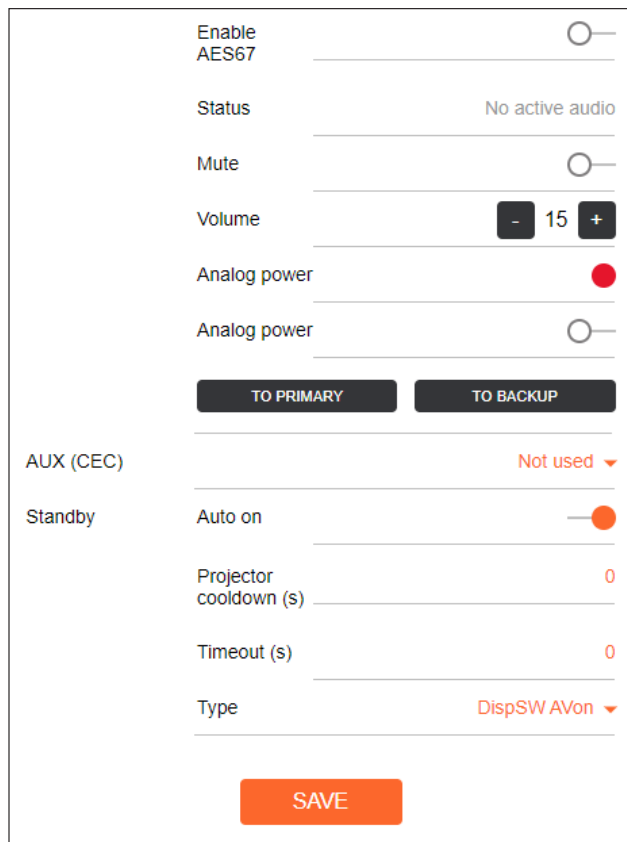

Auto On

Click this toggle switch to enable or disable power-on. When enabled this toggle switch will be green and the power-on command will be sent to the display when an A/V signal is detected.

Projector Cooldown (s)

Enter the time interval, in seconds, before the projector can be powered-off. This time interval prevents the decoder from sending additional commands until the projector has had time to complete its cool-down process.

Logo page

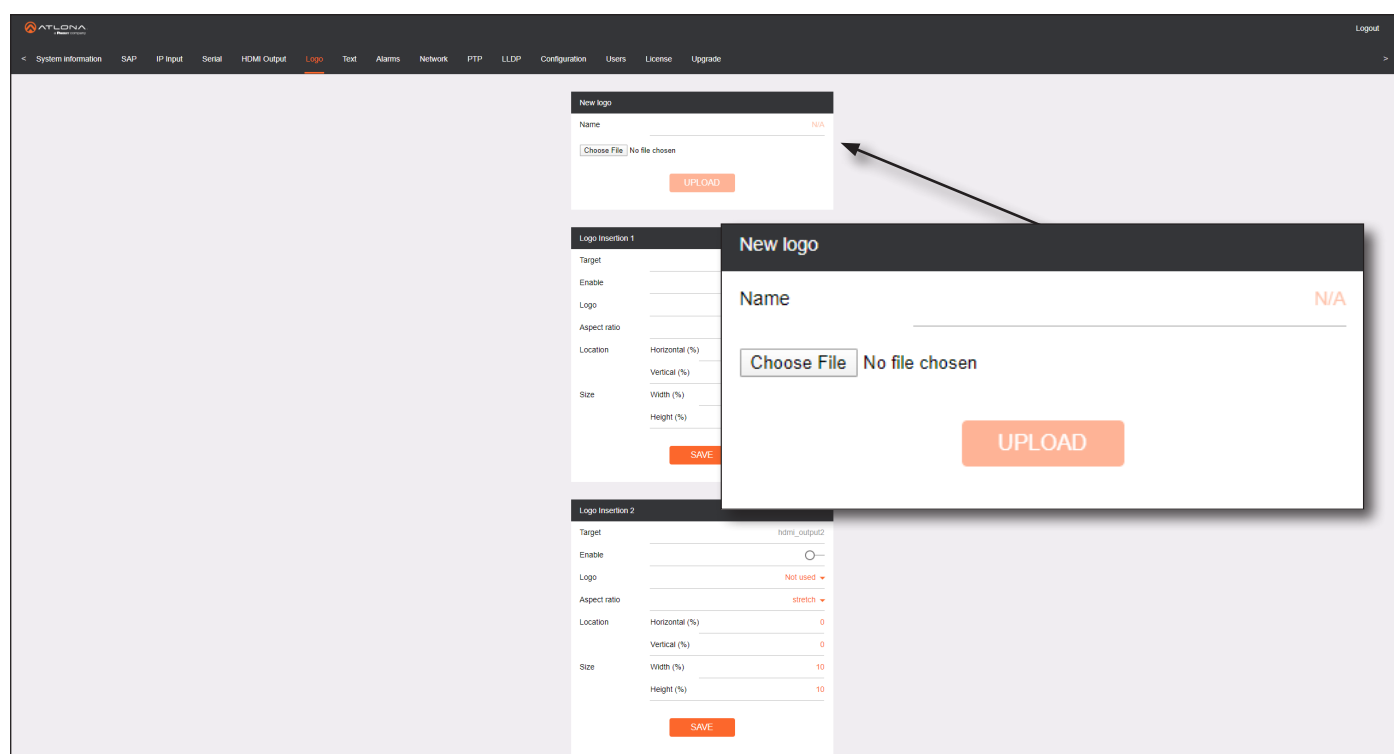

New logo window group

Name

Enter a name for the logo in this field.

Choose File

Click this button to select the logo file to be uploaded. Files must be in .png format and must not exceed 5 MB (5120000 bytes) in size. When an image file is uploaded, it will appear in the **Logo** drop-down list.

UPLOAD

Click this button to upload the logo file to the decoder.

Logo Insertion window groups

The following fields apply to both **Logo Insertion** window groups. The single-channel encoder will only have one **Logo Insertion** window group.

Target

Displays the name of the encoder. This field cannot be changed.

Enable

Click the toggle switch to enable or disable the logo. If the toggle switch is orange, then the logo will be enabled.

Logo

Click this drop-down list to select the desired logo. To disable the use of a logo, set to **Not Used**.

Aspect Ratio

Click this drop-down list to select the type of aspect ratio to be applied to the logo.

Logo Insertion 1	
Target	hdmi_output1
Enable	<input type="checkbox"/>
Logo	Not used ▾
Aspect ratio	stretch ▾

Horizontal (%)

Enter the horizontal position of the logo on the screen. This value is based on the total horizontal resolution of the screen.

Vertical (%)

Enter the vertical position of the logo on the screen. This value is based on the total vertical resolution of the screen.

Width (%)

Enter the width of the logo. This value is based on the total horizontal resolution of the screen.

Height (%)

Enter the height of the logo. This value is based on the total vertical resolution of the screen.

SAVE

Click this button to commit all changes within the **Logo Insertion** window group.

Location	Horizontal (%)	0
	Vertical (%)	0
Size	Width (%)	10
	Height (%)	10

SAVE

Text page

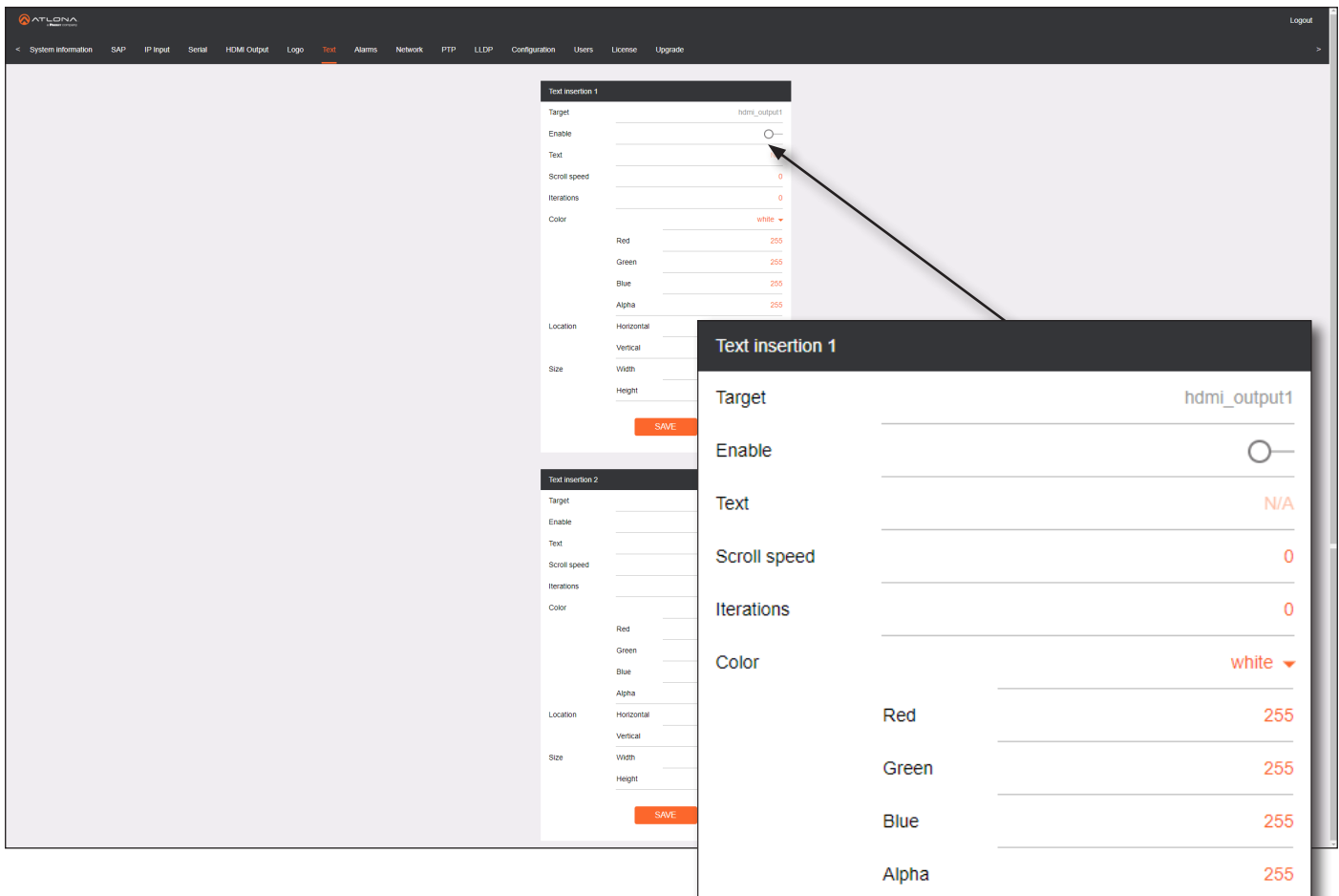

Text insertion window groups

The following fields apply to both **Text insertion** window groups. The single-channel encoder will only have one **Text insertion** window group.

Target

Displays the name of the output where the text will appear. This field cannot be changed.

Enable

Click this toggle switch to enable or disable the text. When the toggle switch is orange, the text will be enabled.

Text

Enter the desired text in this field.

Scroll Speed

Enter the scrolling speed in this field. Values from -255 to 255 are valid. Negative numbers will scroll the text from left to right. Positive numbers will scroll text from right to left.

Iterations

Enter the number of iterations in the **Iteration** field. Set this field to 0 (zero) to set the number of iterations to infinity.

Color

Click this drop-down list to select a solid color preset: **red, green, black, white, yellow, or blue.**

Red, Green, Blue, Alpha

Click these fields to fine tune the color of the text. Adjust the **Alpha** field to control the transparency of the text. An alpha value of 255 is opaque and a value of 0 is transparent. Numbers from 0 to 255 are valid for all fields.

Horizontal

Enter the horizontal position of the text in this field.

Vertical

Enter the vertical position of the text in this field.

Width

Enter the width of the text in this field. This value is based on the horizontal resolution of the screen.

Height

Enter the height of the text in this field. This value is based on the vertical resolution of the screen.

SAVE

Click this button to commit all changes within the **Text insertion** window group.

Location	Horizontal	<input type="text" value="0"/>
	Vertical	<input type="text" value="0"/>
Size	Width	<input type="text" value="10"/>
	Height	<input type="text" value="10"/>

Network page

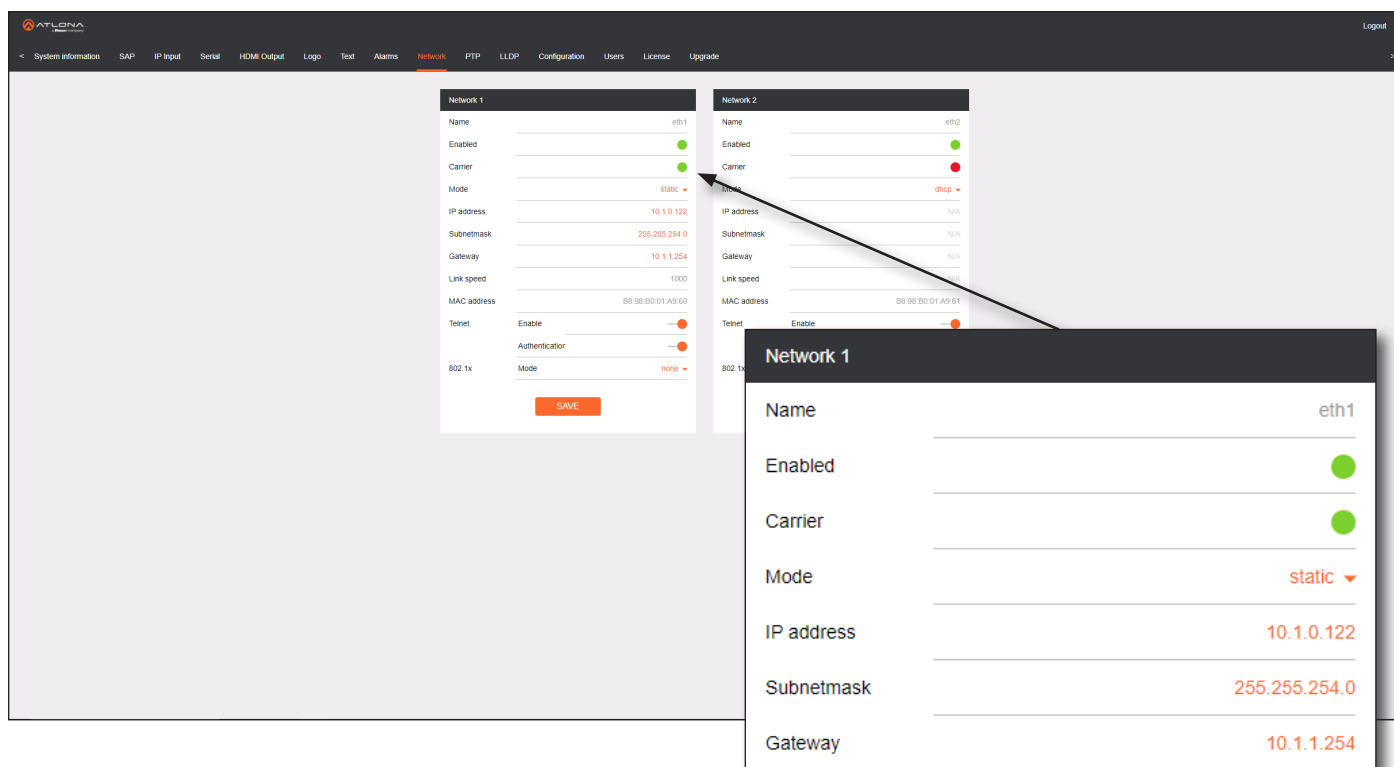

Network window groups

The following fields apply to both **Network** window groups. The single-channel decoder will only have one **Network** window group.

Name

Displays the name of the Ethernet interface. This field cannot be changed.

Enabled

This indicator displays whether or not the video stream for this channel is active. If the indicator is green, then the video stream is active.

Carrier

If this indicator is green, then an active link exists. Otherwise, if no link exists, this indicator will be red.

Mode

Click this drop-down list to select the desired IP mode. Select DHCP to let the DHCP server (if present) assign the encoder the IP settings; **Subnet** and **Gateway** fields will automatically be populated. When **Static** mode is selected, the information for the **IP Address**, **Subnet**, and **Gateway** fields must be entered.

IP Address

Displays the IP address used by the channel. This field can only be changed if **Static** mode is selected.

Subnetmask

Displays the subnet mask for the channel. This field can only be changed if **Static** mode is selected.

Gateway

Displays the gateway (router) address for the channel. This field can only be changed if **Static** mode is selected.

Link speed

Displays the Ethernet interface link speed in Mbps. This field cannot be modified.

MAC address

Displays the MAC address of the Ethernet interface.

Telnet Enable

Click this toggle switch to enable or disable Telnet. If disabled, then Telnet sessions to the decoder cannot be established.

Telnet Authenticator

Click this toggle switch to enable or disable Telnet authentication. If enabled, then the toggle switch will be orange. Once enabled, connecting to the decoder using Telnet will require login credentials. The default credentials are:

Username: admin
 Password: Atlona

WebUI Enable HTTP

Click this toggle switch to enable or disable HTTP. If disabled, traffic on port 80 is forbidden.

WebUI Enable HTTPS

Click this toggle switch to enable or disable HTTPS. If disabled, traffic on port 443 is forbidden.

802.1x Mode

Click this drop-down list to select the desired authentication mode.

SAVE

Click this button to commit all changes within the **Network** window group.

Gateway		10.1.1.254
Link speed		1000
MAC address		B8:98:B0:01:A9:60
Telnet	Enable	<input checked="" type="checkbox"/>
	Authentication	<input checked="" type="checkbox"/>
WebUI	Enable HTTP	<input checked="" type="checkbox"/>
	Enable HTTPS	<input checked="" type="checkbox"/>
802.1x	Mode	none ▼

SAVE

PTP page

The **PTP** page provides options for adjust Precision Time Protocol (PTP) for AES67 audio streams. PTP is used by AES67 to keep all audio streams synchronized.

For a system utilizing PTP, all devices undergo an automatic self-election process to choose the interface to be used as the PTP grandmaster (GM) clock, based on the accuracy of the device's clock and the device's configured priority. A lower priority number means the unit is more likely to get selected as GM.



IMPORTANT: If a new device is added to the network and the GM changes, a brief outage will be experienced while all connected devices synchronize with the new clock. Because of this, Atlona recommends that one unit gets manually defined as the GM and have both **Priority 1** and **Priority 2** fields be set to 1.

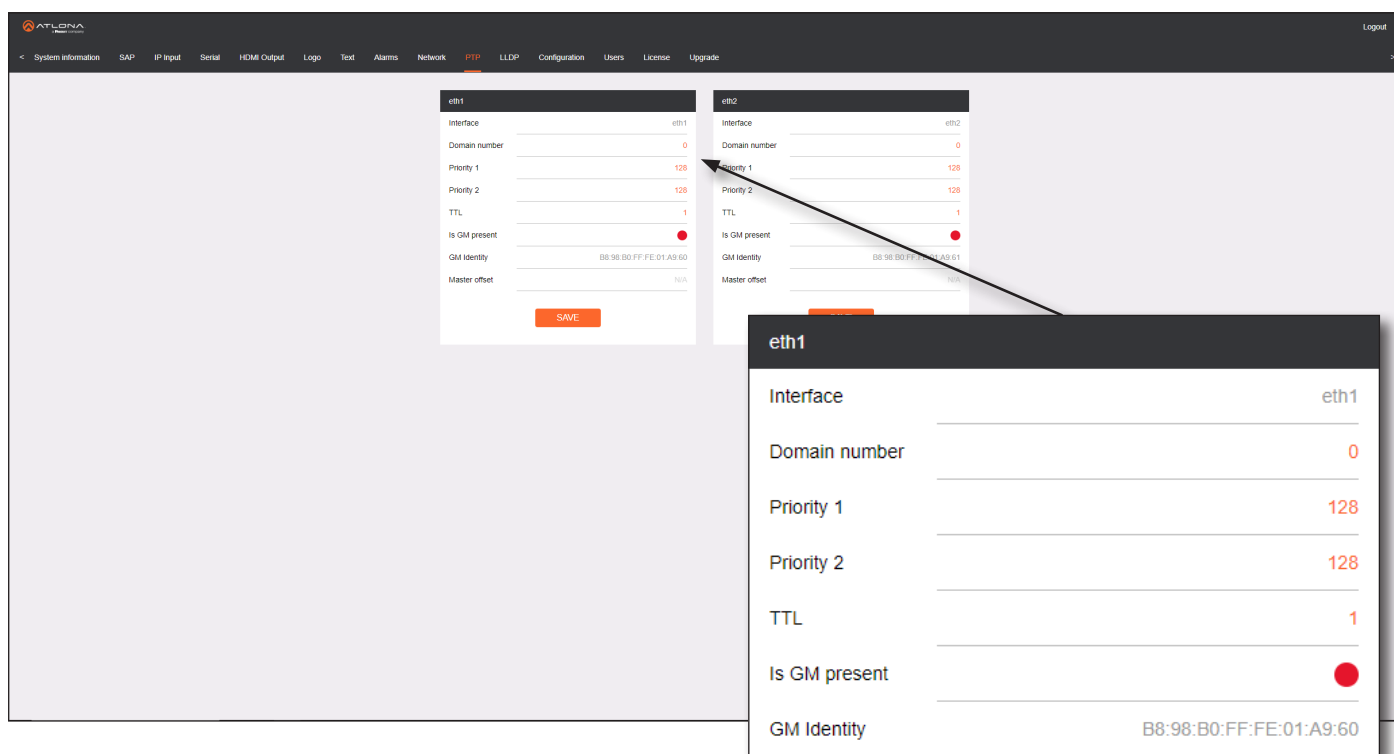

eth window groups

The following fields apply to both **eth** window groups. The single-channel encoder will only have one **eth** window group.

Interface

Displays the Ethernet interface associated with the PTP settings.

Domain Number

Enter the domain number in this field. Valid entries are 0 through 127.

Priority 1

Enter the priority number in this field.

Priority 2

Enter the priority number in this field.

TTL

Displays the TTL value. PTP uses a default IPv4 TTL value of 1 for multicast. This value may be changed, if necessary, in order for the replies to reach the PTP monitor.

Is GM Present

This indicator displays the existence of a grandmaster clock for the specified PTP domain number. If the indicator is green, then the grandmaster clock exists on this interface.

GM Identity

The grandmaster clock identity. If this field is blank, then it means that this interface is the grandmaster clock.

Master Offset

Displays the grandmaster clock offset.

SAVE

Click this button to commit all changes within the **eth1** / **eth2** window groups.

eth1	
Interface	eth1
Domain number	0
Priority 1	128
Priority 2	128
TTL	1
Is GM	●
GM Identity	B8:98:B0:FF:FE:01:A9:60
Master offset	0

SAVE

LLDP page

The Link Layer Discovery Protocol (LLDP) page returns information about the switch that the encoder is connected to. If both interfaces from a dual-channel encoder are connected to the switch, then two **eth** window groups will be displayed.



NOTE: LLDP must be enabled on the switch that the encoders are connected to, in order for the switch information to be displayed.

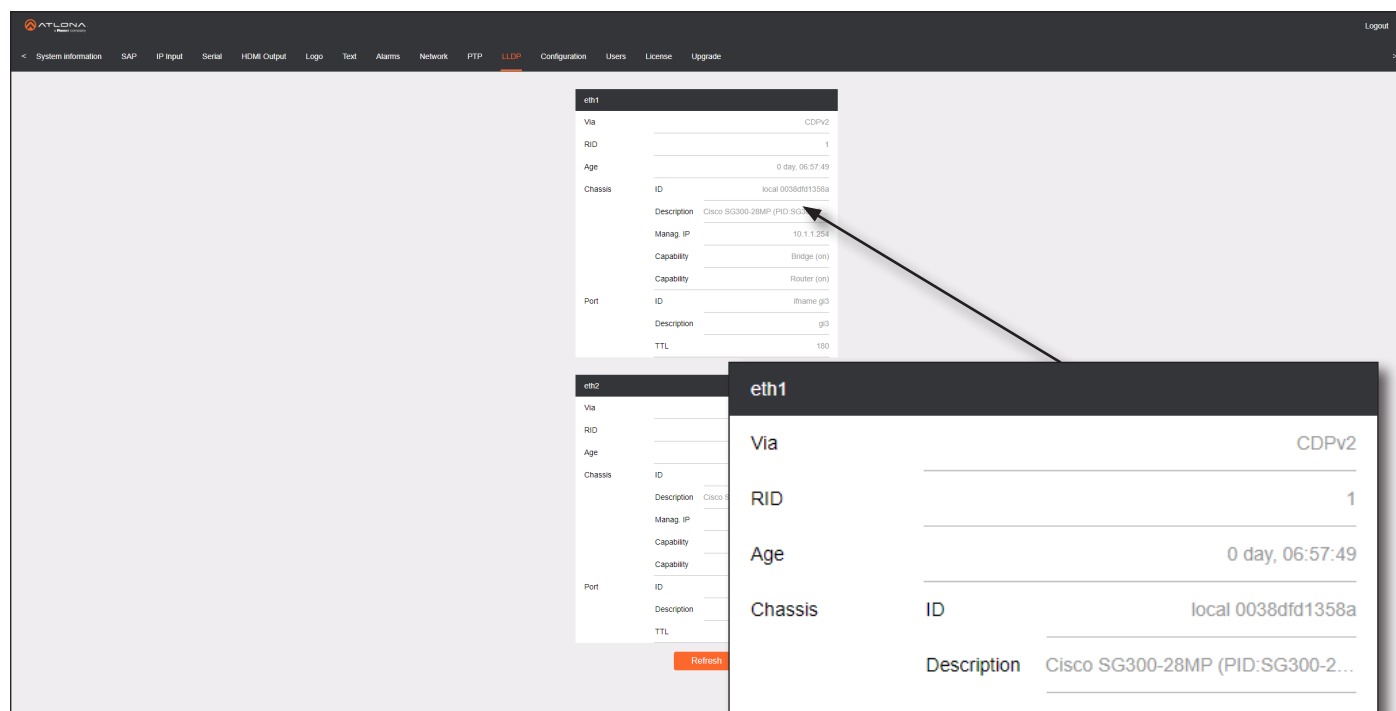

Via
The discovery protocol being used.

RID
The router ID.

Age
Up-time of the interface.

Chassis ID
The MAC address of the interface.

Chassis Capability
Indicates the device function, such as bridge (switch), router, etc.

Port ID
The port ID.

Port Description
The type of port, such as gigabit Ethernet, fast Ethernet, etc.

TTL
The Time-To-Live value.

Refresh
Click this button to refresh the page after a port change.

Configuration page

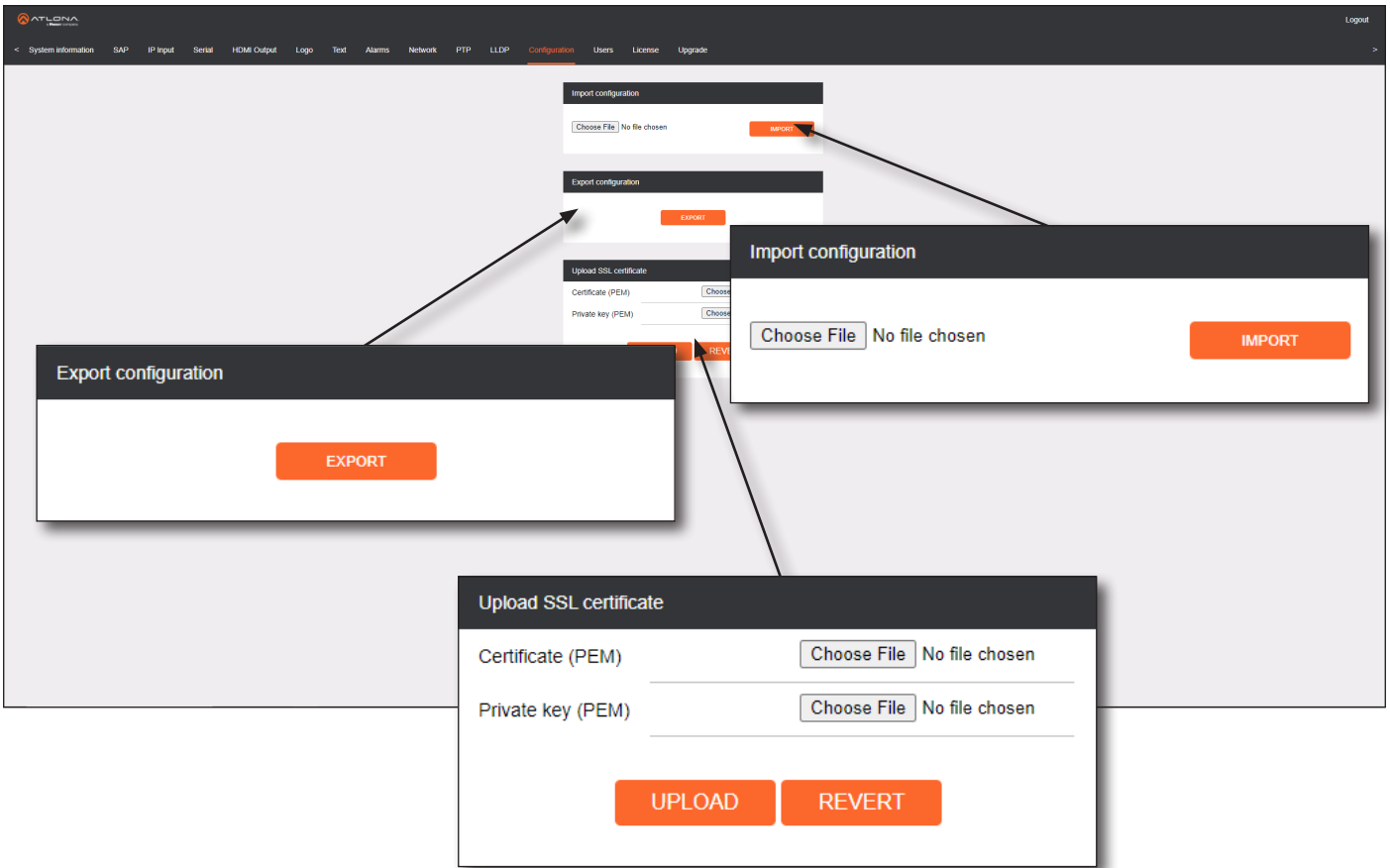

Import configuration

Choose File

Click this button to select the desired configuration file to be uploaded.

IMPORT

Click this button to upload the selected configuration file to the encoder.

Export configuration

EXPORT

Click this button to export the current encoder system configuration to a .json file.

Upload SSL certificate

Choose File

Click these buttons to select the desired certificate or private key.

UPLOAD

Click this button to upload the certificate/private key to the encoder.

REVERT

Click this button to restore the previous configuration.

Users page

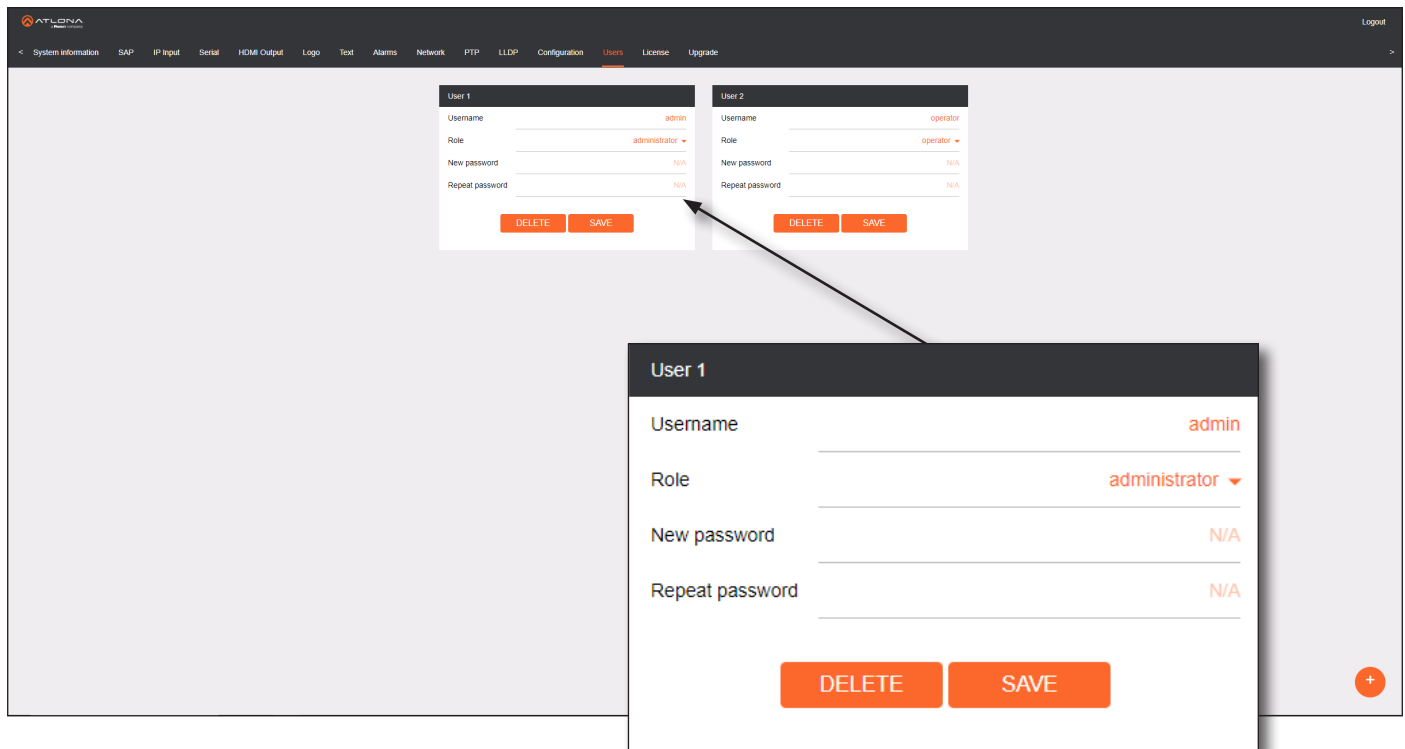

User window groups

The following fields apply to all **User** window groups. Encoders have two usernames, by default: **admin** and **operator**.

Username

Enter the desired username in this field.

Role

Click this drop-down list to select the desired role of the user.

New password

Enter the desired password for the username in this field.

Repeat password

Confirm the new password by entering it in this field.

DELETE

Click this button to delete the user in the current window group. Note that there must be at least one admin role at all times. Therefore, if one **admin** role and one **operator** role exist, then the **admin** user cannot be deleted.

SAVE

Click this button to commit all changes within the current user window group.



New user

Click this button to create a new user. Provide the role and password, as described in the fields above.

License page

This page displays all installed licenses and allows additional licenses to be installed.

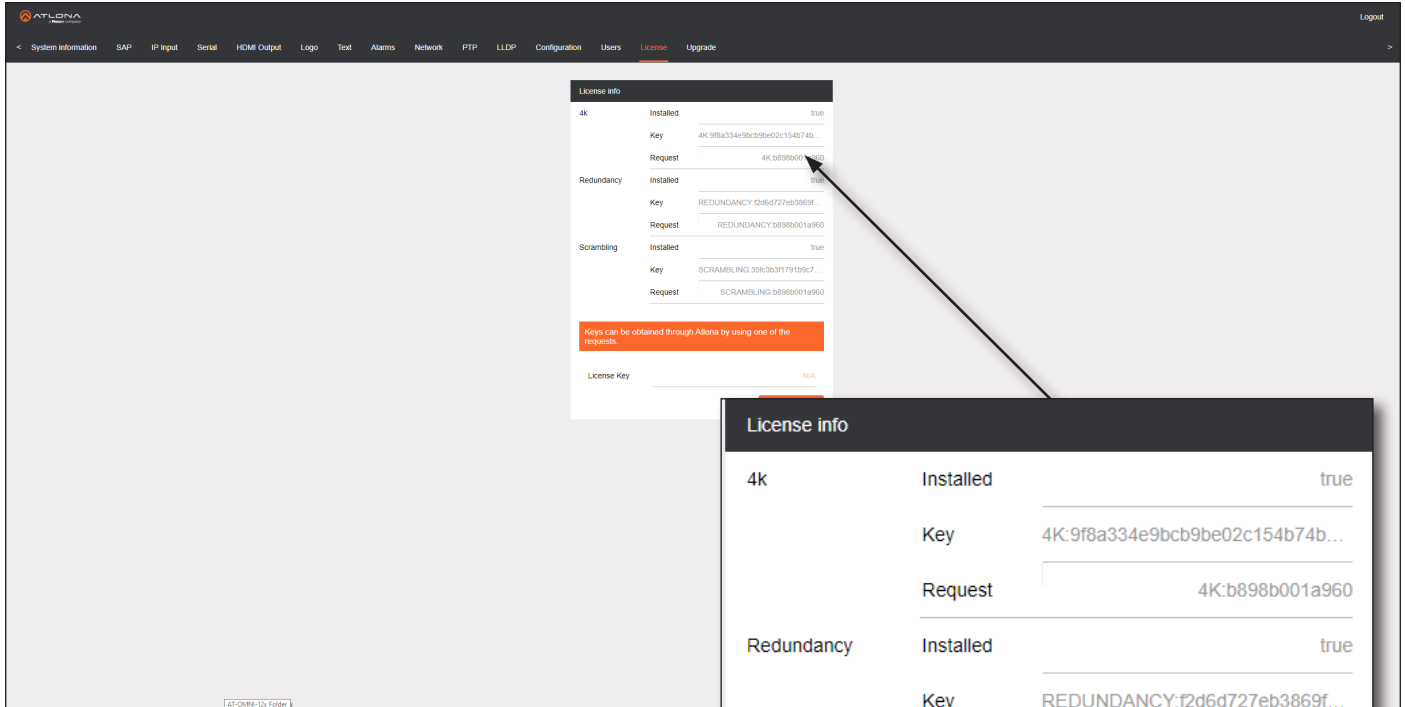

License Key

Enter the license key in this field.

INSTALL LICENSE

Click this button to validate and install the license.

License info

4k	Installed	true
	Key	4K:9f8a334e9cb9be02c154b74b...
	Request	4K:b898b001a960
Redundancy	Installed	true
	Key	REDUNDANCY:f2d6d727eb3869f...
	Request	REDUNDANCY:b898b001a960
Scrambling	Installed	true
	Key	SCRAMBLING:35fc3b3f1791b9c7...
	Request	SCRAMBLING:b898b001a960

Keys can be obtained through Atlona by using one of the requests.

License Key N/A

INSTALL LICENSE

Upgrade page

This page is used to update the firmware on the encoder.

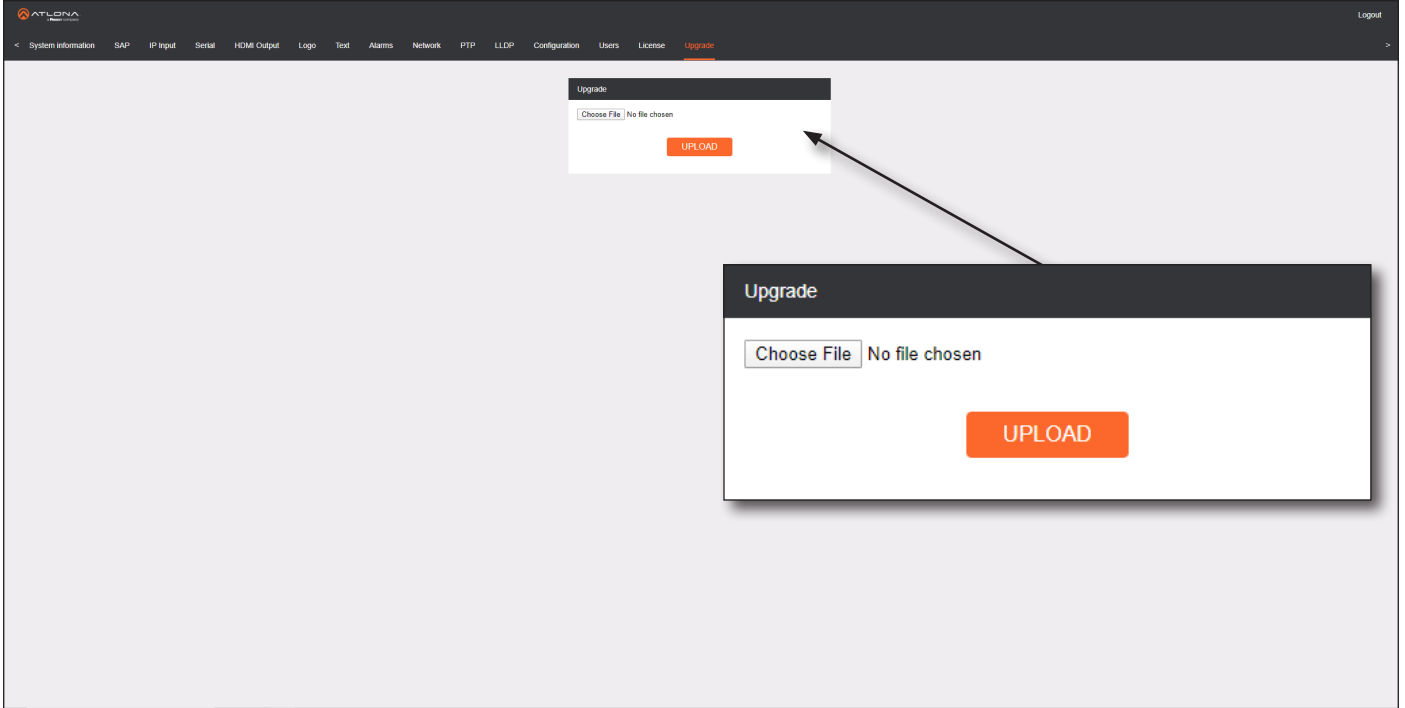

Choose File

Click this button to select the firmware file to be uploaded.

UPLOAD

Click this button to upload the selected firmware file.

Appendix

Updating the Firmware using Velocity™/AMS

IMPORTANT:



- If updating from version 1.0.x, OmniStream units must first be updated to version 1.1. Note that this does *not* apply to OmniStream R-Type units. If running version 1.0.x, contact an Atlona Technical Support Engineer before updating the firmware.
- When updating the firmware, make sure that the unit does not lose power. The firmware update process should take approximately 1 to 2 minutes.
- For full functionality of OMNI 1.2.1 (or later), Velocity must be running at least 1.4.5 and AMS must be on firmware version 2.0.12 and above.

1. Click **DEVICE INFO** in the menu bar.
2. Click the **UPDATE FIRMWARE** button to display the **Firmware Update** dialog.

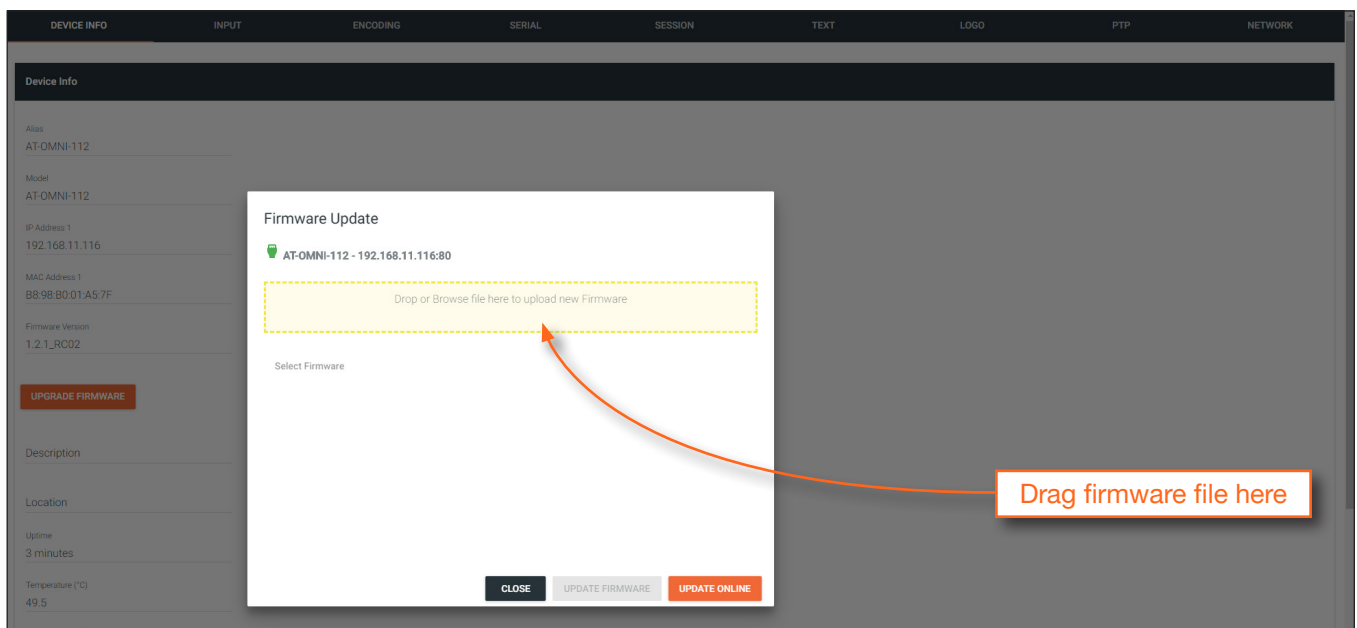

- Click and drag the firmware file to the yellow box, to upload the firmware to the device. OmniStream firmware files use the .vpup2 file extension. Once the firmware file has been uploaded, it will appear under the **Select Firmware** section of the dialog box.
- Click the **UPDATE FIRMWARE** button to begin the update process.

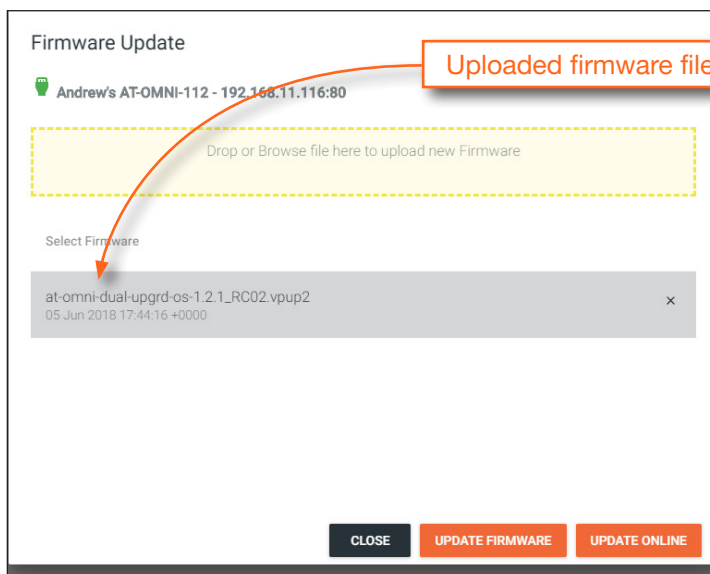

Firmware file	OmniStream SKU
at-omni-single-upgrd-os-[version].vpup2	AT-OMNI-111, AT-OMNI-121, AT-OMNI-111-WP
at-omni-dual-upgrd-os-[version].vpup2	AT-OMNI-112, AT-OMNI-122
at-omni-residential-upgrd-os-[version].vpup2	AT-OMNI-512, AT-OMNI-521

- After the **UPDATE FIRMWARE** button is clicked, the Upgrade Firmware Started message box will be displayed.

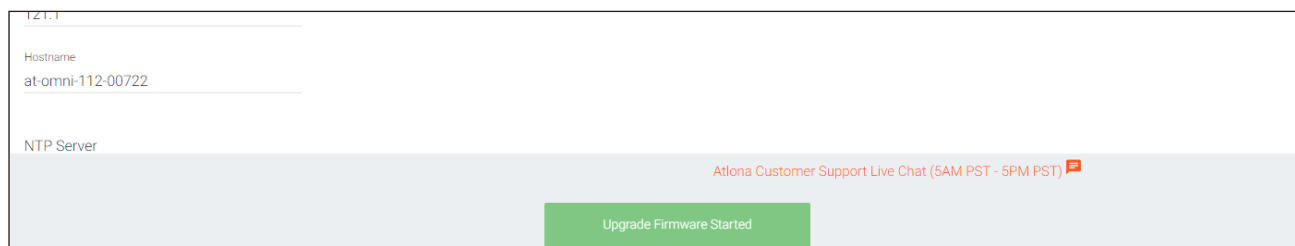

- Click the orange up-arrow icon, in the upper-right corner of the screen, as shown below. If this icon is orange, it indicates that a firmware update is in progress.

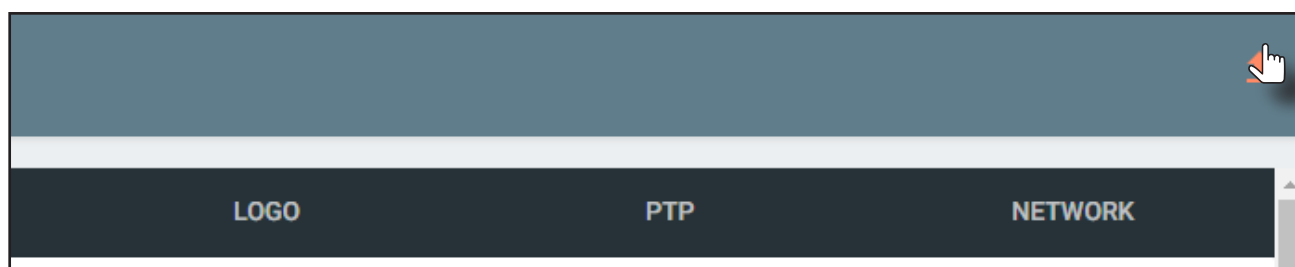

The progress bar for the update process will be displayed. The update process should take a few seconds.

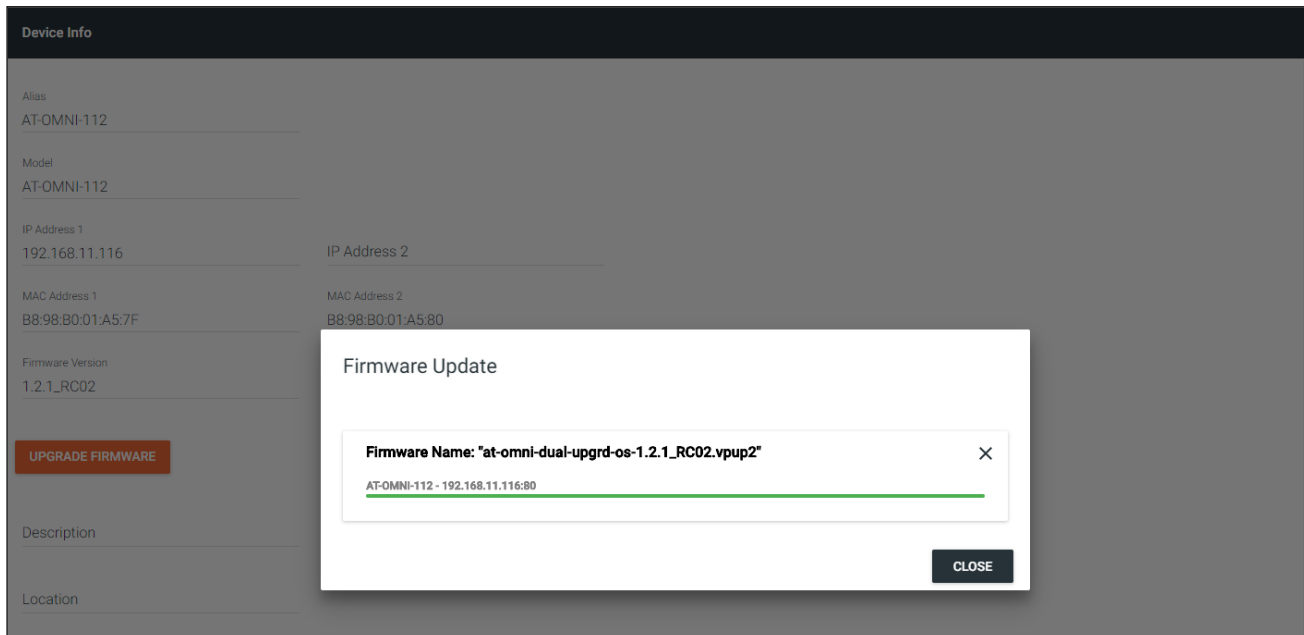

7. Click the "X" to close out the progress bar window, then click the **CLOSE** button to dismiss the **Firmware Update** message box.
8. The firmware update process is complete.
9. Clear the web browser cache and refresh the web page. The new firmware version will appear in the **Firmware Version** field, in the **DEVICE INFO** page.

Updating the Firmware using the Web Server

Follow the procedure below to update OmniStream units using the built-in web server.

1. Launch the desired web browser and enter the IP address of the encoder/decoder in the address bar.
2. Enter the username and password. Note that the password field will always be masked. The default credentials are:

Username: admin
 Password: Atlona

3. The **System Information** page will be displayed.
4. Click **Upgrade** in the menu bar to display the **Upgrade** page.
5. Click the **Choose File** button.

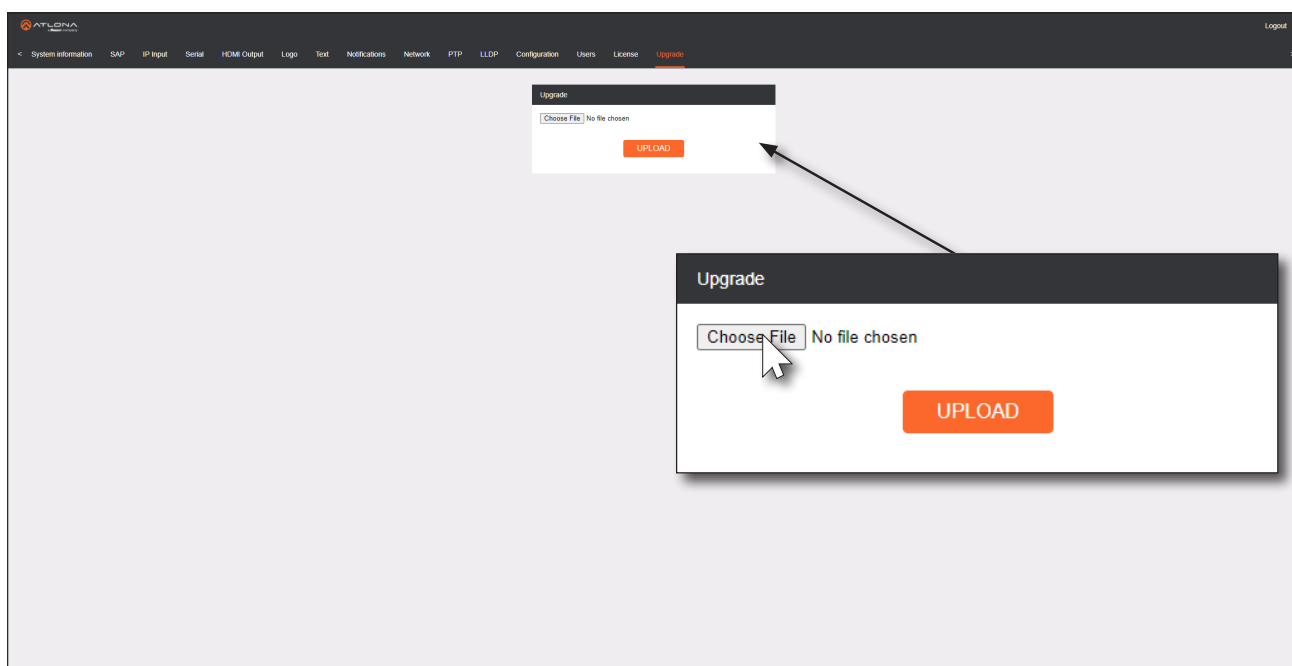

6. In the **Open** dialog box, select the correct firmware file. Refer to the table below.

Firmware file	OmniStream SKU
at-omni-single-upgrd-os-[version].vpup2	AT-OMNI-111, AT-OMNI-121, AT-OMNI-111-WP
at-omni-dual-upgrd-os-[version].vpup2	AT-OMNI-112, AT-OMNI-122
at-omni-residential-upgrd-os-[version].vpup2	AT-OMNI-512, AT-OMNI-521

7. Click the **UPLOAD** button.
8. A progress bar will be displayed, indicating the current upgrade status of the unit. When firmware update process has completed, the **Upgrade** page will be displayed.
9. The upgrade process is complete.

FEC Details

Matrix Size, Overhead, and Latency

- FEC can only work if a single packet from each row/column is missing. Multiple packets missing from each row/column will cause FEC to fail.
- Due to the above, a smaller matrix is more robust, as there is a better chance of errors not occurring in the same row/column.
- FEC has a bitrate overhead that is inversely proportional to the matrix size: the bigger the matrix, the less bitrate overhead is generated.
- FEC has a latency overhead that is directly proportional to the matrix size: the bigger the matrix, the more latency is introduced.
 - » As of v1.0.0, OmniStream does not explicitly synchronize audio and video. Therefore, FEC configuration can have a noticeable impact on lip sync. The tables below should be used to keep the audio/video lip sync as tight as possible.
- FEC latency overhead is also inversely proportional to bitrate: the higher the bitrate, the less FEC latency is introduced.
 - » For applications where lip sync is very critical, using a higher audio sampling rate, and thus a higher audio bitrate, can result in more accurate lip sync.

FEC and Video Bitrate

- The bitrate configured on the video encoder includes FEC overhead and will automatically adjust itself depending on the bitrate needed for FEC.
- FEC overhead can be calculated using the following formulas:

$$\text{Video rate} = \frac{\text{Configured bit rate}}{1 + \left(\frac{\text{Rows} + \text{Columns}}{\text{Rows} \times \text{Columns}} \right)} \qquad \text{FEC rate} = \text{Configured bit rate} - \text{Video rate}$$

- The following table provides a few examples of how this works.

FEC / matrix usage	Configured bit rate	Used for video	Used for FEC
FEC disabled	900 Mbps	900 Mbps	0 Mbps
FEC enabled, 4x4	900 Mbps	600 Mbps	300 Mbps
FEC enabled, 10x10	900 Mbps	750 Mbps	150 Mbps
FEC enabled, 20x20	900 Mbps	818 Mbps	82 Mbps
FEC enabled, 4x4	450 Mbps	300 Mbps	150 Mbps
FEC enabled, 10x10	450 Mbps	375 Mbps	75 Mbps
FEC enabled, 20x20	450 Mbps	409 Mbps	41 Mbps

FEC, Latency, and Lip Sync

- In order for FEC to work, the matrix must be filled in order to calculate the FEC packets. This introduces some additional latency. Due to high bitrates, this is not noticeable for video, but can be very significant for audio. Therefore, Atlona recommends either leaving FEC disabled for audio or using a very small matrix.
- Latency calculations are complex. The tables below provide some common working benchmarks. In order to minimize lip sync issues, try to match the additional latencies for video and audio as closely as possible.
 - » Video - additional video latency for enabling FEC using various matrix sizes.

Configured bit rate	4x4	10x10	20x20
900 Mbps	0.64 ms	3.20 ms	11.74 ms
450 Mbps	1.28 ms	6.40 ms	23.47 ms

- » Audio - additional audio latency for enabling FEC using various matrix sizes.

Format	1x4	2x4	4x4	10x10
2 channel PCM, 44.1 kHz	34.01 ms	68.03 ms	136.10 ms	850.30 ms
2 channel PCM, 48 kHz	31.25 ms	62.50 ms	125.00 ms	781.30 ms
2 channel PCM, 96 kHz	15.63 ms	31.25 ms	62.50 ms	390.60 ms
2 channel PCM, 192 kHz	7.81 ms	15.63 ms	31.25 ms	195.30 ms

- It is recommended to keep lip sync within ± 1 frame of video to prevent any noticeable syncing issues.
- Examples of good choices to minimize lip sync issues are:
 - » Video configured for 450 Mbps, FEC 10x10; Audio is 2 channel PCM, 192 kHz, FEC 1x4: 6.40 ms – 7.81 ms = -1.41 ms
 - » Video configured for 900 Mbps, FEC 10x10; Audio is 2 channel PCM, 48 kHz, FEC disabled: 6.40 ms – 0 ms = 6.40 ms

Mounting Instructions

OmniStream decoders includes two mounting brackets and four mounting screws, which can be used to attach the unit to any flat surface.

- Using a small Phillips screwdriver, remove the two screws from the left side of the enclosure.

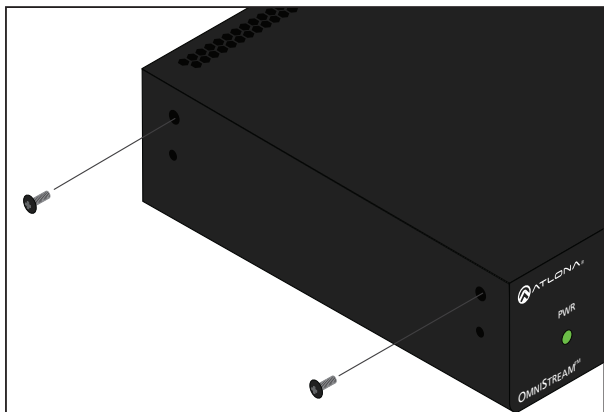

- Position one of the rack ears, as shown below, aligning the holes on the side of the enclosure with one set of holes on the rack ear.
- Use the enclosure screws to secure the rack ear to the enclosure.

Included screws

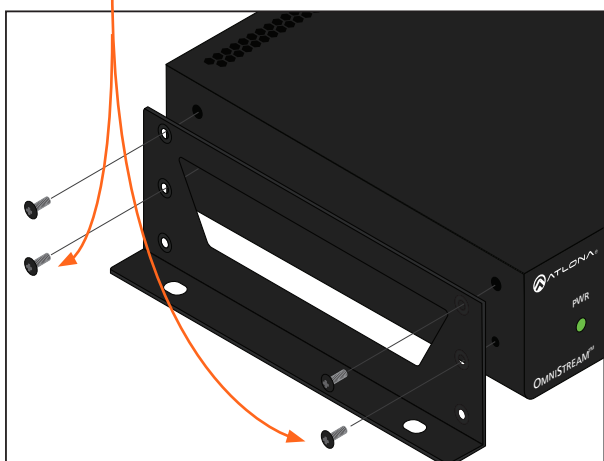

- To provide added stability to the rack ear, use two of the included screws and attach them to the two holes, directly below the enclosure screws, as shown above.
- Repeat steps 1 through 4 to attach the second rack ear to the opposite side of the unit.

- Mount the unit using the oval-shaped holes, on each rack ear. If using a drywall surface, a #6 drywall screw is recommended.

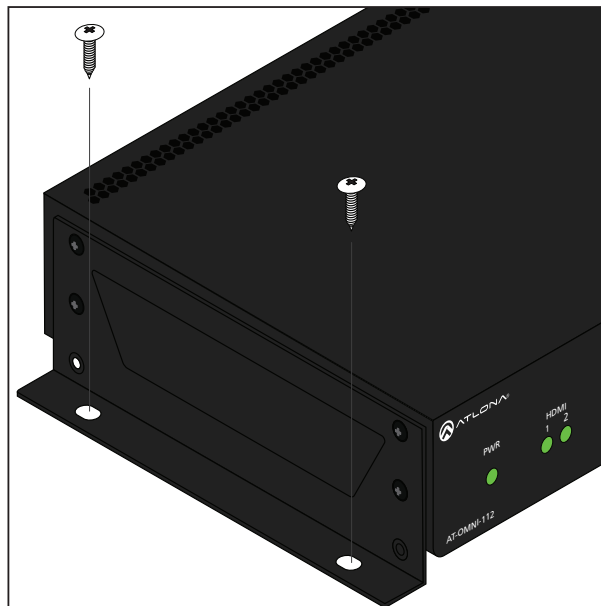

NOTE: Rack ears can also be inverted to mount the unit under a table or other flat surface.

Rack Tray for OmniStream

OmniStream decoders can also be mounted in the OmniStream rack tray (AT-OMNI-1XX-RACK-1RU). The rack tray is sold separately and provides easy mounting and organization of up to two OmniStream encoders/decoders in a convenient 1U rack tray. The OmniStream rack tray can be purchased directly from Atlona.

1. Position the OmniStream products, as shown in the illustration below.
2. Using the included screws, secure each unit to the rack with a Philips screwdriver.



NOTE: OmniStream units can be mounted forward-facing or back-facing, depending upon your requirements.

3. Install the entire assembly into an empty 1U slot in the rack.

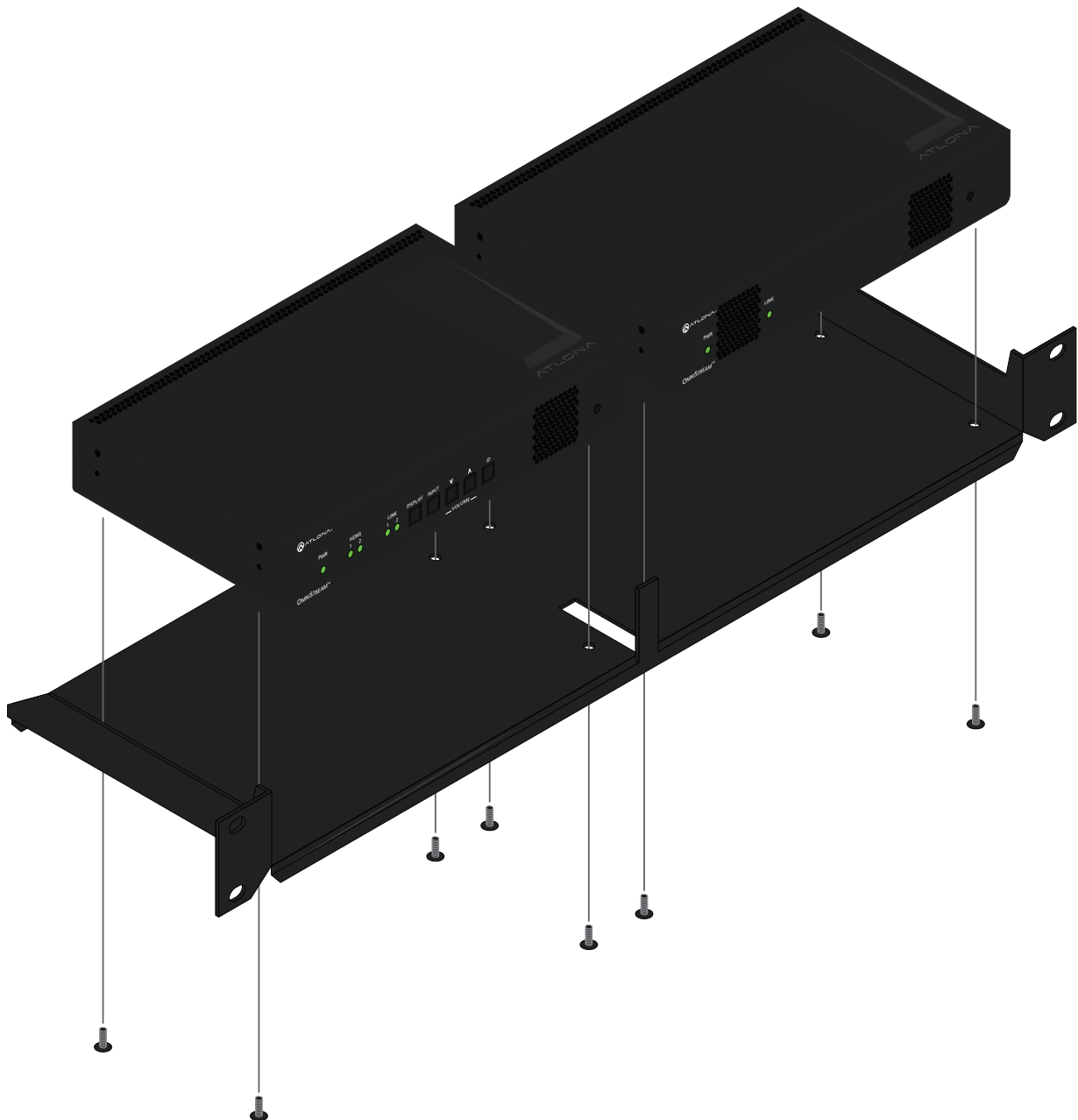

Audio			
Pass-through	LPCM 2.0 LPCM 5.1 LPCM 7.1	Dolby® Digital Dolby Digital Plus Dolby TrueHD	Dolby Atmos® DTS® DTS-HD Master Audio™
Down-mixing	Multichannel LPCM to two-channel LPCM		
Sample Rate	32 kHz, 44.1 kHz, 48 kHz, 88.2 kHz, 96 kHz, 176.4 kHz, 192 kHz		
Bit Depth	Up to 24-bit		
Analog audio ⁽⁴⁾	Balanced output: +4 dBu nominal gain, +20 dB headroom Frequency response: 20 Hz to 20 kHz, ± 0.5 dB Output impedance: 150 Ω Stereo channel separation: > 90 dB THD+N: < 0.03% at 20 Hz to 20 kHz SNR: > 90 dB at 1 kHz, zero clipping @ 0 dBFS, unweighted		

Protocols	
Video Streaming	RTP
Audio Streaming	RTP, up to 7.1 channels AES67, up to LPCM 7.1 channels
Addressing	DHCP, static
Encryption	AES-128
QoS Tagging	RFC 2475
Discovery	Multicast DNS, LLDP, SAP
Management	HTTPS, SSH, Telnet, and WebSockets with TLS
Authentication	IEEE 802.1x: PEAP/MSCHAPv2 or EAP-TLS
IP Multicast	IGMPv2 and IGMPv3 support

Graphics Features	
Text Insertion	Adjustable height/width, scrolling (speed, direction, or static), iterations (up to infinite), positioning, and adjustable color and alpha (transparency) channels.
Slate / Logo Insertion ⁽⁵⁾	PNG file format, adjustable aspect ratio (keep or stretch), horizontal/vertical size, screen position; slate mode can be set to off, manual (image always displayed, superimposed on the source signal, and will remain if source signal is lost), auto (image will only be displayed when source signal is lost).

Control	
CEC	Supported and triggered from control systems and OmniStream encoders
RS-232	Device control and configuration; supports baud rates from 2400 to 115200 Bidirectional pass-through from control system to network Bidirectional TCP Proxy (RS-232 commands over IP)
IR	Pass-through from control system to network Pass-through from network to control system

Connectors	
HDMI	1 - Type A, 19-pin, female, locking
ETHERNET ⁽⁶⁾	1 - RJ45, 10/100/1000 Mbps
RS-232 / IR	1 - Euroblock, 6-pin (2 ports); RS-232 on port 1 only, IR on port 2 only
AUDIO	1 - Euroblock 10-pin; AUDIO IN/OUT; accepts balanced or unbalanced line
Power	1 - Euroblock, 2-pin

Indicators and controls	
PWR	1 - LED, tricolor (red, amber, green)
LINK	1 - LED, bicolor (red, green)
ID	1 - Momentary, tact-type, backlit (blue); sends an identification broadcast message over the network to any listening devices.
Reboot	1 - Momentary, tact-type

Power	
PoE	IEEE 802.3af
Consumption	Up to 12 W (w/o analog audio), up to 25 W (w/ analog audio)
External Power Supply (optional)	Input: 110 - 220 V AC, 50/60 Hz Output: 48 V DC, 0.83 A

Environmental	
Cooling System	Front-to-rear airflow, temperature-controlled fans
Operating Temperature	+14 to +122 °F -10 to +50 °C
Storage Temperature	-14 to +140 °F -10 to +60 °C
Operating Humidity (RH)	20% to 95%, non-condensing

Chassis	
Dimensions (H x W x D)	1.34 in x 8.19 in x 4.41 in 34 mm x 208 mm x 112 mm
Weight	1.5 lbs / 0.7 kg

Certification	
Device	CE, FCC, CB, RoHS
Supply	CE, FCC, cULus, CB, RCM, RoHS

Footnotes

- (1) Only supported when Video Quality Optimization is set to Video mode.
- (2) Scaling and deinterlacing are not supported at 1080i.
- (3) All VESA resolutions are 60 Hz.
- (4) External power supply is required when using the analog audio interface.
- (5) Slate insertion is limited to 1080p only.
- (6) Maximum distance per hop is 330 feet (100 meters), depending upon network configuration.

Dual-Channel Decoder

Video	
HDMI Specification	HDMI, HDCP 2.2
UHD/HD/SD	4096x2160 (DCI) @ 30/24 Hz 720x576p @ 50 Hz 3840x2160 (UHD) @ 60 ⁽¹⁾ /50/24/25/30 Hz 720x576i @ 25 Hz 1920x1080p @ 23.98/24/25/29.97/30/50 720x480p @ 59.94/60 Hz /59.94/60 Hz 720x480i @ 29.97/30 Hz 1920x1080i ⁽²⁾ @ 25/29.97/30 Hz 1280x720p @ 30/50/59.94/60 Hz
VESA ⁽³⁾	2560x1600 1366x768 1920x1200 1360x768 1680x1050 1280x1024 1600x1200 1280x800 1600x900 1280x768 1440x900 1152x768 1400x1050 1024x768
Virtual Reality	2160x1200 @ 90 ⁽⁴⁾ Hz (HTC [®] Vive)
Color Space	YUV, RGB

Decoding	
Density	Dual decoding engines
Decoding Format	VC-2 (SMPTE-2042)
Chroma Subsampling	4:4:4, 4:2:2, 4:2:0
Video Quality Optimization	User-selectable: PC Application or Video mode
Color Depth	8-bit, 10-bit, 12-bit
HDR	HDR10, HLG, Dolby [®] Vision™
Bit Rate	Supports bit rates up to 900 Mbps
Latency	0.5 frame (e.g. 1080p @ 60 Hz latency is < 8 ms between encoder and decoder) 1.5 frames in Fast Switching mode (e.g. 1080p @ 60 Hz latency is < 24 ms between encoder and decoder) Note: Unusual network configurations may increase overall latency
Output Resolution in Ultra-Fast Switching Mode	1080p @ 60 Hz (1 channel), 1080p @ 30 Hz (2 channels)

Audio			
Pass-through	LPCM 2.0 LPCM 5.1 LPCM 7.1	Dolby® Digital Dolby Digital Plus Dolby TrueHD	Dolby Atmos® DTS® DTS-HD Master Audio™
Down-mixing	Multichannel LPCM to two-channel LPCM		
Sample Rate	32 kHz, 44.1 kHz, 48 kHz, 88.2 kHz, 96 kHz, 176.4 kHz, 192 kHz		
Bit Depth	Up to 24-bit		
Analog audio ⁽⁴⁾	Balanced output: +4 dBu nominal gain, +20 dB headroom Frequency response: 20 Hz to 20 kHz, ± 0.5 dB Output impedance: 150 Ω Stereo channel separation: > 90 dB THD+N: < 0.03% at 20 Hz to 20 kHz SNR: > 90 dB at 1 kHz, zero clipping @ 0 dBFS, unweighted		

Protocols	
Video Streaming	RTP
Audio Streaming	RTP, up to 7.1 channels AES67, up to LPCM 7.1 channels
Addressing	DHCP, static
Encryption	AES-128
QoS Tagging	RFC 2475
Discovery	Multicast DNS, LLDP, SAP
Management	HTTPS, SSH, Telnet, and WebSockets with TLS
Authentication	IEEE 802.1x: PEAP/MSCHAPv2 or EAP-TLS
IP Multicast	IGMPv2 and IGMPv3 support

Graphics Features	
Text Insertion	Adjustable height/width, scrolling (speed, direction, or static), iterations (up to infinite), positioning, and adjustable color and alpha (transparency) channels.
Slate / Logo Insertion ⁽⁵⁾	PNG file format, adjustable aspect ratio (keep or stretch), horizontal/vertical size, screen position; slate mode can be set to off, manual (image always displayed, superimposed on the source signal, and will remain if source signal is lost), auto (image will only be displayed when source signal is lost).

Control	
CEC	Supported and triggered from control systems and OmniStream encoders
RS-232	Device control and configuration; supports baud rates from 2400 to 115200 Bidirectional pass-through from control system to network Bidirectional TCP Proxy (RS-232 commands over IP)
IR	Pass-through from control system to network Pass-through from network to control system

Connectors	
HDMI	2 - Type A, 19-pin, female, locking
ETHERNET ⁽⁶⁾	2 - RJ45, 10/100/1000 Mbps
RS-232 / IR	1 - Euroblock, 6-pin (2 ports); RS-232 on port 1 and 2, IR on port 2 only
AUDIO	2 - Euroblock 10-pin; AUDIO 1 IN/OUT, AUDIO 2 IN/OUT; accepts balanced or unbalanced line
Power	1 - Euroblock, 2-pin

Indicators and controls	
PWR	1 - LED, tricolor (red, amber, green)
HDMI	2 - LED, bicolor (red, green)
LINK	2 - LED, bicolor (red, green)
ID	1 - Momentary, tact-type, backlit (blue); sends an identification broadcast message over the network to any listening devices.
Reboot	1 - Momentary, tact-type

Power	
PoE	IEEE 802.3af
Consumption	Up to 12 W (w/o analog audio), up to 25 W (w/ analog audio)
External Power Supply (optional)	Input: 110 - 220 V AC, 50/60 Hz Output: 48 V DC, 0.83 A

Environmental	
Cooling System	Front-to-rear airflow, temperature-controlled fans
Operating Temperature	+14 to +122 °F -10 to +50 °C
Storage Temperature	-14 to +140 °F -10 to +60 °C
Operating Humidity (RH)	20% to 95%, non-condensing

Chassis	
Dimensions (H x W x D)	1.34 in x 8.19 in x 4.41 in 34 mm x 208 mm x 112 mm
Weight	1.5 lbs / 0.7 kg

Certification	
Device	CE, FCC, CB, RoHS
Supply	CE, FCC, cULus, CB, RCM, RoHS

Footnotes

- (1) 4096x2160 (DCI) @ 60 Hz and 3840x2160 (UHD) @ 60 Hz are only supported by hardware revision C or later.
- (2) Scaling and deinterlacing are not supported at 1080i.
- (3) All VESA resolutions are 60 Hz.
- (4) External power supply is required when using the analog audio interface.
- (5) Slate insertion is limited to 1080p only.
- (6) Maximum distance per hop is 330 feet (100 meters), depending upon network configuration.

