

KONA^{LHe} Plus



Published: 1/10/13

Installation and Operation Guide

Because it matters.

AJA[®]
VIDEO SYSTEMS

Trademarks

AJA®, KONA®, Ki Pro®, KUMO®, and XENA® and are registered trademarks of AJA Video, Inc. lo Express™, lo HD™, lo™, and Because It Matters™ are trademarks of AJA Video, Inc.

Apple, the Apple logo, AppleShare, AppleTalk, FireWire, iPod, iPod Touch, Mac, and Macintosh are registered trademarks of Apple Computer, Inc. Final Cut Pro, QuickTime and the QuickTime Logo are trademarks of Apple Computer, Inc.

All other trademarks are the property of their respective holders.

Notice

Copyright © 2013 AJA Video, Inc. All rights reserved. All information in this manual is subject to change without notice. No part of the document may be reproduced or transmitted in any form, or by any means, electronic or mechanical, including photocopying or recording, without the express written permission of AJA Inc.

FCC Emission Information

This equipment has been tested and found to comply with the limits for a Class A digital device, pursuant to Part 15 of the FCC Rules. These limits are designed to provide reasonable protection against harmful interference when the equipment is operated in a commercial environment. This equipment generates, uses and can radiate radio frequency energy and, if not installed and used in accordance with the instruction manual, may cause harmful interference to radio communications. Operation of this equipment in a residential area is likely to cause harmful interference in which case the user will be required to correct the interference at his own expense. Changes or modifications not expressly approved by AJA Video can effect emission compliance and could void the user's authority to operate this equipment.

Contacting Support

To contact AJA Video for sales or support, use any of the following methods:

Mail: 180 Litton Drive, Grass Valley, CA. 95945 USA

Telephone: +1.800.251.4224 or +1.530.271.3109

Web: <http://www.aja.com/en/support/>

Email: support@aja.com

When calling for support, have all information at hand prior to calling.

Limited Warranty

AJA Video warrants that this product will be free from defects in materials and workmanship for a period of three years from the date of purchase. If a product proves to be defective during this warranty period, AJA Video, at its option, will either repair the defective product without charge for parts and labor, or will provide a replacement in exchange for the defective product.

In order to obtain service under this warranty, you the Customer, must notify AJA Video of the defect before the expiration of the warranty period and make suitable arrangements for the performance of service. The Customer shall be responsible for packaging and shipping the defective product to a designated service center nominated by AJA Video, with shipping charges prepaid. AJA Video shall pay for the return of the product to the Customer if the shipment is to a location within the country in which the AJA Video service center is located. Customer shall be responsible for paying all shipping charges, insurance, duties, taxes, and any other charges for products returned to any other locations.

This warranty shall not apply to any defect, failure or damage caused by improper use or improper or inadequate maintenance and care. AJA Video shall not be obligated to furnish service under this warranty a) to repair damage resulting from attempts by personnel other than AJA Video representatives to install, repair or service the product, b) to repair damage resulting from improper use or connection to incompatible equipment, c) to repair any damage or malfunction caused by the use of non-AJA Video parts or supplies, or d) to service a product that has been modified or integrated with other products when the effect of such a modification or integration increases the time or difficulty of servicing the product.

THIS WARRANTY IS GIVEN BY AJA VIDEO IN LIEU OF ANY OTHER WARRANTIES, EXPRESS OR IMPLIED. AJA VIDEO AND ITS VENDORS DISCLAIM ANY IMPLIED WARRANTIES OF MERCHANTABILITY OR FITNESS FOR A PARTICULAR PURPOSE. AJA VIDEO'S RESPONSIBILITY TO REPAIR OR REPLACE DEFECTIVE PRODUCTS IS THE WHOLE AND EXCLUSIVE REMEDY PROVIDED TO THE CUSTOMER FOR ANY INDIRECT, SPECIAL, INCIDENTAL OR CONSEQUENTIAL DAMAGES IRRESPECTIVE OF WHETHER AJA VIDEO OR THE VENDOR HAS ADVANCE NOTICE OF THE POSSIBILITY OF SUCH DAMAGES.



Table of Contents

| | |
|--------------------------------|-----|
| Trademarks | ii |
| Notice | ii |
| FCC Emission Information | ii |
| Contacting Support | ii |
| Limited Warranty | iii |

Chapter 1: Introduction

| | |
|---|----|
| Overview | 1 |
| Features | 2 |
| Hardware | 2 |
| Video Formats | 2 |
| KONA LHe Plus Audio | 2 |
| Software | 3 |
| Understanding Typical Workflows | 4 |
| PhotoJPEG | 4 |
| DV (DV25) | 4 |
| DV50 | 4 |
| DVCPRO HD | 4 |
| HDV | 5 |
| Apple ProRes 422 and Apple ProRes 422 HQ (SD or HD) | 6 |
| Uncompressed 8-bit | 6 |
| Uncompressed 10-bit | 6 |
| System Requirements | 6 |
| Cable Connections | 7 |
| Using the Breakout Cable and 3 BNCs | 7 |
| Using KL-box | 8 |
| About BNC Connectors | 8 |
| Connector Descriptions—Cables and KL-box | 9 |
| In This Manual | 10 |

Chapter 2: Installation

| | |
|--|----|
| Installation Overview | 11 |
| Unpacking | 12 |
| Shipping Box Contents | 12 |
| Installing the KONA LHe Plus Card into Mac Pro | 13 |
| Installing the KONA Card in a Windows PC | 15 |
| Cabling the System | 17 |
| System Video/Audio Cable Connections | 17 |
| Installing KONA LHe Plus Software | 19 |
| Mac Pro Software Installation Procedure | 19 |
| Installing KONA Software for Windows | 24 |
| Re-Installation & Repair | 29 |
| Updating KONA LHe Plus Firmware | 30 |
| Genlock and Your System | 32 |

Chapter 3: Operation

| | |
|---|----|
| Using KONA LHe Plus with Professional Video /Audio Software | 33 |
| Using The AJA Control Panel | 33 |

| | |
|---|--------|
| Control Panel Basics | 33 |
| Control Screen | 37 |
| Formats Screen | 39 |
| Input Select Screen | 41 |
| SDI Output Screen | 42 |
| Analog Out Screen | 44 |
| Video Setup Screen | 45 |
| Audio Setup Screen | 46 |
| Conversion Screen | 47 |
| DS Keyer Screen | 48 |
| Timecode Screen | 49 |
| Presets Screen | 51 |
| Firmware Screen | 52 |
| Info Screen | 53 |
| Who is Controlling KONA? | 53 |
| Using Multiple AJA Products | 55 |
| Notes on using multiple AJA Products: | 55 |
| Using 8-bit Versus 10-bit Video | 56 |
| Chapter 4: Troubleshooting | |
| If You Run Into Problems | 57 |
| Updating Software | 58 |
| Support | 58 |
| Appendix A: Specifications | |
| Video Formats | 59 |
| Video Input Digital | 59 |
| Video Input Analog | 59 |
| Video Output Digital | 59 |
| Video Output Analog | 60 |
| Audio Input Digital | 60 |
| Audio Input Analog | 60 |
| Audio Output Digital | 60 |
| Audio Output Analog | 61 |
| Down-Conversion | 61 |
| Machine Control | 61 |
| Index | 63 |

Chapter 1: Introduction



Overview

The AJA KONA LHe Plus supports both HD/SD analog and digital I/O for video and audio, providing maximum capability for both Mac OSX and Windows 7 workstations. KONA LHe Plus simplifies integrating analog and digital signals into a single workflow and multiple output options to ensure you can deliver whatever formats are required.

KONA LHe Plus offers:

- 10-bit or 8-bit uncompressed video I/O
- Two-channel AES digital audio and eight-channel SDI embedded digital audio I/O
- Analog composite, S-video or SD/HD component video I/O
- Two-channel balanced analog audio I/O
- 10-bit quality hardware down-conversion from HD to SD.

KONA LHe Plus provides improved performance with third-party applications, such as Adobe CS6 and Avid Media Composer v6. AJA's renowned OS X and Windows software and application integration is included. KONA LHe Plus is also fully extensible via an optional 1RU breakout box.

KONA LHe Plus supports DV25 and DV50 using the DVCPro codec, and JPEG. DVCProHD, HDV, and Apple RT Extreme are all supported—and even accelerated by onboard hardware.

Features

The KONA LHe Plus card offers a large number of unique features for optimum quality, ease of use, and support for a wide variety of workflows and environments. KONA LHe Plus provides flexible standard definition and high definition capture and playback, a hardware down-converter for working in mixed SD/HD environments—and it supports both analog and digital audio/video I/O.

Hardware

- 10-bit uncompressed SD/HD QuickTime capture card
- 12-bit HD Analog Component I/O
- 12-bit SD Analog Component/Composite/S-Video I/O
- 10-bit hardware HD-to-SD down-conversion
- DVCPProHD hardware acceleration
- HDV hardware acceleration
- Dynamic RT Extreme hardware acceleration
- One SDI or HD-SDI Input
- Two independent SDI/HD-SDI outputs
- 2-channel analog balanced XLR audio I/O
- 2-channel AES XLR audio I/O
- 8-channel SDI embedded audio I/O
- HD/SD genlock on analog video inputs
- RS-422 Machine Control
- compatible with most professional high-end editing applications
- Cables standard
- Optional KL-box Breakout Box—provides rack mounting and flexible easy I/O (KL-box cabling is included with the KL-box). When ordering, specify a KL-box for the KONA LHe Plus since it uses a unique cable.
- 3-year warranty

Video Formats

For a complete list of video formats that KONA LHE Plus supports, refer to [“Video Formats” on page 59](#).

KONA LHe Plus Audio

KONA LHe Plus supports two-channel 24-bit 48kHz AES audio via XLR connections, and eight-channel embedded 24-bit 48kHz audio over the same single SDI connection as the video. If you are using a digital deck—you’ll have the proper connections to the deck.

For analog audio, KONA LHe Plus provides two-channel balanced audio input and output. If you purchase the optional KL-Box breakout box, you also get two-channel unbalanced audio output (RCA jacks).

KONA LHe Plus also features AES input sample rate conversion; this feature eliminates the requirement for audio source synchronization. Sample rate converters auto-lock to any AES input, 32-96KHz, and then convert it to 24 bit 48KHz audio, perfectly locked to internal KONA LHe Plus video. Sample rate conversion is done at very high quality (over 120db THD).

Software

On a Mac

AJA KONA for Mac drivers are optimized for use on OS X, with applications and advanced AJA hardware capabilities controlled easily at-a-glance in the application you're using. KONA for Mac software integrates within the native environment where used – whether Avid Media Composer, Apple Final Cut Pro, Adobe Creative Suite, Autodesk Smoke for Mac, or a wide array of other Mac applications.

Supported applications include:

- Avid® Media Composer® 6, Symphony® 6, and NewsCutter® 10
- Apple Final Cut Pro X
- Adobe Creative Suite
- Autodesk Smoke® for Mac

The KONA Desktop feature allows broadcast design elements to be viewed with the proper aspect ratio and color depth on a broadcast monitor via the KONA card. KONA Desktop is available on the entire range of KONA cards, supporting Adobe After Effects, Photoshop, Apple Motion, Autodesk Smoke for Mac and more. Powerful AJA utilities, Easy Setups, and plug-ins round out the Mac environment, providing support for all popular Mac application workflows.

On a PC

KONA for PC software allows Windows to access the hardware power of your KONA within major editing and graphics applications. Other software vendors have also provided integrated support for KONA in their own PC applications through direct collaboration with AJA. Choose the right KONA card for any format you need, including DPX, Cineon, TGA, TIFF, BMP, AVI and QuickTime. You can playback and master material, at a variety of frame rates, on a high-resolution widescreen monitor or digital projector. Custom AJA software allows full control over your playback, parameters are clearly laid out, including provisions for choosing a user-specified LUT. Supplied AJA plug-ins integrate your KONA card into a variety of graphics/visual-effects software applications to make operations even easier to use. Using AJA plug-ins, sophisticated features appear as if they were native to the software application user interfaces.

Directly supported applications include:

- Avid® Media Composer® 6, Symphony® 6, and NewsCutter® 10
- Adobe Premiere® Pro
- Adobe After Effects®
- Adobe Photoshop®
- Sony® Vegas®
- Eyeon Fusion®

KONA LHe Plus users will also find the powerful AJA Control Panel automatically installed with their KONA package. The AJA Control Panel provides easy I/O configuration monitoring, audio/video source selection, conversion and control of KONA within the overall MacOS or Windows 7 environment.

Available Utilities from AJA include: AJA Utilities: AJA TV, VTR Xchange, AJA System Test, AJA DataCalc, AJA QTtoDPXtranslator, and AJA DPXtoQTtranslator.

Understanding Typical Workflows

KONA LHe Plus allows more workflow flexibility than ever before. Users can independently select different formats for capture and storage media, while also outputting to an array of analog and digital uncompressed formats—with all outputs active simultaneously. Capture can range from analog, DV, or SD and HD digital uncompressed. Media can be stored on disk as:

- offline quality at low bit rates
- on-line quality at moderate bit rates
- or with the highest quality as 8 or 10 bit uncompressed SD and HD

As quality and codecs improve, the lines between offline and online are blurring. For example, with the Apple ProRes 422 codec, native HD editing in that codec is now possible, providing very high quality results (true HD editing) at very low data rates.

Following are summaries of the most common codecs used in various workflows, providing data rates and relative quality levels. Some workflows require a RAID array and some will work using the host Apple computer's internal system drive (as noted where supported).

PhotoJPEG

Data rate: approximately 1-3 MB/second standard definition or high definition—supported by internal system drive

Quality: Very Good

The PhotoJPEG codec offers excellent compressed media for near on-line quality at low data rates. PhotoJPEG can use full-raster 4:2:2 sampling. KONA LHe Plus allows PhotoJPEG monitoring and output in both SD and HD and can capture from almost any HD or SD input, directly to PhotoJPEG media.

DV (DV25)

Data rate: 3.13 MB/second (megabyte/second) standard definition only—supported by internal system drive

Quality: Good

DV is commonly input to an Apple computer via FireWire. KONA can capture directly to DV compressed media from an uncompressed SDI source. For devices without FireWire (IEEE1394 or i.Link) connections, this allows the user to capture to this low data rate/good-quality codec. While DV does offer good quality, it has lower chroma resolution compared to DV50, JPEG, or uncompressed. The KONA card can convert DV projects to Uncompressed, in real time, for monitoring and output even if the footage is not captured using the KONA card.

DV50

Data rate: 6.26 MB/second standard definition only—supported by internal system drive

Quality: Very Good

Panasonic DV50 standard definition codec. DV50 is a 4:2:2 compressed format and has higher chroma resolution than DV25. As with DV25, KONA can convert DV50 projects to uncompressed, in real time, for monitoring and output. KONA can capture from its SDI input, directly to DV50 compression.

DVCPRO HD

Data rate: 12 MB/second high definition—supported by internal system drive

Quality: Excellent

KONA LHe Plus has hardware support for capture from HD-SDI to the DVCPRO HD codec. KONA's hardware also takes some of the DVCPRO HD codec processing load off the CPU, allowing more computer processor time for Dynamic RT.

HDV

Data rate: 19 MB/second high definition 720p, 25 MB/second high definition 1080i—supported by internal system drive

Quality: Excellent

You can use KONA LHe Plus to convert HDV projects to uncompressed—in real time—for monitoring and/or output. KONA LHe Plus can capture uncompressed from any input, directly to HDV media. The KONA LHe Plus advanced scaling engine takes the native frame (long GOP 1440 HD) and outputs it via hardware—in real time. Precision AJA circuitry re-sizes the video to proper 1920 x 1080, providing quick playback of HDV for monitoring and recording.

HDV captures HD images via MPEG2 compression and allows for recording the signal to a MiniDV tape. This MPEG2 compression is similar to a DVD (although DVD is a program stream vs. HDV's transport stream and HDV uses a constant bit rate whereas DVDs use variable bit rates). The issue for post production is that the HDV transport stream is based around a long-GOP structure (group of pictures) which produces images based on information over a section of time, via I, P and B frames; Intraframes, predicted frames and bi-directional frames. Formats that do not use this scheme treat frames as individual units, as in the progressive formats where a frame truly is a frame, or as interlaced frames where two fields create the image. Sometimes we refer to these formats in contrast to MPEG formats, as I-frame formats where frames can be easily defined as individual.

Since the frames of HDV have the long GOP structure to define them, herein lies the problem for post-production; how can we work with the material if we must know what lies before, after and during? Luckily, the transport stream MPEG2 can be transmitted over IEEE1394 (aka FireWire). This means that the compressed HD material can be transferred into systems with the appropriate hardware and software. While this seems like a simple solution for post-production, it means that the footage must be brought into the system as a rather heavily compressed format and that the computer must continue to work with the material as a MPEG2 transport stream, which is incredibly processor intensive for the computer.

How does the AJA KONA LHe Plus card connect to HDV and digitize material to uncompressed HD files for editing—or at the very least, to a lightly compressed I-Frame HD format? The answer to this is provided in a feature common to many HDV devices: analog HD output via component video. The component connectors on JVC cameras and decks, along with Sony cameras and decks, allows for the output of the long GOP MPEG2 data as a standard HD video format such as 720P in the JVC products—or 1080i in the Sony products.

Since the KONA LHe Plus has the ability to digitize analog HD signals, the analog component output of the HDV devices can simply be connected to the KONA inputs. Note that HD signal cannot be transported over composite or S-Video (Y/C) cables, so the HDV device must have an analog component HD output. The KONA LHe Plus also has the ability to ingest analog audio, so the analog audio outputs of the HDV devices can be sent to the KONA card as well. (Also note that these analog audio outputs on the HDV devices are usually unbalanced RCA connections where the KONA card uses balanced XLR style connection so some sort of audio level correction device, such as a mixer or a stand alone active interface amplifier, should be used for accurately attenuated audio.)

Finally, you will want to control your device. Where all of the video, audio and timecode information moved over the FireWire cable, now you are dividing those tasks. Device control is the most difficult to configure for HDV devices because so few HDV devices have implemented any form of device control other than IEEE1394. The one notable exception is the JVC BR-HD50 HDV deck which has a remote serial port for RS422 protocol and device control. Check the KONA LHe Plus support area on the AJA website for a whitepaper on HDV, which gives details on using KONA LHe Plus with various HDV equipment.

Note: direct capture into HDV media on the LHe is not possible. Direct capture into the LHe can only be done using uncompressed, DVCPRO HD, or Pro Res. Regarding ProRes 422, capturing HD resolution ProRes 422 from an HD source requires a Mac Pro with an Intel Xeon processor.

Apple ProRes 422 and Apple ProRes 422 HQ (SD or HD)

Data rate: Approximately 18 MB/second ProRes 422, Approximately 31 MB/second ProRes 422 HQ— supported by internal system drive or attached storage

Quality: Excellent, broadcast quality

Captured media is virtually indistinguishable from pristine uncompressed sources. Better yet, ProRes maintains the quality during editing, surviving multiple encoding/decoding generations without degradation. It was designed by Apple for editing, rather than as a transmission/distribution codec as are most popular codecs. Some of the advantages include:

- Full-size 1920-by-1080 and 1280-by-720 HD resolutions.
- Full-size 720-by-486 and 720-by-576 SD resolutions.
- 4:2:2 chroma sampling. Provides precise compositing and blending at sharp saturated-color boundaries.
- 10-bit sample depth. Preserves subtle gradients of 10-bit sources (perfect for green-screen compositing, graphics or color correction) with no visible banding artifacts.
- I frame-only encoding. Ensures consistent quality in every frame and no artifacts from complex motion.
- Variable bit-rate (VBR) encoding. “Smart” encoding analyzes the image and allocates more bits to complex frames.
- Low data rate requirements make for more storage options and require less drive space to store high quality video.

Uncompressed 8-bit

Data rate: 21 MB/second standard definition, or 100-124 MB/second high definition (see later “Storage Capacity” chart in Chapter 1 for the various transfer rates per format)—requires SCSI, Fibre Channel, or ATA drive array

Quality: Excellent

The native storage format for KONA LHe Plus is uncompressed media which offers the highest quality available. Capturing in uncompressed results in no compression artifacts, and video is sampled over the full raster at a 4:2:2 rate.

Using uncompressed maintains a higher quality in your project from capture all the way through effects rendering. KONA LHe Plus supports capture of uncompressed through any of its inputs, and uncompressed projects are output to all of its outputs simultaneously.

Uncompressed 10-bit

Data rate: 28 MB/second standard definition, or 133-166 MB/second high definition—uncompressed 10-bit requires SCSI, Fibre Channel or SATA drive arrays.

Quality: Excellent, very high quality

Offering all the benefits noted previously for 8-bit uncompressed, 10-bit additionally offers the very highest quality available. With 10-bit media video quality is second to none. For more information on this subject, please see the topic at the end of Chapter 4: *Installation and Configuration*, titled “Using 8-bit Versus 10-bit Video.”

System Requirements

AJA Video recommends that your system meet minimum hardware and software requirements to achieve a satisfactory level of performance when operating it. System requirements are subject to change as new versions of operating systems, QuickTime, and workstations become available. For the most up-to-date Minimum System Requirements see “[Installation Overview](#)” on page 11.

Cable Connections

KONA LHe Plus offers unsurpassed cable connectivity for a video/audio capture card. Connections are made via a supplied breakout cable and three BNCs on the KONA LHe Plus Card endplate.

Using the Breakout Cable and 3 BNCs

The breakout cable supports:

- Reference Input (BNC)
- Component/Composite/S Video Input (3x BNC)
- Component/Composite/S Video Output (3x BNC)
- AES In (2x XLR)
- AES Out (2x XLR)
- Balanced Audio In (2x XLR)
- Balanced Audio Out (2x XLR)
- RS-422 Machine Control (9 pin D)

The three BNCs on the KONA LHe Plus Card endplate additionally provide:

- Standard and High-definition SDI input (BNC)
- 2 SDI outputs (2x BNC, independent outputs)

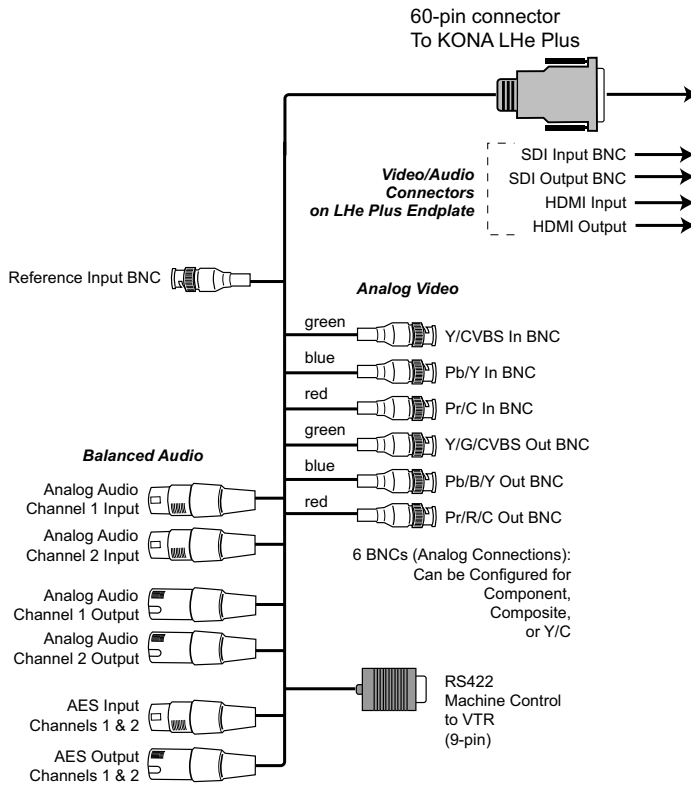

KONA LHe Plus Breakout Cable

Using KL-box

The KL-box attaches to the KONA LHe Plus card via cables that attach to the back of the KL-box. These cables are supplied with the KL-Box (one 60-pin to 60-pin, and one 3-BNC to 3-BNC). When you purchase the optional KL-Box, you get two-channel unbalanced audio output (2 RCA Jacks)—not available with the standard cable.

Note: When ordering a KL-Box, ensure that you specify one configured for the KONA LHe Plus. The KL-Box is also available for other KONA models but may use a different cable set. Separate AJA part numbers exist for each configuration, so ensure your dealer supplies you with the correct one.

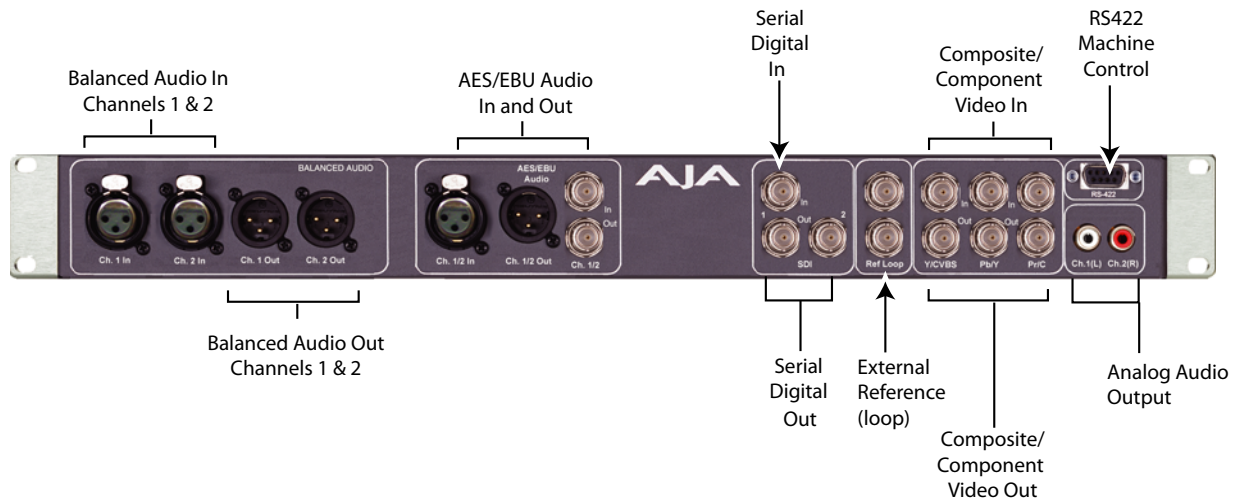

AJA KL-box Panel Connectors

About BNC Connectors

Although most video professionals are used to BNC connectors, you may not have seen them if you've been using primarily desktop video equipment. BNC connectors ensure a positive connection by the act of locking the connectors together via pins in one connector that fit into slots in the corresponding connector.

To make a BNC connection, slide the cable connector over the panel connector and then when seated, rotate the barrel of the cable connector 90° clockwise until the connectors are locked together. When properly locked, the cable cannot accidentally be pulled out.

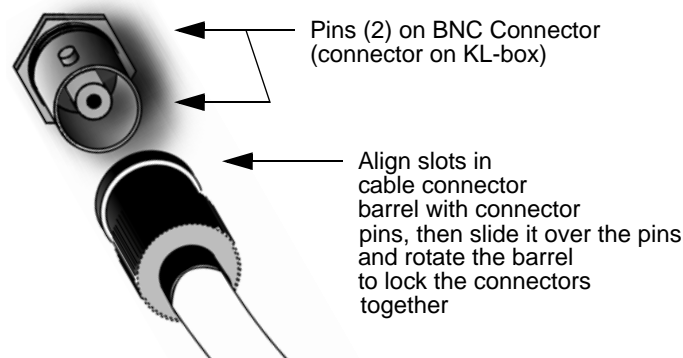

Connector Descriptions— Cables and KL-box

Connectors on the standard cable set are labelled as to their function for easy installation and maintenance. Similarly, connectors on the optional KL-box are also labelled.

SDI Input and Outputs

BNC connectors are provided on the KONA LHe Plus card endplate for one SD-SDI or HD-SDI input and two SDI outputs (independent of the input). The SDI input and outputs support video and embedded 24-bit digital audio. Use SDI wherever possible for the best quality 10-bit uncompressed video input, capture and output. If peripheral equipment has a variety of inputs/outputs, look to see if it has SDI I/O, and use it where possible. Most high-end professional broadcast equipment supports SDI (VTRs, cameras, media storage servers, etc.).

2-Channel Digital AES/EBU Audio Inputs And Outputs

One female XLR connector is provided for the channel 1 and 2 inputs, while a male XLR connector carries channel 1 and 2 outputs. AES/EBU signals are handled internally as 24-bit digital. The optional KL-box also provides XLR audio connections on the front panel.

Note: AES XLR connections are digital and cannot be used with analog equipment having XLR connectors.

Analog 2 Channel Balanced Audio

Two sets of analog XLR connectors, one for each channel, support balanced audio connections. Male XLRs are provided for outputs and female XLRs are provided for inputs. Balanced audio (differential) connections provide better analog audio quality over longer cable runs. Most professional quality VTRs and audio equipment have XLR style connectors for analog audio. Analog audio signals are converted internally to 24-bit digital.

Analog 2 Channel Unbalanced Audio (KL-box only)

On the KL-box are two analog output connectors, one for each channel. These connectors are RCA-style phono jacks.

RS422 Machine Control

A female DB9 connector on the breakout cable provides connection for VTRs, camcorders, disk media servers, and other devices using RS422 SMPTE (Sony) protocol. This connector is also present on the optional KL-box. (Connector pinout is listed in Appendix A: Specifications.)

Analog Monitor Out (Component/Composite HD/SD)

Both the standard I/O cable and the optional KL-Box feature two groups of 3 BNC connectors (each) for input and output of component, composite and Y/C functions. The signals are labelled on both the cable and KL-Box connectors.

Component video signals are generally higher quality than composite, but not as high quality as serial digital (SDI).

A Note About RGB—Although RGB is used less in today's video systems, KONA LHe Plus supports it. However, because the KONA LHe Plus (and SMPTE SDI) native format is YPbPr, AJA recommends the use of YPbPr whenever possible for analog monitoring. Although component video monitors often have RGB inputs, it's better to use YPbPr when the monitor supports it. The YPbPr format provides "headroom" for "superwhite" and "superblack"—and these video levels *will be clipped* when transcoding to RGB. Also, the RGB/YPbPr transcoding involves a level translation that results in mathematical round-off error. RGB can be configured in the AJA Control Panel.

A Note About YPbPr—Component Video, or YPbPr, has been given several names over time. YUV, Y/R-Y/B-Y, and YCbCr, are just some examples. Although these various formats have some differences in levels, they are all basically the same. KONA LHe Plus uses the modern YPbPr terminology exclusively. KONA LHe Plus supports three different types of YPbPr:

SMPTE/EBU N10, Betacam (NTSC), and Betacam (NTSC Japan). These three formats differ in level only and are configured in the AJA Control Panel.

Reference Video

A single BNC on the standard KONA LHe Plus cable—or two BNC connectors on KL-box (it loops through)—allow you to synchronize KONA LHe Plus outputs to your house analog reference video signal (or black burst). If you have a sync generator or central piece of video equipment to use for synchronizing other video equipment in your studio, then connect its analog composite output here. When KONA LHe Plus outputs video it uses this reference signal to lock to. When connecting a reference video source, the locking signal should be the same format as the Primary format selected in the AJA Control Panel. It is possible in some circumstances to use an alternate format video signal as long as the basic frame rate is compatible.

In This Manual

Chapter 1 is the introduction you're reading, listing features, and system requirements.

Chapter 2 provides complete instructions for installing and configuring the AJA KONA LHe Plus card. The user is guided through unpacking, installing the card into a Mac or PC, installing KONA LHe Plus Mac or PC compatible driver software, cabling the system and then getting it up and running. Important configuration information is also provided on video settings and use of genlock/external reference.

Chapter 3 discusses operational aspects of KONA LHe Plus when used with the AJA Control Panel.

Chapter 4 discusses troubleshooting problems with your system and what to do when there's a problem you can't solve.

Appendix A presents a list of technical specifications for the product.

The remainder of the manual consists of an index section to help you rapidly find topics in the manual.

Chapter 2: Installation



Installation Overview

The installation and set up of a KONA LHe Plus is very simple. All of the steps of installation and configuration are documented in this chapter, summarized as follows:

1. Unpack the shipping box
2. If not previously installed on your Mac Pro, ensure that your third-party video editing software is installed as detailed in its user documentation.
3. For the KONA Mac installation, AJA recommends that the card be placed in Slot 3 and the Apple Expansion Slot Utility be configured so that the slot is running at x4 lane speed or higher. (The choice of x4, x4, x1 and x16 is ideal.) Refer to the AJA website at:
<http://www.aja.com/en/support/kona-system-configuration/>

For the most up-to-date Windows system requirements for KONA, consult the AJA website:

<http://www.aja.com/en/support/kona-pc-system-configuration/>

4. Install AJA KONA LHe Plus software on your computer from website download or the supplied AJA CD-ROM.
5. Cable the system audio and video sources, VTR, audio monitor, and video monitor. If you purchased the optional KL-box, then install it into an equipment rack or place it on a desk and connect its two cables to the KONA LHe Plus card. If you're instead using the standard cable set, then use those to connect equipment.

Each of these steps are explained in greater detail in the remaining pages of this chapter.

Unpacking

Shipping Box Contents

KONA LHe Plus is shipped with a CD containing system software and an Installation and User manual (a PDF on the CD), and a cable. If you purchased the optional KL-box breakout box, it ships with its own set of cables and instructions for connection to the KONA LHe Plus card.

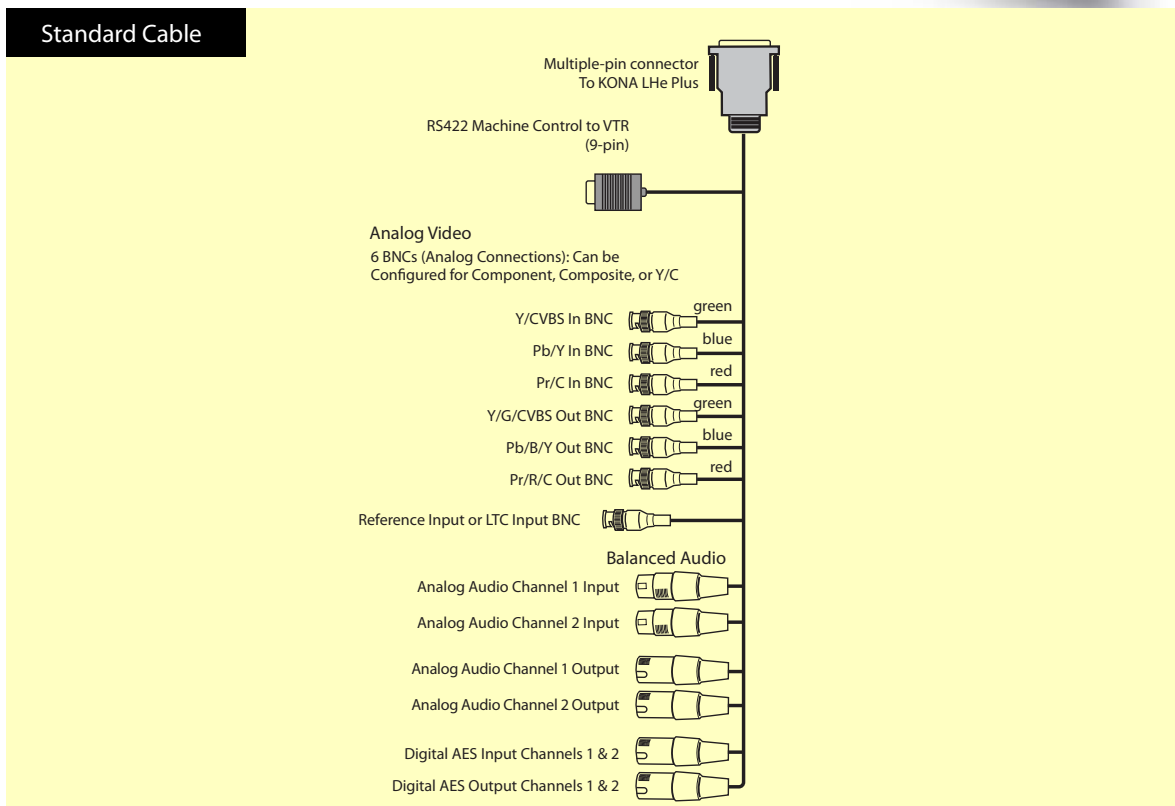
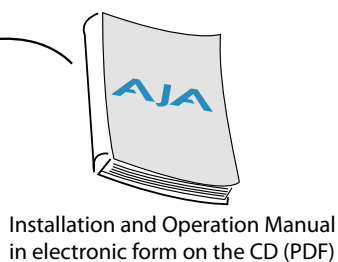
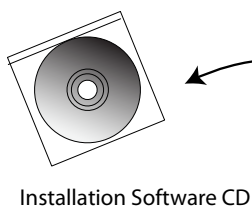
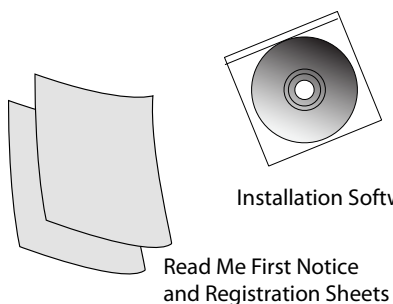

Contents, KONA LHe Plus Shipping Box

As you unpack the shipping box(es), carefully examine the contents. Ensure you received everything and that nothing was damaged during shipment. If you find any damage, immediately notify the shipping service and supply them with a complete description of the damage. AJA will repair or replace damaged items. If you find shipping damage, contact your AJA dealer or distributor for details on how to have your KONA LHe Plus repaired or replaced.

Note: Save packing materials and the shipping box. If you ever require service or move your system—use the packaging materials and box for safe shipment.

Installing the KONA LHe Plus Card into Mac Pro

1. Place the Mac Pro in a well-lit convenient area, where you will have easy access to the chassis access door.
2. Using your hand, touch the outside of the Mac Pro to discharge any static electricity you have. Remove the power cable from the back of the Mac.
3. Remove the access door as described in your Apple User Manual.



To Install:

1. Remove Screw and Cover Plate and Insert KONA Card
2. Secure KONA with Screw Removed Earlier

PCI-Express Slots

Mac Pro Cardcage Access

4. Remove the KONA LHe Plus card from its protective anti-static bag; place the card on top of the bag.



KONA LHe Plus Card

5. Visually locate the PCIe slots inside the Mac chassis. The slots are numbered along the left side. To determine which slot works best for your Mac Pro model, visit the AJA website (see ["Installation Overview" on page 11](#) for links). This web-page is updated regularly to account for Apple product line changes.

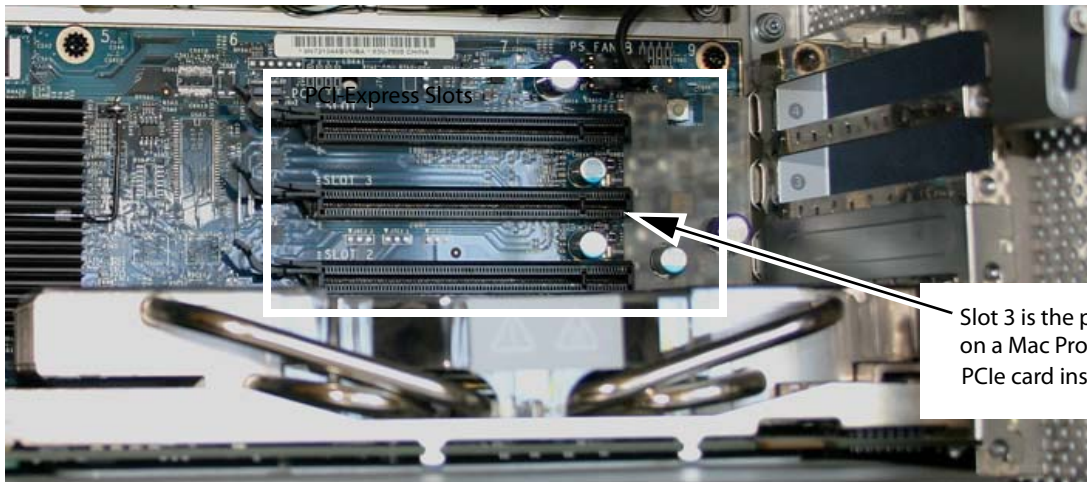

Card Slots, PCIe Mac Pro shown here

6. Remove the card edge locking plate on the right side of the card cage, using a Phillips screwdriver (it is held in place by two captive Phillips screws).
7. Carefully insert the KONA LHe Plus card by rocking it slowly into the desired PCIe slot. Ensure the card edge aligns properly with the Mac Pro's rear panel opening (where the card edge locking plate was just removed) and that it is fully seated in the slot.
8. Replace the card edge locking plate removed earlier, securing the two Phillips screws.
9. Replace the Mac Pro's access door.

Installing the KONA Card in a Windows PC

1. Place the PC in a well-lit convenient area, where you will have easy access to the chassis access door.
2. Touch the outside of the PC to discharge any static electricity in your body. Remove the power cable from the back of the PC.
3. Open the PC to gain access to the card slots as described in your Workstation User Manual.
4. Remove the KONA card from its protective anti-static bag; place the card on top of the bag.
5. To install the KONA card and RAID controller card (SCSI or Fibre Channel), refer to the AJA website for the latest installation updates at the URL provided (see [“Installation Overview” on page 11](#) for link).

Because of hardware and software changes, AJA engineers are constantly testing and grading workstation performance. The AJA website is your best source of up-to-date approved workstation configurations.

Note: Always put the RAID controller and KONA on separate PCI busses. This improves performance by reducing bus contention.

HP Z800 Workstation

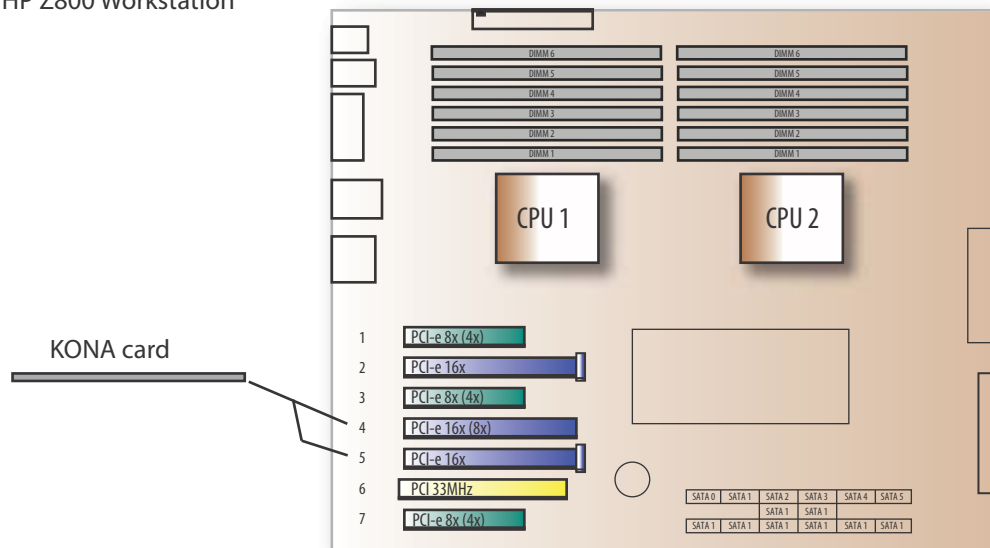

KONA Card placement in HP Z800 Motherboard

6. Open the card retainer bar on the left side of the chassis cardcage. Remove the card edge access cover from the desired slot where you will be inserting the KONA card.
7. Holding the KONA card by the card edge plate and an outside edge, carefully insert the KONA card by rocking it slowly into the slot. Ensure the card edge aligns properly with the PC's opening (where the card edge cover was just removed) and that it is fully seated in the slot.
8. Secure the card in the slot replacing the card retainer bar.
9. Replace the PC's panel/door removed in step 3.

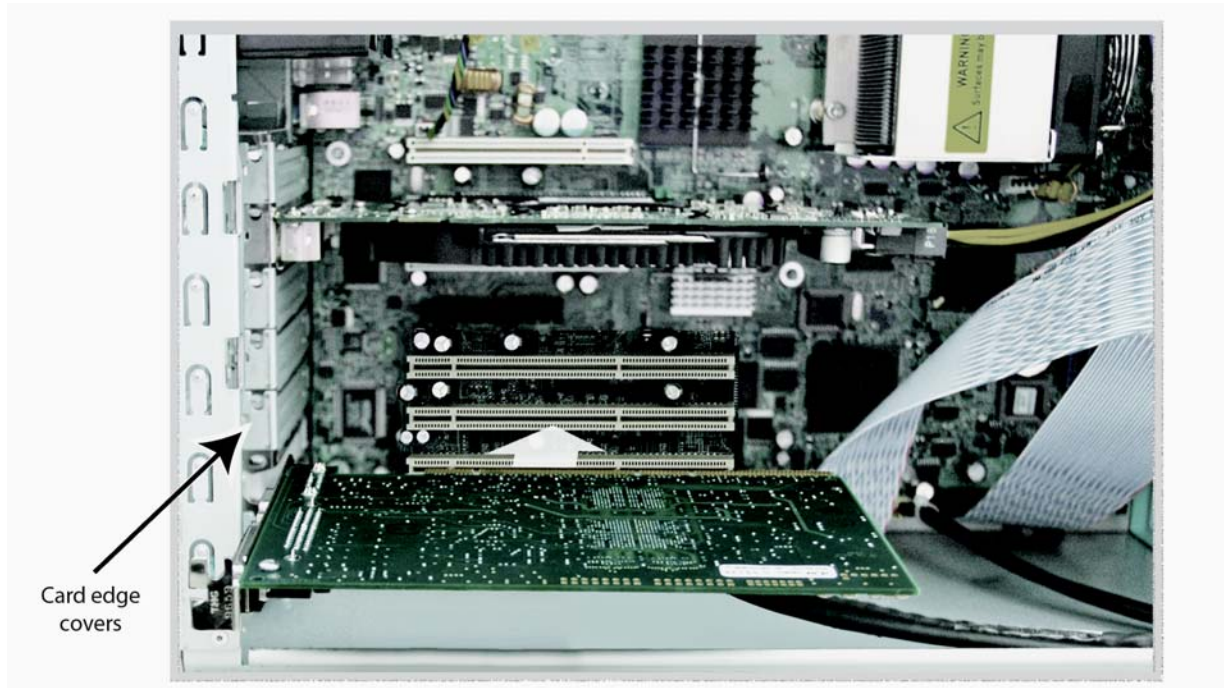

Locate the correct PCIe Slot and Insert the KONA Card (typical installation shown)

Cabling the System

System Video/Audio Cable Connections

When installing your system, you'll make video and audio input/output connections. These connectors are explained individually in chapter 2. Here, system interconnection is shown and described.

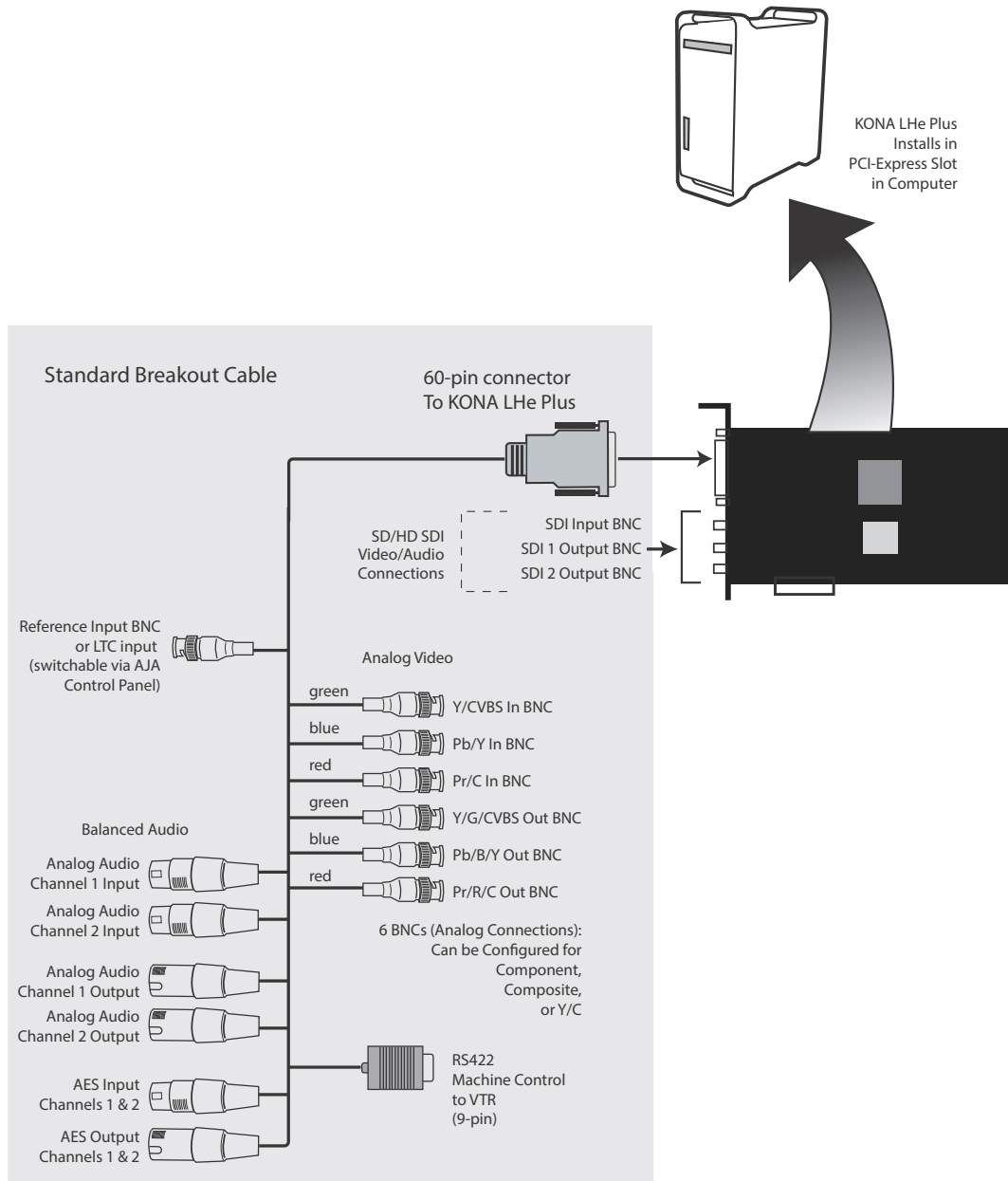

KONA LHe Plus System Using The Breakout Cable

Typical System

A figure on the following page shows typical system interconnections for a system with digital A/V sources. Your system may differ depending on VTRs, audio monitoring, and video monitoring.

1. If desired, connect your house reference sync to the KONA LHe *Ref Loop* connector (BNC). The second KONA LH Ref Loop connector on the KL-box (if used) can be connected to the VTR or terminated with a 75-ohm terminator.
2. Connect a Video Monitor to the KONA LHe *Component Analog Video Out* BNC connectors (preferred), or instead connect to a composite monitor.
3. Connect a 9-pin DB9 machine control cable between your VTR's RS422 control port and the breakout cable's *RS-422* machine control connector.
4. Connect two SDI cables between KONA LHe Plus (BNCs are on the card endplate) and your digital VTR (Digital Betacam etc.): one from KONA LH *SDI In* to the VTR SDI Out, and one from KONA LHe Plus *SDI Out* (1 or 2) to the VTR SDI In. The KONA LHe Plus SDI connections have embedded audio so the VTR must be configured accordingly.
5. If you have an AES/EBU-ready audio monitoring system, then connect the two channels of AES/EBU output from KONA LHe's XLR connectors (channels 1 and 2) to the monitoring system AES/EBU inputs. If you instead have an analog audio monitoring system, you can use either the XLR balanced audio connectors or the two RCA-style unbalanced stereo output jacks on the Optional KL-box for output.

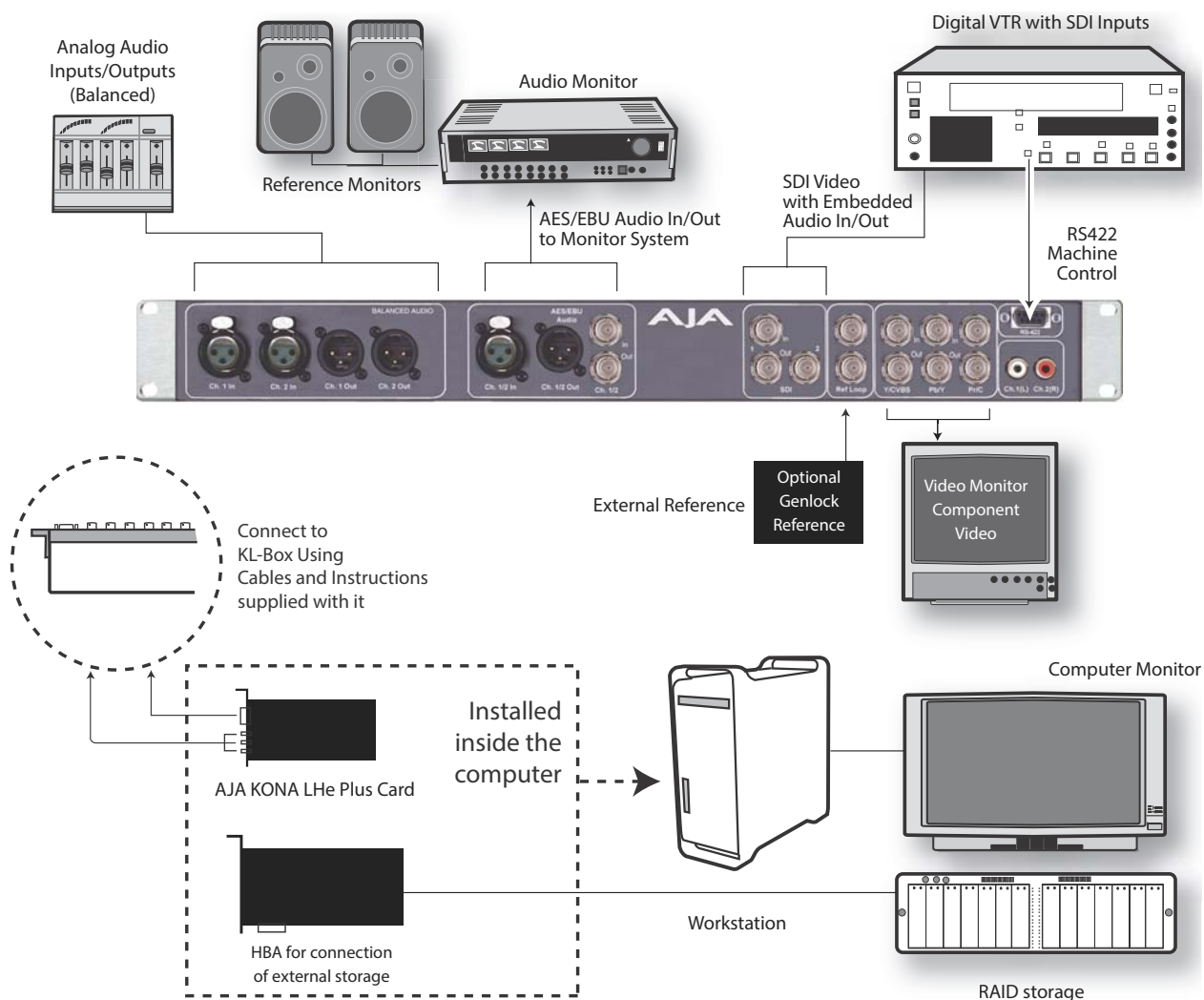

Typical System Connections—Shown with Optional KL-Box

Installing KONA LHe Plus Software

First ensure that third-party editing software is installed as detailed in its user documentation. Next, navigate to the AJA support website for a download of the very latest software for LHe Plus or use the CD-ROM supplied with your KONA card. The installation package contains the necessary software drivers and AJA Control Panel. You cannot use KONA LHe Plus with third-party applications with KONA until the AJA KONA LHe Plus software has been installed on the host computer.

Since system software updates occasionally become available on our website at:

<http://www.aja.com/en/support/downloads/>

We recommend checking occasionally for both software updates and additional product information.

Note: If your computer has previously had another video capture or multimedia card installed, ensure you remove the card and uninstall any related software before installing KONA LHe Plus. This will prevent any hardware or software conflicts.

Mac Pro Software Installation Procedure

Locate the AJA KONA LHe Plus Software— website download or CD packaged with your system. Then follow the procedure below. The system must be an Apple Mac Pro (refer to “[Installation Overview](#)” on page 11 for system requirement information).

Mountain Lion OS and Gatekeeper

Note: Before installing KONA 3G software, turn off any virus protection and security software that you may have installed on your computer. Also, with the addition of Gatekeeper functionality in Mas OS Mountain Lion, you should go to System Preferences>Security & Privacy and choose to allow *Mac App Store and identified developers*.



Mac Security & Privacy Gatekeeper Setting

1. Locate the KONA LHe Plus download package or CD icon on the OS X desktop.

2. In the window, locate the package file; it has an icon that looks like a box and has a “.pkg” or “.mpkg” suffix.
- Note:** Files ending in the “.pkg” and “.mpkg” suffix are OS X installer files. These launch the OS X installer and tell it where and what to install on your system.
3. Double-click the package to log on and begin software installation.
 4. The system will respond by asking you to authenticate who you are as currently defined on your OS X user profile. Enter the proper name and password at the Authenticate prompt; if you have multiple users defined, ensure that you log on as a user with administrator-level authority.



Log On Authenticate Prompt

5. Click on the OK button after entering a valid user and password.
6. The installer will launch and you'll see a series of installer screens.

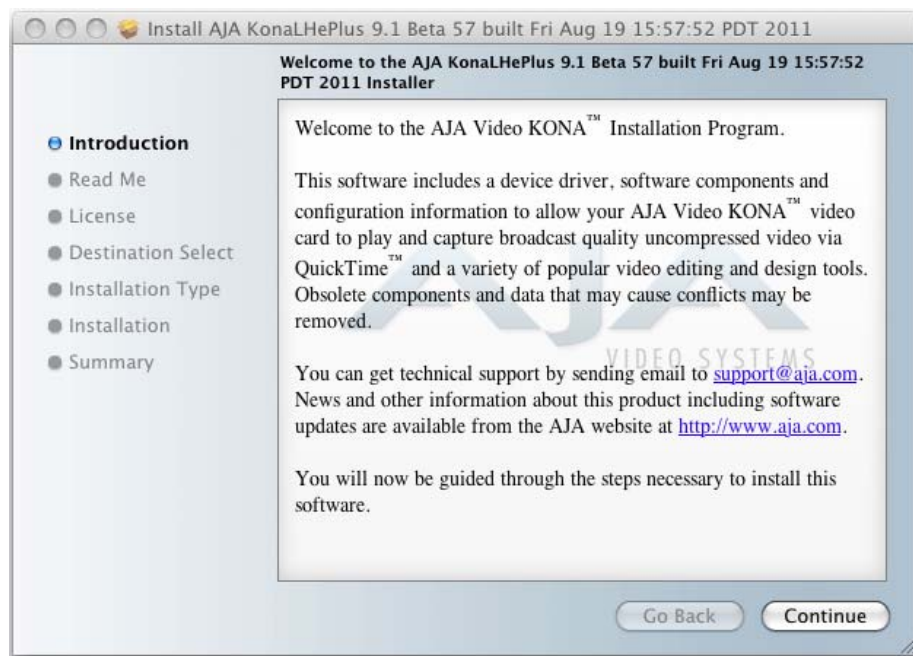

Initial Installer Screen

7. Click *Continue* to begin installation.

- The next screen lets you know that the installer will check your Mac Pro to ensure it has the hardware and software resources required (see “Installation Overview” on page 11).

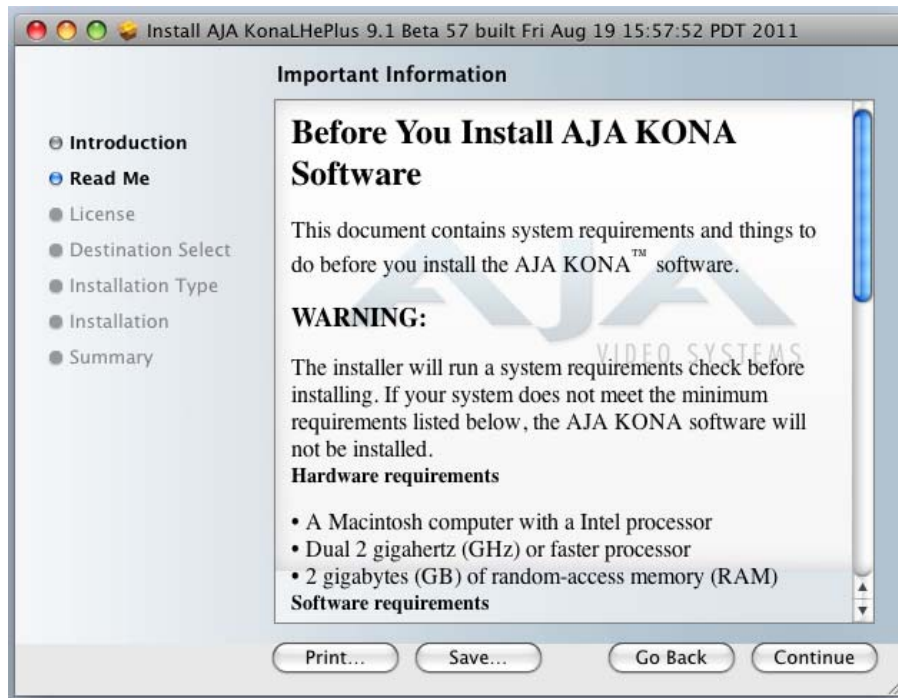

System Check Installer Screen

- Read Software License Agreement, click Continue, and Agree on the following screen.

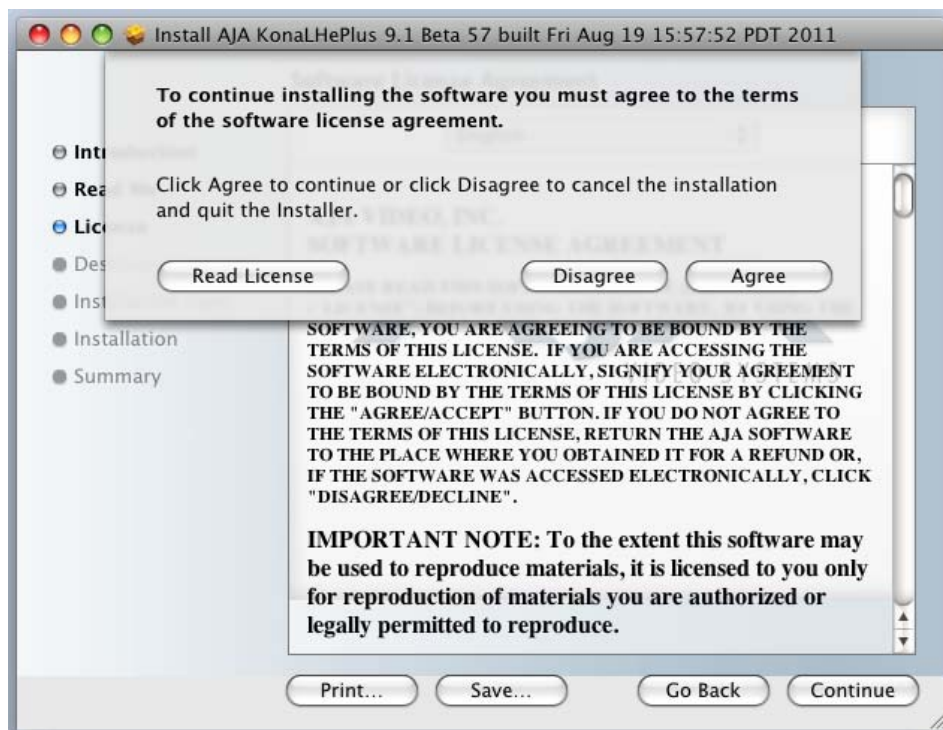

KONA LHe Plus Software License Agreement Screen

10. The next screen allows you to install the complete package of drivers and setups available or compose a custom installation.

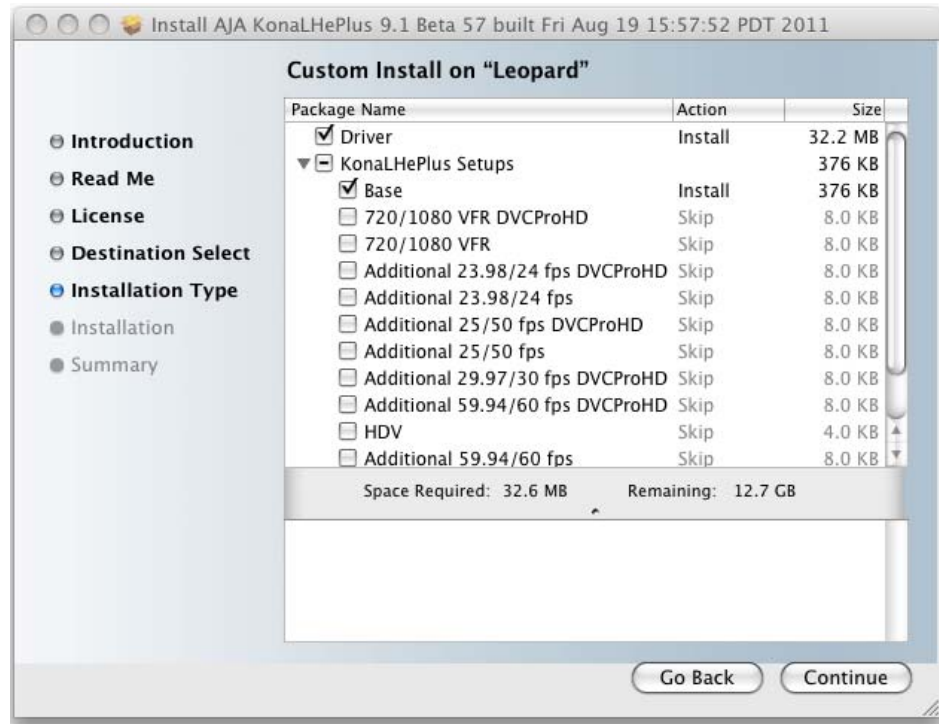

Select a Destination Drive For the KONA LHe Plus Software

11. At the next screen, click the *Install* button to place the software on the default drive or click *Change Install Location* to select a different drive.

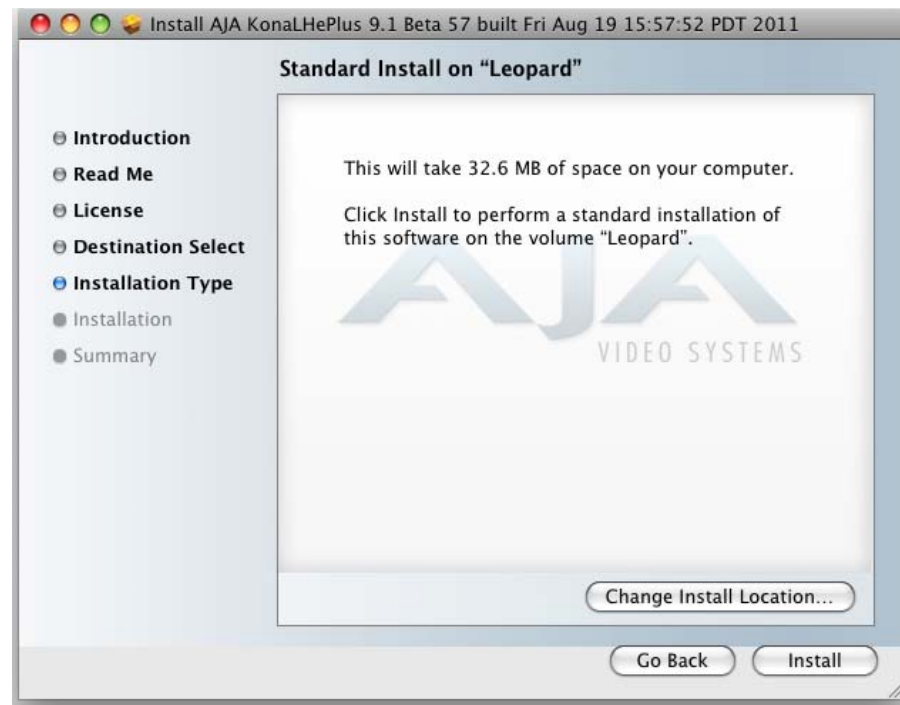

Easy Install, Installer Screen

12. A system prompt will pop up with a reminder that OS X must be restarted after installation. Click the *Continue Installation* button to proceed.

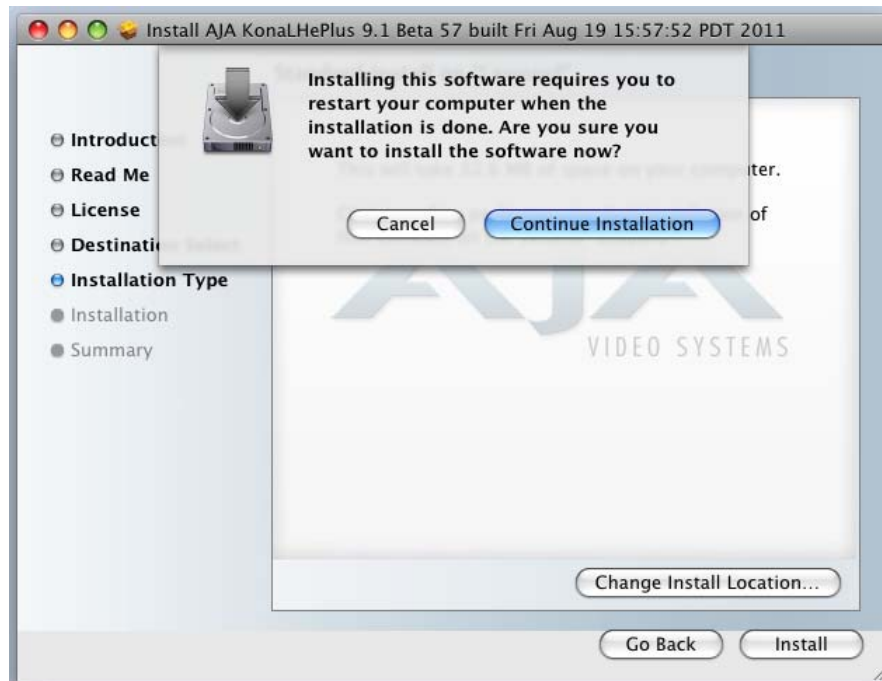

Restart OS X Reminder Prompt

The installer will run and put all the necessary KONA LHe Plus drivers, AJA Control Panel, presets and software on the desired hard drive. When it has completed installation, a final screen will be displayed announcing that “software was successfully installed.”

13. Click the Restart button to complete the installation procedure. The system will perform a software restart and be ready for use.



Final Installation Screen

Installing KONA Software for Windows

If your PC has previously had another video capture or multimedia card installed, remove the card and uninstall any related software before installing KONA. Also, always uninstall existing KONA software before installing a new version. This will prevent hardware/software conflicts.

The installation procedure is described below. You cannot use KONA with third-party applications until the AJA KONA software has been installed on the host workstation.

If you add KONA supported applications at a later date and have not previously installed the appropriate plugins, you must run the install program again selecting the appropriate application support software to be installed.

Software Installation Procedure

Locate the AJA KONA Software download or CD ROM packaged with your system and follow the procedure below to install the required software on the host system. The KONA for PC software is intended for Windows 7 64-bit workstations.

The KONA for PC 10.2 Installation Software is divided into separate installer packages containing:

- Retail Drivers and Control Panel applications
- Plugins for the various third-party applications supported.

The AJA Retail Software package must be installed first. Next, install the plugin package for your desired Application Software.

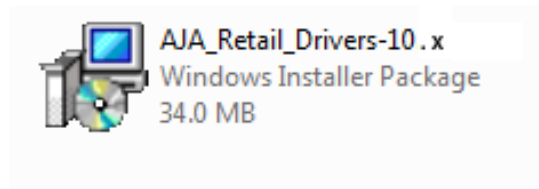

KONA for PC Retail Drivers Installer Package

Note: Before installing KONA software, turn off any virus protection and security software that you have installed on your computer.

This section describes the AJA Retail Software package installation. The subsequent installations are essentially the same but do not require restart of the computer. Refer to your specific plugin package Installation Guide.

Double-click on the download package or insert the KONA CD into the PC.

Install Wizard

The KONA installation program will launch and extract the necessary KONA drivers for installation on the desired hard drive.

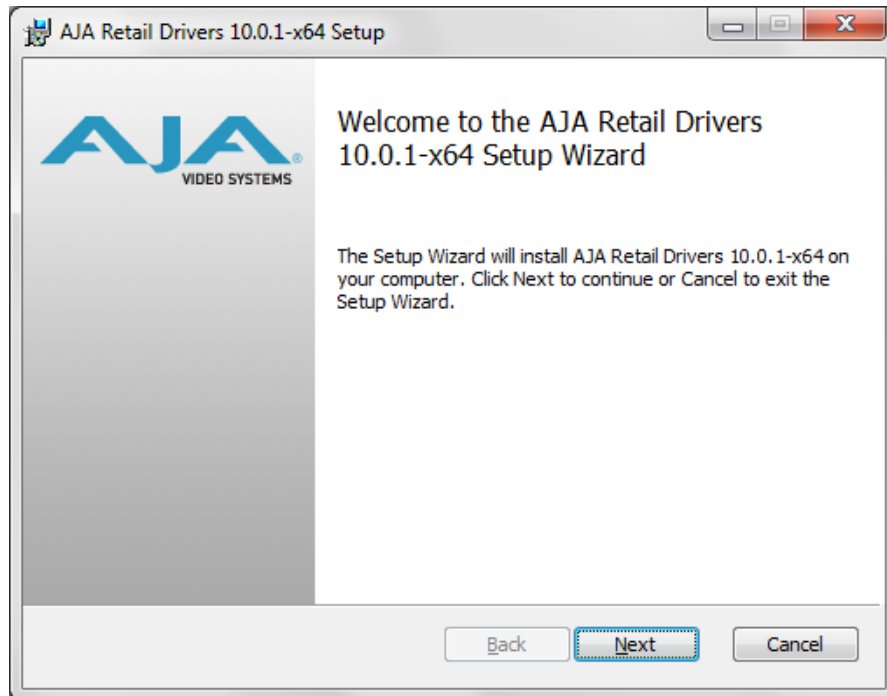

Install Wizard Welcome

When you see the Welcome page, click "Next" to view the KONA license agreement.

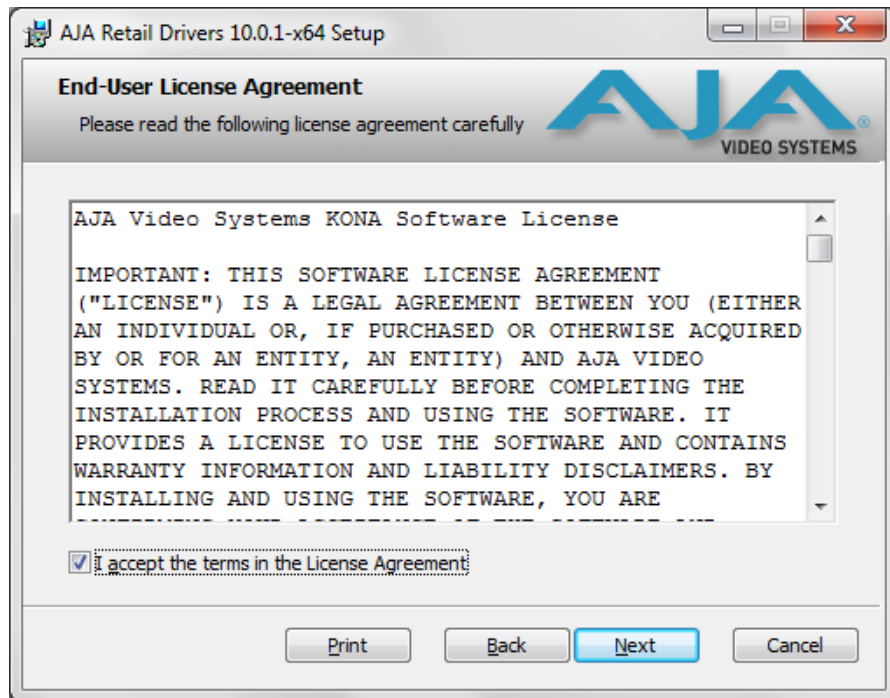

License Agreement

Read the KONA license agreement and check the Agreement box to accept. You will be asked to choose the type of installation you would like to perform.

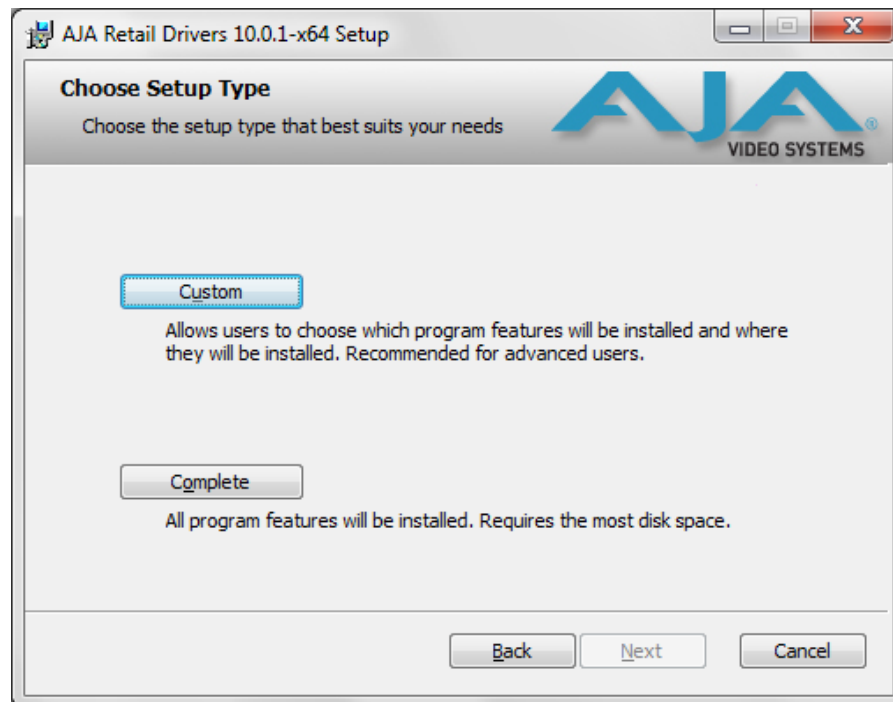

Installation Type

If you don't have all the KONA supported products installed on your workstation, you may choose to perform a Custom installation (default) and select only the software necessary for your applications. Otherwise, use the "Typical" installation. The following screens depict the more elaborate Custom installation.

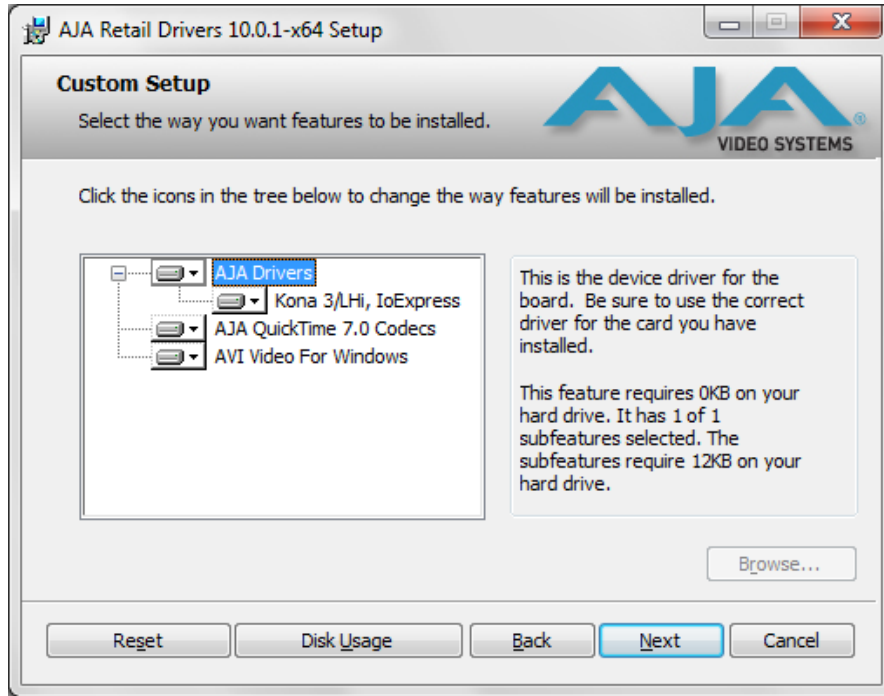

Custom Installation Menu

You may deselect an Item for installation by using the pulldown to make it unavailable.

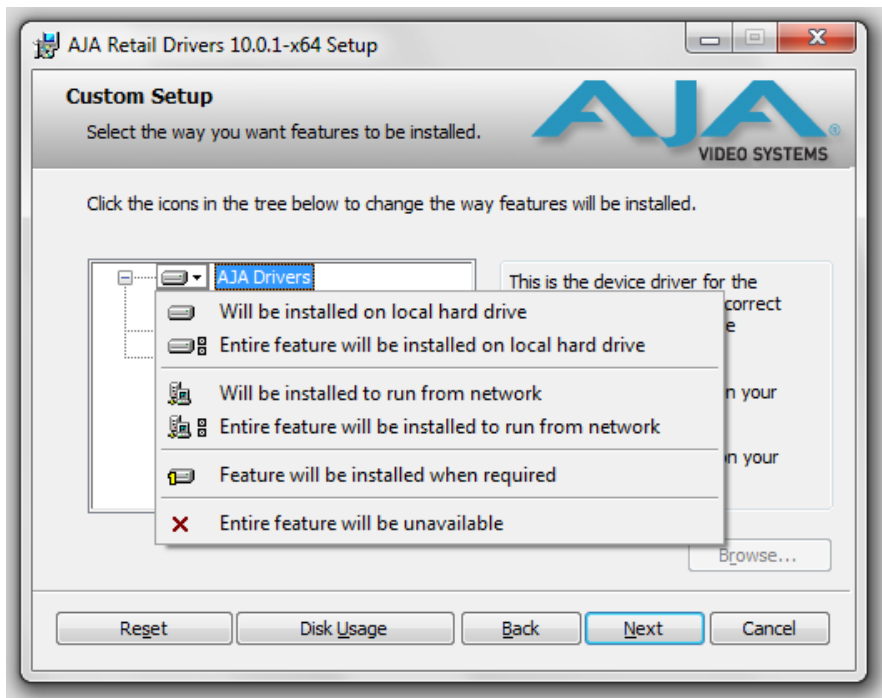

Custom Selections Pulldown Menu

Use the second level options choose the specific drivers and plugins you would like installed. Disabled selections are marked with a red X. Before clicking Next to install, you can verify your disk space availability by clicking the Disk Usage button.

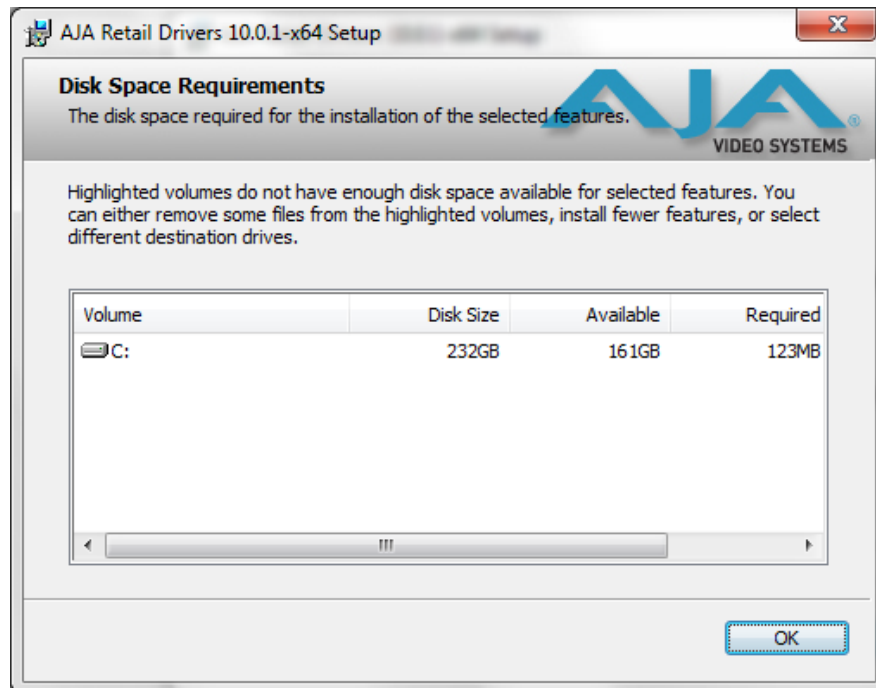

Workstation Disk Usage Display

To return to the installation click OK. Click Next to begin the installation. screen.

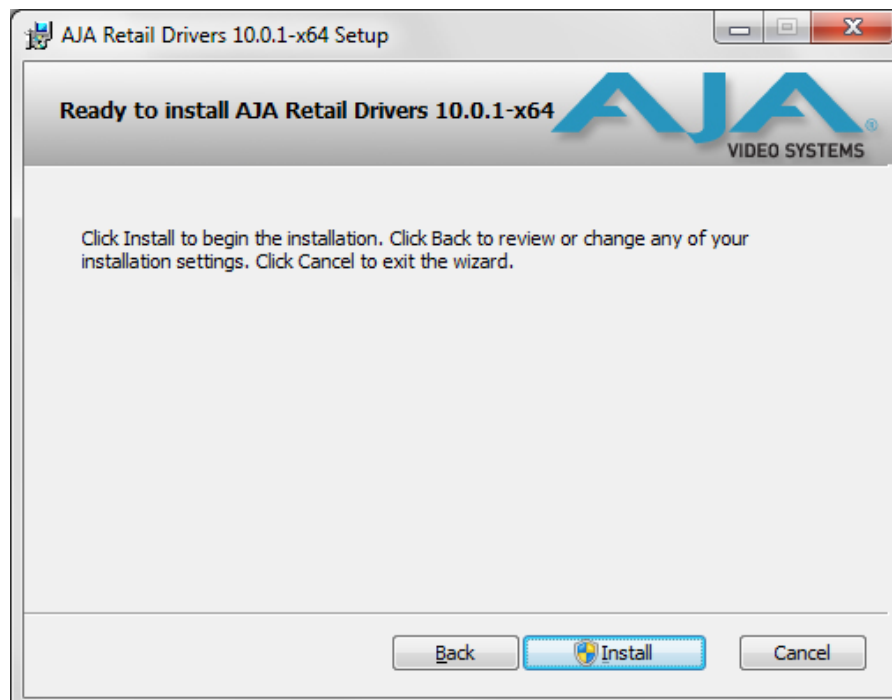

Begin Driver and Plugin Installation

When the installer has completed copying the KONA software to disk, you may see a standard Windows Logo test warning. Click on the “Continue Anyway” button to finish the installation.

When the installation is completed, a final screen will be displayed announcing that “Setup has finished installing AJA KONA on your computer.” Click on the Finish button after the installation is complete. The AJA Retail installation requires you restart the computer after installation to activate the KONA card.

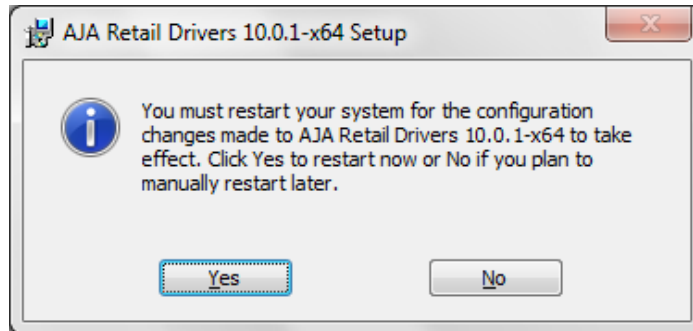

Restart Screen

You may now repeat this installation procedure for your chosen Application plugins.

Re-Installation & Repair

If you have problems running your newly installed pluggins or need to re-install to add AJA drivers or application pluggins, you can relaunch the install package and access the following window.

Note: Note: Always uninstall KONA software before running a newer version software installation package.

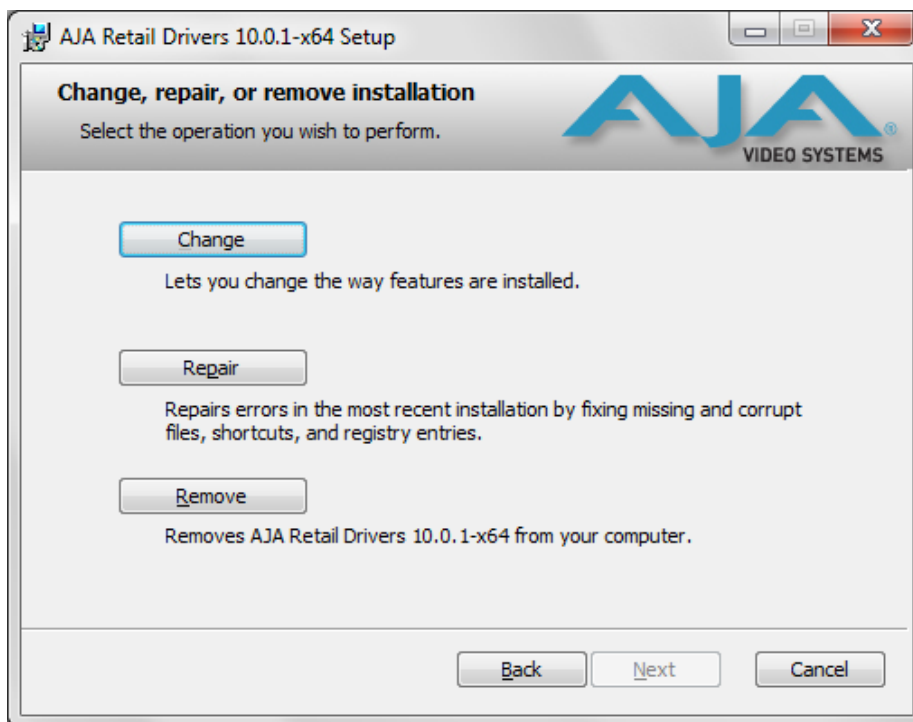

Change, Repair, or Remove Installation Menu

Updating KONA LHe Plus Firmware

When you update your KONA LHe Plus software by downloading new versions from the aja.com website, it is possible that some versions may also require a firmware update to update the software stored in non-volatile memory on the board. Always carefully read the release notes that accompany each version to be installed. The release notes will spell out all required software and hardware necessary to ensure a successful update of your KONA LHe Plus.

Follow these instructions when a firmware update is required:

1. First install the new version of KONA LHe Plus software.
2. After successfully installing the new KONA software, the AJA KONA Updater will automatically launch. (The updater application is located in the *AJA Utilities* folder.)



3. When the updater starts, the following screen will display indicating the current firmware and update firmware creation date.



Firmware Update Welcome Screen

4. Click *Update Firmware* to begin the update process. Do not interrupt the update process



Firmware Update Warning Screen

5. After the firmware installation completes, you'll be asked to **Shut Down** the computer, wait for two seconds, and then start up again.



Firmware Update Power-down Screen

Important: A **Restart** of the computer will not load the new firmware—click **Shut Down** to initiate a complete ON/OFF power cycle to load the new firmware into the hardware.

Genlock and Your System

For video stability and proper system operation, it's always best to genlock all equipment to house sync. Although genlock is not absolutely required for KONA LHe Plus or your system, better quality and repeatable operation will be experienced by doing so. Usually, this means using a black burst generator output looped through the system. On the KONA LHe cables and optional KL-box breakout box, house sync is connected to "Ref Loop".

Chapter 3: Operation

Using KONA LHe Plus with Professional Video /Audio Software

After you install the KONA LHe Plus software and any AJA plug-ins to support your choice of 3rd-party software, you're then ready to begin capturing and playing back video and audio.

Go here to look for AJA plug-ins and documentation for your favorite 3rd-party software applications:

<http://www.aja.com/en/support/downloads/>

Once you've installed all the AJA software as detailed in Chapter 2, you'll find the AJA Control Panel application installed on your computer.

Using The AJA Control Panel

The AJA Control Panel is a software application that provides a simple visual way to see how the KONA LHe Plus card is currently configured and then make changes as desired. Settings—both what you changed and didn't—can be saved as a snapshot for recall at anytime. This lets you save settings associated with all your frequent tasks; then as you switch tasks you don't have to spend extra time constantly resetting card configurations—just load the previously saved settings for each task.

One thing you'll notice instantly about the Control Panel is that it represents a visual block diagram of how the card is set. The current status, input and output settings, up/down/cross-conversion, and many other details can be viewed as a color-coded block diagram in the Control Panel.

Control Panel Basics

Although the KONA LHe Plus card auto-configures depending on the inputs present, and the Control Panel intuitively shows at a glance much about what the card is doing, there is even more information presented that may not be obvious. To ensure you make the most of the software, run the AJA Control Panel application and look at its display. Then refer to the "Basics" described here to fully understand what you're seeing and learn how to view and change the KONA LHe Plus system configuration.

Note: The KONA Control Panel also works with other KONA cards, Io HD and Io Express. However, the actual features and screens displayed differ slightly since the board feature sets differ.

Before we go into too much detail, here are some basic definitions you should know (please refer to the figure that follows for reference). After studying the basics, read “*Who is Controlling KONA?*” later in this chapter for more advanced information on how applications interact with the KONA LHe Plus board.

Control Panel Screens—the bottom area of the AJA Control Panel provides different information categorized by topic. Clicking on one of the Screen links from the left navigation column will result in an information screen corresponding to that screen’s topic. Each of the Control Panel screens are described on the following pages.

Screens available are:

Control: configures the default output (test pattern, pass through, desktop, etc.) plus setting genlock and output timing.

Format: select the framebuffer primary video format, any secondary formats, and parameters of conversion for input/output.

Input Select: view and edit input selections and how they are mapped.

SDI Output: assign outputs to either Primary or Secondary formats.

Analog Output: configure the component/composite +Y/C analog output.

Video Setup: configures Video options such as composite black level.

Audio Setup: configures analog audio monitor level and delay.

Conversion: used to select codec options such as whether paused video appears as a full frame or a single field (jitter shown or not shown) and 24 to 30 fps padding patterns.

DS Keyer: select downstream keyer mode, specify a graphic file or matte.

Timecode: monitor RP-188 timecode and configure timecode window burn output (**Note:** SMPTE 12M-2 is the updated name and specification for what was RP-188)

Presets: add or delete saved preset configurations (handy for setting up the KONA LHe for certain workflows and then saving it as a canned configuration for easy later recall)

Firmware: enables installation of AJA card firmware.

Info: displays status information about the KONA. This information is generally intended for troubleshooting and support.

Block Diagram Screen—the top area of the AJA Control Panel shows a visual picture representing the processing (if any) that’s currently occurring, including inputs/outputs, any down-conversion, reference source, and system status. Lines between inputs, the framebuffer, and outputs, show a video path. Where there are no lines, it shows there is no connection; this can be either because an input or output isn’t selected or because no video is present at the selected input.

Icon objects on the block diagram screen (input/output icons, frame buffer, etc.-also called “widgets”-indicate their status by color (explained later) and when clicked will bring up the proper Control Panel screen used to configure that item. For example, clicking on an SDI output icon will cause the “SDI Output” screen to be displayed below the block diagram. With the mouse on a block diagram element, you can also control click to reveal contextual drop down menus for certain functions.

Text Color—Colored text in the block diagram provides an indication of signal type and what the KONA LHe Plus is doing. Text in blue shows the values automatically selected, while text in black shows values that have been manually selected. Text in red shows that the KONA is not detecting a signal or cannot negotiate with the attached device (even if it can’t detect an output device, it still shows the signal it is outputting).

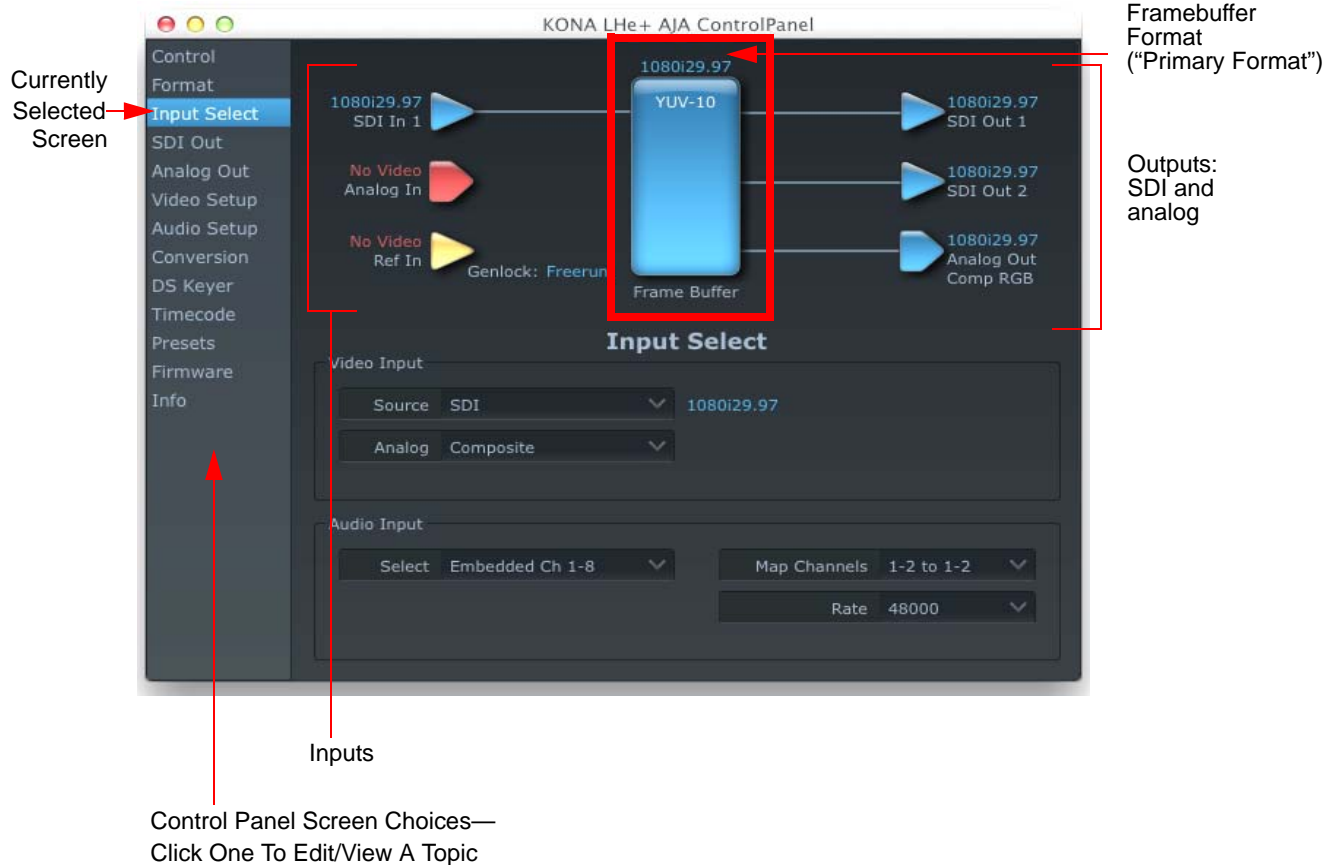

AJA Control Panel, Block Diagram

Framebuffer—the framebuffer is the “engine” in the KONA LHe Plus where active video operations take place using 3rd-party applications, or even the KONA itself. The framebuffer has a format (called the “Primary Format” and color space that it follows, as defined in the Control Panel or via external third-party application software).

It is important to realize that inside the computer, many applications can use the KONA LHe Plus (as you switch from window to window) and it may not always be obvious which is currently controlling it. The AJA Control Panel displays the name of the application controlling the card in red text at the top right of the Control Panel Screen. See [“Who is Controlling KONA?” on page 53](#). If an application does not properly “let go” of the KONA as another takes over—you’ll be able to tell by looking at the Control Panel.

Primary (Framebuffer) Format—the video format currently assigned to KONA LHe Plus. This is the format that the framebuffer will use and is shown in the Control Panel using the color blue. All icons in blue are the same as the Primary Format used by the framebuffer. Also any text descriptions in the block diagram that appear in blue also indicate that something is in the primary format. So, for example, if you see that the input and output icons are blue, then you know that the same format is used throughout the video path and that no format conversion is being performed. If a different color is displayed on the input or output, green for example, then you know that the KONA LHe Plus is performing a format conversion in the video path.

Secondary Format—any format other than the currently selected Primary Format, is a secondary format. As described previously, this means that either the Inputs or Outputs are somehow different from the framebuffer’s assigned format (i.e., the “Primary Format”). This can be seen at a glance because the color will be different than blue.

Input/Output Icons—the input and output icons are triangles that together with their color show all the input and outputs and their status (selected, not selected, input present or not, format, etc.). A complete video path is shown when inputs and outputs are connected with lines going to/from the framebuffer.



Input/Output Icon

Conversion Icon—when an input or output is a different standard than the framebuffer then the KONA LHe Plus may be down-converting the signal to the proper standard. This may be automatic, because it's detected an input signal that differs from the standard currently selected, or because you've explicitly told it to convert. In either case, the block diagram will show the conversion by displaying a conversion icon in between the input/output and the framebuffer.



Down Conversion Icon

If you click on a conversion icon, the Screen will change to the Format screen, allowing you to view/edit settings.

Color Meanings—all items in the AJA Control Panel block diagram are color-coded to show what is happening in realtime. This applies to both icons and text. These colors have the following corresponding meanings:

Blue: video is same format as the Primary Format (framebuffer)

Red: there is no video, the selected operation cannot be performed, or an invalid selection has been made

Yellow: reference video (black burst or other reference source)

Green: indicates that LHe Plus is performing some kind of active change to the video, to make it different from the Primary Format (e.g., down convert).

Control Screen

The KONA LHe Plus can be controlled by various software applications running on a host Mac and can be used as a Macintosh Desktop extension. The Control Screen is where you select how the card directs video and is used by application software. This screen also provides control for configuring output/playback timing with regard to external reference video and horizontal/vertical delay.

At the top of the Control Default Output pane, it will show the current Default Output and above the block diagram (right side) the application currently controlling it (if there is one). For example, in the screen shown here, the default output is a Test Pattern.

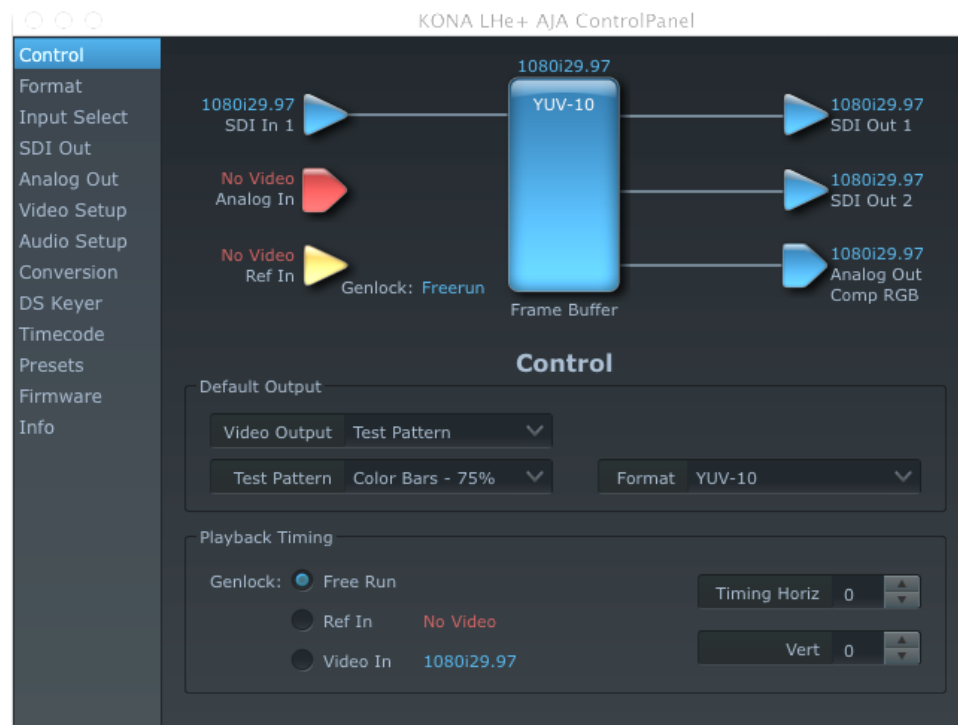

AJA Control Panel, Control Screen

Control Screen Settings

Default Video Output—this is where you select what the KONA LHe Plus will output as a default when no application has control of it, such as when the Finder is active. Since it can be controlled by software applications as well as its own control panel, the output can change dynamically. Some video applications will grab control of the KONA LHe Plus inputs/outputs. These settings determine what happens when an application is active that *does not* grab the KONA LHe Plus inputs/outputs.

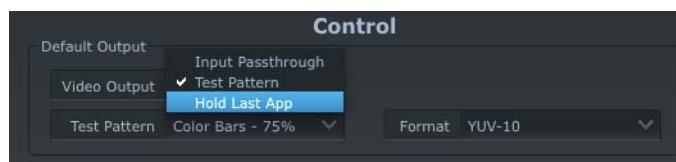

AJA Control Panel, Control Screen, Default Output Pulldown Menu

Default Output Choices and their meanings:

Input Passthrough: this selection directs KONA LHe Plus to route video from its selected input through the card for processing and output. When this selection is in effect, all Primary/Secondary Format selections are available for selection in controlling the output. This in effect makes the LHe Plus a converter when used in conjunction with the AJA Control Panel application and a Mac.

No applications other than the AJA Control Panel need to be open to convert audio and video from one format to another. For example, if an SD source tape needs to be dubbed to an HD tape, the signal might be routed from the SD VTR to the LHe Plus, configured for up-conversion in the Control Panel and then passed through to the HD VTR for recording.

Test Pattern: this selection directs KONA LHe Plus to output a choice of preset pattern when no other application is using the card. In addition to the provided test pattern choices, a "Load File..." selection at the bottom of the menu allows you to load any standard Mac RGB graphics file (.tif, .psd, etc.) into the frame buffer for display.

Note: The graphic file will not be scaled to fit. If it's smaller than the current frame buffer format, KONA LHe Plus will center it in the frame. If it's larger than the current frame buffer format, it will be cropped on the right and bottom. Also some graphics formats and bit depths may not be supported. Once a graphic file is loaded into the frame buffer it will be retained until it is overwritten by another graphic or test pattern, or when power is turned off. Graphic file names are only "remembered" in the menu as long as the AJA Control Panel application is running.

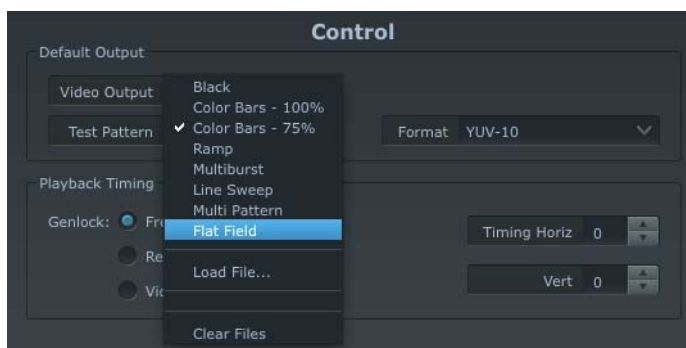

AJA Control Panel, Test Pattern Choices

Warning: *Format:* When Test Pattern is selected, the color Format menu is active and allows you to select either 10-bit YUV or 10-bit RGB for the default output color format.

Hold Last Application: this selection directs LHe Plus to hold and output the last frame of video from the last application to control LHe Plus. This can be helpful when operating in an environment where you're switching back and forth between multiple application windows.

Tip: pressing and holding the Apple COMMAND key while clicking in the AJA Control Panel—while in any software application (Final Cut, etc.)—causes control of the KONA to stay with that application, rather than shifting to the Control Panel. This works regardless of the setting of "Default Output."

Genlock (Freerun, Ref In, Video In)—selects how KONA LHe Plus will synchronize program video:

Freerun: In this mode, KONA LHe Plus generates sync without an external reference source

Ref In: Directs KONA LHe Plus to use the Ref Video source for sync (usually an analog black burst video signal)

Video In: Directs KONA LHe Plus to use whichever video input source has been selected in the Inputs Screen for sync.

Timing (Horiz and Vert)—these two pull-downs allow output timing adjustment with reference to the Ref Video source selected. The Horizontal reference can be adjusted by selecting a number of pixels (clocks) to offset. Vertical can be adjusted by specifying a number of lines to offset.

Formats Screen

The Formats screen shows the video format currently in use by the KONA LHe Plus framebuffer (called the *Primary Format*) and allows you to change it. All throughout the Control Panel, choices are always presented based on what KONA LHe Plus can do with the signals available and the inputs/outputs selected. For example, on the Formats screen, if the output or inputs are a different format than the primary, then you'll see an additional information pane that allows you to view and edit the secondary format—including control over whether down conversion is employed.

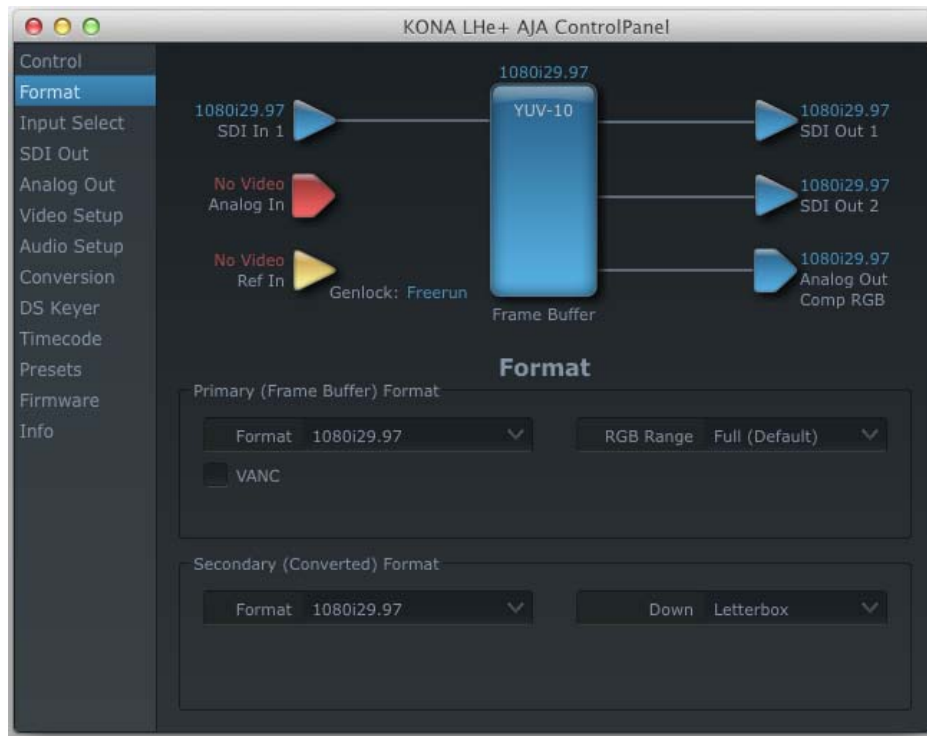

AJA Control Panel, Formats Screen

For a complete list of Video Formats supported by KONA LHe Plus, see [“Video Formats” on page 59](#).

Format Screen Settings

Primary (Framebuffer) Format—this pull-down menu shows the currently selected format. This pull-down appears in both the Primary Format area of the Formats screen as well as the Secondary Format area (if present). If you select an alternate value in the Primary Format using the pull-down, it will change the format used by the KONA LHe Plus framebuffer. When a change is made via the Video Format pull-down or by clicking an icon (widget) and selecting a new format via a contextual menu, the block diagram will change to reflect the new format.

VANC—enables or disables VANC data capture and playback.

Secondary (Converted) Format—the formats available can vary based on what the Primary Format is and the input signal (frame rates of input sources limits the to/from conversion choices). The “Secondary Video Format” pull-down menu lists all compatible formats in black (incompatible formats are shown in gray and cannot be selected). This allows you to see what you've chosen, and also see those formats that are compatible with the selected Primary format.

Note: The AJA Control Panel software uses the abbreviation “sf” instead of “Psf” when referring to “progressive segmented frame” formats. In the manual and in other literature you may see either of these acronyms used interchangeably. Visually it is easier to discern at a glance if you are working with progressively segmented frame formats (sf in the AJA Control Panel) as compared to progressive frame formats which will show only “p.”

Down (Conversion)—for down-conversion the following choices are available:

Anamorphic: full-screen “stretched” image

Letterbox: image is reduced with black top and bottom added to image area with the aspect ratio preserved

Crop: image is cropped to fit new screen size

Input Select Screen



AJA Control Panel, Input Select Screen

On the Inputs screen you can view the currently selected video and audio input sources and map audio sources to the channels supported by your third-party editing application (more on this later). Two information panes in the screen are provided: Video Input and Audio Input.

Input Screen Settings

Video Input—These pulldown menus allow you to see and change what's currently selected for the video (SDI or Analog) and the audio input. If Analog is selected, then you also need to select the type of Analog input via a pulldown menu. Choices are:

- Composite
- Y/C
- Component (SMPTE/EBU N10)
- Component (Beta)

Audio Input—This pulldown menu allows you to pick where the audio comes from. KONA LHe Plus supports up to 8 channels of embedded digital audio, so you can choose out of the 16 channels that can be embedded in SDI, and pick which to bring in (from the group 1-8 or 9-16). If your editing application supports two channels of audio, here you can also select which two channels from the 8 embedded will be mapped to the application's two channels.

SDI Output Screen

The SDI Out screen shows the current settings for the two SDI outputs. If an input/output has no video, it will be indicated on the block diagram (“No Video”).

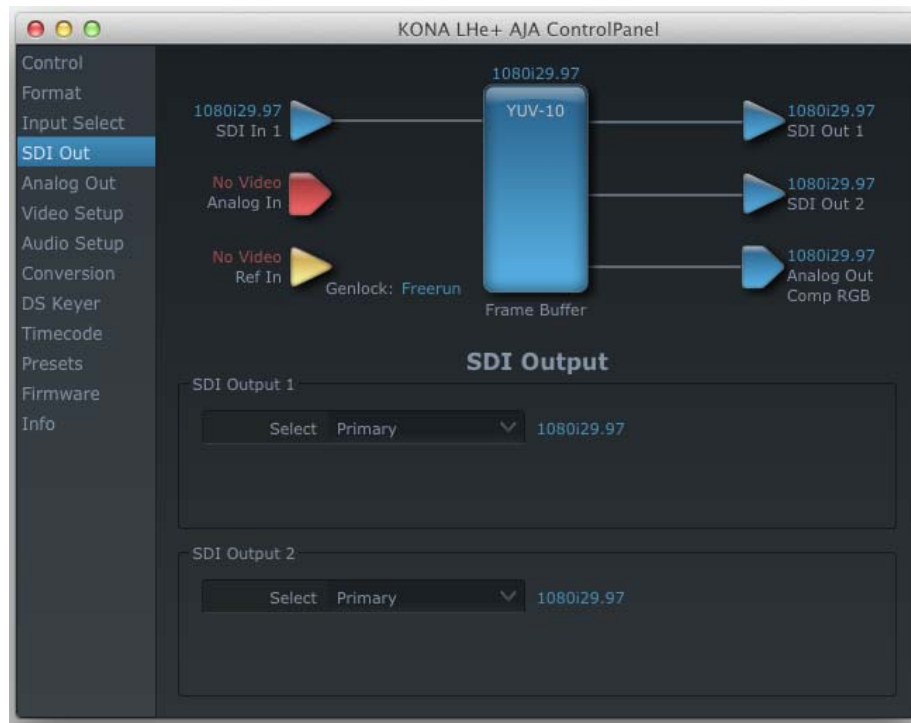

AJA Control Panel, SDI Out Screen

SDI Output Screen Settings

Information that can appear includes the following items. You can view the current setting or use a pulldown menu to select:

- Primary**—when selected, this indicates that an SDI output (SDI Output 1 or SDI Output 2) is set to the same format as the framebuffer. That value will be listed in blue.
- Secondary**—when selected, this indicates that the SDI output is set to a format different from the framebuffer (Primary Format). That secondary format value will be listed in green. This shows that active processing of the video is taking place (format change and possibly down-conversion).

Video+Key—when selected, this selects that both SDI outputs will be used for a Video plus an associated video Key (hole cut). This will be reflected in the block diagram by showing the two lines grouped together going from the framebuffer to the SDI 1 and SDI 2 outputs. Selecting Video+Key on one pulldown also causes the other pulldown to change to Video+Key since the outputs are used as a pair.

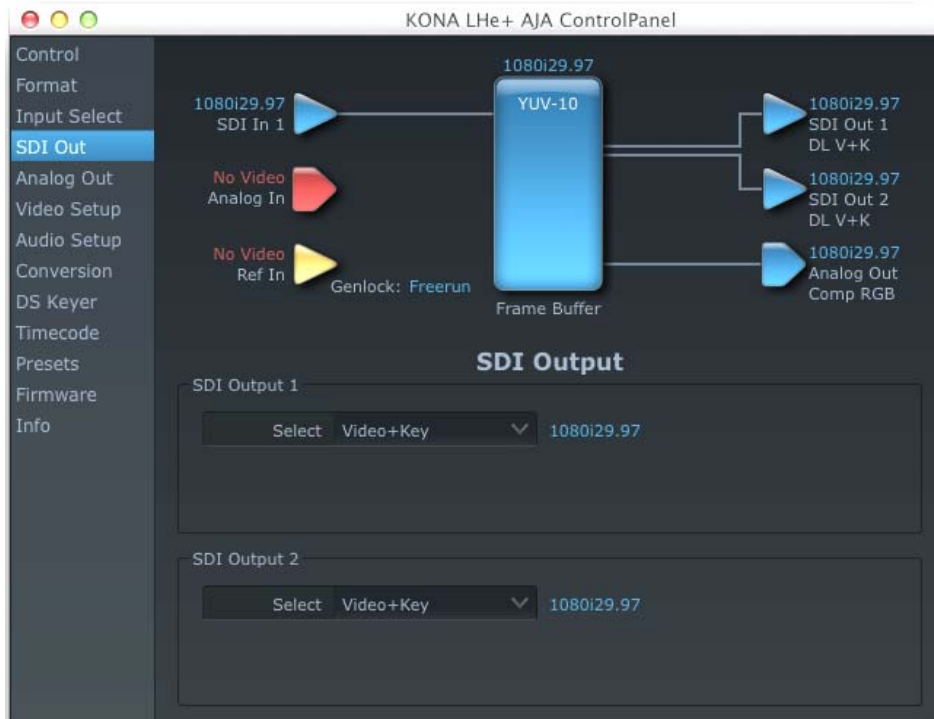

Analog Out Screen

KONA LHe Plus provides a high-quality analog component or composite output, generally used for monitoring. This screen shows the current settings for that analog output, and allows you to re-configure it when desired.



AJA Control Panel, Analog Out Screen

Analog Out Screen Settings

Select—Primary or Secondary (conversion)

Analog Format—choices in the Analog Format pulldown menu vary depending upon the Analog Output video standard. For example, the “Composite + Y/C” selection is only available when an SD (525i29.97 or 625i25) format is in use. Analog formats can include:

- Composite +Y/C
- Component (SMPTE/EBU N10)
- Component (Beta)
- Component (RGB)
- Component (RGB -HV)

Monitor Audio—select which two channels will be routed to the stereo pair of unbalanced consumer audio outputs on the KL-Box (option).

Video Setup Screen

The KONA LHe Plus Analog Black level and QuickTime Video Output Display Filter are configured here.

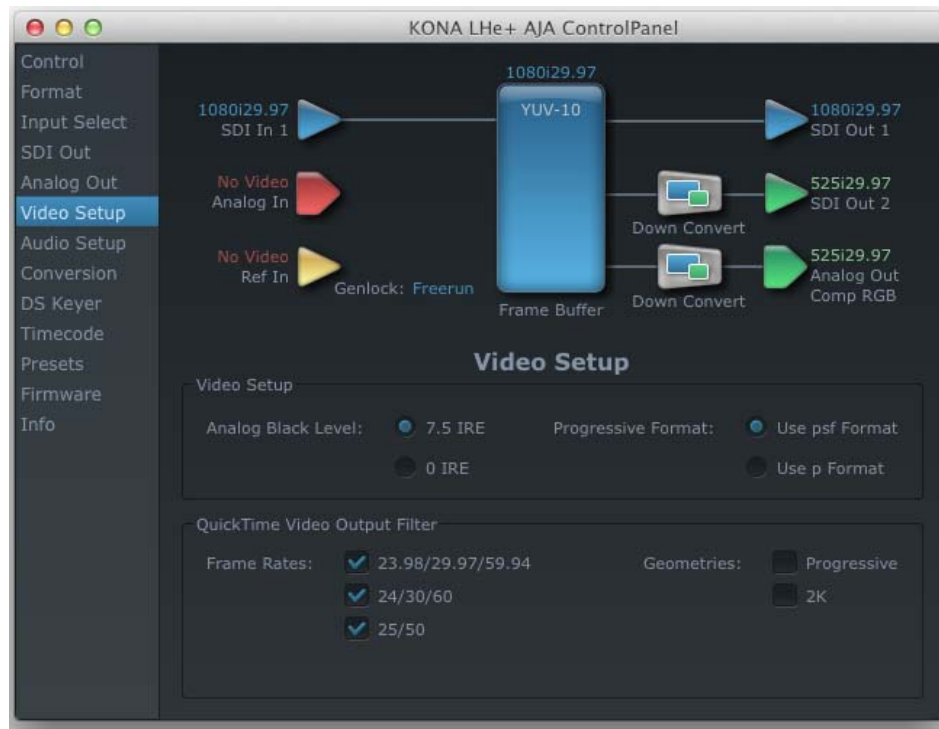

AJA Control Panel, Video Setup Screen

Setup Screen Settings

Analog Black Level—choices in the black Level pulldown menu are only available for the two Composite analog formats. Choices presented are for US or Japan settings:
 7.5 IRE (NTSC US)
 0 IRE (NTSC Japan)

QuickTime Video Output Display Filter—these controls help manage the comprehensive list of video outputs and geometries that may be available to applications.

By selecting the checkbox next to specified parameters, the video outputs related to these specified parameters are enabled as possible video outputs for applications. To avoid confusion when working in a particular editorial environment, users might elect to leave 50Hz unchecked if they work solely in a 60Hz editorial environment.

Audio Setup Screen

The KONA LHe Plus audio settings are configured here.



AJA Control Panel, Audio Setup Screen

Audio Setup Screen Settings

Lock Audio Gain To Unity—When set, the KONA card will ignore third-party application gain setting and set the audio gain at unity. When not set, this checkbox tells the KONA card to get the audio gain setting from the application.

Analog Audio Monitor Level—when a KL-Box is connected to KONA LHe Plus, the button selected determines the audio level that will appear at the Analog Audio Output RCA connector pair (“FSD” is *full-scale-deflection* reading as measured on a VU meter). Select +18 for Europe or +24 for USA.

Conversion Screen

The Conversion screen is used to set frame, field, and color space conversion options.



AJA Control Panel, Conversion Screen

Conversion Screen Settings

Pause On—these two choices determine what happens when an editing application is paused in stop mode:

Full Frame: both fields are displayed resulting in some jitter while paused.

Single Field: a single field is displayed, showing no flicker (useful when color correcting or whenever the flickering would be a distraction).

3-2 Pulldown Pattern—after format selection, the value selected in this menu is used whenever you've chosen to do conversion from 24 frames-per-second to 30 where extra fields are added to pad existing ones. Depending on video content, selection of different field patterns may be useful in reducing jitter due to the content of adjacent fields. The numbers in the pattern choices specify the frequency with which inserted fields will be repeated. For example, "2:3:2:3" means that the conversion will duplicate a field twice, then the next field three times, then the next twice, and then back to three times.

3-2 Pulldown Offset—select a frame offset value from 0 to 4.

RGB-YUV Conversion: These pulldowns select industry standard color space and gamma transfer functions for the YUV-RGB conversion, or allow you to direct the KONA card to automatically determine it for you.

Colorspace—choose from:

Rec 601 – for SD

Rec 709 – for HD

Auto

Gamma—choose from the following:

Linear (1.8)

Rec 601 (2.20)

Rec 709 (2.22)

Auto

Enable Custom LUTs—this checkbox enables a custom color lookup table (LUT)

DS Keyer Screen

The KONA LHe Plus has a hardware-based downstream keyer that is ideal for putting logos, “bugs” or other video material with an alpha channel on top of video being played out or printed to tape. A typical application would be putting a television station's call letters or channel over program video content. Keyed video can be from the KONA's internal Frame Buffer (from storage, video In, KONA TV, etc.) or from a graphics file that has an alpha channel (PhotoShop etc.).



AJA Control Panel, DS Keyer Screen

DS Keyer Settings

Downstream Keyer Mode:

Downstream Keyer Off — when this pulldown menu item is selected the downstream keyer will be turned off

Frame Buffer over Matte — places the keyed video with alpha channel currently in the Frame Buffer over a fixed color matte determined by the “Matte Color” setting set separately.

Frame Buffer over Video In — places the keyed video currently in the Frame Buffer over the video input for playout or print-to-tape.

Matte Color: only available when the pulldown “Frame Buffer over Matte” or “Graphic over Matte” are selected—pressing this button brings up a color selection dialog. The dialog provides a variety of ways to select a matte color including a color wheel, color picker (choose from a location anywhere on the computer screen), numeric sliders, swatches, “crayons”, and spectrums. The matte chosen will be used as a video background under the keyed video.

Foreground pre-multiplied (checkbox): use to avoid “matte lines” and improve the appearance of the foreground (key) being composited over the background.

Audio Out:

Frame Buffer — select audio out to be routed from the contents of the Frame Buffer.

Audio In — select audio out to be routed from KONA’s currently selected input(s).

Timecode Screen

The timecode is used for both monitoring the RP-188 timecode embedded in the digital data stream and for selecting a timecode offset (if required) for the attached VTR (connected to the KONA LHe Plus RS-422 port)—and sent during assemble-edit mode.

Note: SMPTE 12M-2 is the updated name and specification for what was RP-188.



AJA Control Panel, Timecode Screen

Timecode Screen Settings

RP-188 Timecode <n>—in RP-188 timecode (SMPTE 12M-2) there can be multiple timecode values in the data stream. Use this pull-down to select the one you wish to monitor. The selection will be displayed in the timecode value displayed to the right of the pull-down.

User Bits—For monitoring variable framerate (VFR) timecode (such as Varicam), you may wish to monitor the user bits embedded in the timecode. If you set this checkbox, KONA LHe Plus will detect and interpret the user bits and display them next to the checkbox.

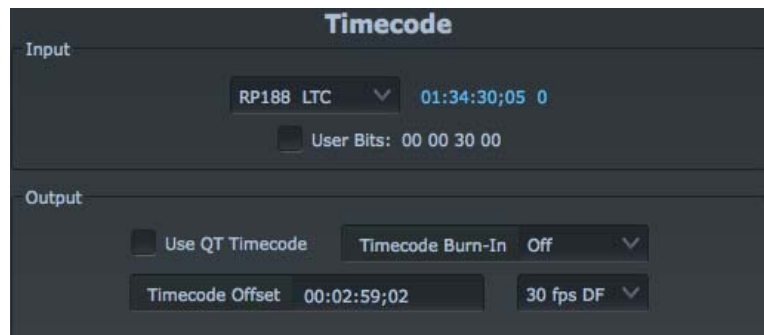

AJA Control Panel, Timecode Screen, User Bits Checked

Use QuickTime Timecode—when checked, this directs KONA to output timecode from the QuickTime timecode track. When not checked, KONA uses the *Output Timecode Offset* value plus the number of frames into the movie. Note: not all QuickTime applications use or support timecode tracks—so sometimes the QuickTime timecode is missing or not meaningful.

Output Timecode Offset (entry field and FPS pull-down)—this text entry field allows you to specify a timecode offset for use with your editing application if it has timecode offsets that are user-controlled. In FCP 7, go to “Timeline Options” and locate the “Starting Timecode” value. Use that same value here as the “Output Timecode Offset” to ensure the timecode is synchronized.

Timecode Burn-in—this pulldown selects whether the timecode value is “burned-in” on video output from KONA LHe Plus. If set to “OFF”, timecode will not be keyed over the video. If set to “timecode”, then the timecode value will be keyed over the output video. This can be useful for synchronizing, choosing edit points, dailies, and many other purposes.

Note: SMPTE RP 188 defines a standard for the transmission of time code and control code in the ancillary data space of a digital television data stream. Time code information is transmitted in the ancillary data space as defined in ANSI/SMPTE 291M. Multiple codes can be transmitted within a single digital video data stream. Other time information, such as real time clock, DTTR tape timer information, and other user-defined information, may also be carried in the ancillary time code packet instead of time code. The actual information transmitted through the interface is identified by the coding of a distributed binary bit. Equipment manufacturers can use the meta data for different purposes.

Presets Screen

After configuring the AJA Control Panel screens, you can then save all your settings as a snapshot for later recall—called a *preset*. In this way, you can organize presets for all your typical tasks, eliminating time-robbing manual reconfiguration each time. To save a preset, go to the Presets screen and click “Save Preset”. A dialog will be presented asking you for a name; enter a meaningful name and click “OK”. Thereafter the preset will be available under the Control Panel “Presets” list.



Presets Screen

From the Presets screen you can manage your collection of presets easily. To Load or Delete a stored preset, just select it with your mouse and then click the “Load Preset” or “Delete” button respectively.

Firmware Screen

Use the Firmware Screen to access the firmware install screen. Click install to erase current firmware and load the firmware version contained in your current driver installation. Note the Installation message shown below.

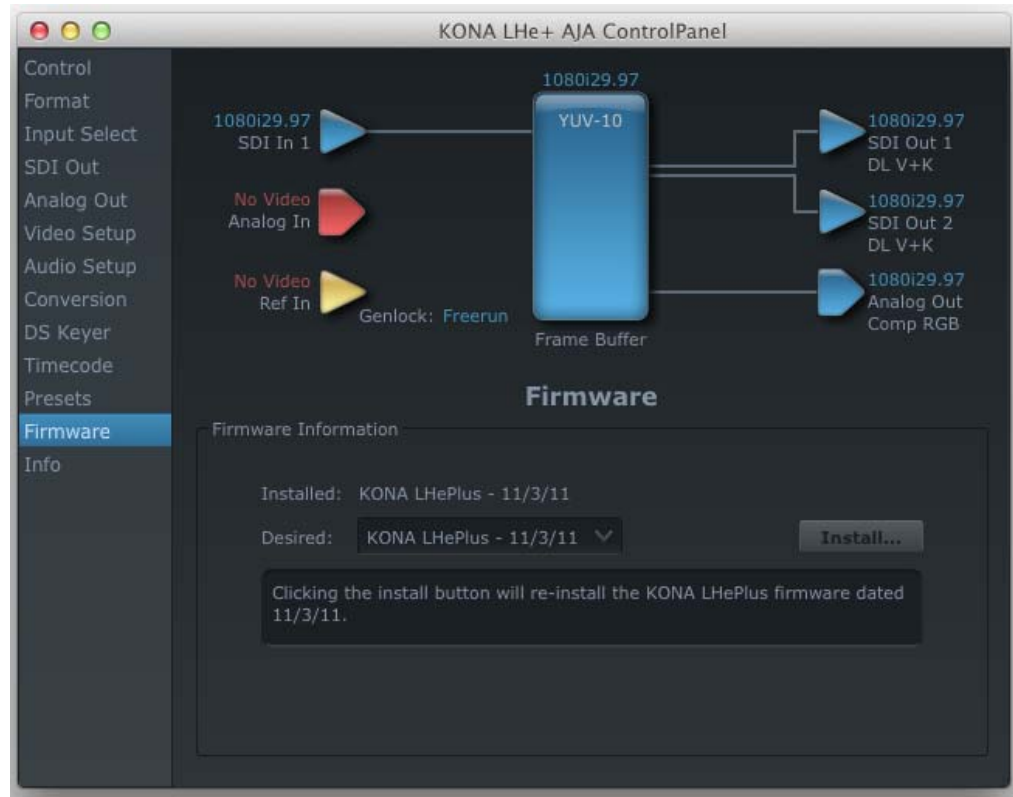

Firmware Update

You will be required to power-cycle your computer to finish the update.



Update Completed

Info Screen

The Information screen shows the KONA LHe Plus software files that have been installed on your system. This information may be needed if you talk to an AJA Customer Service representative to determine if files are missing or need updating.

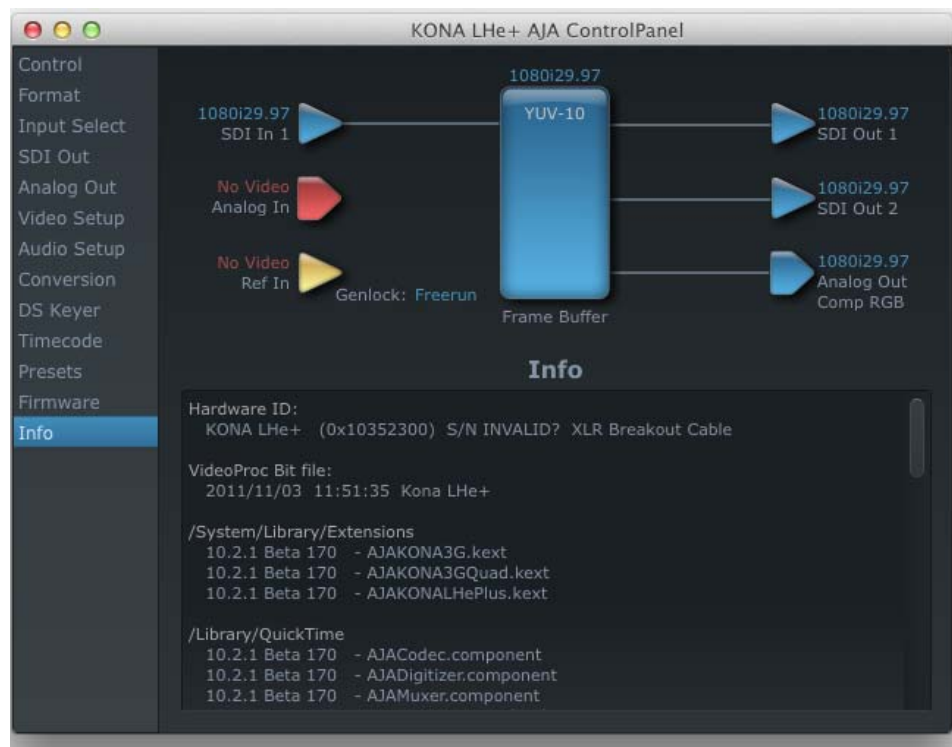

AJA Control Panel, Info Screen

Who is Controlling KONA?

There are times when you might have several Quicktime applications open at one time, and each of these might want to output their video thru the KONA video output. KONA is very flexible and most applications perform the necessary housekeeping so they work correctly when they're active and when they're not. This means that the application that is "active" (in front) will be granted control of the KONA video output. Generally, when you switch to a different application, the previous application lets go of the video output and the new application gets control.

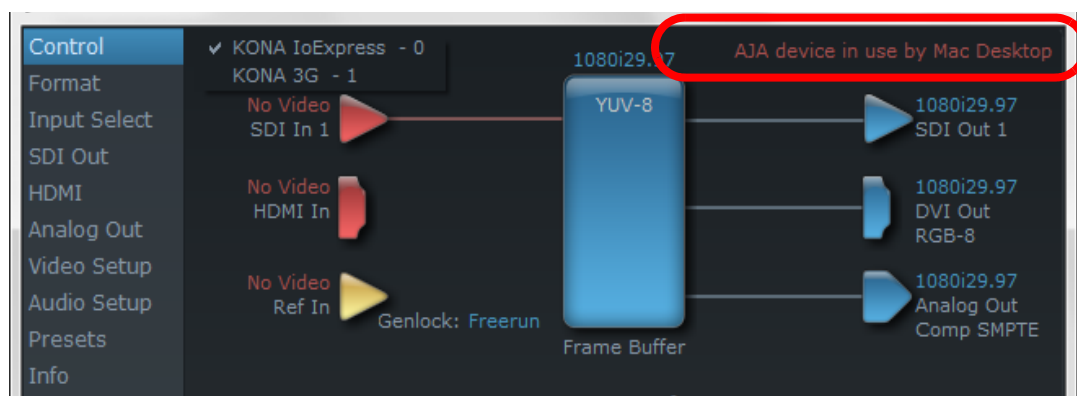

KONA/AJA Control Panel Control Message

The AJA Control Panel in-use message will tell you the "active" application that has control of KONA (see in-use message above) and what the format selections are. If you click on another

supported application that is running such as Adobe Premiere Pro or AJA TV, the AJA Control Panel in-use message will report the change by displaying the new application in control. If no in-use message is displayed, the AJA Control Panel is in control of KONA. If no QuickTime applications are running, the board's state is determined by the AJA Control Panel application's settings.

QuickTime Application Format Selection

If a running QuickTime application uses KONA for capture or output, it controls the Primary format via its own menus and settings. For example, when the editing application is active (it's the front-most application) and has KONA as its "A/V Device", then the KONA's Primary format is determined by the application's Video Playback submenu (under the "View" menu) or its "Audio/Video Settings..." dialog under A/V Devices. These format selections are reported in the AJA Control Panel block diagram.

QuickTime applications can start and stop and change modes—even while they are running. And the behavior of different QuickTime applications can vary: some applications take control of the interface as soon as they are launched and don't give it up until they quit, while other applications take control of the interface only when they are the "front-most" running application and then relinquish control when they're not. Even these QuickTime applications may not relinquish control until capture or output operations are completed.

Control Recommendations

We recommend you have the Control Panel running and visible at all times. When the Control Panel is running in the background (not front-most) you can see what the interface is doing and who has control of it.

Using Multiple AJA Products

Starting with the v7.5 drivers, more than one AJA product can be used with your host computer. Using the AJA Control Panel application, you can choose which installed product an application uses for input/output. In the upper left corner of the AJA Control Panel application, you will see a board name, such as KONA 3G - 0, if you have more than one product and the associated drivers installed (if only one product is installed, you'll see no product or pulldown). To “target” a specific installed product for use, click on the text in the upper left hand side of the UI and select from the list of available products that appear in the pulldown.



When you launch a third-party application or AJA TV, that application will use the product that is currently selected in the AJA Control Panel application for its input/output. Once an application is running, you can change the “targeted” product selection in the AJA Control Panel and select a different product. The running application will retain its connection to the product. If you change the “targeted” product and launch a different application, that application will use the new product for its input/output, while the first application you launched will continue to use the other AJA product.

Example: select a KONA 3G as the targeted product in the AJA Control Panel application.

Launch your third-party editing application. The application is now using the KONA 3G for its input/output. Go back to the AJA Control Panel application and select a KONA LHe Plus as the “targeted” product. Launch the AJA TV application. AJA TV would now use the LHe Plus for its output. If you switch back to the third-party application, you would note that it is still uses the KONA 3G for its input/output. Note that some applications, like AJA TV, have a provision for playing in the background, so playback on one product could even continue when switching the targeted device for use with another application. You can even feed the output from one AJA product to another AJA product on the same system in such cases.

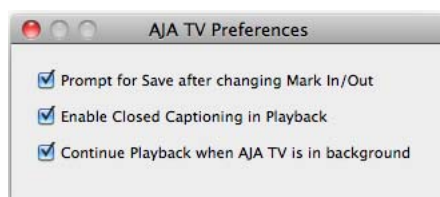

AJA TV Preferences, Continue Playback when AJA TV is in background

AJA TV optionally supports playback in the background; checkbox “Continue Playback when AJA TV is in background.”

Notes on using multiple AJA Products:

Performance of multi-product use depends on a variety of factors: CPU usage, RAM, disk IOPS/bandwidth for streams of video, etc. and therefore performance may vary. Also be aware that multiple input/output streams are only supported by software that is explicitly designed for a multi-product environment.

Using 8-bit Versus 10-bit Video

While both 8- and 10-bit uncompressed video are capable of providing excellent quality broadcast video, 10-bit represents a significantly higher quality and is preferable in many situations.

Because 10-bit video has four times the numerical precision when compared to 8-bit, it has a signal-to-noise ratio 12 db higher than 8-bit video.

Visually, in 8-bit video compared to 10-bit video, you will notice a substantial difference. In 8-bit video there will be “contour lines” or “striations” visible, particularly noticeable in scenes having soft gradients like a ramp or sunset. For example, if a sky region is mostly the same color but varies by only a few digital numbers from one side of the picture to another, you may see contour lines where the signal passes from one digital value to the next higher value.

Since each numerical value in a 10-bit system is only one fourth as large as an 8-bit system's, these contours become invisible and the sky varies smoothly.

10-bit video is often used when the source and output video (or “master”) is also 10-bit. Even if the input and/or output video is 8-bit, a 10-bit “project” will still maintain a higher quality when there is a significant amount of effects rendering involved.

Industry standard professional mastering formats—Sony Digital Betacam for Standard Definition and Panasonic D5 for High Definition—are both true 10-bit formats.

Chapter 4: Troubleshooting

If You Run Into Problems

One useful way to find the source of problems is to isolate your system to the smallest size where the problem still occurs and then note all the symptoms. This serves to eliminate areas not involved in the problem and makes finding the problem easier.

Once you've noted problem symptoms, look through the following table and see if any of the symptoms are listed. If so, check the items listed. If you later need to call for customer service, let them know all of the things you've tried and when and how the symptoms appeared.

| Symptom | Check |
|---|--|
| Disk RAID cannot keep up (dropped frames etc.). | Ensure the disk system is providing at least 50 MB/second sustained transfer rate |
| Dropped frames during playback. | 1. Virus checking software running in the background (disable it). 2. Scratch drive not set to the RAID. |
| Dropped frames during record. | 1. RAID cannot sustain the data rate of the capture preset codec. 2. Virus checking software running in the background (disable it). 3. Scratch drive not set to the RAID. |
| Media is not being captured from desired external device. | Check the settings in the <i>Input</i> tab of the Io XT Control Panel application. Also check equipment cables. |
| Dropped frames during playback | Look for scroll bars in the viewer or canvas as a warning sign that the zoom setting exceeds the fit-t-window. |
| Video stutter during playback. | RAID cannot sustain data rate. |
| Render bar occurs when placing a clip on a sequence. | The sequence setting does not match the clip setting. |

Updating Software

Check on the AJA Video website for software updates:

<http://www.aja.com/en/support/kona/mac/kona-lhe-plus/>

If any are available, download the file and read any associated instructions prior to installing the software.

Support

When calling for support, first check over your system configuration and ensure everything is connected properly and that current presets and Easy Setups match what you are trying to do. Even if you cannot find the cause of the problem, having this information at hand will help when you call AJA Customer Support for help.

If the problem is unknown or you need general help, first contact the dealer where you purchased the product. AJA dealers offer product support for many service requirements.

If the problem is a Mac Pro system issue, or Xserve RAID issue, then call Apple Customer Support for help.

If the problem is an AJA Video KONA LHe issue, then contact AJA Video Customer Support, see "[Contacting Support](#)" on page ii.

Appendix A: Specifications

Video Formats

- 525i 29.97
- 625i 25
- 720P 50, 59.94, 60
- 1080i 25, 29.97, 30
- 1080PsF 23.98, 24, 25, 29.97, 30
- 1080p 23.98, 24, 25, 29.97, 30

Video Input Digital

- SD/HD SDI, SMPTE-259/292/296, 8- or 10-bits
- Single Link 4:2:2 (1 x BNC)

Video Input Analog

- Composite/S-Video (Y/C) (1 x BNC/2x BNC+adapter)
- NTSC, NTSCJ, PAL
- 12-bit A/D, 2x oversampling
- 3 line adaptive comb filter decoding
- +/- .25 dB to 5.0 MHz Y Frequency Response
- +/- .25 dB to 1 MHz C Frequency Response
- .5% 2T pulse response
- <1.5% Diff Phase
- <1.5% Diff Gain
- SD Component (3 x BNC)
- SMPTE/EBU N10, Betacam 525 line, Betacam 525J, RGB
- 12-bit A/D, 2x oversampling
- +/- .25 dB to 5.5 MHz Y Frequency Response
- +/- .25 dB to 2.5 MHz C Frequency Response
- .5% 2T pulse response
- <2 ns Y/C delay inequity

Video Output Digital

- SD SDI, SMPTE-259M, 10-bit
- HD SDI, SMPTE-292/296, 10-bit

Video Output Analog

- Composite/S-Video (Y/C) (1 x BNC/2x BNC+adapter)
- NTSC, NTSCJ, PAL
- 12-bit D/A, 8x oversampling
- +/- .2 dB to 5.0 MHz Y Frequency Response
- +/- .2 dB to 1 MHz C Frequency Response
- .5% 2T pulse response
- <1% Diff Phase
- <1% Diff Gain
- Component (3 x BNC)
- HD: YPbPr, RGB
- SD: YPbPr, RGB (component mode)
- SMPTE/EBU N10, Betacam 525 line, Betacam 525J, RGB
- 12-bit D/A, 8x oversampling
- +/- .2 dB to 5.5 MHz Y Frequency Response
- +/- .2 dB to 2.5 MHz C Frequency Response
- .5% 2T pulse response
- <1 ns Y/C delay inequity

Audio Input Digital

- 8-channel, 24-bit SMPTE-259 SDI embedded audio, 48kHz sample rate, Synchronous
- 2-channel, 24-bit AES/EBU audio, 48kHz or 96 KHz sample rate, Synchronous or Non-synchronous, Internal sample rate conversion (via 1 x XLR on breakout cable or optional KL-Box)

Audio Input Analog

- 2-channel, 24-bit A/D analog audio, 48kHz sample rate, balanced (via 2 x XLR on breakout cable or optional KL-Box)
- +24dbu Full Scale Digital
- +/- 0.2db 20 to 20kHz Frequency Response

Audio Output Digital

- 8-channel, 24-bit SMPTE-259 SDI embedded audio, 48kHz sample rate, Synchronous
- 2-channel, 24-bit AES/EBU audio, 48kHz or 96 KHz sample rate, Synchronous or Non-synchronous, Internal sample rate conversion (via 1 x XLR on breakout cable or optional KL-Box)

Audio Output Analog

- 2-channel, 24-bit D/A analog audio, 48kHz sample rate, balanced (via 2 x XLR on breakout cable or optional KL-Box)
- +24dbu Full Scale Digital (0dbFS)
- +/- 0.2db 20 to 20kHz Frequency Response
- 2-channel unbalanced output (via 2 x RCA jacks on optional KL-Box)

Down-Conversion

- Hardware 10-bit
- Anamorphic: full-screen
- Letterbox: image is reduced with black top and bottom added to image area with the aspect ratio preserved
- Crop: image is cropped to fit new screen size
- Reference Input
- Analog Color Black (1V) or Composite Sync (2 or 4V)
- Looping
- 75 ohm on optional KL-Box, terminated on supplied breakout cable

Machine Control

- RS-422, Sony 9-pin protocol (via breakout cable or optional K3G-Box)
- 9-pin D-connector pinout is as follows:

| | |
|---------------------|---------------|
| 1.....GND | 6.....GND |
| 2.....RX- | 7.....RX+ |
| 3.....TX+ | 8.....TX- |
| 4.....GND | 9.....GND |
| 5.....No Connection | Shell.....GND |

Index

Symbols

.pkg 20

Numerics

10-bit video 56
24 frames-per-second to 30 conversion 47
48kHz audio 2
8-bit Versus 10-bit Video 56
8-channel 24-bit 48kHz AES 2

A

AES audio 2
AES/EBU 18
AES/EBU Audio Inputs 9
AJA Utilitie 3
Analog 4 Channel Balanced/Unbalanced Audio 9
analog component 44
analog composite 44
Analog Format 44, 45
Analog monitor output 9
Analog Out Screen 44
Analog Out Screen Settings 44, 45, 46
Apple Expansion Slot Utility 11
Audio 2
Audio Input 41
audio input/output 17
Audio Inputs And Outputs 9
Audio Out 48

B

Balanced 9
Betacam 10
black burst 10
Black Level 45, 47
block diagram element 34
Block Diagram Screen 34
BNC Connectors 8
BNC connectors 8
Box Contents 12

C

Cable Connections 7, 17
Cable connector descriptions 9
cables 12
cables, what's included 12
Cabling the System 17
camcorders 9
Card Slots, recommended installation 14
CD-ROM 19
Chassis Connections 18

Codec Screen Settings 47
codecs 4
color matte 48
Color Meanings, Control Panel 36
color selection dialog 48
colors, meaning of 36
COMMAND key 38
Component Analog Video Out 18
Component settings 44
Component video 9
Component/Composite 9
composite output 44
Composite settings 44
Composite video 9
Configuration 19
Connector Descriptions 9
Connectors 8, 9
connectors 17
Control Panel Basics 33
Control Panel, KONA 2 33
Control Screen 37
Control Screen Settings 37
conversion icon 36
Conversion Icons, Control Panel 36
Crop 40
customer service 57

D

Data Rate Calculator 3
DB9 9, 18
Default Io HD Output 37
Digital Out Screen 42
Digital Out Screen Settings 42
Digital System 18
Down (Conversion) 40
downconversion 40
downstream keyer 48
DPXtoQTtranslator 3
drivers 19
DV (DV25) 4
DV50 4
DVCPRO HD 4
DVCPROHD 4, 5, 6

E

EBU N10 10
embedded audio 2

F

features 2
Foreground pre-multiplied (checkbox) 48

Format Screen Settings 39
 format, primary 10
 Frame Buffer over Matte 48
 Frame Buffer over Video In 48
 Framebuffer 35
 Freerun 38
 Full Frame 47

G

Gatekeeper 19
 Genlock 38
 Genlock and Your System 32
 Getting Help 58
 graphic file, test pattern output 38

H

Hardware 2
 HD editing 4
 Hold Last Application 38
 Horizontal reference 38
 house reference 10
 house reference sync 18
 house sync 32

I

Icons 36
 icons 34
 Icons, Control Panel 36
 Info Screen 53
 Input Pass through 37
 Input Screen 41
 Input Screen Settings 41
 Input/Output 36
 Installation Overview 11
 Installer Screen 20
 Installing Io Software 19
 Installing the KONA 2 Card 13
 Introduction, KONA 2 1
 IRE 45

K

K-Box connector descriptions 9
 K-Box, Front and Rear 8
 keyed video 48
 KONA 2 Software 19
 KONA 3 installation 11
 KONA TV 3

L

Letterbox 40
 Lock Input Audio Gain To Unity 46
 Log On Authenticate Prompt 20

M

Machine Control 9
 Manual 10
 Matte 48
 Matte Color 48
 menus, context-sensitive 34
 Monitor Audio 46
 Monitor Out 9
 Mountain Lion 19

O

offset, video adjustment (timing) 38
 OS X installer files 20
 Output Pulldown Menu 37

P

pattern, test 38
 Pause on 47
 PCI-Express slots 14
 PhotoJPEG 4
 Presets 51
 Primary 42
 Primary format 10
 problem symptoms 57
 Problems, what to do 57
 problems, what to do if you encounter 57
 progressive frame 39
 progressive segmented frame 39
 psf 39

Q

QTtoDPXtranslator 3

R

RCA connector pair, K-Box configuration 46
 rear panel 9
 Ref In 38
 Ref Loop 18
 Reference Video 10
 Requirements, System 6
 RGB 9
 RP 188 definition 50
 RP-188 49
 RP-188 Timecode 49
 RS422 9

S

Sample rate conversion 2
 SDI cables 18
 SDI embedded audio 2
 SDI Input and Outputs 9
 Secondary 42
 select audio 48
 set up 11

- shipping 12
- Single Field 47
- SMPTE protocol 9
- SMPTE RP 188 50
- snapshot, Control Panel settings 51
- Software 3
- Software CD 19
- software files that have been installed 53
- Software License Agreement Screen 21
- Software on a PowerMac G4 or Xserve Server 19
- software updates 58
- Sony 9
- Standard Cables 7
- Support 58
- support 58
- Symptoms, problem 57
- sync generator 10
- synchronizing other video equipment 10
- system configuration, Control Panel 33
- System Connections 18
- system interconnections 18
- System software 19

T

- Tabbed Windows 34
- Tabs available 34
- Tabs available, Control Panel 34
- Test Pattern 38
- Timecode Offset 50
- Timecode Screen 48, 49
- Timecode Screen Settings 48, 49
- timing adjustment 38
- Troubleshooting 57
- troubleshooting 57
- typical system interconnections 18
- Typical Workflows 4

U

- Uncompressed 10-bit 6
- Uncompressed 8-bit 6
- Unpacking 12
- Updating Software 58
- Use 52
- user and password 20
- User Bits, RP-188 49
- Using K-Box 8

V

- Vertical reference 38
- Video Format 39
- Video Input 41, 59
- video input source 38

- Video Monitor 18
- video path 35, 36
- Video/Audio connections 17
- video/audio I/O connections 17
- VTR 18
- VTR RS-422 Control Port 9
- VTR Xchange 3
- VTRs, 9

Y

- Y/R-Y/B-Y 9
- YPbPr 9
- YUV 9

