

KRAMER



USER MANUAL

MODEL:

TBUS-1-KWC

Table Connection Bus with Wireless Charging Spot



TBUS-1-KWC Quick Start Guide

This guide helps you install and use your product for the first time. For more detailed information, go to <http://www.kramerav.com/manual/TBUS-1-KWC> to download the latest manual or scan the QR code on the left.

Step 1: Check what's in the box

- ✓ The **TBUS-1-KWC** table connection bus with wireless charging spot
- ✓ 2 Table clamps
- ✓ 1 Power supply (5V DC)
- ✓ 1 Security bracket
- ✓ 2 Security springs
- ✓ 1 KWC-MUSB receiver
- ✓ 1 KWC-LTN receiver
- ✓ 1 Quick start guide
- ✓ 1 Cut out template

Step 2: Prepare the TBUS-1-KWC for mounting

Assemble the Inner Frame.

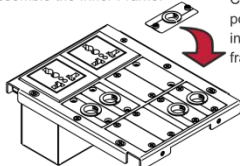

Carefully insert the power sockets and inserts to the inner frame.

Note that the power sockets and inserts are purchased separately.



Mount the Inner Frame into the **TBUS-1-KWC** enclosure.

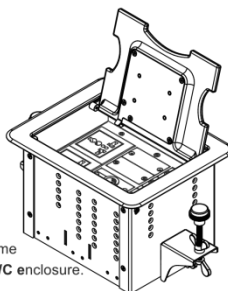

Adjust the height of the Inner Frame.

Step 3: Prepare the table for mounting

Cut out an opening in the table using the cut out template.



Step 4: Install the TBUS-1-KWC into the table

Insert the unit through the table opening and attach the power supply under the table using the power supply bracket.

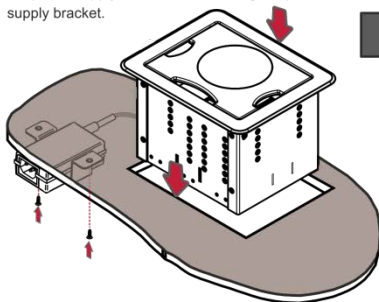

Note that you can attach one or more wireless receivers to the security bracket.



Secure the unit to the table.

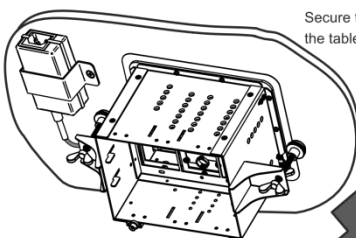

Connect the cables.

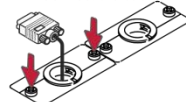

Contents

1	Introduction	1
2	Getting Started	2
2.1	Achieving the Best Performance	2
2.2	Recycling Kramer Products	3
3	Overview	4
4	Defining the TBUS-1-KWC	5
4.1	TBUS-1-KWC Optional Inner Frames	7
4.2	TBUS-1-KWC Optional Inserts	8
4.3	Power Socket Options	9
4.4	Power Cord Options	11
5	Installing the TBUS-1-KWC	12
5.1	Assembling the Inner Frame	12
5.2	Installing the Inner Frame	18
5.3	Cutting an Opening in the Table	18
5.4	Inserting the TBUS-1-KWC through the Cut Out Opening	19
5.5	Connecting the Cables	20
5.6	Inserting the Pass-through Cables	20
5.7	Adjusting the Height of the Inner Frame	21
6	Using the TBUS-1-KWC	22
6.1	Using the Wireless Charger	22
6.2	Using the Receivers	23
6.3	Using the Wireless Charger	24
6.4	Securing Wireless Charging Receivers	24
7	Technical Specifications of the TBUS-1-KWC	26
7.1	Technical Specifications of the KWC-MUSB and KWC-LTN	27

Figures

Figure 1:	TBUS-1-KWC inside a Table	4
Figure 2:	TBUS-1-KWC Table Connection Bus – Front View	5
Figure 3:	TBUS-1-KWC – Rear View	6
Figure 4:	TBUS-1-KWC Inner Frame (P/N: 80-000299)	13
Figure 5:	Installing a Kramer TOOL	14
Figure 6:	Installing the T-TBLANK TOOL Blank	15
Figure 7:	T-RC8IR (P/N: 80-000599)	16
Figure 8:	RC-8IR Faceplate Holes Table Connection Bus	17
Figure 9:	Cut Out Dimensions	18
Figure 10:	Inserting TBUS-1-KWC into the Prepared Opening	20
Figure 11:	Cable Pass-through Insert (P/N: 80-000499)	21
Figure 12:	TBUS-1-KWC Boardroom Installation	22
Figure 13:	KWC-MUSB Micro USB Receiver	23
Figure 14:	KWC-LTN Lightning Receiver	23
Figure 15:	Receiver Underside	23
Figure 16:	Connecting to the Security Bracket	24
Figure 17:	Threading the Loop through the Receiver Eyehole	25
Figure 18:	Security Spring with Bracket and Receiver	25

1 Introduction

Welcome to Kramer Electronics! Since 1981, Kramer Electronics has been providing a world of unique, creative, and affordable solutions to the vast range of problems that confront video, audio, presentation, and broadcasting professionals on a daily basis. In recent years, we have redesigned and upgraded most of our line, making the best even better!

Our 1,000-plus different models now appear in 14 groups that are clearly defined by function: GROUP 1: Distribution Amplifiers; GROUP 2: Switchers and Routers; GROUP 3: Control Systems; GROUP 4: Format/Standards Converters; GROUP 5: Range Extenders and Repeaters; GROUP 6: Specialty AV Products; GROUP 7: Scan Converters and Scalers; GROUP 8: Cables and Connectors; GROUP 9: Room Connectivity; GROUP 10: Accessories and Rack Adapters; GROUP 11: Sierra Video Products; GROUP 12: Digital Signage; GROUP 13: Audio; and GROUP 14: Collaboration.

Thank you for purchasing the Kramer **TBUS-1-KWC** Table Connection Bus featuring a charging spot, which is ideal for boardrooms, conference and training rooms!

2 Getting Started

We recommend that you:

- Unpack the equipment carefully and save the original box and packaging materials for possible future shipment.
- Review the contents of this user manual.



Go to www.kramerav.com/downloads/TBUS-1-KWC to check for up-to-date user manuals, application programs, and to check if firmware upgrades are available (where appropriate).

2.1 Achieving the Best Performance

To achieve the best performance:

- Use only good quality connection cables (we recommend Kramer high-performance, high-resolution cables) to avoid interference, deterioration in signal quality due to poor matching, and elevated noise levels (often associated with low quality cables).
- Do not secure the cables in tight bundles or roll the slack into tight coils.
- Avoid interference from neighboring electrical appliances that may adversely influence signal quality.
- Position your Kramer **TBUS-1-KWC** away from moisture, excessive sunlight and dust.



This equipment is to be used only inside a building. It may only be connected to other equipment that is installed inside a building.

Do not place heavy objects on top of the **TBUS-1-KWC**.

2.2 Recycling Kramer Products

The Waste Electrical and Electronic Equipment (WEEE) Directive 2002/96/EC aims to reduce the amount of WEEE sent for disposal to landfill or incineration by requiring it to be collected and recycled. To comply with the WEEE Directive, Kramer Electronics has made arrangements with the European Advanced Recycling Network (EARN) and will cover any costs of treatment, recycling and recovery of waste Kramer Electronics branded equipment on arrival at the EARN facility. For details of Kramer's recycling arrangements in your particular country go to our recycling pages at www.kramerav.com/support/recycling/.

3 Overview

The **TBUS-1-KWC** is a modular furniture-mounted connection bus enclosure that is easily installed into a table or podium top.

Once assembled, the **TBUS-1-KWC** lets you connect any equipment to the room's presentation system installations via cable access or passive interfaces (see [Figure 1](#)). When the cables are not in use, they can be stored inside the unit, covered by the lid and out of sight.

The **TBUS-1-KWC** features a built-in Qi standard compliant charging spot that enables you to charge your mobile device by simply placing it on the charging spot.



If your mobile device does not feature wireless charging, you can connect it to one of the receivers included in the package and then place it on the charging spot. Note that additional receivers can be purchased separately.

In addition, the **TBUS-1-KWC** features:

- A modular design, letting you tailor the **TBUS-1-KWC** according to your requirements.
- Black or clear sandblast finish, anodized aluminium lid.
- Special openings for cable pass-through.
- Height adjustment screw holes to set the inner frame (ordered separately) to the desired height.
- Single or dual power socket openings that are suitable for any of the following power sockets: for the USA, the UK, Switzerland, Germany (the Europlug), Belgium-France, Italy, Australia, Israel, Brazil, South Africa or "Universal" for use anywhere (see compatibility restrictions in [Section 7](#)).

Order the power sockets separately from Kramer Electronics



Figure 1: TBUS-1-KWC inside a Table

4 Defining the TBUS-1-KWC

This section defines the **TBUS-1-KWC**.

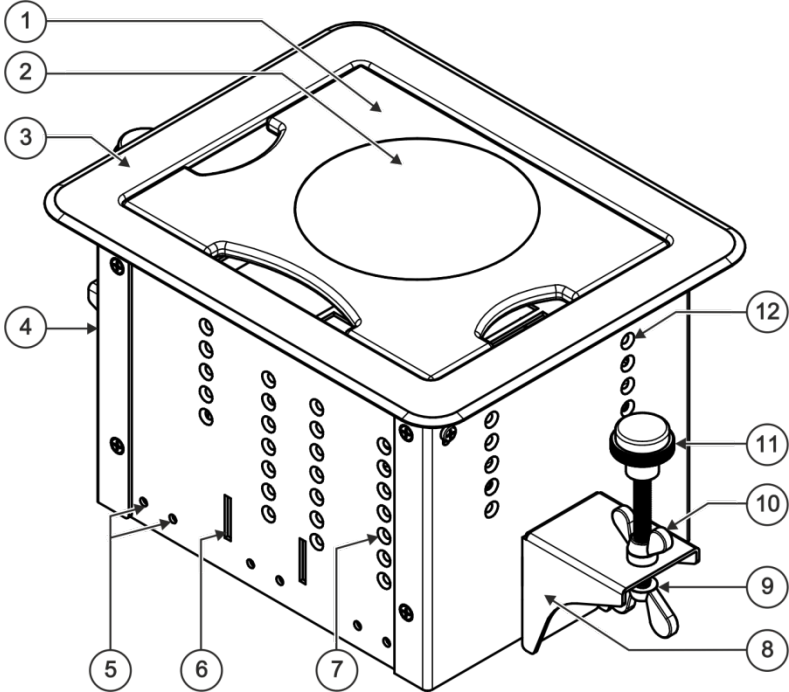

Figure 2: TBUS-1-KWC Table Connection Bus – Front View

#	Feature	Function
1	Black/Clear Anodized Sandblast Textured Lid	Includes an opening for cable pass-through; covers the inner frame, leaving the table surface neat and tidy.
2	Charging Spot	For mobile device wireless charging
3	Outer Rim	Fits over the table surface. A protective rubber guard protects the outer rim during shipping. Remove it before installing the unit.
4	Enclosure	Inserted into the table cut out
5	Tie Holes	Insert the self-locking tie through the holes to fix the pass-through cables to the inside walls of the unit.
6	Bracket Grooves	For attaching the two mounting brackets on opposite sides.
7	TOOL Height Adjustment Screw Holes	Used for installing Kramer TOOLS.

#	Feature	Function
8	Table Clamping Set	Mounting Brackets (2 units)
9		Mounting Butterfly Screws
10		Locking Butterfly Screws
11		Rubber Protectors
12	Inner Frame Height Adjustment Screw Holes	For adjusting the height of the mounted inner frame
13	Power Spot Wiring	Connect to a power source (see Figure 3)

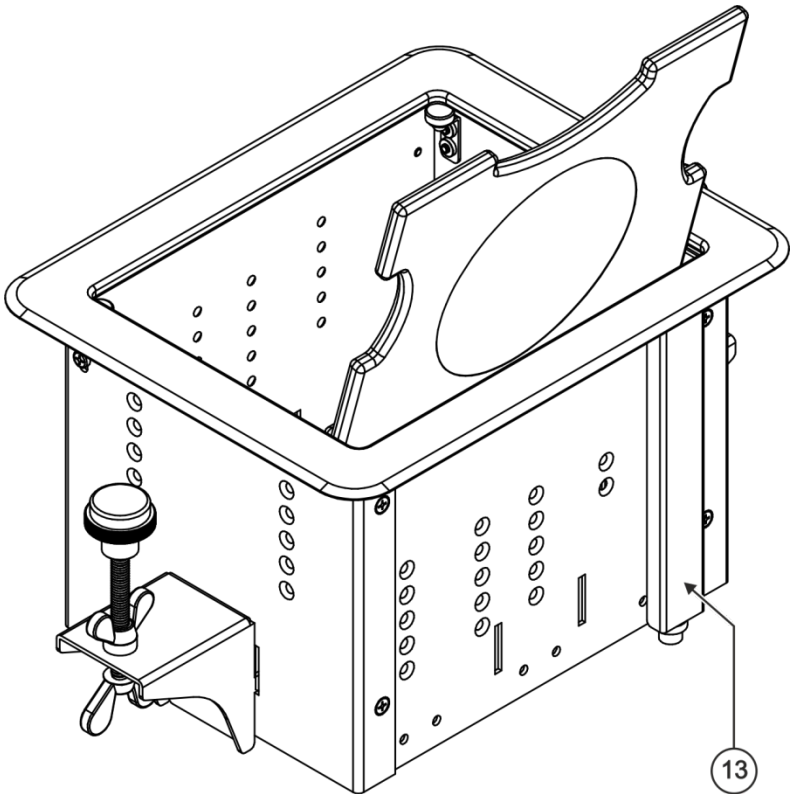
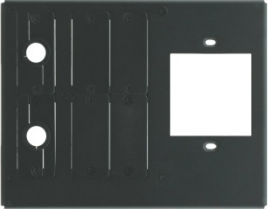
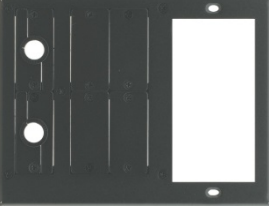
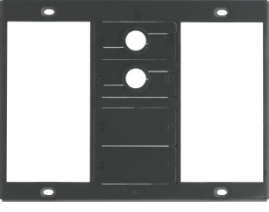
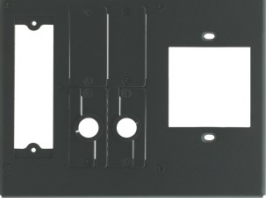

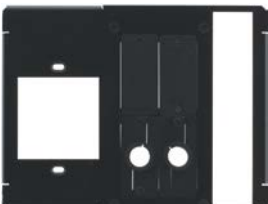

Figure 3: TBUS-1-KWC – Rear View

4.1 TBUS-1-KWC Optional Inner Frames

The following inner frames can be installed in the **TBUS-1-KWC** enclosure:

Inner Frames for TBUS-1A	Specifications
	<p>T1AF-16 (P/N: 80-000299)</p> <p>1 opening for 1 power socket 2 cable pass-through inserts 4 blank inserts</p>
	<p>T1AF-26 (P/N: 80-000399)</p> <p>1 opening for 2 power sockets 2 cable pass-through inserts 4 blank inserts</p>
	<p>T1AF-44 (P/N: 80-000499)</p> <p>2 openings for 4 power sockets 2 cable pass-through inserts 2 blank inserts</p>
	<p>T1AF-14L (P/N: 80-000699)</p> <p>1 opening for 1 power socket 1 opening for Kramer SI-1VGA / RC-3TB 2 cable pass-through inserts 2 blank inserts</p>

Inner Frames for TBUS-1A	Specifications
	<p>T1AF-1T3 (P/N: 80-005199)</p> <p>1 opening for 1 power socket 2 openings for 3 Kramer TOOLS</p>
	<p>T1AF-14T (P/N: 80-005299)</p> <p>1 opening for 1 power socket 1 opening for 1 Kramer TOOL 2 cable pass-through inserts 2 blank inserts</p>



Custom made inner frames can be designed if required.
Contact Kramer Electronics for more details.

4.2 TBUS-1-KWC Optional Inserts

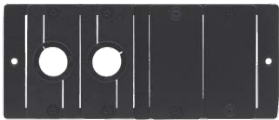
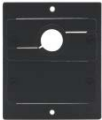
Accessories	Description
<p>Inserts</p>	<p>You can install any wall plate devices as well as any of the single or dual inserts—see our Web site for details.</p>
	<p>T-RC8IR (P/N: 80-000599)</p> <p>1 special panel to fit the Kramer RC-8IR Control Panel into the appropriate frame (P/N 80-000399 or P/N 80-000499 instead of two power sockets)</p>
	<p>T-4INSERT (P/N: 60-100199)</p> <p>The T-4INSERT kit can be installed inside a dual power socket opening and includes:</p> <p>2 single cable pass-through insert 2 dual cable pass-through insert</p>
	<p>T-2INSERT (P/N: 80-00006699)</p> <p>The T-2INSERT kit can be installed inside a single power socket opening and includes:</p> <p>1 single cable pass-through insert 1 dual cable pass-through insert</p>

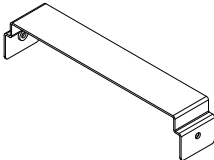





Accessories	Description
	T-TBLANK (P/N: 80-005099) This TOOL blank covers a TOOL opening for the T1AF-1T3 (P/N: 80-005199) and T1AF-14T (P/N: 80-005299) inner frames





4.3 Power Socket Options

Inner frames support installing one or more of the following power socket assemblies.

Note: The Brazilian power sockets are supplied as dual power sockets in a single power socket assembly (see table below).

4.3.1 Single Power Socket Assemblies

Power Socket Type	Power Specs	Power Socket Type	Power Specs
Universal: 	TS-1U (80-000899) 100-240V AC, 50/60Hz, 5A Maximum 5A per power outlet	Fully compatible with power plugs in the UK, India, Italy and Denmark, as well as with the 2-prong Europlug. Partially compatible (if the polarity is reversed) with plugs in China, Switzerland, Israel and the USA. The universal socket does not supply grounding to plugs in Central Europe and France and so you should order country specific sockets instead. Not compatible with South African plugs.	
USA: 	TS-1US (80-000999) 100-240V AC, 50/60Hz, 5A Maximum 5A per power outlet	UK 	TS-1UK (91-000022) 100-240V AC, 50/60Hz, 5A Maximum 5A per power outlet
Belgium and France: 	TS-1FR (80-001399) 100-240V AC, 50/60Hz, 5A Maximum 5A per power outlet	Israel: 	TS-1IL (80-001799) 220V AC, 50/60Hz, 5A Maximum 5A per power outlet
Germany and EU: 	TS-1DE (80-001299) 100-240V AC, 50/60Hz, 5A Maximum 5A per power outlet	South Africa 	TS-1ZA (80-001699) 100-240V AC, 50/60Hz, 5A Maximum 5A per power outlet

Power Socket Type	Power Specs	Power Socket Type	
Italy: 	TS-1IT (80-001499) 100-240V AC, 50/60Hz, 5A Maximum 5A per power outlet	Australia: 	TS-1AU (80-001599) 100-240V AC, 50/60Hz, 5A Maximum 5A per power outlet
Switzerland 	TS-1CH (80-000027) 100-240V AC, 50/60Hz, 5A Maximum 5A per power outlet	Brazil 	TS-BR (80-000034) 100-240V AC, 50/60Hz, 5A Maximum 5A/2.5A per power outlet

4.3.2 Dual Power Socket Assemblies

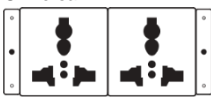
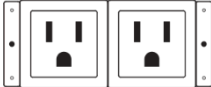
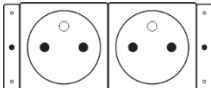
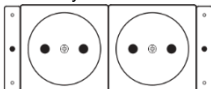
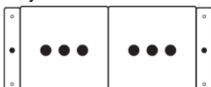
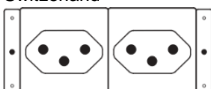
Dual Power Socket Assemblies:	Power Specs
Universal: 	TS-2U (80-001899) 100-240V AC, 50/60Hz, 5A Maximum 5A/2.5A per power outlet
USA: 	TS-2US (80-001999) 100-240V AC, 50/60Hz, 5A Maximum 5A/2.5A per power outlet
Belgium and France: 	TS-2FR (80-002299) 100-240V AC, 50/60Hz, 5A Maximum 5A/2.5A per power outlet
Germany and EU: 	TS-2DE (80-002199) 100-240V AC, 50/60Hz, 5A Maximum 5A/2.5A per power outlet
Italy 	TS-2IT (80-002399) 100-240V AC, 50/60Hz, 5A Maximum 5A/2.5A per power outlet
Switzerland 	TS-2CH (80-000026) 220V AC, 50/60Hz, 5A Maximum 5A/2.5A per power outlet

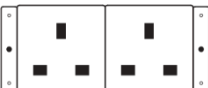
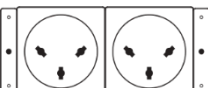
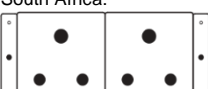
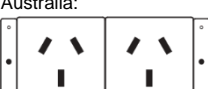
Dual Power Socket Assemblies:	Power Specs
UK 	TS-1UK (91-000023) 220V AC, 50/60Hz, 5A Maximum 5A/2.5A per power outlet
Israel: 	TS-2IL (80-002699) 220V AC, 50/60Hz, 5A Maximum 5A/2.5A per power outlet
South Africa: 	TS-2ZA (80-002599) 220V AC, 50/60Hz, 5A Maximum 5A/2.5A per power outlet
Australia: 	TS-2AU (80-002499) 100-240V AC, 50/60Hz, 5A Maximum 5A/2.5A per power outlet

4.4 Power Cord Options

You can order any of the following power cords to use with a modular TBUS:

Power Cord Type	Description	P/N
6ft/110V (North America)	C-AC/US (110V)	91-000099
6ft/125V (Japan)	C-AC/JP (125V)	91-000699
6ft/220V (Europe)	C-AC/EU (220V)	91-000199
6ft/220V (Israel)	C-AC/IL (220V)	91-000999
6ft/250V (UK)	C-AC/UK (250V)	91-000299
6ft/250V (India)	C-AC/IN (250V)	91-001099
6ft/250V/10A (China)	C-AC/CN (250V)	91-001199
6ft/250V/10A (South Africa)	C-AC/ZA (250V)	91-001299

To use one power cord for a 4-socket configuration, you can order any of the following types of power cords separately:

Power Cord Type	Description	P/N
110V Y-version (6ft), North America	C-ACY/US	91-000399
220V Y-version (6ft), Europe	C-ACY/EU	91-000499
240V Y-version (6ft), UK	C-ACY/UK	91-000599

5 Installing the TBUS-1-KWC

To install the TBUS-1-KWC:

1. Assemble the inner frame (see [Section 5.1](#)).
2. Install the inner frame (see [Section 5.2](#)).
3. Cut an opening in the table (see [Section 5.3](#)).
4. Insert the unit through the opening and secure it to the table (see [Section 5.4](#)).
5. Connect the cables (see [Section 5.5](#)).
6. Insert the pass-through cables (see [Section 5.6](#)).
7. Adjust the height of the inner frame (see [Section 5.7](#)).

5.1 Assembling the Inner Frame

The modules mounted on the inner frame can include single inserts and/or dual inserts as well as power sockets and various Kramer devices. This section describes how to assemble these modules.



Each module kit is supplied with detailed assembly instructions.

5.1.1 Mounting the Inserts

You can rearrange or remove any of the plates mounted on the inner frame and replace them with Kramer passive wall plates or connector modules for interfacing A/V type signals.

To mount a Kramer insert or connector module:

1. Unscrew the two screws that fasten the blank plate to the inner frame and remove the blank plate.
2. Place the required Kramer insert over the opening, insert the two screws to fix the Kramer insert in place, and tighten them.

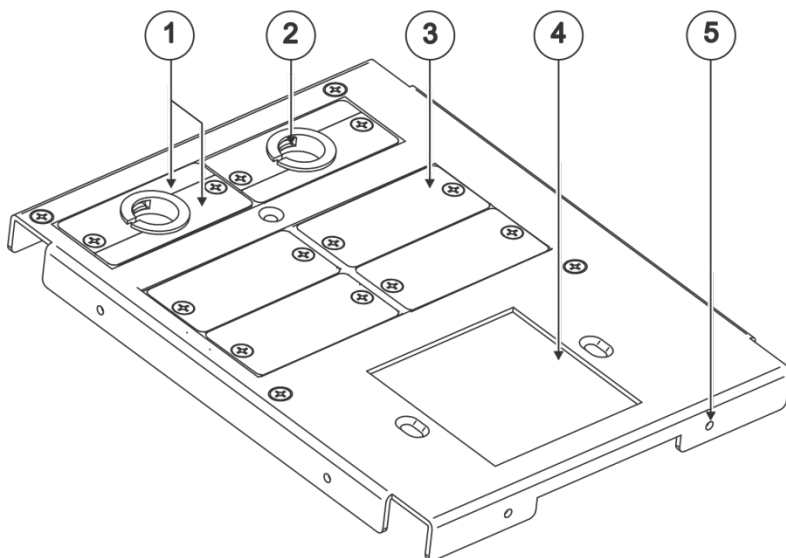

Figure 4: TBUS-1-KWC Inner Frame (P/N: 80-000299)

#	Feature	Function
1	Split Brackets	Support the split grommet for the pass through-cables
2	Split Grommets	Push apart slightly to insert cables
3	Blank Plates	Four blank covers that can be replaced with wall plates as required
4	Power Socket Opening	Suitable for a single power socket or the T-2INSERT
5	Adjustable Height Screw Holes	For adjusting the height of the inner frame

5.1.2 Mounting the Power Socket Assemblies

To mount the power socket, place the power socket under the frame in its appropriate place and tighten with the two screws (supplied).



Power socket kits are supplied with assembly instructions.

5.1.3 Mounting a Kramer TOOL

To mount a TOOL (for example, to the T1AF-14T), as shown in [Figure 5](#):

1. Screw the spacers to their designated places (one on each side).
2. Insert the TOOL, from beneath, through the TOOL opening.
3. Screw the screws (one on each side) through the frame holes and spacers.

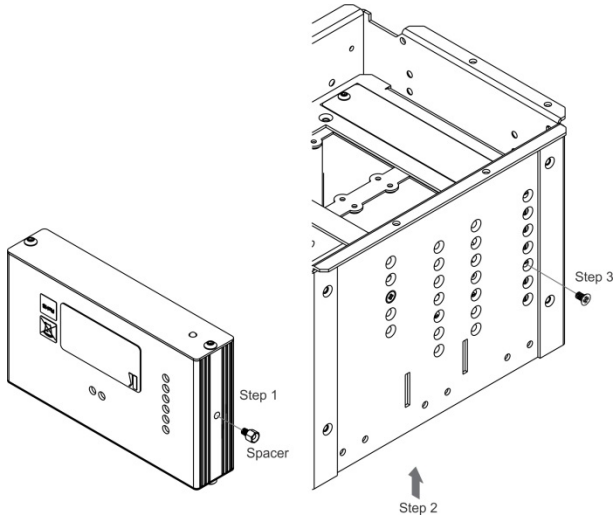

Figure 5: Installing a Kramer TOOL

5.1.4 Installing the TOOL Blank

To install the T-TBLANK, as shown in [Figure 6](#):

1. Insert the **T-TBLANK** from beneath, through the TOOL opening.
2. Screw the screws (one on each side) through the frame.

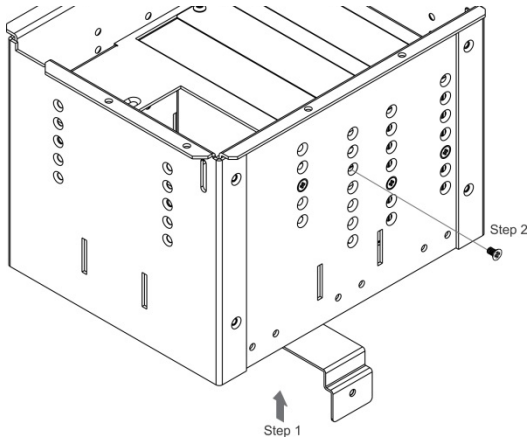

Figure 6: Installing the T-TBLANK TOOL Blank

5.1.5 Mounting the Special Panel for RC-8IR

The Kramer **T-RC8IR** for the **TBUS-1-KWC** Table Connection bus is used to fit the Kramer **RC-8IR** Control Panel into the appropriate frame (P/N 80-000399 or P/N 80-000499 instead of two power sockets).

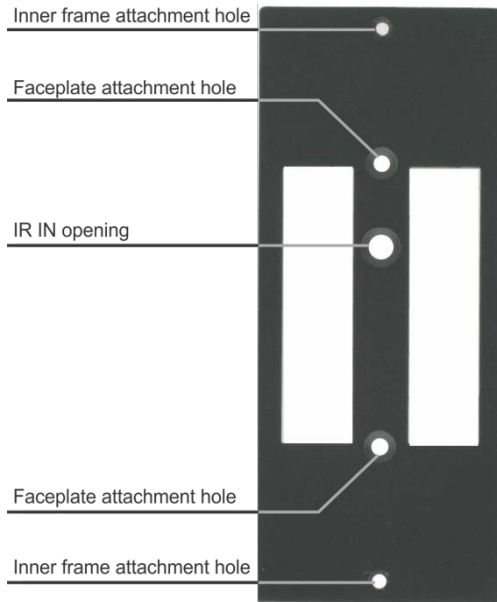

Figure 7: T-RC8IR (P/N: 80-000599)

To replace the RC-8IR faceplate:

1. Unscrew the two faceplate attachment screws and remove the **RC-8IR** faceplate before installing the **T-RC8IR**.

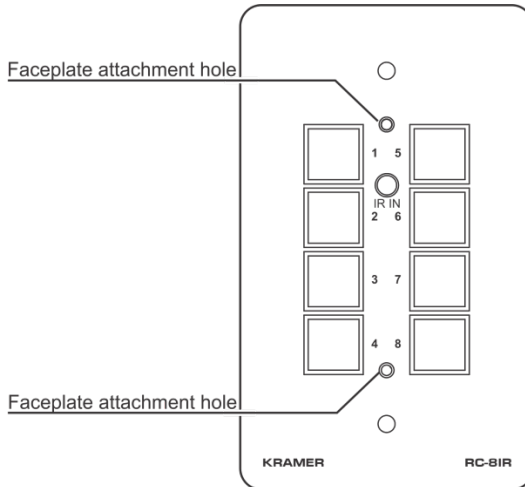

Figure 8: RC-8IR Faceplate Holes Table Connection Bus

2. Place the **T-RC8IR** over the **RC-8IR** enclosure so that both face plate holes are aligned with the face plate holes on the **RC-8IR** enclosure and the IR IN receiver fits into the IR IN opening.
3. Insert the faceplate screws through the **T-RC8IR** and **RC-8IR** enclosure faceplate holes, and tighten.

To install the T-RC8IR:

1. Insert the **T-RC8IR** assembly through the dual power socket opening from beneath.
2. Use the two power socket screws to tighten the **T-RC8IR** assembly in place.

5.1.6 Installing the SI-1VGA / RC-3TB

To install the **SI-1VGA / RC-3TB** module, place it under the designated opening in the **T1AF-14L** (P/N: 80-000699) and then screw and tighten it in place using the two screws supplied with the inner frame.

5.2 Installing the Inner Frame

To install the inner frame:

1. Place the inner frame inside the **TBUS-1-KWC** enclosure.
2. Set the required height using your fingers to bring the inner frame to the desired position, screw and tighten it in place using the height adjustment screws (supplied with the inner frame).



Inner frame kits come with assembly instructions.

5.3 Cutting an Opening in the Table

To cut an opening in the table:

1. Place the included cut out template (that is included with your **TBUS-1-KWC**) on the surface of the table exactly where you want to install the **TBUS-1-KWC**.
2. Attach the template to the table with the included screws (if using the cut out template).
3. Following the **inside** edge of the template, cut a hole in the table surface with a sabre or keyhole saw according to the dimensions shown in [Figure 9](#) (not to scale).



The thickness of the table should be 76 mm / 3 inches or less.

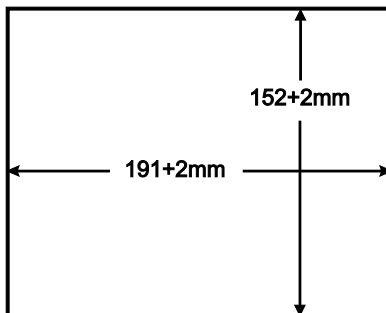

Figure 9: Cut Out Dimensions

4. Unscrew and remove the template from the surface of the table and clean the table surface.

Take care not to damage the table.

If needed, you can download a full-scale template from our Web site.



Kramer Electronics is not responsible for any damage caused to the table.

5.4 Inserting the TBUS-1-KWC through the Cut Out Opening

To install TBUS-1-KWC in the opening:

1. Remove the protective rubber guard from around the outer rim of the **TBUS-1-KWC** housing. **Beware of the sharp edge!**
2. Carefully insert the unit into the prepared opening (see [Figure 10](#)).
3. Attach the power supply under the table using the power supply bracket (supplied with the package).
4. Take the support brackets under the table and place them into the support bracket grooves on both sides of the unit (see [Figure 2](#), item 6).
5. Verify proper alignment of the unit before tightening the mounting screws.
6. Tighten both mounting butterfly screws upward until they reach the table surface (from underneath). Tighten firmly (see [Figure 10](#)).
7. Tighten the locking butterfly screws downward until tight against the mounting bracket.

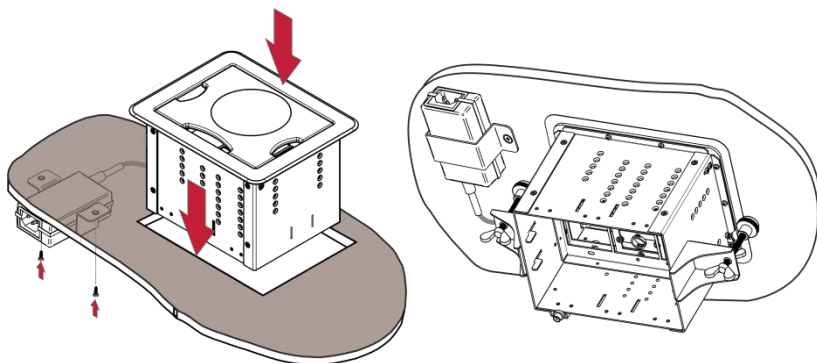

Figure 10: Inserting TBUS-1-KWC into the Prepared Opening

5.5 Connecting the Cables

Connect the Charging spot to the power supply and the power supply to the mains electricity (the power cord is purchased separately, see [Section 4.3](#)).

To connect the cables when replacing blank inserts with connector inserts (for example, VGA, audio, HDMI and so on):

1. Insert the cables to their appropriate connectors from underneath.
2. Secure the cables to the tie holes on the **TBUS-1-KWC**.
Do not secure the cables too tightly or too loosely. Leave a small amount of slack.

5.6 Inserting the Pass-through Cables

To insert the pass through cables (for example, to connect a laptop):

1. Remove the two screws attaching the split pass-through bracket.
2. Remove the split grommet.
3. Insert the cable through the rectangular opening.
4. Open the split grommet slightly and insert the required cables.

5. Place the split bracket around the grommet and position this assembly over the inner frame.
6. Place the two screws appropriately and tighten the split bracket together with the grommet and inserted cables to the inner frame.
7. Insert the self-locking ties through the tie holes to secure the cables to the inside walls of the enclosure.

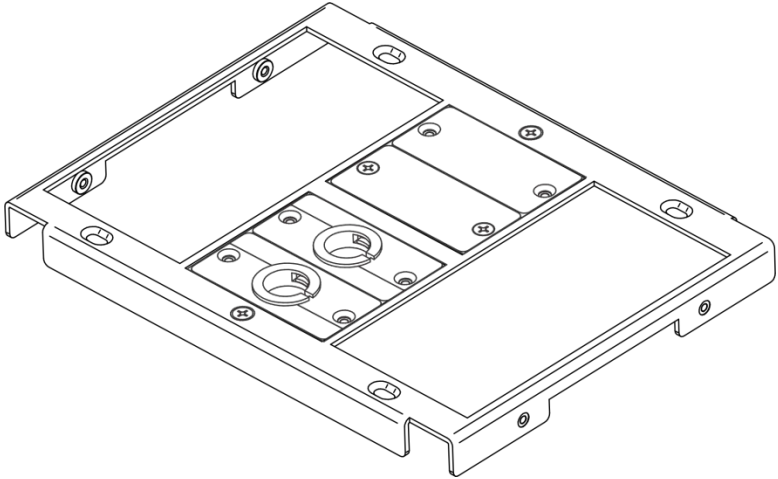

Figure 11: Cable Pass-through Insert (P/N: 80-000499)

5.7 Adjusting the Height of the Inner Frame

If needed, you can adjust the inner frame height to accommodate large or bulky cables.

To adjust the inner frame height:

1. Remove the height adjustment screws, while supporting the surface from underneath with your fingers.
2. Raise or lower the inner frame to the required height, insert the screws, and tighten them in place.

6 Using the TBUS-1-KWC

Once the **TBUS-1-KWC** is installed, you can easily customize it to suit your own requirements by plugging in the required A/V equipment, as illustrated in the example in [Figure 12](#).

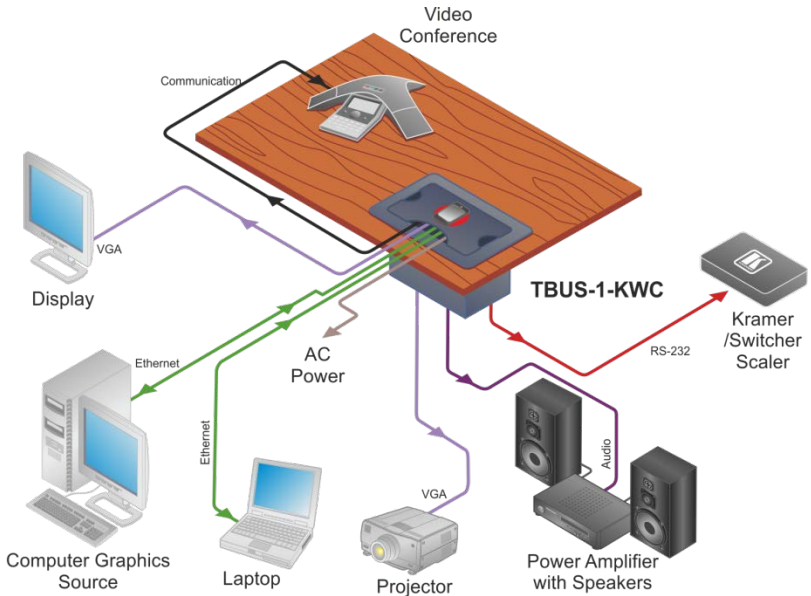

Figure 12: TBUS-1-KWC Boardroom Installation

6.1 Using the Wireless Charger

To use the Kramer Wireless charger on the lid:

1. Make sure that the charging spot power cable is connected.
2. If your mobile device supports wireless charging, place it on the charging spot until it is fully charged.



If your mobile device does not support wireless charging, you can connect it to either the **KWC-MUSB** Micro USB receiver or the **KWC-LTN** lightning receiver (see [Section 6.2](#)), supplied with the package.

Additional receivers can be purchased separately.

Note that you can only charge one mobile device at a time.

6.2 Using the Receivers

The Kramer **KWC-MUSB** and **KWC-LTN** wireless charging receivers (one of each is supplied with the **TBUS-1-KWC**). These receivers can be used with Kramer Wireless Charging (KWC) products.



These receivers are used for mobile devices that **DO NOT** have a built-in wireless charging receiver.

Mobile devices with a built-in wireless receiver, compliant with the Qi standard, can be placed directly on the charging spot.

The **KWC-MUSB** Micro USB receiver (see [Figure 13](#)) and **KWC-LTN** lightning receiver (see [Figure 14](#)) are wireless power receivers that utilize electromagnetic induction to charge mobile devices wirelessly and are compatible with the Qi standard for wireless chargers (with security eyeholes).



Figure 13: KWC-MUSB Micro USB Receiver



Figure 14: KWC-LTN Lightning Receiver



Figure 15: Receiver Underside



Additional receivers can be purchased separately.

6.3 Using the Wireless Charger

To use the Kramer receivers:

1. Connect your mobile device to either the **KWC-MUSB** Micro USB receiver or the **KWC-LTN** lightning receiver, as required.
2. Place the mobile device with the attached receiver centered on the charging spot (correct side facing the charging spot, see [Figure 15](#)) until it's fully charged.



You can only charge one mobile device via the charging spot at a time.

When charging a mobile device, do not place any metal or magnetic objects over the receiver.

Charging a mobile device using the receiver in the vicinity of pacemakers, hearing aids, or similar medical electronic devices may interfere with the function of these devices.

Make sure the receivers are used in a cool and well-ventilated environment and away from flammable and explosive objects.

Avoid using the receivers in extreme temperatures or high humidity.

6.4 Securing Wireless Charging Receivers

Use the security springs and bracket (included) to secure the wireless charging receivers to the **TBUS-1-KWC**.

To secure the wireless charging receivers:

1. Thread the security spring loop through the eyehole on the security bracket.
2. Pull the loop on the other side of the spring through the threaded loop.



Figure 16: Connecting to the Security Bracket

3. Thread the free loop through the security eyehole on the wireless charging receiver.



Figure 17: Threading the Loop through the Receiver Eyehole

4. Pull the security bracket through the threaded loop, so that the bracket is looped on one side and the receiver on the other side.



Figure 18: Security Spring with Bracket and Receiver



You can attach one or more wireless receivers in the same way (by passing all the springs through the loop in step 4).

5. Mount the security bracket onto the inner frame (see [Section 5.1.1](#)).

7 Technical Specifications of the TBUS-1-KWC

POWER SOURCE (AC power limits):	Single Socket Assemblies:	
	Universal	100-240V AC, 50/60Hz, 5A Maximum 5A per power outlet
	<p>Fully compatible with power plugs in the UK, India, Italy and Denmark, as well as with the 2-prong Europlug.</p> <p>Partially compatible (if the polarity is reversed) with plugs in China, Switzerland, Israel and the USA. The universal socket does not supply grounding to plugs in Central Europe and France (you should order country specific sockets instead).</p> <p>Not compatible with South African plugs.</p>	
	USA	100-240V AC, 50/60Hz, 5A Maximum 5A per power outlet
	Germany and EU	100-240V AC, 50/60Hz, 5A Maximum 5A per power outlet
	Belgium and France	100-240V AC, 50/60Hz, 5A Maximum 5A per power outlet
	Italy	100-240V AC, 50/60Hz, 5A Maximum 5A per power outlet
	Australia	100-240V AC, 50/60Hz, 5A Maximum 5A per power outlet
	Israel	220V AC, 50/60Hz, 5A Maximum 5A per power outlet
	South Africa	100-240V AC, 50/60Hz, 5A Maximum 5A per power outlet
	Switzerland	100-240V AC, 50/60Hz, 5A Maximum 5A per power outlet
	UK	100-240V AC, 50/60Hz, 5A Maximum 5A per power outlet
	Brazil	100-240V AC, 50/60Hz, 5A Maximum 5A/2.5A per power outlet
	Dual Power Kit Assemblies:	
	Universal	100-240V AC, 50/60Hz, 5A Maximum 5A/2.5A per power outlet
	USA	100-240V AC, 50/60Hz, 5A Maximum 5A/2.5A per power outlet
	Belgium and France	100-240V AC, 50/60Hz, 5A Maximum 5A/2.5A per power outlet
	Germany and EU	100-240V AC, 50/60Hz, 5A Maximum 5A/2.5A per power outlet
	Italy	100-240V AC, 50/60Hz, 5A Maximum 5A/2.5A per power outlet
	Israel	220V AC, 50/60Hz, 5A Maximum 5A/2.5A per power outlet
	Switzerland	100-240V AC, 50/60Hz, 5A Maximum 5A per power outlet
	UK	100-240V AC, 50/60Hz, 5A Maximum 5A per power outlet
	Australia	100-240V AC, 50/60Hz, 5A Maximum 5A per power outlet
South Africa	100-240V AC, 50/60Hz, 5A Maximum 5A per power outlet	
FUSE RATING:	T 6.3A 250V	

POWER CONSUMPTION:	Charging spot: 5V DC, 1A
CHARGING EFFICIENCY:	70%
CHARGING POWER OUTPUT:	700 mA Max
SAFETY REGULATORY COMPLIANCE:	CE, FCC
STANDARD:	Qi
OPERATING TEMPERATURE RANGE:	+5 to +45 Deg. Centigrade
OPERATING HUMIDITY RANGE:	10 to 90% RHL, non-condensing
STORAGE TEMPERATURE RANGE:	-20 to +70 Deg. Centigrade
STORAGE HUMIDITY RANGE:	5 to 95% RHL, non-condensing
DIMENSIONS:	22.1cm x 18.2cm x 13cm (8.17" x 5.88" x 5.13") W, D, H
WEIGHT:	Gross weight: 2.3kg (5.07lbs) approx. TBUS-1-KWC with table clamps: 1.75kg (3.6lbs) approx.; Metal template: 0.125kg (0.28lbs) approx.
ACCESSORIES:	Power cord, six self-locking ties, metal template, 1 KWC-MUSB, 1 KWC-LTN (see separate specifications in Section 7.1), 1 security bracket, 2 security springs, power supply, power supply bracket
OPTIONS:	Inner frames, passive wall plates and interfaces, power socket kits, power supply, bracket for power supply
Specifications are subject to change without notice at www.kramerav.com	

7.1 Technical Specifications of the KWC-MUSB and KWC-LTN

PORT:	KWC-MUSB: micro USB receiver KWC-LTN: lightning receiver
LED INDICATORS:	ON (blue)
CHARGING EFFICIENCY:	70%
CHARGING POWER:	5V DC, 700 mA Max
STANDARD:	Qi
SAFETY REGULATORY COMPLIANCE:	CE, FCC
OPERATING TEMPERATURE:	0° to +40°C (32° to 104°F)
STORAGE TEMPERATURE:	-40° to +70°C (-40° to 158°F)
HUMIDITY:	10% to 90%, RHL non-condensing
DIMENSIONS:	3.7cm x 5cm x 0.85cm (1.72" x 7.2" x 1.7") W, D, H
WEIGHT:	Net: 0.012kg (0.03lb) Gross: 0.032kg (0.07lb)
COLORS:	KWC-MUSB: light blue KWC-LTN: light green
Specifications are subject to change without notice at www.kramerav.com	

The warranty obligations of Kramer Electronics Inc. ("Kramer Electronics") for this product are limited to the terms set forth below.

What is Covered

This limited warranty covers defects in materials and workmanship in this product.

What is Not Covered

This limited warranty does not cover any damage, deterioration or malfunction resulting from any alteration, modification, improper or unreasonable use or maintenance, misuse, abuse, accident, neglect, exposure to excess moisture, fire, improper packing and shipping (such claims must be presented to the carrier), lightning, power surges, or other acts of nature. This limited warranty does not cover any damage, deterioration or malfunction resulting from the installation or removal of this product from any installation, any unauthorized tampering with this product, any repairs attempted by anyone unauthorized by Kramer Electronics to make such repairs, or any other cause which does not relate directly to a defect in materials and/or workmanship of this product. This limited warranty does not cover cartons, equipment enclosures, cables or accessories used in conjunction with this product.

Without limiting any other exclusion herein, Kramer Electronics does not warrant that the product covered hereby, including, without limitation, the technology and/or integrated circuit(s) included in the product, will not become obsolete or that such items are or will remain compatible with any other product or technology with which the product may be used.

How Long this Coverage Lasts

The standard limited warranty for Kramer products is seven (7) years from the date of original purchase, with the following exceptions:

1. All Kramer VIA products are covered by a standard three (3) year warranty for VIA hardware and a standard one (1) year warranty for firmware and software updates. (An extended software warranty plan for an additional 2 years can be purchased separately).
2. All Kramer fiber optic cables and adapters, all Kramer speakers and Kramer touch panels are covered by a standard one (1) year warranty.
3. All Kramer Cobra products, all Kramer Calibre products, all Kramer Minicom digital signage products, all HighSecLabs products, all streaming, and all wireless products are covered by a standard three (3) year warranty.
4. All Sierra Video MultiViewers are covered by a standard five (5) year warranty.
5. Sierra switchers & control panels are covered by a standard seven (7) year warranty (excluding power supplies and fans that are covered for three (3) years).
6. K-Touch software is covered by a standard one (1) year warranty for software updates.
7. All Kramer passive cables are covered by a ten (10) year warranty.

Who is Covered

Only the original purchaser of this product is covered under this limited warranty. This limited warranty is not transferable to subsequent purchasers or owners of this product.

What Kramer Electronics Will Do

Kramer Electronics will, at its sole option, provide one of the following three remedies to whatever extent it shall deem necessary to satisfy a proper claim under this limited warranty:

1. Elect to repair or facilitate the repair of any defective parts within a reasonable period of time, free of any charge for the necessary parts and labor to complete the repair and restore this product to its proper operating condition. Kramer Electronics will also pay the shipping costs necessary to return this product once the repair is complete.
2. Replace this product with a direct replacement or with a similar product deemed by Kramer Electronics to perform substantially the same function as the original product.
3. Issue a refund of the original purchase price less depreciation to be determined based on the age of the product at the time remedy is sought under this limited warranty.

What Kramer Electronics Will Not Do Under This Limited Warranty

If this product is returned to Kramer Electronics or the authorized dealer from which it was purchased or any other party authorized to repair Kramer Electronics products, this product must be insured during shipment, with the insurance and shipping charges prepaid by you. If this product is returned uninsured, you assume all risks of loss or damage during shipment. Kramer Electronics will not be responsible for any costs related to the removal or re-installation of this product from or into any installation. Kramer Electronics will not be responsible for any costs related to any setting up this product, any adjustment of user controls or any programming required for a specific installation of this product.

How to Obtain a Remedy Under This Limited Warranty

To obtain a remedy under this limited warranty, you must contact either the authorized Kramer Electronics reseller from whom you purchased this product or the Kramer Electronics office nearest you. For a list of authorized Kramer Electronics resellers and/or Kramer Electronics authorized service providers, visit our web site at www.kramerav.com or contact the Kramer Electronics office nearest you.

In order to pursue any remedy under this limited warranty, you must possess an original, dated receipt as proof of purchase from an authorized Kramer Electronics reseller. If this product is returned under this limited warranty, a return authorization number, obtained from Kramer Electronics, will be required (RMA number). You may also be directed to an authorized reseller or a person authorized by Kramer Electronics to repair the product.

If it is decided that this product should be returned directly to Kramer Electronics, this product should be properly packed, preferably in the original carton, for shipping. Cartons not bearing a return authorization number will be refused.

Limitation of Liability

THE MAXIMUM LIABILITY OF KRAMER ELECTRONICS UNDER THIS LIMITED WARRANTY SHALL NOT EXCEED THE ACTUAL PURCHASE PRICE PAID FOR THE PRODUCT. TO THE MAXIMUM EXTENT PERMITTED BY LAW, KRAMER ELECTRONICS IS NOT RESPONSIBLE FOR DIRECT, SPECIAL, INCIDENTAL OR CONSEQUENTIAL DAMAGES RESULTING FROM ANY BREACH OF WARRANTY OR CONDITION, OR UNDER ANY OTHER LEGAL THEORY. Some countries, districts or states do not allow the exclusion or limitation of relief, special, incidental, consequential or indirect damages, or the limitation of liability to specified amounts, so the above limitations or exclusions may not apply to you.

Exclusive Remedy

TO THE MAXIMUM EXTENT PERMITTED BY LAW, THIS LIMITED WARRANTY AND THE REMEDIES SET FORTH ABOVE ARE EXCLUSIVE AND IN LIEU OF ALL OTHER WARRANTIES, REMEDIES AND CONDITIONS, WHETHER ORAL OR WRITTEN, EXPRESS OR IMPLIED. TO THE MAXIMUM EXTENT PERMITTED BY LAW, KRAMER ELECTRONICS SPECIFICALLY DISCLAIMS ANY AND ALL IMPLIED WARRANTIES, INCLUDING, WITHOUT LIMITATION, WARRANTIES OF MERCHANTABILITY AND FITNESS FOR A PARTICULAR PURPOSE. IF KRAMER ELECTRONICS CANNOT LAWFULLY DISCLAIM OR EXCLUDE IMPLIED WARRANTIES UNDER APPLICABLE LAW, THEN ALL IMPLIED WARRANTIES COVERING THIS PRODUCT, INCLUDING WARRANTIES OF MERCHANTABILITY AND FITNESS FOR A PARTICULAR PURPOSE, SHALL APPLY TO THIS PRODUCT AS PROVIDED UNDER APPLICABLE LAW.

IF ANY PRODUCT TO WHICH THIS LIMITED WARRANTY APPLIES IS A "CONSUMER PRODUCT" UNDER THE MAGNUSON-MOSS WARRANTY ACT (15 U.S.C.A. §2301, ET SEQ.) OR OTHER APPLICABLE LAW, THE FOREGOING DISCLAIMER OF IMPLIED WARRANTIES SHALL NOT APPLY TO YOU, AND ALL IMPLIED WARRANTIES ON THIS PRODUCT, INCLUDING WARRANTIES OF MERCHANTABILITY AND FITNESS FOR THE PARTICULAR PURPOSE, SHALL APPLY AS PROVIDED UNDER APPLICABLE LAW.

Other Conditions

This limited warranty gives you specific legal rights, and you may have other rights which vary from country to country or state to state.

This limited warranty is void if (i) the label bearing the serial number of this product has been removed or defaced, (ii) the product is not distributed by Kramer Electronics or (iii) this product is not purchased from an authorized Kramer Electronics reseller. If you are unsure whether a reseller is an authorized Kramer Electronics reseller, visit our web site at www.kramerav.com or contact a Kramer Electronics office from the list at the end of this document.

Your rights under this limited warranty are not diminished if you do not complete and return the product registration form or complete and submit the online product registration form. Kramer Electronics thanks you for purchasing a Kramer Electronics product. We hope it will give you years of satisfaction.

KRAMER



FC Tested To Comply
With FCC Standard
FOR HOME OR OFFICE USE



P/N: 2900-300503



Rev: 6



SAFETY WARNING

Disconnect the unit from the power supply before opening and servicing

For the latest information on our products and a list of Kramer distributors, visit our Web site where updates to this user manual may be found.

We welcome your questions, comments, and feedback.

www.KramerAV.com
info@KramerAV.com