

KONA[®]

Professional Performance,
Unparalleled Reliability

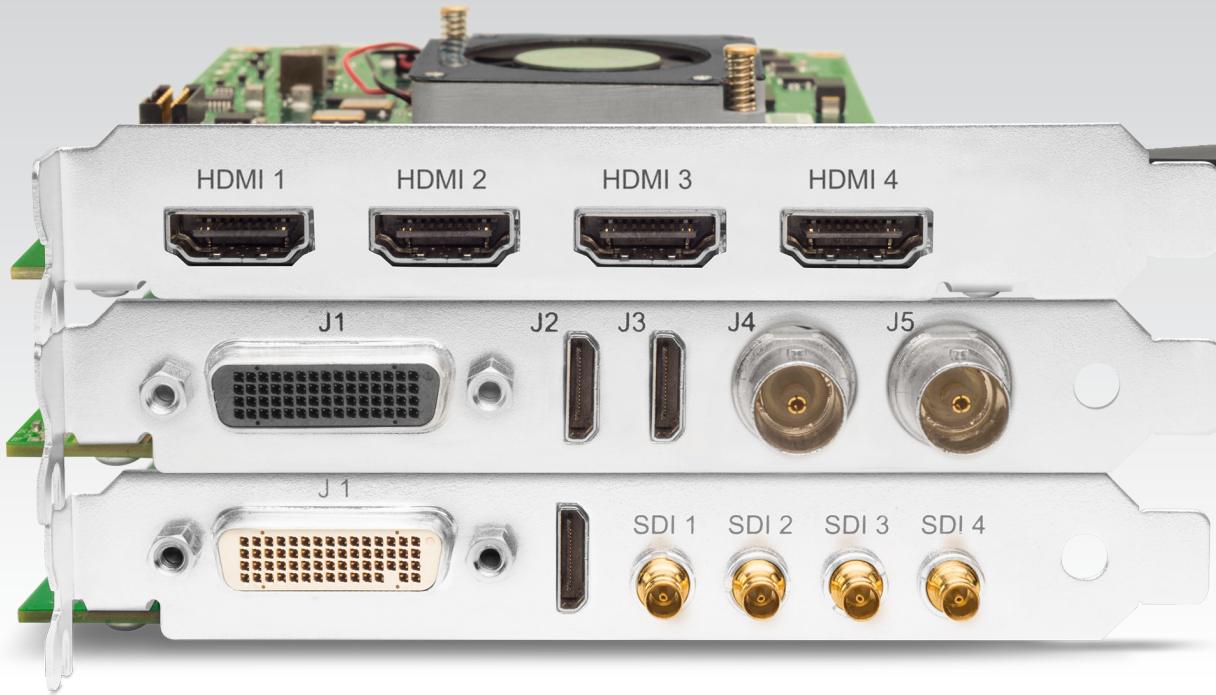

AJA[®]
VIDEO SYSTEMS

Professional Performance, Unparalleled Reliability

Built for the exacting demands of video professionals, KONA cards offer the highest quality video and audio I/O with a range of features tuned for your workflow.

AJA's KONA family of I/O and Capture cards delivers a complete range of performance and connectivity options to fit any budget or workflow from 4K to standard definition, from 12G-SDI and HDMI 2.0 to analog video and audio.

Whatever your workflow needs, KONA capture, display and mastering solutions for 4K/UltraHD, 2K/HD and SD workflows via SDI and HDMI on macOS®, Windows® or Linux® provides the best engine for your creative process.

In a world of SD, myriad HD standards, 2K, stereoscopic 3D, 4K workflows and multiplying HDR standards, KONA cards offer maximum connectivity like 3G-SDI, component, and HDMI, along with the flexibility of AJA's high quality conversion capabilities.*

KONA's superior 10-bit hardware-based up, down, cross-conversion offers you the ability to ingest to the resolution of your project while displaying and mastering live simultaneously to HD and SD as your needs require.

At AJA we understand that creative professionals have a range of software applications and platforms they prefer and need to work with. Using AJA's industry leading macOS and Windows® drivers and custom application plug-ins, all available in a single software package download, KONA cards support the broadest range of creative software, such as Apple® FCPX, Adobe® Premiere Pro®, Avid® Media Composer®, Telestream Wirecast® and more. Pick your applications of choice and KONA connects it to your world.

Built to the exacting standards of all AJA hardware, KONA cards are backed by our world class support network, three year international warranty and advanced exchange service.



KONA HDMI



KONA 1



KONA 4



KONA 3G



KONA LHi



KONA LHe Plus

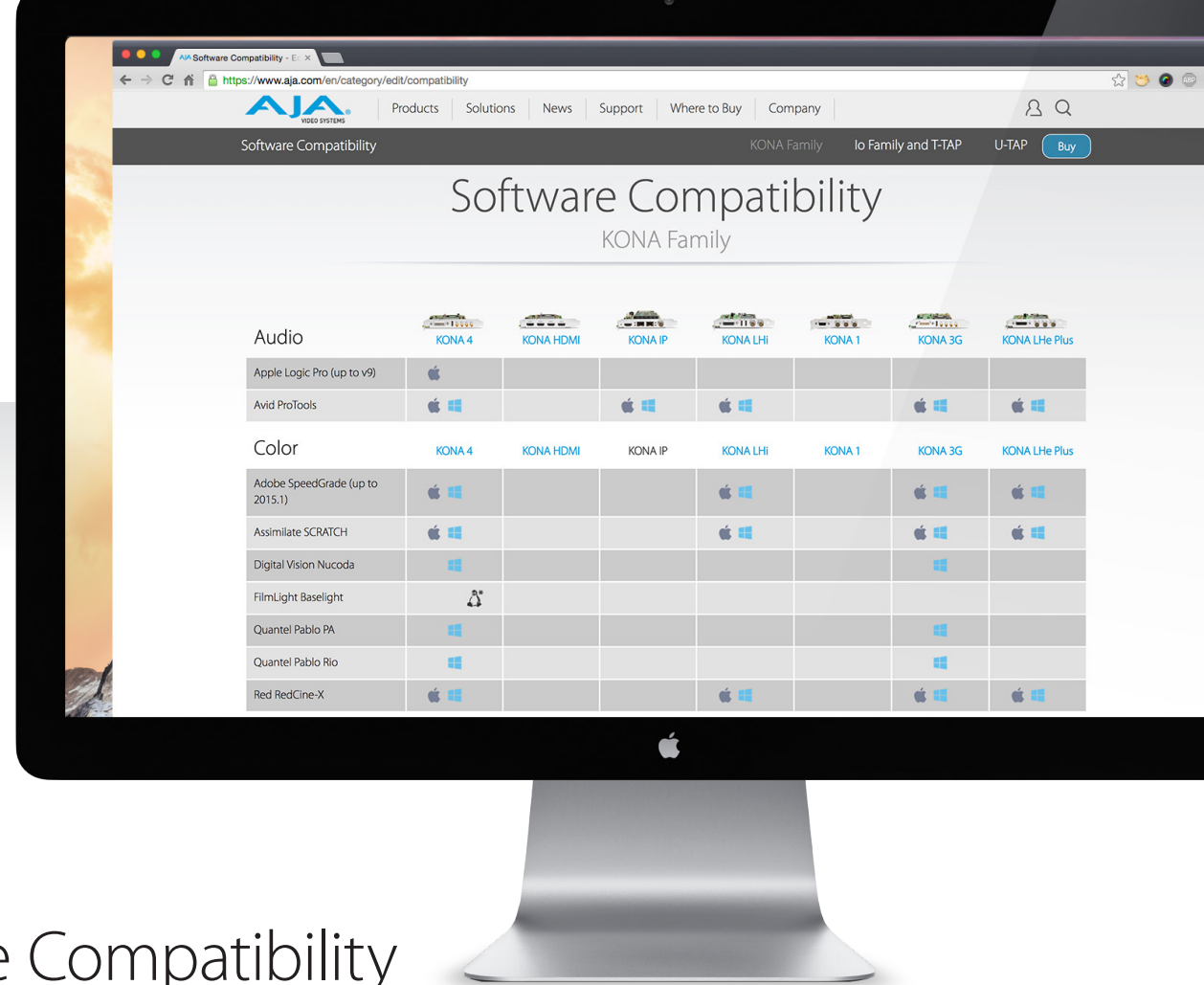

Audio

	KONA 4	KONA HDMI	KONA IP	KONA LHI	KONA 1	KONA 3G	KONA LHe Plus
Apple Logic Pro (up to v9)	Apple						
Avid ProTools	Apple Windows		Apple Windows	Apple Windows		Apple Windows	Apple Windows

Color

	KONA 4	KONA HDMI	KONA IP	KONA LHI	KONA 1	KONA 3G	KONA LHe Plus
Adobe SpeedGrade (up to 2015.1)	Apple Windows			Apple Windows		Apple Windows	Apple Windows
Assimilate SCRATCH	Apple Windows			Apple Windows		Apple Windows	Apple Windows
Digital Vision Nucoda	Windows					Windows	
FilmLight Baselight	Linux						
Quantel Pablo PA	Windows					Windows	
Quantel Pablo Rio	Windows					Windows	
Red RedCine-X	Apple Windows			Apple Windows		Apple Windows	Apple Windows

[View Compatibility Chart](#)

Software Compatibility

KONA cards are cross-platform and compatible with a wide range of professional macOS®, Windows® and Linux® software applications.

AJA hardware is compatible with a wide range of professional software applications on macOS, Windows and Linux. AJA drivers and plug-ins create a seamless integration between the native software and AJA's high quality hardware that lets you focus on the work, not the technology.

View our software compatibility chart for the following categories:

Audio | Color | Dailies/Archiving | Editorial | Effects | Graphics/Virtual | Ingest/Playout | Restoration | SDI / IP Bridging | Streaming/Live Production Test/Measure | VJ / Live Video Performance | Video Assist



* For more information on the latest software compatibility please visit: www.aja.com/en/category/edit/compatibility

Features Comparison Chart

KONA capture cards are available in four models to meet your workflow needs, all built with AJA's reputation for quality, reliability and support.



KONA HDMI

KONA 1

KONA 4

KONA 3G

KONA LHi

KONA LHe Plus

SD (NTSC and PAL)	yes	yes	yes	yes	yes	yes
HD (720p, 1080i, 1080sf)	yes	yes	yes	yes	yes	yes
2K (2048 x 1556, 2048 x 1080) Dual Link HD, 2K HSDL, 4:4:4 RGB	yes	yes	yes	yes	video 2K x 1080 to 4:2:2, no-RGB	-
4K (3840 x 2160, 4096 x 2160) YCbCr and RGB color spaces	yes	-	yes	yes	-	-
4K HFR	yes	-	yes	-	-	-
3G-SDI	-	yes	yes	yes	yes	-
HDMI	1x HDMI 2.0 3x HDMI 1.4b (UltraHD 50/60p 8-bit 4:2:0)	-	HDMI 1.4b (UltraHD 50/60p 8-bit 4:2:0)	HDMI 1.4a output	HDMI 1.3a input/output	-
HD to SD Down-conversion (10-bit, in hardware)	-	-	yes	yes	yes	yes
SD to HD Up-conversion (10-bit, in hardware)	-	-	yes	yes	yes	-
HD to HD Cross-conversion (1080 to/ from 720, 10-bit, in hardware)	-	-	yes	yes	yes	-
12-bit Analog Video (component, composite, and Y/C)	-	-	output SD/HD	output SD/HD	input/output SD/HD	input/output SD/HD
10-bit SDI Digital Video (BNC)	-	input/output SD/HD/3G	4x 3G bidireccional	input/output SD/HD/3G	input/output SD/HD/3G	input/output SD/HD
HD Video+Key	yes	yes	yes	yes	-	-
Analog Audio (balanced XLR)	-	-	-	-	input/output 2-Channel	input/output 2-Channel
AES Digital Audio	-	-	8-Ch I/O w/cable, 16-Ch I/O w/K3G-Box	8-Ch I/O w/cable, 16-Ch I/O w/K3G-Box	input/output 2-Channel	input/output 2-Channel
Embedded SDI Audio (via BNC)	8 Ch input	16 Ch input/output	16 Ch input/output	16 Ch input/output	input/output 8-Channel	input/output 8-Channel
Professional Genlock	-	yes	yes	yes	yes	yes
LTC Input/Output	-	yes	yes	yes	LTC input (shared with reference BNC)	-
RS-422 Machine Control	-	yes	yes	yes	yes	yes
1RU Breakout Box (optional)	-	-	yes	yes	yes	yes
3 year AJA Warranty	yes, included	yes, included	yes, included	yes, included	yes, included	yes, included

KONA[®] HDMI



HDMI Capture for Multi-Channel HD or Single-Channel UltraHD

KONA HDMI is an 8-lane PCIe 2.0 card heralding a new paradigm for the AJA KONA product line. All of the quality, and flexibility you have come to expect from AJA is now available as a dedicated multi-channel HDMI capture card.

Designed for the demands of multiple workflows such as gaming, streaming, VJ-ing, live events switching, vlogging, VR, post and broadcast, this powerful card boasts support for single channel capture up to 4K/UltraHD 60p or four channel ingest and streaming up to 2K/HD 60p.

\$895 US MSRP*

[Find a Reseller](#)

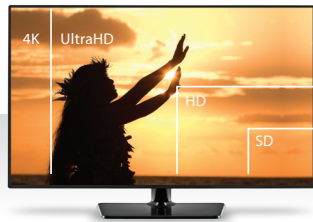

Powerful Flexibility

KONA HDMI provides four full size HDMI ports that can be used to switch, stream or capture up to four channels of 2K/HD p60 via HDMI 1.4b. with appropriate 3rd party software.

KONA HDMI can also be used to capture a single stream of 4K/UltraHD, 2K/HD or SD via HDMI 2.0.

With appropriate 3rd party software, KONA HDMI can also be used to ingest/switch up to four channels of 2K/HD p60 via HDMI 1.4b.



Integration

KONA HDMI is compatible with macOS[®], Windows[®] and Linux[®]. The power of KONA HDMI can be utilized for live streaming and events via Telestream Wirecast[®], vMix[®] and other 3rd party software.

For single channel capture, AJA Control Room[™] software provides the perfect way to create digital media for use in your editing or effects package of choice.

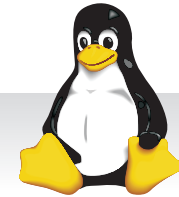

Flexible

3rd party developers can use the AJA SDK to create multichannel ingest, and switching solutions.

KONA HDMI also supports Video4Linux, allowing for both V4L2 development and compatibility with a wide range of off the shelf video capture utilities and software including, but not limited to; FFmpeg, GStreamer, MythTV, OpenCV, Skype, veejay, VLC media player and more

KONA HDMI Features Include:

- Four full size HDMI Inputs
- HDMI 2.0 and HDMI 1.4b
- Standard PCIe form factor
- Embedded HDMI audio in: Up to 8 per channel (for a total of 32 possible audio channels)
- Simultaneously ingest or switch up to Four 2K/HD 60p sources with appropriate 3rd party software*

- Ingest a single 4K/UltraHD 60p source on Port 1 using AJA Control Room
- Capture stunning HDR from Games and more
- AJA Retail* and SDK support
- Video4Linux support

*e.g. Telestream Wirecast support out of the box

**Bit depth support is application dependent. Check with your software manufacturer for compatibility.



KONA[®] HDMI

eSports Workflow, Multi-channel HD HDMI Capture

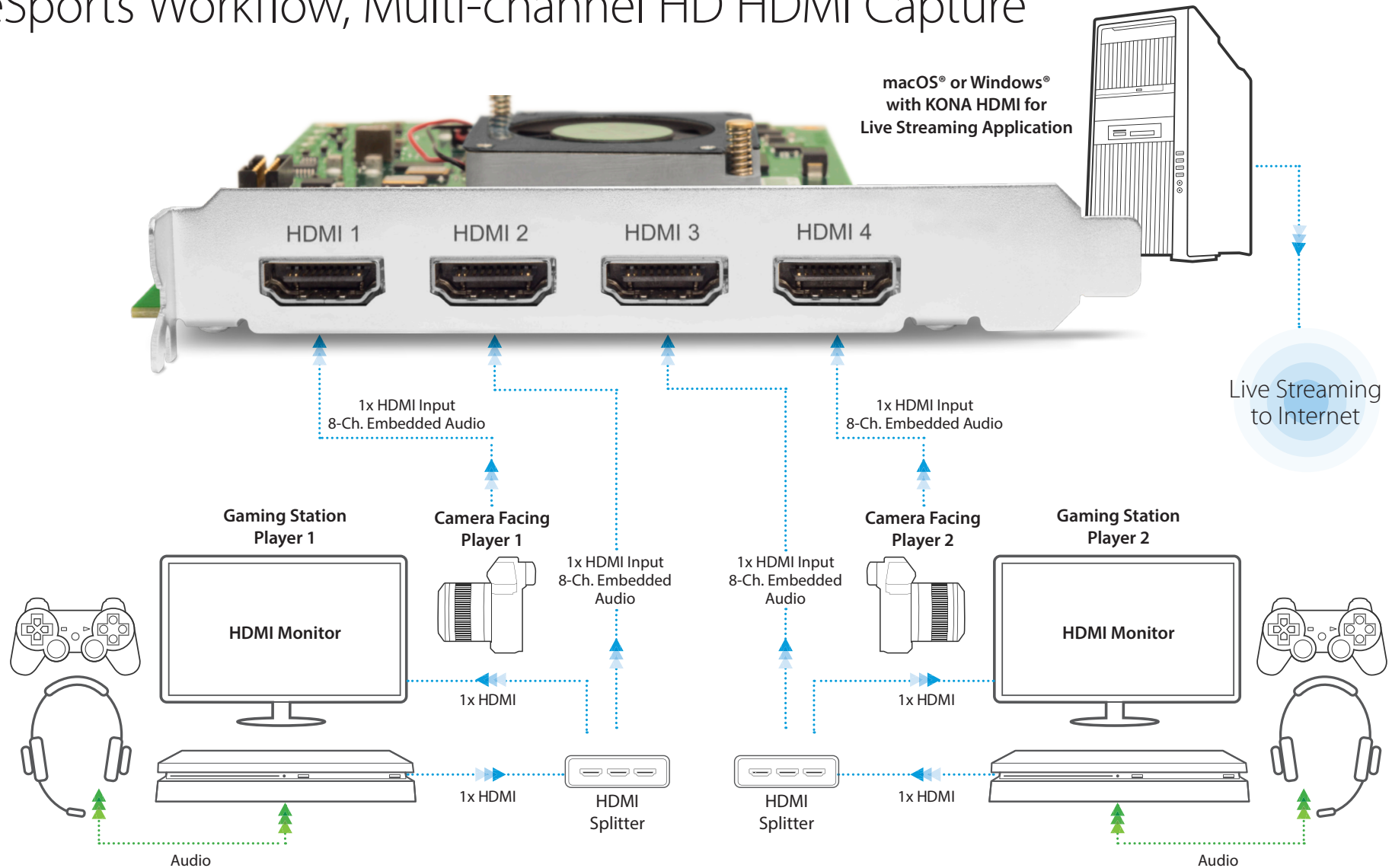

[Click here](#)

For full product specifications visit www.aja.com/en/products/kona-hdmi/#techspecs



KONA[®] HDMI

HDMI Capture for UltraHD

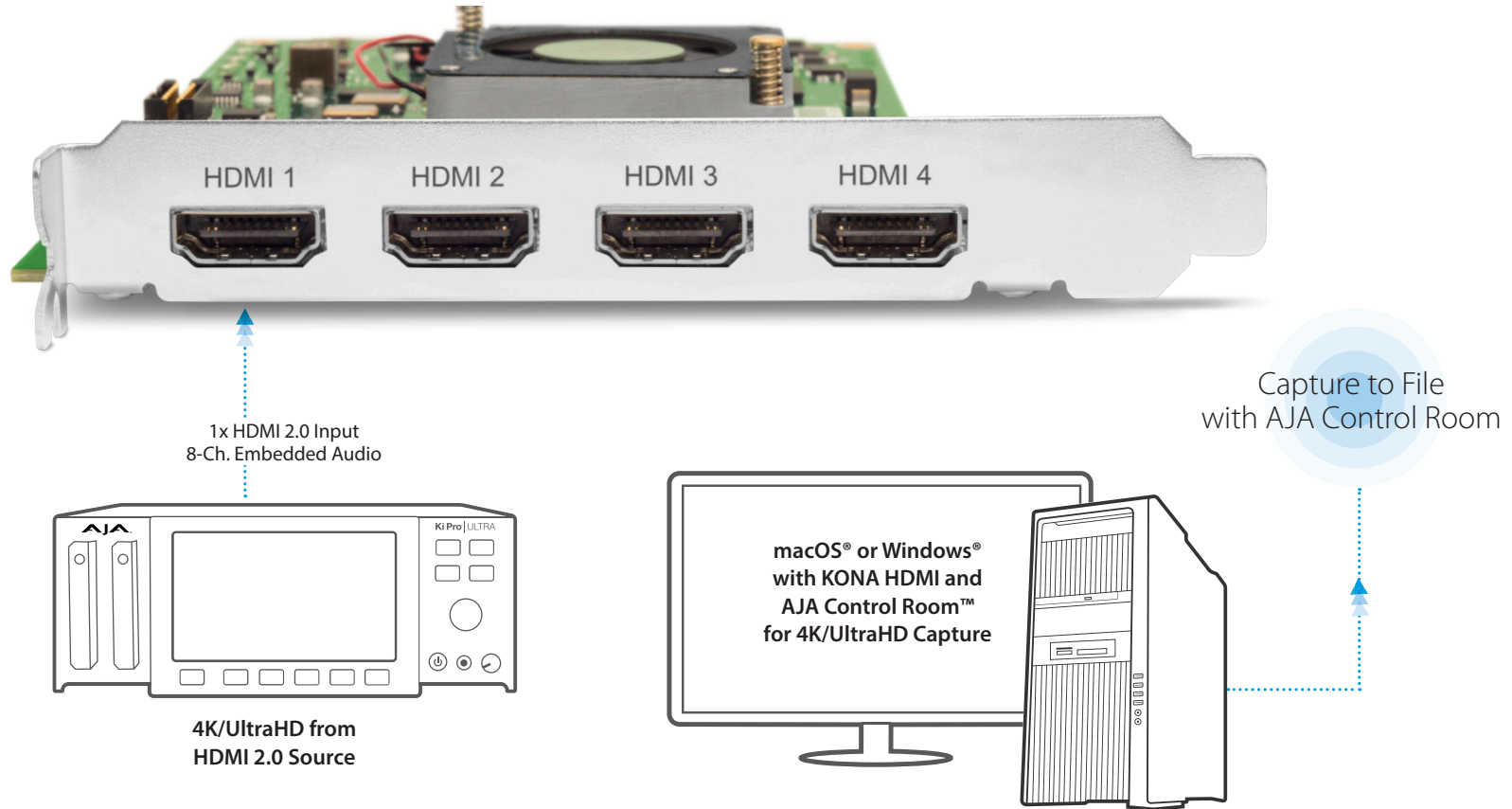

[Click here](#)

For full product specifications visit www.aja.com/en/products/kona-hdmi/#techspecs



KONA[®] HDMI

Tech Specs

Video formats

- (4K) 4096 x 2160P 23.98, 24, 25, 29.97, 30, 50, 59.94, 60
- (UltraHD) 3840 x 2160P 23.98, 24, 25, 29.97, 30, 50, 59.94, 60
- (2K) 2048 x 1080p 23.98, 24, 25, 29.97, 30, 50, 59.94, 60
- (2K) 2048 x 1080PsF 23.98, 24, 25
- (HD) 1080i 50, 59.94, 60
- (HD) 1080PsF 23.98, 24, 25, 29.97, 30
- (HD) 1080p 23.98, 24, 25, 29.97, 30, 50, 59.94, 60
- (HD) 720p 50, 59.94, 60
- (SD) 625i 50
- (SD) 525i 59.94

Video Input Digital

- Single stream 4K/UltraHD* with HFR support up to 60p, 4:2:2, 10-bit
 - 30/36 bits/pixel, RGB or YUV, 6 Gbps per color component
- Quad stream 2K/HD/SD** with HFR support up to 60p, 4:2:2, 10-bit
 - 30/36-bits/pixel, RGB or YUV, 2.25 Gbps

*Using AJA Control Room or appropriate third party switching/capture software

**Using appropriate third party switching/capture software

Audio Input Digital

- 8-Channel, 16 and 24-bit HDMI embedded audio, 48 kHz sample rate, synchronous per HDMI Input

- Single stream input supports up to 8-Channels
- Quad stream input supports up to 32-Channels

Size (w x d x h)

- 0.75" x 8.25" x 5.0" (19.05 x 209.55 x 127.00 mm)

Weight

- 0.3 lb (0.2 kg)

Power

- something

Environment

- Safe Operating Temperature: 0 to 40 C (32 to 104 F)
- Safe Storage Temperature (Power OFF): -40 to 60 C (-40 to 140 F)
- Operating Relative Humidity: 10-90% noncondensing
- Operating Altitude: <3,000 meters (<10,000 feet)

[Click here](#)

For full product specifications visit www.aja.com/en/products/kona-hdmi/#techspecs



KONA[®] 1

Powerful and Cost Effective 3G-SDI I/O

KONA 1 offers powerful 3G-SDI capture and playback with 16-Channels of embedded audio, LTC, and support for up to 2K/HD 60p.

Supported by free AJA Desktop Software with broad third party software compatibility on Mac and Windows, with a powerful SDK kit for cost effective OEM ingest and playback.

\$595 US MSRP*

[Find a Reseller](#)

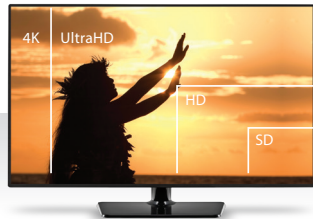

Streamlined Power

2K, HD or SD 3G-SDI I/O up to 50/60p via PCIe 2.0
Available as both a Retail ready-to-go solution for editing, color correction, VFX and more, or for developers utilizing the latest AJA SDK.



Compatibility

AJA Desktop Software with a powerful suite of integrated 3rd-party plugins for Adobe CC applications and Avid Media Composer on macOS and Windows simplifies NLE and VFX integration.

AJA Control Room on macOS, Windows or Linux simplifies capture and playout for a broad range of applications.



Professional Connectivity

KONA 1 offers professional connectivity with a dedicated 3G-SDI Input, dedicated 3G-SDI Output, 16-Ch. of embedded audio, dedicated Reference / LTC Input and deck or digital VTR Control via RS-422.

KONA 1 Features Include:

- 3G-SDI and 1.5G-SDI formats supported
- PCIe 2.0 form factor
- Embedded SDI audio in 16-Ch.
- Embedded SDI audio out 16-Ch.
- Color Space Conversion

- Genlock with reference input
- LTC input
- ANC capture and processing
- Retail and SDK support (Including AJA Control Panel Audio Mixer)
- RS-422 (for SDK developers there is also an option for low profile PCIe without external RS422 header)



KONA[®] 1

Streamlined Capture and Playback

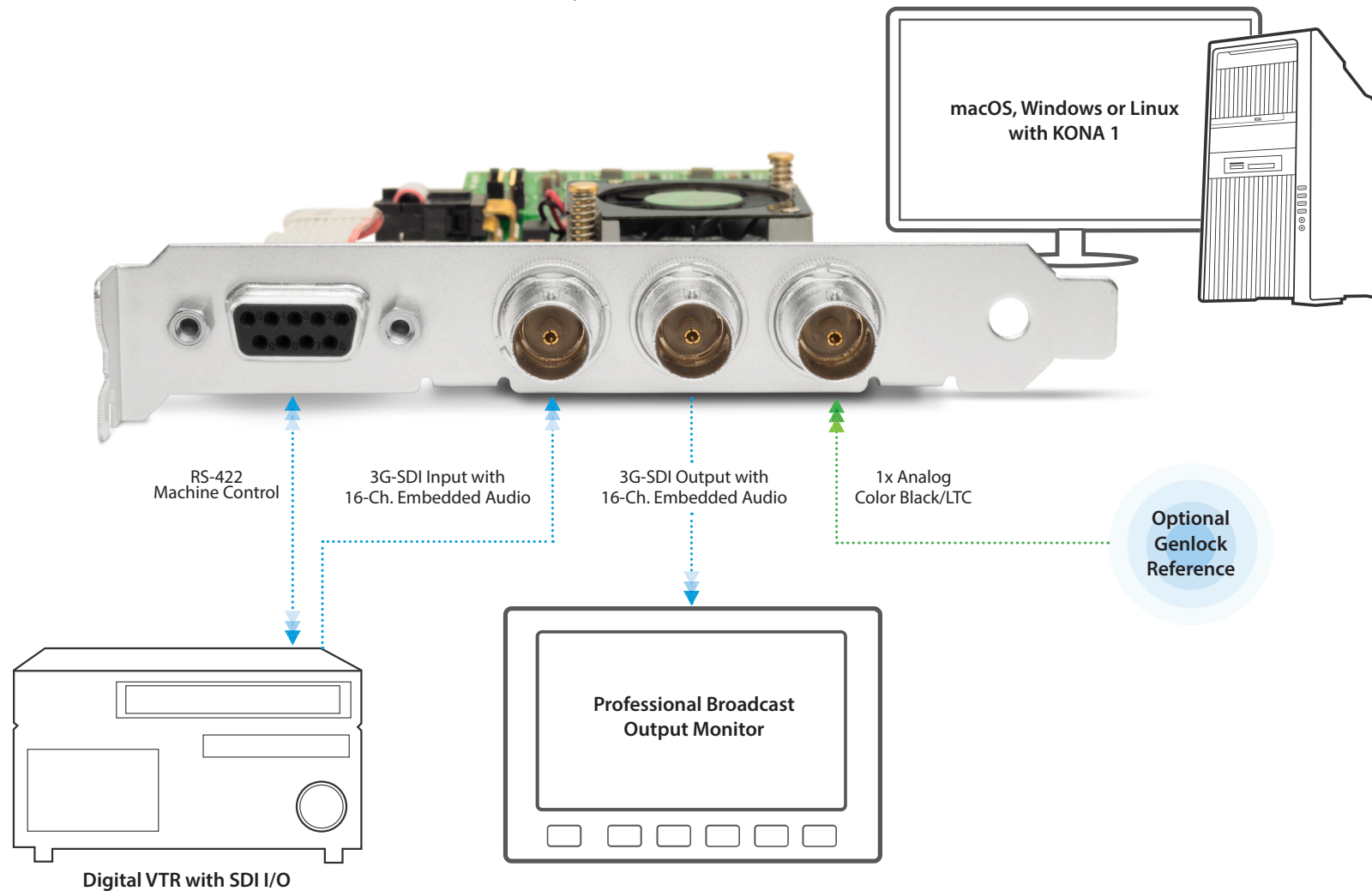

[Click here](#)

For full product specifications visit www.aja.com/en/products/kona-1/#techspecs



KONA[®] 1

Tech Specs

Video Formats

- (2K) 2048 x 1080p 23.98, 24, 25, 29.97, 30, 50, 59.94, 60
- (2K) 2048 x 1080PsF 23.98, 24, 25
- (HD) 1080i 50, 59.94, 60
- (HD) 1080PsF 23.98, 24, 25, 29.97, 30
- (HD) 1080p 23.98, 24, 25, 29.97, 30, 50, 59.94, 60
- (HD) 720p 50, 59.94, 60
- (SD) 625i 50
- (SD) 525i 59.94

Video Input Digital

- 3G-SDI, SMPTE-259/292/296/424

Video Output Digital

- 3G-SDI, SMPTE-259/292/296/424

Audio Input Digital

- 16-Channel 24-bit SDI embedded, 48 kHz synchronous

Audio Output Digital

- 16-Channel 24-bit SDI embedded, 48 kHz synchronous

Reference / LTC Input

- Analog Color Black or HD Tri-level sync
- LTC

Electrical Interface

- 2-lane PCIe 2.0

Machine Control

- RS-422, Sony 9-pin protocol
- 9-pin D-connector pinout is as follows:

1	GND	7	RX+
2	RX-	8	TX-
3	TX+	9	GND
4	GND	Shell	GND
5	No Connection		
6	GND		

Size (w x d x h)

- 0.55" x 6.61" x 2.16" (13.97 x 167.89 x 54.86 mm)

Weight

- 0.3 lb (0.3 kg)

Environment

- Safe Operating Temperature: 0 to 40 C (32 to 104 F)
- Safe Storage Temperature (Power OFF): -40 to 60 C (-40 to 140 F)
- Operating Relative Humidity: 10-90% noncondensing
- Operating Altitude: <3,000 meters (<10,000 feet)

[Click here](#)

For full product specifications visit www.aja.com/en/products/kona-1/#techspecs



KONA[®] 4



Powerful integration. Professional connectivity.

KONA 4 offers users a single, powerful 8-lane PCIe 2.0 video and audio desktop I/O card with unparalleled features for handling everything from 4K/UltraHD to 2K/HD to SD with full 10-bit 4:2:2 and 4:4:4 or 12-bit color spaces for fantastic image clarity, KONA 4 is a proven workhorse for broadcast and post, providing the tools you need to get the job done. Supporting HFR up to 4K 60p, with Deep Color, HDR 10, HLG and the AJA Audio Mixer for professional audio punch-in, KONA 4 has the power for the work you do today and into the future.

\$1,995 US MSRP*

[Find a Reseller](#)

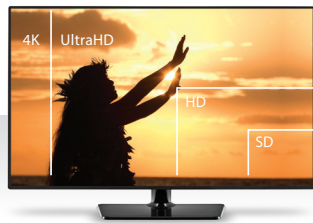

Powerful

With four bidirectional 3G-SDI spigots, KONA 4 provides you with the flexibility to take on the full spectrum of formats and win. Single link and dual link formats are available for 3G and 1.5G-SDI signals.

Plus, quad-link 3G-SDI provides the same effective bandwidth as 12G-SDI, meaning you can capture and deliver pristine, professional quality video up to 4K 60p. Monitor HDR over HDMI for the deepest color fidelity.



Integration

KONA 4's broadcast quality up, down, cross-converter unifies resolutions, simplifying workflows and eliminating the need to adjust resolution within software. The powerful hardware downstream keyer allows graphics and images to be overlaid on the video being input to the card.



Professional Connectivity

KONA 4 features bidirectional 3G-SDI connections that can be used for input and output. HDMI 1.4b monitoring output, LTC I/O, genlock input, RS-422 control, configurable 3 x BNC SD/HD analog video output and 8-Channel AES audio I/O allow KONA 4 to integrate into a variety of workflows.

KONA 4 Features Include:

- Supports 4K and UltraHD ingest and output at frame rates up to 50/60 fps
- Real-time up, down, cross-conversion with pristine 10-bit quality
- macOS, Windows and Linux support
- 10-bit 4K/UltraHD and 2K/Dual Link/HD/SD input and output
- 12-bit** color support (supported by some software vendors)
- HDMI 1.4b (UltraHD 50/60p 8-bit 4:2:0)

** Bit depth support is application dependent. Check with your software manufacturer for compatibility.

*** HLG support is application dependent. Check with your software manufacturer for compatibility

- HDR 10 Support - HDR Infoframe metadata, in accordance with HDMI 2.0a/CTA-861.3
- HLG (Hybrid Log Gamma) support***
- 8-Ch AES/EBU, 8-Ch embedded HDMI, and 16-Ch embedded SDI digital audio I/O
- Supports 444 and 422 workflows
- Extend external connectivity with K3G-BOX breakout box option



KONA[®] 4

Connections

K3G-BOX Breakout Box
(Optional)

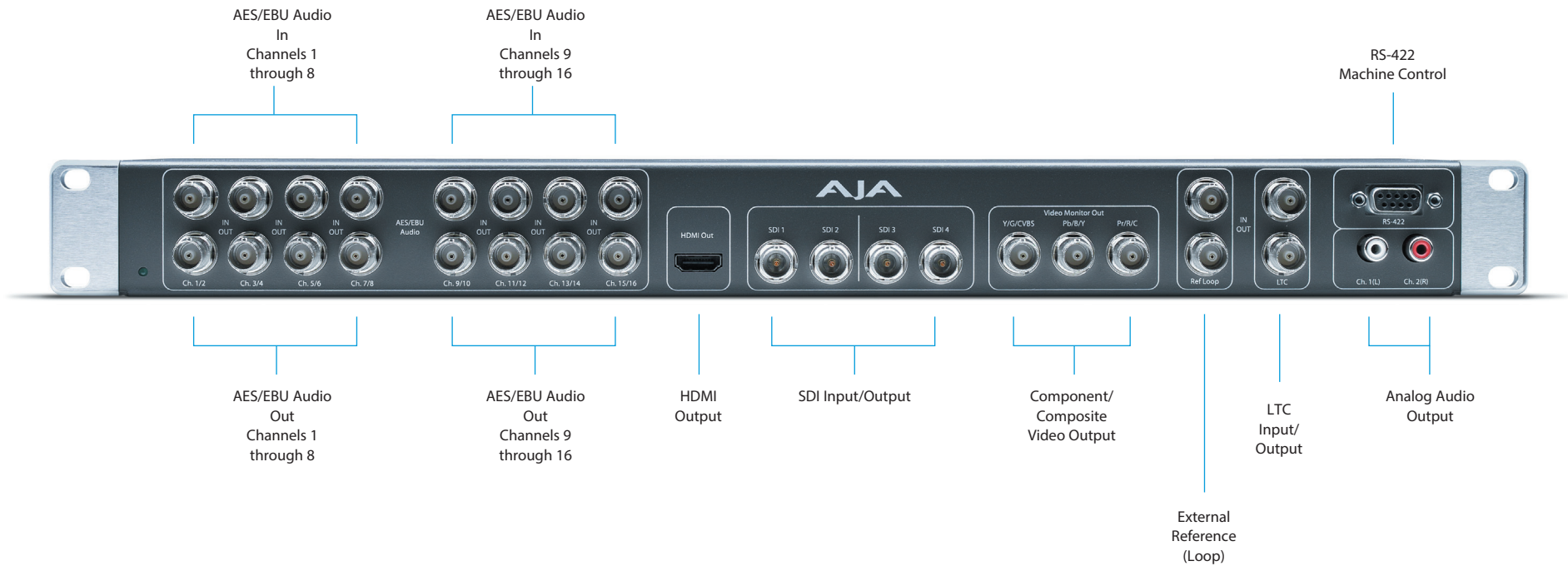

[Click here](#)

For full product specifications visit www.aja.com/en/products/kona-4/#techspecs



KONA[®] 4

Connections

Breakout Cables (Supplied)

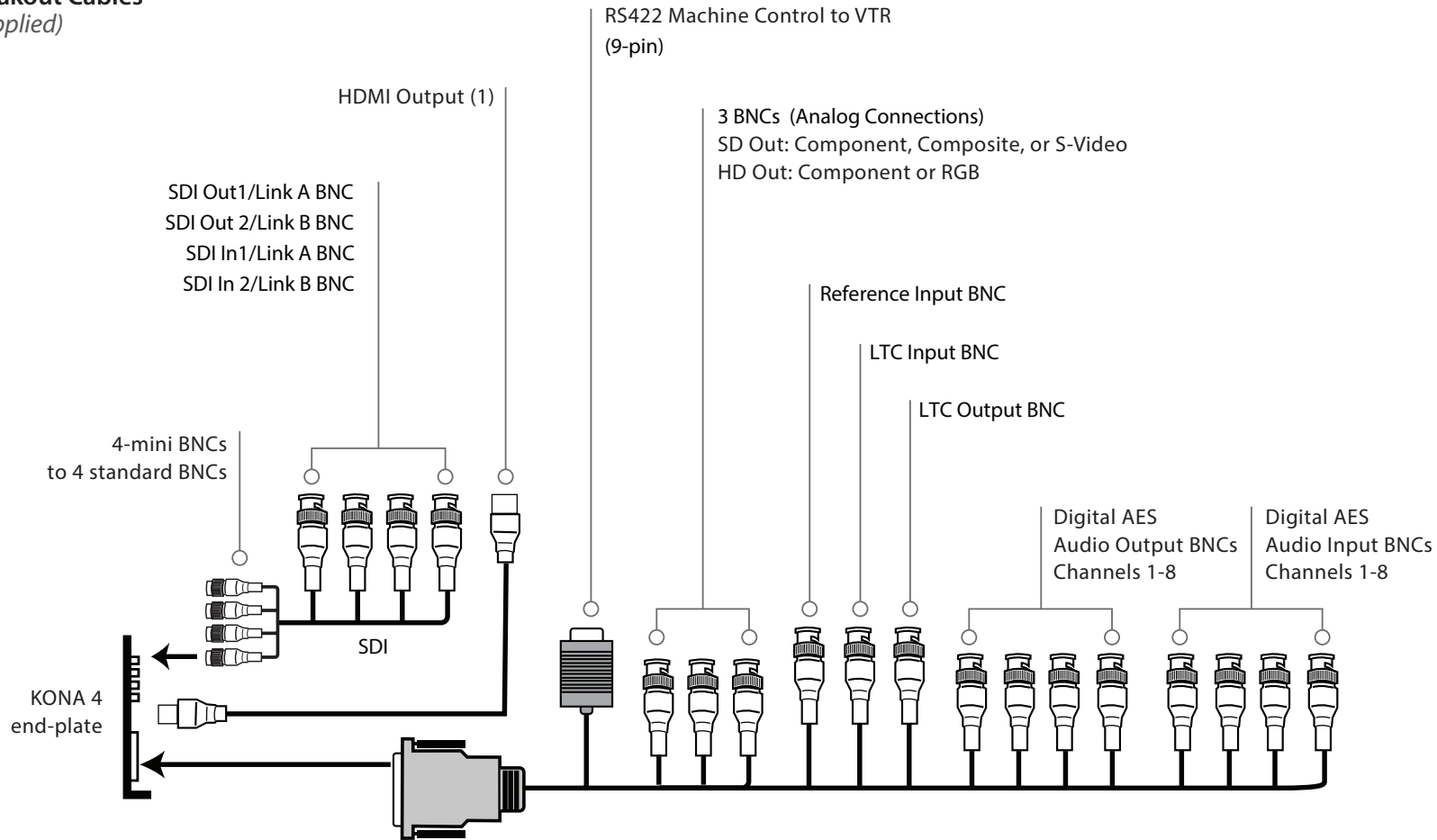

[Click here](#)

For full product specifications visit www.aja.com/en/products/kona-4/#techspecs

HDR



KONA[®] 4

Workflow

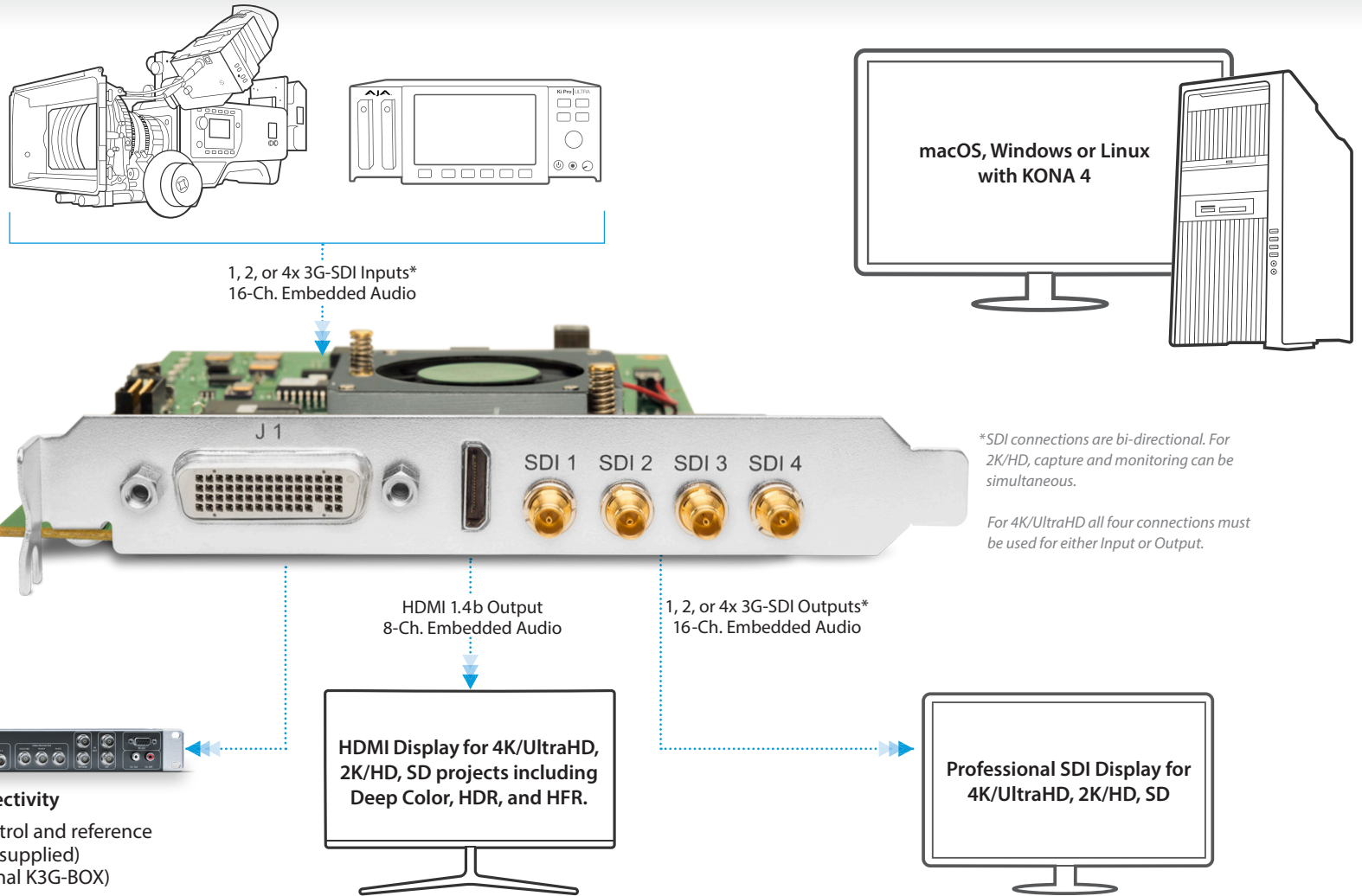

Connect your digital sources via 3G-SDI to KONA for capture and editing via a wide variety of formats. Monitor HDR using HDMI and master through high quality professional SDI and Component outputs.

[Click here](#)

For full product specifications visit www.aja.com/en/products/kona-4/#techspecs

HDR



KONA[®] 4

Tech Specs

Video Formats

- (4K) 4096 x 2160p 23.98, 24, 25, 50, 59.94, 60
- (UltraHD) 3840 x 2160p 23.98, 24, 25, 29.97, 50, 59.94, 60
- (2K) 2048 x 1556p 15, 14.98
- (2K) 2048 x 1556PsF 15, 23.98, 24
- (2K) 2048 x 1080p 23.98, 24, 25, 29.97, 30, 50, 59.94, 60
- (2K) 2048 x 1080PsF 23.98, 24, 25
- (HD) 1080i 50, 59.94, 60
- (HD) 1080PsF 23.98, 24, 25, 29.97, 30
- (HD) 1080p 23.98, 24, 25, 29.97, 30, 50, 59.94, 60
- (HD) 720p 23.98*, 24*, 25*, 29.97*, 30*, 50, 59.94, 60
- (SD) 625i 50
- (SD) 525i 23.98*, 59.94

**These formats are dependent on specific software functionality and are not normal over the wire formats.*

Video Input Digital

- 3G-SDI, SMPTE-259/292/296/424/425, 8-bit, 10-bit and 12-bit*
- 4K/UltraHD 4:2:2 and 4:4:4 up to 50/60 fps
- 2K HSDL (High Speed Data Link) 4:4:4, (2x BNC)
- Dual Link HD 4:4:4 (2x BNC)
- Single Link 4:2:2 or 4:4:4 (1x BNC)
- 1D LUT support

**Bit depth support is application dependent. Check with your software manufacturer for compatibility.*

Video Output Digital

- 3G-SDI, SMPTE-259/292/296/424, 8-bit, 10-bit and 12-bit*
- 4K/UltraHD 4:2:2 and 4:4:4 up to 50/60 fps
- 2K HSDL (High Speed Data Link) 4:4:4, (2x BNC)
- Dual Link HD 4:4:4, (2x BNC)
- Single Link 4:2:2 or 4:4:4 (1x BNC)
- HDMI v1.4b
 - 30/36-bits/pixel, RGB or YUV, 2.25 Gbps
 - 2K, HD, and SD, UltraHD with HFR support up to 60p 4:2:0
 - HDR10 Support - HDR Infoframe metadata, in accordance with HDMI 2.0a/CTA-861.3
 - HLG Support - in accordance with HDMI 2.0b/CTA-861-G**

**Bit depth support is application dependent. Check with your software manufacturer for compatibility.*

***HLG support is application dependent. Check with your software manufacturer for compatibility.*

Video Output Analog

- Composite/S-Video (Y/C) (1x BNC/2 x BNC+adapter)
- NTSC, NTSCJ, PAL
- Component (3x BNC)
- HD: YPbPr, RGB
- SD: YPbPr, RGB (component mode)
- SMPTE/EBU N10, Betacam 525 line, Betacam 525J, RGB
- 12-bit D/A, 8x oversampling
- +/- .2 dB to 5.0 MHz Y frequency response
- +/- .2 dB to 1 MHz C frequency response
- 5% 2T pulse response
- <1% Diff Phase
- <1% Diff Gain
- <1% ns Y/C delay inequity

Audio Input Digital

- 16-Channel, 16 and 24-bit SDI embedded audio, 48 kHz sample rate, synchronous
- 16-Channel, 16 and 24-bit AES/EBU audio, 48 kHz sample rate, synchronous (via 8x BNC on optional K3G-Box)
- 8-Channel, 16 and 24-bit AES/EBU audio, 48 kHz sample rate, synchronous or nonsynchronous, internal sample rate conversion (via 4x BNC on breakout cable)

Audio Output Digital

- 16-Channel, 16 and 24-bit SDI embedded audio, 48 kHz sample rate, synchronous
- 16-Channel, 16 and 24-bit AES/EBU audio, 48 kHz sample rate, synchronous (via 8x BNC on optional K3G-Box)
- 8-Channel, 16 and 24-bit HDMI embedded audio, 48 kHz sample rate, synchronous
- 8-Channel, 16 and 24-bit AES/EBU audio, 48 kHz sample rate, synchronous or nonsynchronous, internal sample rate conversion (via 4x BNC on breakout cable)

Downstream Keyer

- Supports graphics with alpha channel over video, matte or framebuffer, or framebuffer content over incoming video or matte

SD to SD Aspect Ratio Conversion

- Letterbox: This transforms SD anamorphic material to a letterboxed image
- H Crop: Will produce a horizontally stretched effect on the image; transforms anamorphic SD to full frame
- SD Pillarbox: Will produce an image in the center of the screen with black borders on the left and right sides and an anamorphized image in the center
- V Crop: Will transform SD letterbox material to an anamorphic image

Timecode

- LTC timecode input and output (via 1x BNC each)

Reference Input

- Analog color black (1V) or composite sync (2 or 4V)
- Looping
- 75 ohms on optional K3G-Box, terminated on supplied breakout cable

Electrical Interface

- 8-lane PCIe 2.0

Machine Control

- RS-422, Sony 9-pin protocol (via breakout cable or optional K3G-Box)
- 9-pin D-connector pinout is as follows:

1	GND	7	RX+
2	RX-	8	TX-
3	TX+	9	GND
4	GND	Shell	GND
5	No Connection		
6	GND		

Size (w x d x h)

- 0.75" x 6.9" x 5.0" (19.05 x 175.26 x 127.00 mm)

Weight

- 0.7 lb (0.4 kg)

Power

- 22W typical, 24W maximum

Environment

- Safe Operating Temperature: 0 to 40 C (32 to 104 F)
- Safe Storage Temperature (Power OFF): -40 to 60 C (-40 to 140 F)
- Operating Relative Humidity: 10-90% noncondensing
- Operating Altitude: <3,000 meters (<10,000 feet)

[Click here](#)

For full product specifications visit www.aja.com/en/products/kona-4/#techspecs

HDR



KONA® 3G

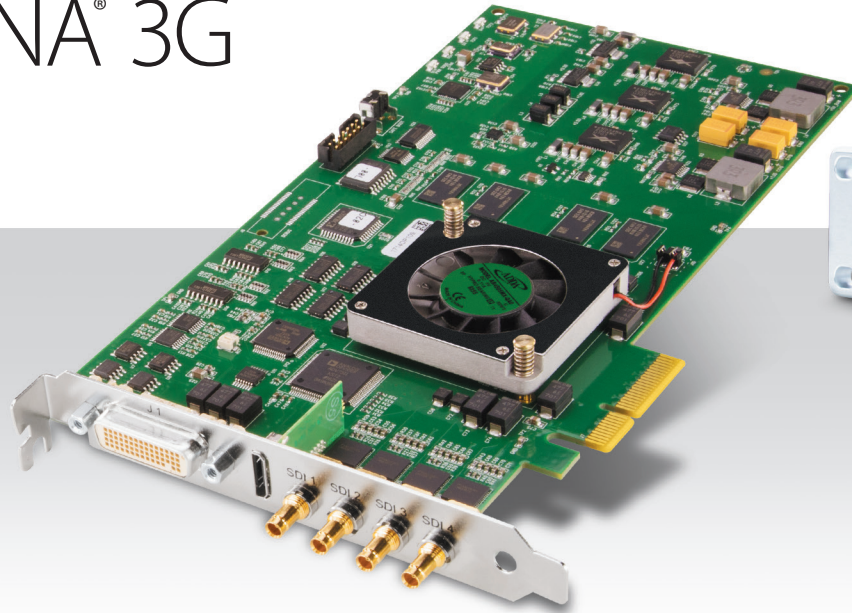

\$1,995 US MSRP*

[Find a Reseller](#)

Ready for today's workflows and those of the future, KONA 3G gives video professionals unrivaled features and the highest standards in quality and performance.

Professional Performance

Robust capabilities and reliable quality for 4K/UltraHD/2K/HD/SD 10-bit desktop I/O.

KONA 3G is a video and audio desktop I/O card that provides video professionals with unparalleled features for handling everything from SD to HD, 2K and 4K with full 10-bit uncompressed clarity. With a broadcast quality up, down, cross-converter and the ability to work in 3D, KONA 3G has the power for the work you do today and into the future.

KONA 3G offers users a single, powerful card with support for 4:2:2 and 4:4:4 color spaces to provide the highest quality for your images. The futureproof architecture means you can easily work with HD and 2K now and switch to working at 4K resolution when the need arises, even at frame rates up to 60 fps, without the requirement for new hardware. KONA 3G supports Dual Link 4:4:4 HD-SDI, with full bandwidth 4:4:4 RGB at 10-bits for 1080i, 1080p, 1080PsF and 720p formats. KONA 3G can also convert between 4:4:4 and 4:2:2 formats for single link HD-SDI monitoring and output.

For SDI video, KONA 3G features two 3G/HD/SD inputs and two outputs. HDMI 1.4a monitoring output, LTC I/O, genlock input and

configurable 3 x BNC SD/HD analog video output. Switch KONA 3G into 4K mode and all four BNC connections can be used for 4K capture or output.

KONA 3G's 4K support allows output directly from editing systems to 4K projectors or monitors, including HFR support at 50/60 fps and 4K HDMI output to support the latest UltraHD monitors, allowing editors and clients to view full resolution 4K images as they work. This output capability enables a powerful 4K workflow that is also affordable and manageable.

The built-in up, down, cross-converter brings any video to a unified resolution, simplifying workflows and eliminating the need to adjust resolution within software. KONA 3G also includes a powerful hardware downstream keyer that can place graphic files with an alpha channel, selectable color matte or the contents of the card's frame buffer over the video being input to the card.

KONA[®] 3G

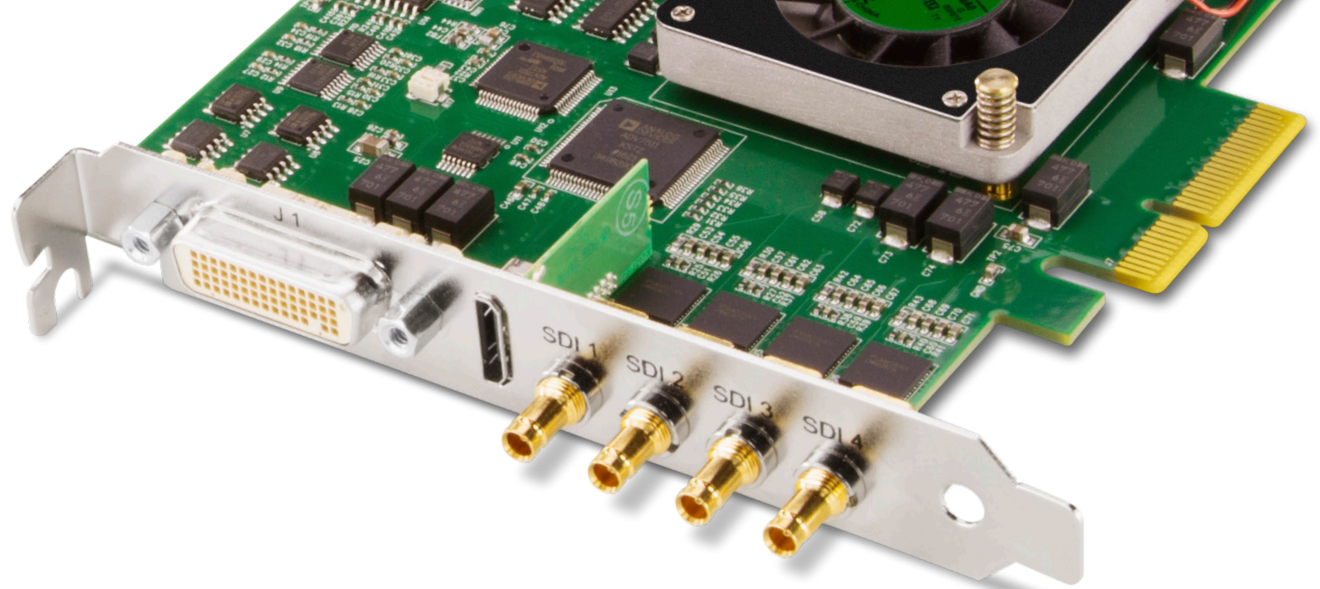

From SD to 4K in a Single Card

KONA 3G is futureproof, allowing you to easily work in HD and 2K and switch to working at 4K/UltraHD resolutions without the need for additional or new hardware.

Leading the way for quality 4K capture, monitoring and output, KONA 3G offers 4K in both YCbCr and RGB. When 4K mode is selected, the four SDI connectors are remapped as I/O for handling the four quadrants of a 4K picture, providing support for most standard 4K formats.



Integrated AJA Hardware Conversion

KONA 3G features full 10-bit, broadcast quality, motion adaptive SD to HD up-conversion, HD to HD cross-conversion, HD to SD down-conversion, and automatic SD/HD 12-bit component analog output.

Since all conversion functionality on the KONA 3G is hardware based, it's available on ingest or playback.

Uniquely, the KONA 3G can cross-convert 720p 23.98 to 1080PsF 23.98. Cross-conversion is particularly valuable in today's multiformat HD post environment where producing pristine 720p or 1080i signals at will helps streamline dailies and deliverables.



Extend your Connectivity

The optional K3G-Box breakout box and cables allow KONA 3G to integrate easily into rack environments, enabling quick access to all video and audio connections without having to get at the back of the tower computer. Additional K3G-Box functionality over the standard breakout cable comes in the form of eight additional AES audio channels, 2-Channel RCA analog audio monitoring jacks, and looping BNC genlock reference connectors.



KONA[®] 3G

Connections

K3G-BOX Breakout Box
(Optional)

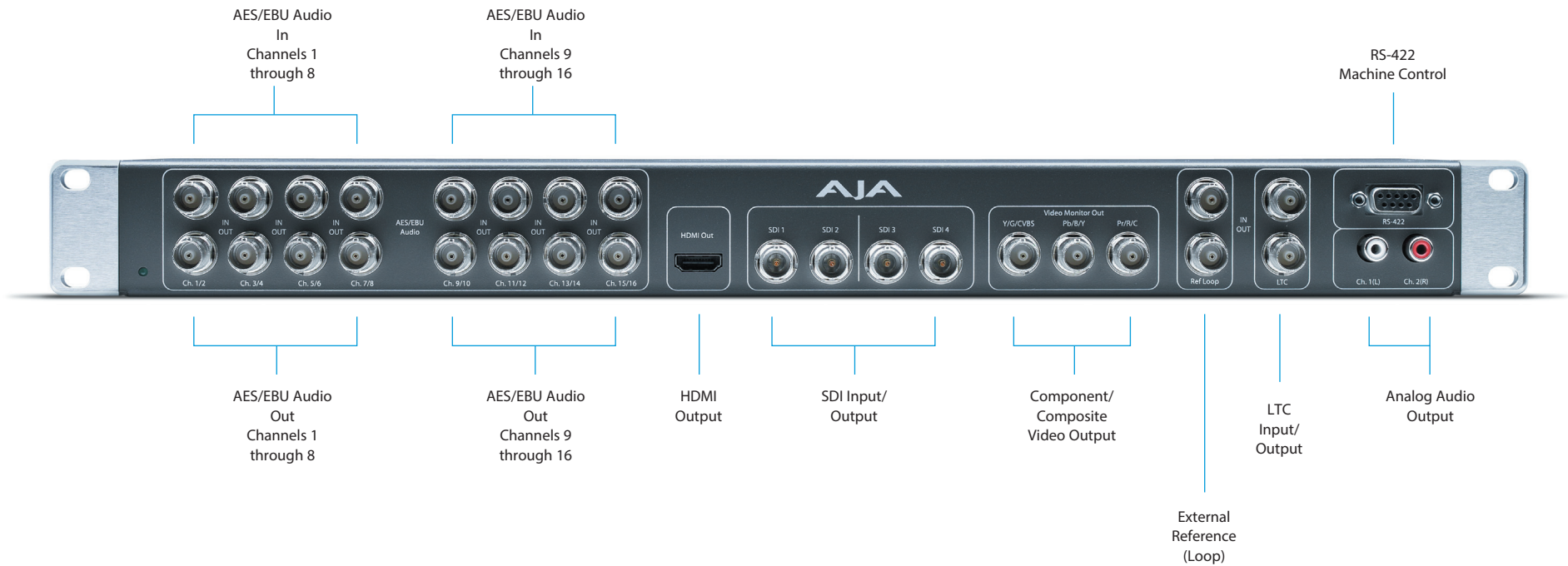

[Click here](#)

For full product specifications visit www.aja.com/en/products/kona/#techspecs



KONA® 3G

Connections

Breakout Cables (Supplied)

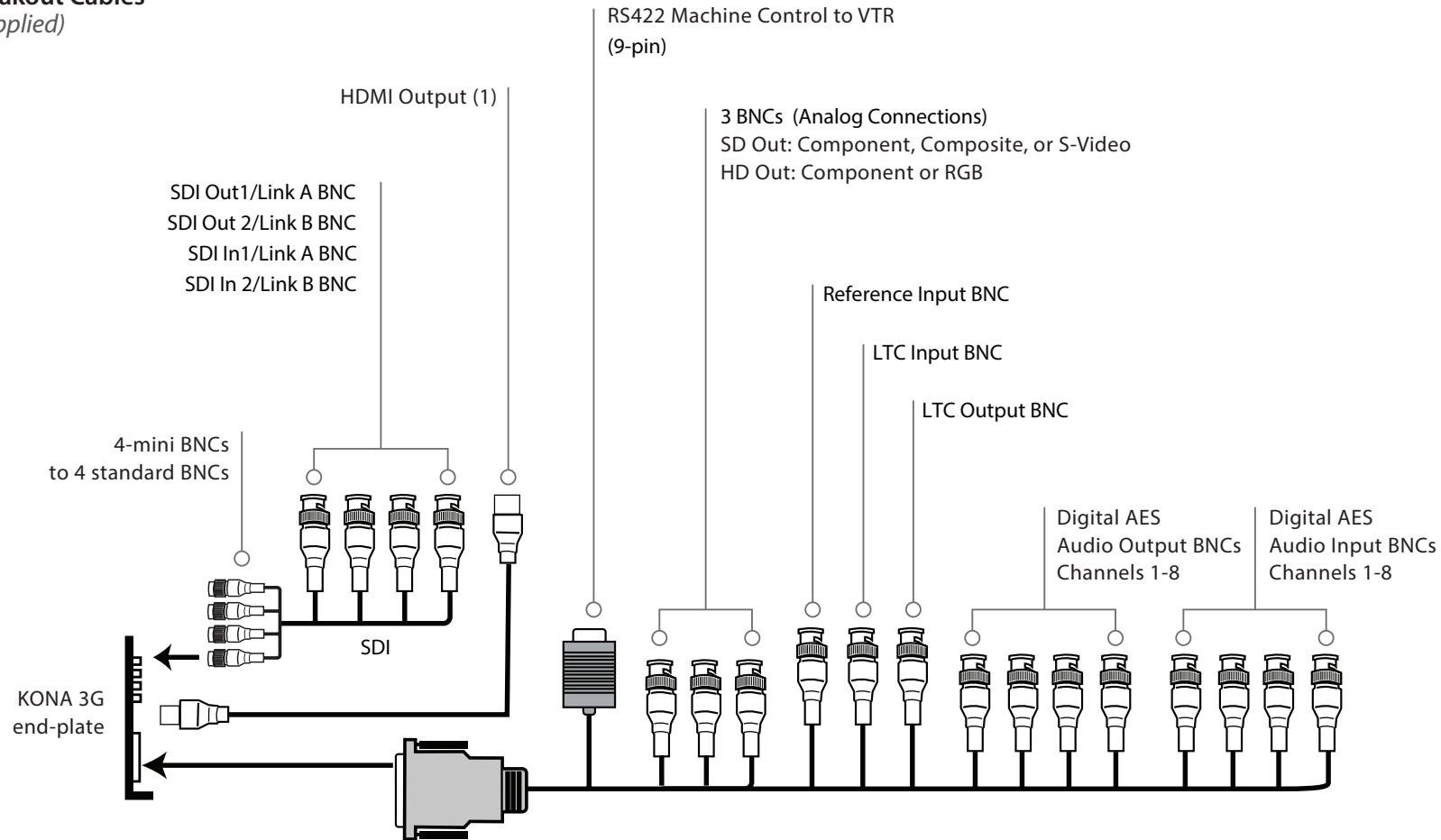

[Click here](#)

For full product specifications visit www.aja.com/en/products/kona-3g/#techspecs



KONA[®] 3G

Workflow

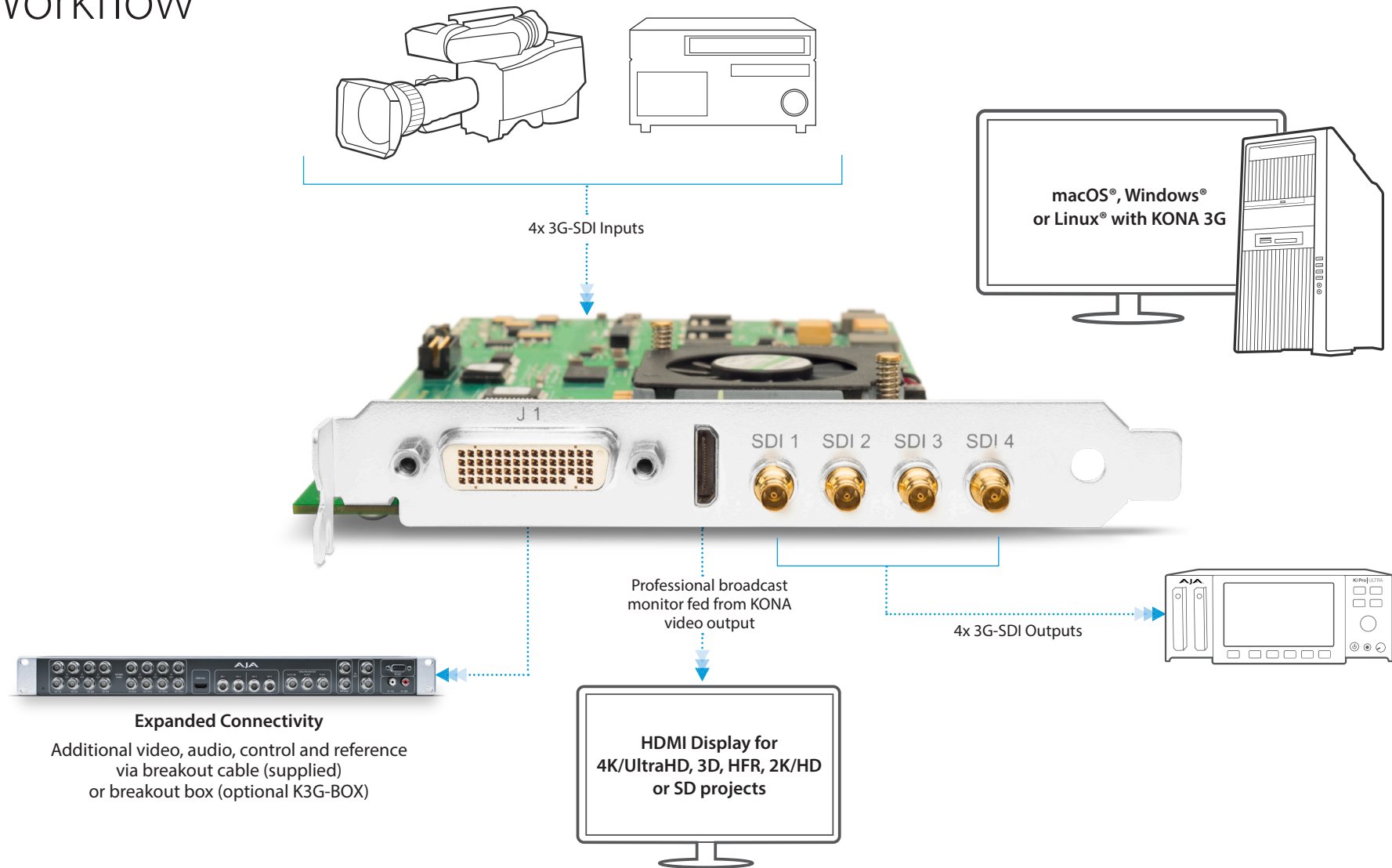

KONA® 3G

Tech Specs

Video Formats

- (4K) 4096 x 2160p 23.98, 24, 25, 29.97, 30
- (UltraHD) 3840 x 2160p 23.98, 24, 25, 29.97, 30
- (2K) 2048 x 1080p 23.98, 24, 25, 29.97, 30, 50 and 60
- (2K) 2048 x 1080PsF 23.98, 24, 25
- (2K) 2048 x 1556p 15, 14.98
- (2K) 2048 x 1556PsF 15, 23.98, 24
- (HD) 1080i 50, 59.94, 60
- (HD) 1080PsF 23.98, 24, 25, 29.97, 30
- (HD) 1080p 23.98, 24, 25, 29.97, 30, 50, 59.94, 60
- (HD) 720p 23.98*, 24*, 25*, 29.97*, 30*, 50, 59.94, 60
- (SD) 625i 50
- (SD) 525i 23.98*, 59.94

*These formats are dependent on specific software functionality and are not normal over the wire formats.

Video Input Digital

- 4K/UltraHD 422 and 444 (4x BNC)
- 2K HSDL (High Speed Data Link) 4:4:4, (2x BNC)
- 3G/SD/HD SDI, SMPTE-259/292/296/424, 8 or 10-bits
- Dual Link HD 4:4:4 (2x BNC)
- Single Link 4:2:2 or 4:4:4 (1x BNC)
- 1D LUT Support

Video Output Digital

- 4K/UltraHD 422 and 444 (4x BNC)
- 2K HSDL (High Speed Data Link) 4:4:4, (2x BNC)
- 3G/SD/HD SDI, SMPTE-259/292/296/424
- Dual Link HD 4:4:4, (2x BNC)
- Single Link 4:2:2 or 4:4:4 (1x BNC)
- HDMI v1.4, 30/36-bits/pixel, RGB or YUV, 2.25Gbps, SD, HD, 1080p-50/60 (1x mini-HDMI)

Video Output Analog

- Composite/S-Video (Y/C) (1x BNC/2x BNC+Adapter)
- NTSC, NTSCJ, PAL
- Component (3x BNC)
- HD: YPbPr, RGB
- SD: YPbPr, RGB (component mode)
- SMPTE/EBU N10, Betacam 525 line, Betacam 525J, RGB

- 12-bit D/A, 8x oversampling
- +/- .2 dB to 5.0 MHz Y frequency response
- +/- .2 dB to 1 MHz C frequency response
- .5% 2T pulse response
- <1% Diff Phase
- <1% Diff Gain
- <1 ns Y/C delay inequity

Audio Input Digital

- 16-Channel, 16 and 24-bit SMPTE-259 SDI embedded audio, 48 kHz sample rate, synchronous
- 16-Channel, 16 and 24-bit AES/EBU audio, 48 kHz sample rate, synchronous (via 8x BNC on optional K3G-Box)
- 8-Channel, 16 and 24-bit AES/EBU audio, 48 kHz sample rate, synchronous or nonsynchronous, internal sample rate conversion (via 4x BNC on breakout cable)

Audio Output Digital

- 16-Channel, 16 and 24-bit SMPTE-259 SDI embedded audio, 48 kHz sample rate, synchronous
- 16-Channel, 16 and 24-bit AES/EBU audio, 48 kHz sample rate, synchronous (via 8x BNC on optional K3G-Box)
- 8-Channel, 16 and 24-bit HDMI embedded audio, 48 kHz sample rate, synchronous
- 8-Channel, 16 and 24-bit AES/EBU audio, 48 kHz sample rate, synchronous or nonsynchronous, internal sample rate conversion (via 4x BNC on breakout cable)

Audio Output Analog

- 2-Channel unbalanced output (via 2x RCA jacks on optional K3G-Box)

Downstream Keyer

- Supports graphics with alpha channel over video, matte or framebuffer, or framebuffer content over incoming video or matte

Up-Conversion

- Hardware 10-bit

- Anamorphic: fullscreen
- Pillarbox 4:3: results in a 4:3 image in center of screen with black sidebars
- Zoom 14:9: results in a 4:3 image zoomed slightly to fill a 14:9 image with black side bars
- Zoom Letterbox: results in image zoomed to fill fullscreen
- Zoom Wide: results in a combination of zoom and horizontal stretch to fill a 16:9 screen; this setting can introduce a small aspect ratio change

Down-Conversion

- Hardware 10-bit
- Anamorphic: fullscreen
- Letterbox: image is reduced with black top and bottom added to image area with the aspect ratio preserved
- Crop: image is cropped to fit new screen size

Cross-Conversion

- Hardware 10-bit
- 1080i to 720p
- 720p to 1080i
- 720p to 1080PsF

SD to SD aspect ratio conversion

- Letterbox: This transforms SD anamorphic material to a letterboxed image
- H Crop: Will produce a horizontally stretched effect on the image; transforms anamorphic SD to full frame
- SD Pillarbox: Will produce an image in the center of the screen with black borders on the left and right sides and an anamorphized image in the center
- V Crop: Will transform SD letterbox material to an anamorphic image

Timecode

- LTC timecode input and output (via 1x BNC each)

Reference Input

- Analog Color Black (1V) or Composite Sync (2 or 4V)

- Looping
- 75 ohm on optional K3G-Box, terminated on supplied breakout cable

Electrical Interface

- 4-lane PCIe 2.0

Machine Control

- RS-422, Sony 9-pin protocol (via breakout cable or optional K3G-Box)
- 9-pin D-connector pinout is as follows:

1	GND
2	RX-
3	TX+
4	GND
5	No Connection
6	GND
7	RX+
8	TX-
9	GND
Shell	GND

Size (w x d x h)

- 0.75" x 8.25" x 5.0" (19.05 x 209.55 x 127.00 mm)

Weight

- 0.7 lb (0.4 kg)

Power

- 19W typical, 21W maximum

Environment

- Safe Operating Temperature: 0 to 40 C (32 to 104 F)
- Safe Storage Temperature (Power OFF): -40 to 60 C (-40 to 140 F)
- Operating Relative Humidity: 10-90% noncondensing
- Operating Altitude: <3,000 meters (<10,000 feet)

[Click here](#)

For full product specifications visit www.aja.com/en/products/kona-3g/#techspecs



KONA® LHi

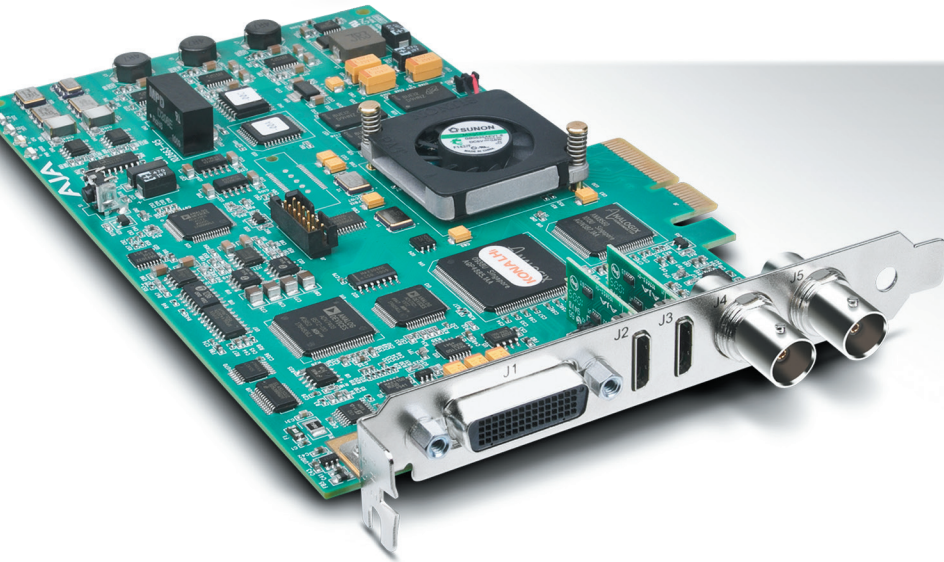

Only \$1,495 US MSRP*

[Find a Reseller](#)

The most flexible card for analog and digital standard and high definition workflows.



Utilize the KLHi-BOX Breakout Box to easily integrate KONA LHi into rackmount environments.

Multi-Format Analog and Digital I/O

KONA LHi provides the maximum compatibility for diverse workflows.

If your postproduction facility works with a wide variety of formats, frame rates and audio/video sources, the KONA LHi provides the connectivity you need, bridging the gap between analog devices and the latest 3G SDI and HDMI enabled products to provide editing, monitoring and mastering of professional quality video in an affordable, powerful, easy to use product.

Connecting to everything from an HDMI enabled camera to an HD-SDI VTR, KONA LHi offers a full host of no compromise features, including 10-bit or 8-bit uncompressed video, 2-Channel AES digital audio and 8-Channel SDI embedded digital audio, analog composite or S-video or SD/HD component video I/O, 2-Channel balanced analog audio I/O, and broadcast quality hardware based up, down, cross-conversion for flexible SD and HD post production. KONA LHi supports a full HDMI workflow with 10-bit deep color output for the best image quality possible. HDMI signals can also be converted to SDI for use in more professional environments.

KONA LHi features full 10-bit, broadcast quality, motion adaptive SD to HD up-conversion, HD to HD cross-conversion, HD to SD down-conversion, and automatic HD/SD 12-bit component analog output. Since KONA LHi's conversions are hardware based, they are available all the time - during ingest or playback. Outputs can be configured independently allowing you to have simultaneous HD and SD output - or two different types of HD: 720 or 1080 - output at the same time via cross-conversion.

In addition to a full set of video and audio I/O, KONA LHi can lock to external reference signals, accept timecode in and out and control a variety of tape decks via the industry standard RS-422 9-pin connection.



KONA® LHi

Multi-format Analog and Digital I/O

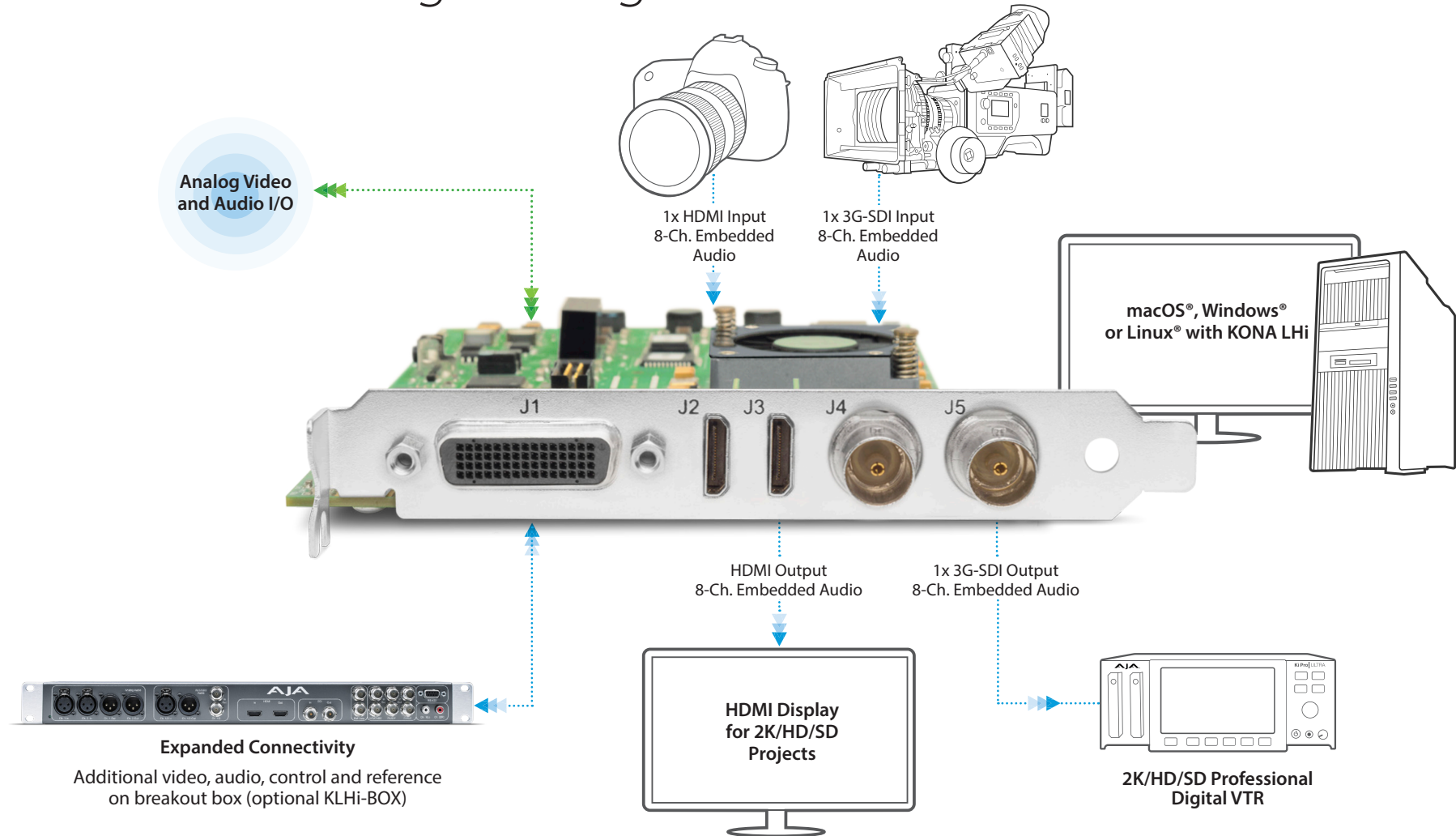

Connect your digital sources via HD/SD-SDI or HDMI to KONA for capture and editing via a wide variety of formats. Master to any digital or analog device through high quality professional SDI, HDMI or component outputs.



KONA[®] LHi

Connections

KLHI-BOX Breakout Box
(Optional)



[Click here](#)

For full product specifications visit www.aja.com/en/products/kona-lhi/#techspecs



Connections

Breakout Cables (Supplied)

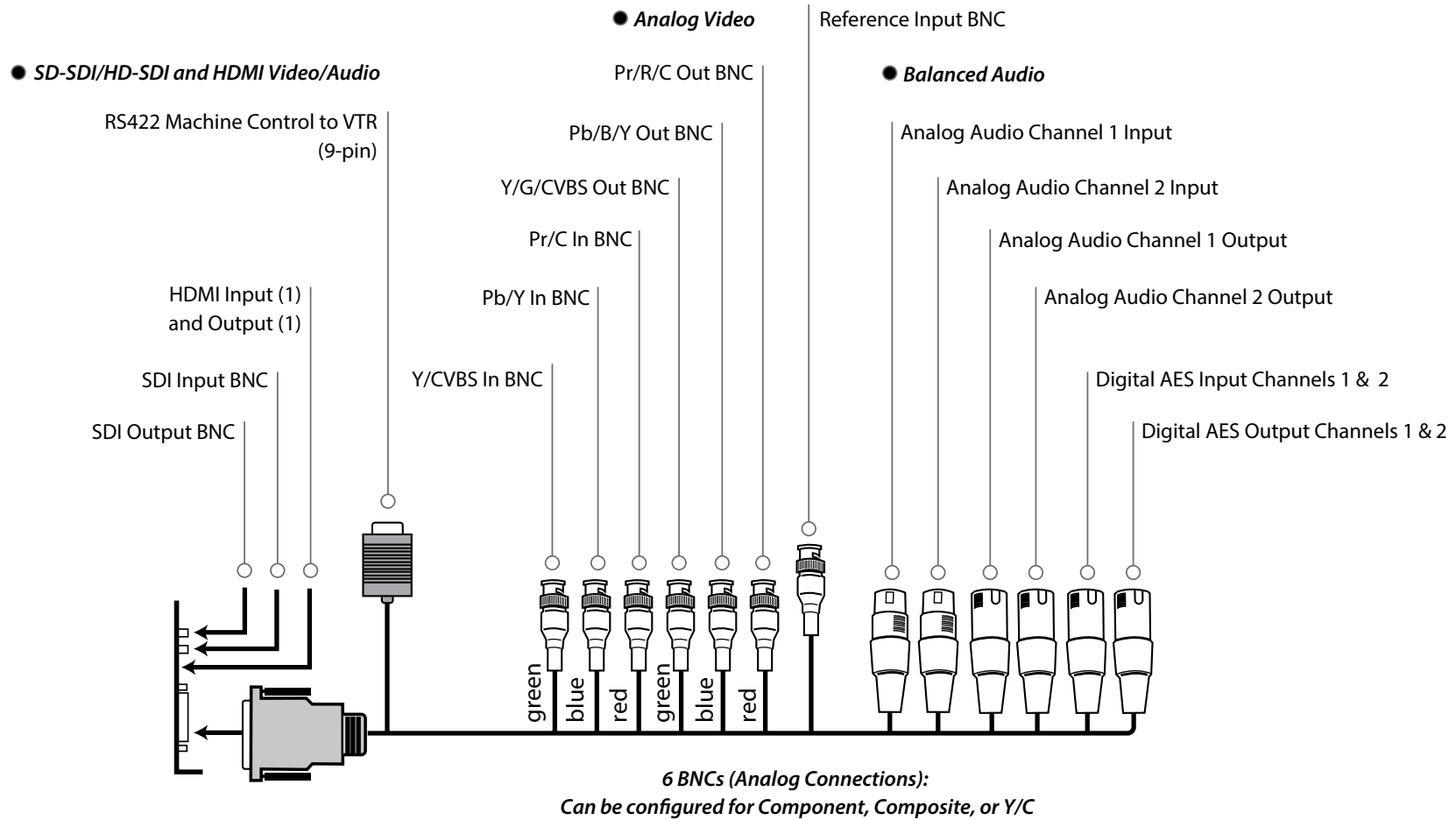

[Click here](#)

For full product specifications visit www.aja.com/en/products/kona-lhi/#techspecs



Tech Specs

Video Formats

- (2K) 2048 x 1080p 23.98, 24, 25, 29.97, 30
- (2K) 2048 x 1080PsF 23.98, 24
- (HD) 1080i 50, 59.94, 60
- (HD) 1080PsF 23.98, 24
- (HD) 1080p 23.98, 24, 25, 29.97, 30, 50, 59.94, 60
- (HD) 720p 50, 59.94, 60
- (SD) 625i 50
- (SD) 525i 59.94

Software Dependent Formats

- 720p 23.98
- 525i 23.98

Note: These formats are dependent on specific software functionality and are not normal over the wire formats.

Video Input Digital

- 3G/SD/HD SDI, SMPTE-259/292/296/424, 8 or 10-bits
- Single Link 4:2:2 (1x BNC)
- HDMI v1.3 30-bits/pixel, RGB or YUV, 2.25 Gbps, SD, HD, 1080p 50/60 (1x mini-HDMI)

Video Input Analog

- Composite/S-Video (Y/C) (1x BNC/2x BNC+Adapter)
- NTSC, NTSCJ, PAL
- Component (3x BNC)
- HD: YPbPr, RGB
- SD: YPbPr, RGB (component mode)
- SMPTE/EBU N10, Betacam 525 line, Betacam 525J, RGB
- 12-bit D/A, 8x oversampling
- +/- .2 dB to 5.0 MHz Y Frequency Response
- +/- .2 dB to 1 MHz C Frequency Response
- .5% 2T pulse response
- <1% Diff Phase
- <1% Diff Gain
- <1 ns Y/C delay inequity

Video Output Digital

- 3G/SD/HD SDI, SMPTE-259/292/296/424
- Single Link 4:2:2 or 4:4:4 (1x BNC)
- HDMI v1.3 30-bits/pixel, RGB or YUV, 2.25 Gbps, SD, HD, 1080p 50/60 (1x mini-HDMI)

Video Output Analog

- Composite/S-Video (Y/C) (1x BNC/2x BNC+Adapter)
- NTSC, NTSCJ, PAL
- Component (3x BNC)
- HD: YPbPr, RGB
- SD: YPbPr, RGB (component mode)
- SMPTE/EBU N10, Betacam 525 line, Betacam 525J, RGB
- 12-bit D/A, 8x oversampling
- +/- .2 dB to 5.0 MHz Y frequency response
- +/- .2 dB to 1 MHz C frequency response
- .5% 2T pulse response
- <1% Diff Phase
- <1% Diff Gain
- <1 ns Y/C delay inequity

Audio Input Digital

- 8-Channel, 16 and 24-bit SMPTE-259 SDI embedded audio, 48 kHz sample rate, synchronous
- 8-Channel, 16 and 24-bit HDMI embedded audio, 48 kHz sample rate, synchronous
- 2-Channel, 16 and 24-bit AES/EBU audio, 48 kHz sample rate, synchronous or nonsynchronous, internal sample rate conversion (via 1x XLR on breakout cable or optional KLHi-Box)

Audio Input Analog

- 2-Channel, 16 and 24-bit A/D analog audio, 48 kHz sample rate, balanced (via 2x XLR on DB-25 breakout cable or optional KLHi-Box)
- +24 dBu full scale digital
- +/- 0.2 dB 20 Hz to 20 kHz frequency response

Audio Output Digital

- 8-Channel, 16 and 24-bit SMPTE-259 SDI embedded audio, 48 kHz sample rate, synchronous
- 8-Channel, 16 and 24-bit HDMI embedded audio, 48 kHz sample rate, synchronous
- 2-Channel, 16 and 24-bit AES/EBU audio, 48 kHz sample rate, synchronous or nonsynchronous, internal sample rate conversion (via 1x XLR on breakout cable or optional KLHi-Box)

Audio Output Analog

- 2-Channel, 16 and 24-bit D/A analog audio, 48 kHz sample rate, balanced (via 2x XLR on DB-25 breakout cable or optional KLHi-Box)
- +24 dBu full scale digital (0 dBFS)
- +/- 0.2 dB 20 Hz to 20 kHz frequency response
- 2-Channel unbalanced output (via 2x RCA jacks on optional KLHi-Box)

Up-Conversion

- Hardware 10-bit
- Anamorphic: fullscreen
- Pillarbox 4:3: results in a 4:3 image in center of screen with black sidebars
- Zoom 14:9: results in a 4:3 image zoomed slightly to fill a 14:9 image with black side bars
- Zoom Letterbox: results in image zoomed to fill fullscreen
- Zoom Wide: results in a combination of zoom and horizontal stretch to fill a 16:9 screen; this setting can introduce a small aspect ratio change

Down-Conversion

- Hardware 10-bit
- Anamorphic: fullscreen
- Letterbox: image is reduced with black top and bottom added to image area with the aspect ratio preserved
- Crop: image is cropped to fit new screen size

Cross-Conversion

- Hardware 10-bit
- 1080i to 720p
- 720p to 1080i
- 720p to 1080PsF

SD to SD aspect ratio conversion

- Letterbox: This transforms SD anamorphic material to a letterboxed image
- H Crop: Will produce a horizontally stretched effect on the image; transforms anamorphic SD to full frame
- SD Pillarbox: Will produce an image in the center of the screen with black borders on the left and right sides and an anamorphized image in the center
- V Crop: Will transform SD letterbox material to an anamorphic image

Reference Input

- Analog Color Black (1V) or Composite Sync (2 or 4V)
- Looping
- 75 ohm on optional KLHi-Box, terminated on supplied breakout cable

Electrical Interface

- 4-lane PCIe 1.0

Machine Control

- RS-422, Sony 9-pin protocol (via DB-25 breakout cable or optional KLHi-Box)
- 9-pin D-connector pinout is as follows:

1	GND	7	RX+
2	RX-	8	TX-
3	TX+	9	GND
4	GND	Shell	GND
5	No Connection		
6	GND		

[Click here](#)

For full product specifications visit www.aja.com/en/products/kona-lhi/#techspecs



KONA[®] LHi

Tech Specs *(continued)*

Size (w x d x h)

- 0.75" x 8.25" x 5.0" (19.05 x 209.55 x 127.00 mm)

Weight

- 0.7 lb (0.4 kg)

Power

- 13W typical, 15W maximum

Environment

- Safe Operating Temperature: 0 to 40 C (32 to 104 F)
- Safe Storage Temperature (Power OFF): -40 to 60 C (-40 to 140 F)
- Operating Relative Humidity: 10-90% noncondensing
- Operating Altitude: <3,000 meters (<10,000 feet)

[Click here](#)

For full product specifications visit www.aja.com/en/products/kona-lhi/#techspecs



KONA® LHe Plus

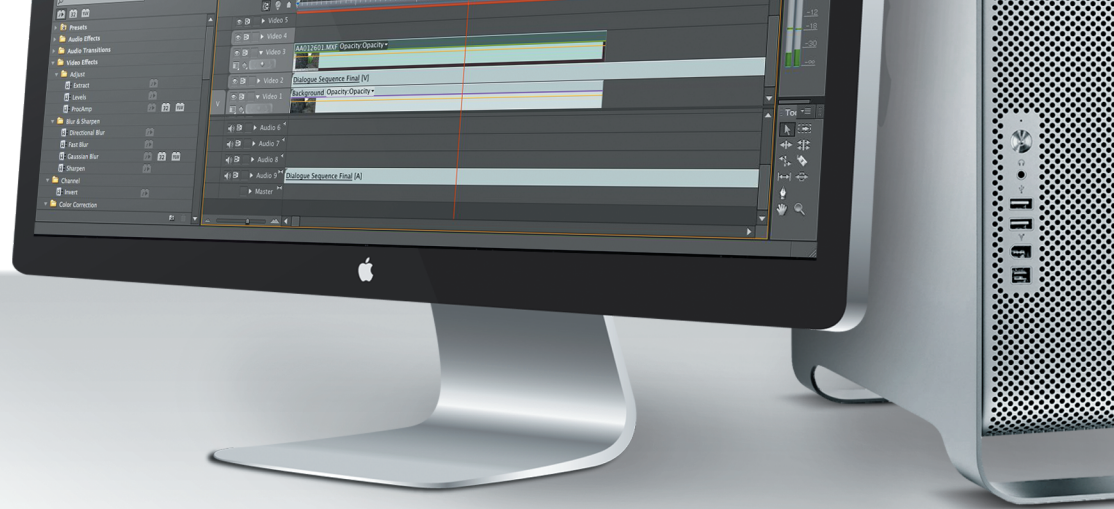
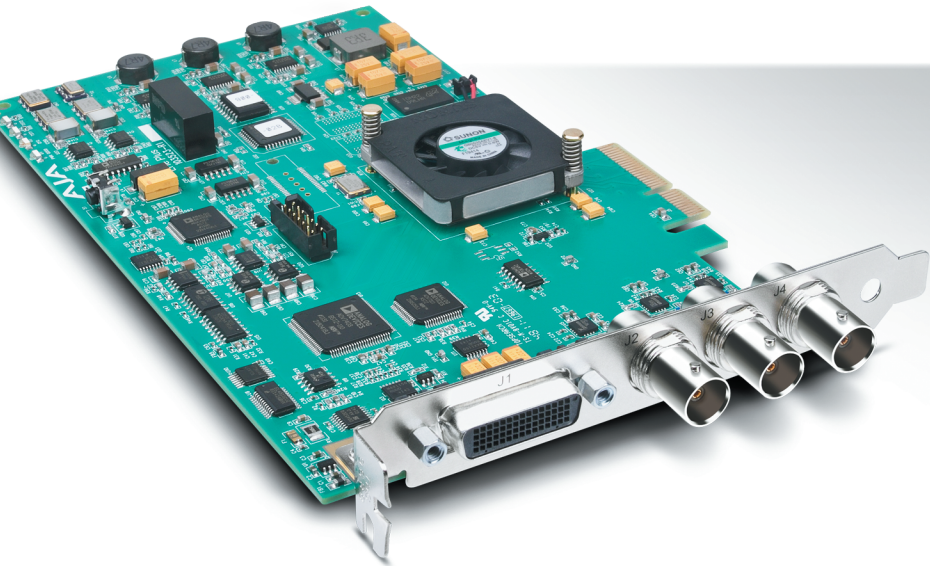

\$995 US MSRP*

[Find a Reseller](#)

Powerful video and audio I/O with a full set of no compromise features for video professionals.



Utilize the KL-BOX-LH breakout box to easily integrate KONA LHe Plus into rackmount environments.

Affordable, Flexible KONA Power

Add the power of AJA's KONA I/O to your system for high quality capture and output that fits within any budget.

KONA LHe Plus offers video professionals at all levels an affordable desktop I/O solution that doesn't compromise on quality or essential functionality and features.

KONA LHe Plus supports both SD/HD analog and digital I/O for video and audio, providing maximum capability in a single card, simplifying integrating analog and digital signals into a single workflow and provides multiple output options to ensure you can deliver whatever formats are required.

For SDI video, the KONA LHe Plus features one input and two outputs and can be configured independently for HD or SD. It offers genlock input, and three BNCs which may be configured for analog video input and output (HD or SD). Also included is a 9-pin connector for RS-422 machine control. Because the KONA LHe Plus supports 12-bit analog component HD input and output, devices with analog HD output, such as decks and even game consoles, can be connected for a variety of workflows.

The broadcast quality down-converter in the KONA LHe Plus allows it to connect to analog SD devices for output. This can be used to check framing and color for SD versions while still working in full resolution HD within your application, ensuring proper quality for multi-format deliveries. Since conversion is hardware based, it's available during ingest or playback.

Like all KONA cards, KONA LHe Plus connectivity can be extended via the KL-Box-LH breakout box, enabling simple integration into rack environments, with quick access to all video and audio connections and additional AES/EBU audio connectivity without having to access the back of the computer tower.



KONA[®] LHe Plus

Connections

KL-BOX-LH Breakout Box
(Optional)

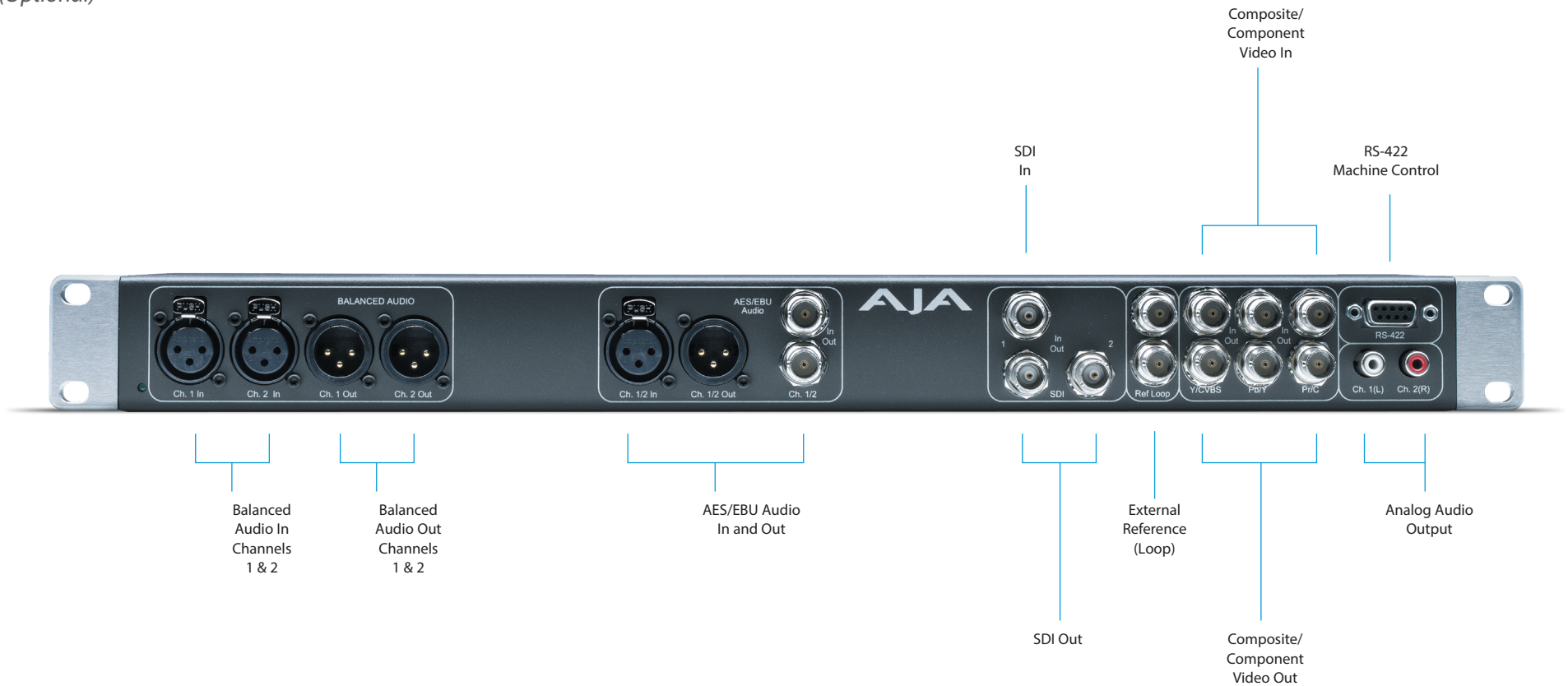

[Click here](#)

For full product specifications visit www.aja.com/en/products/kona-lhe-plus/#techspecs



KONA[®] LHe Plus

Connections

Breakout Cables (Supplied)

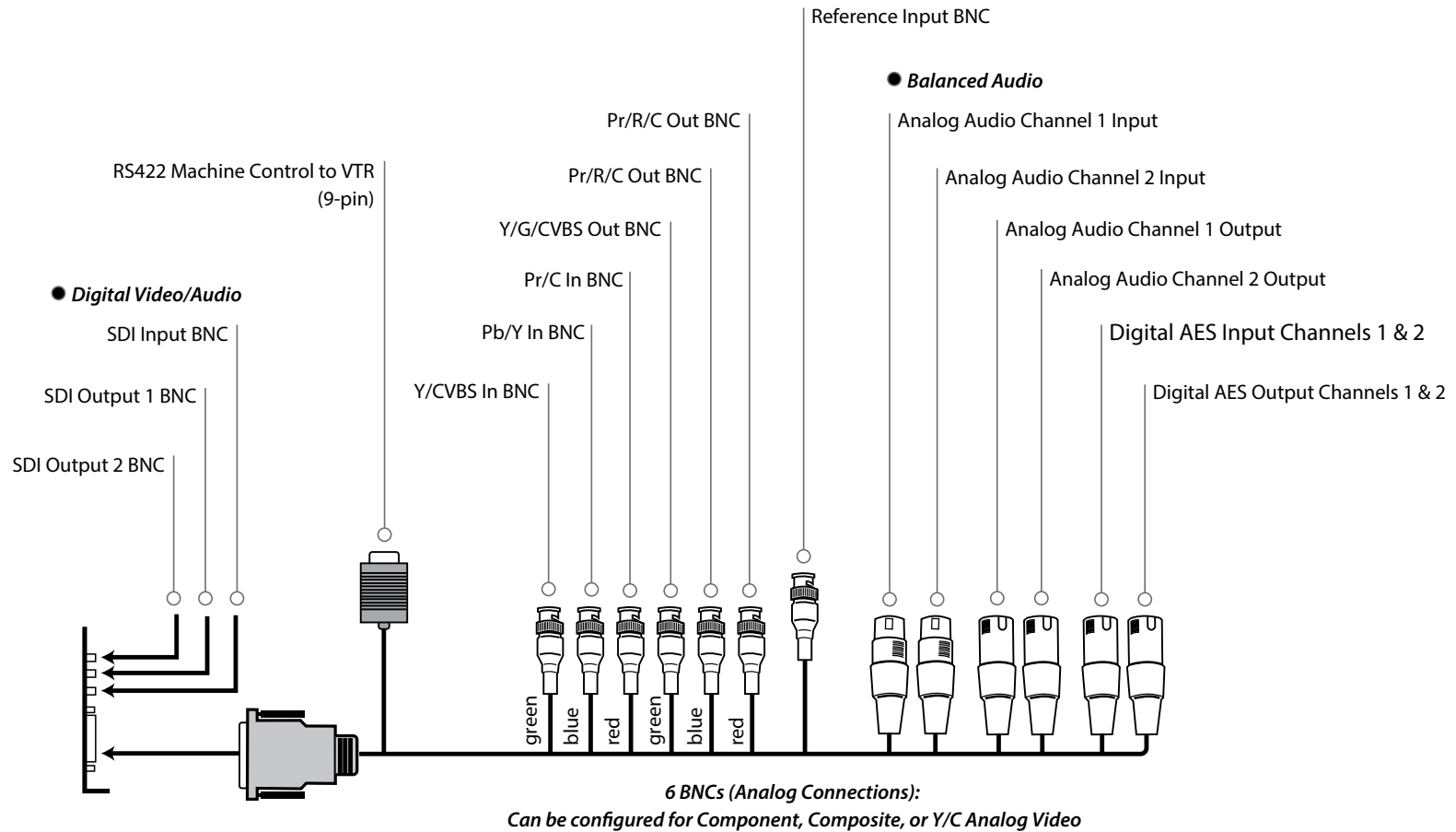

[Click here](#)

For full product specifications visit www.aja.com/en/products/kona-lhe-plus/#techspecs



KONA[®] LHe Plus

Multi-format Analog and Digital I/O

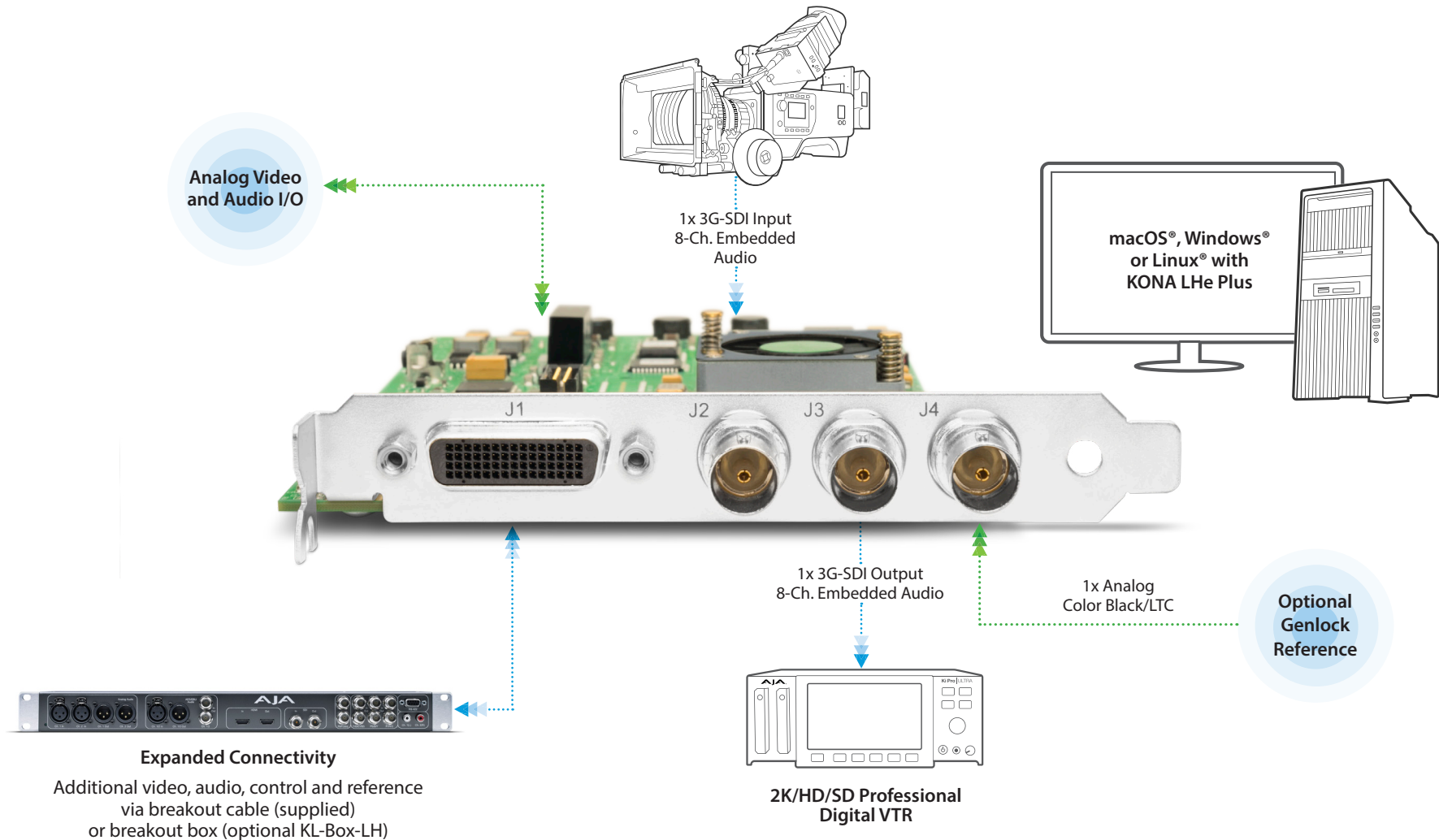

Connect your digital sources via HD/SD-SDI or HDMI to KONA for capture and editing via a wide variety of formats. Master to any digital or analog device through high quality professional SDI, HDMI or component outputs.



KONA® LHe Plus

Tech Specs

Video Formats

- (HD) 1080i 50, 59.94, 60
- (HD) 1080p 23.98, 24, 25, 29.97, 30
- (HD) 1080PsF 23.98, 24, 25, 29.97, 30
- (HD) 720p 50, 59.94, 60
- (SD) 625i 50
- (SD) 525i 59.94

Video Input Digital

- SD/HD SDI, SMPTE-259/292/296, 8 or 10-bits
- Single Link 4:2:2 (1x BNC)

Video Input Analog

- Composite/S-Video (Y/C) (1x BNC/2x BNC+Adapter)
- NTSC, NTSCJ, PAL
- Component (3x BNC)
- HD: YPbPr, RGB
- SD: YPbPr, RGB (component mode)
- SMPTE/EBU N10, Betacam 525 line, Betacam 525J, RGB
- 12-bit A/D, 8x oversampling
- +/- .2 dB to 5.0 MHz Y Frequency Response
- +/- .2 dB to 1 MHz C Frequency Response
- .5% 2T pulse response
- <1% Diff Phase
- <1% Diff Gain
- <1 ns Y/C delay inequity

Video Output Digital

- HD SDI, SMPTE-292/296, 10-bit
- SD SDI, SMPTE-259M, 10-bit

Video Output Analog

- Composite/S-Video (Y/C) (1x BNC/2x BNC+Adapter)
- NTSC, NTSCJ, PAL
- Component (3x BNC)
- HD: YPbPr, RGB
- SD: YPbPr, RGB (component mode)
- SMPTE/EBU N10, Betacam 525 line, Betacam 525J, RGB
- 12-bit D/A, 8x oversampling
- +/- .2 dB to 5.0 MHz Y Frequency Response
- +/- .2 dB to 1 MHz C Frequency Response
- .5% 2T pulse response
- <1% Diff Phase
- <1% Diff Gain
- <1 ns Y/C delay inequity

Audio Input Digital

- 8-Channel, 16 and 24-bit SMPTE-259 SDI embedded audio, 48 kHz sample rate, synchronous
- 2-Channel, 16 and 24-bit AES/EBU audio, 48 kHz or 96 kHz sample rate, synchronous or nonsynchronous, internal sample rate conversion (via 1x XLR on breakout cable or optional KL-Box)

Audio Input Analog

- 2-Channel, 16 and 24-bit A/D analog audio, 48 kHz sample rate, balanced (via 2x XLR on breakout cable or optional KL-Box)
- +24 dBu Full Scale Digital
- +/- 0.2 dB 20 Hz to 20 kHz frequency response

Audio Output Digital

- 8-Channel, 16 and 24-bit SMPTE-259 SDI embedded audio, 48 kHz sample rate, synchronous
- 2-Channel, 16 and 24-bit AES/EBU audio, 48 kHz or 96 kHz sample rate, synchronous or nonsynchronous, internal sample rate conversion (via 1x XLR on breakout cable or optional KL-Box)

Audio Output Analog

- 2-Channel, 16 and 24-bit D/A analog audio, 48 kHz sample rate, balanced (via 2x XLR on breakout cable or optional KL-Box)
- +24 dBu Full Scale Digital (0 dBFS)
- +/- 0.2 dB 20 Hz to 20 kHz frequency response
- 2-Channel unbalanced output (via 2x RCA jacks on optional KL-Box)

Down-conversion

- Hardware 10-bit
- Anamorphic: fullscreen
- Letterbox: image is reduced with black top and bottom added to image area with the aspect ratio preserved
- Crop: image is cropped to fit new screen size

Reference Input

- Analog Color Black (1V) or Composite Sync (2 or 4V)
- Looping
- 75 ohms on optional KL-Box, terminated on supplied breakout cable

Electrical Interface

- 4-lane PCIe 1.0

Machine Control

- RS-422, Sony 9-pin protocol (via breakout cable or optional KL-BOX)
- 9-pin D-connector pinout is as follows:

1	GND	7	RX+
2	RX-	8	TX-
3	TX+	9	GND
4	GND	Shell	GND
5	No Connection		
6	GND		

Size (w x d x h)

- 0.75" x 8.25" x 5.0" (19.05 x 209.55 x 127.00 mm)

Weight

- 0.7 lb (0.4 kg)

Power

- 13W typical, 15W maximum

Environment

- Safe Operating Temperature: 0 to 40 C (32 to 104 F)
- Safe Storage Temperature (Power OFF): -40 to 60 C (-40 to 140 F)
- Operating Relative Humidity: 10-90% noncondensing
- Operating Altitude: <3,000 meters (<10,000 feet)

[Click here](#)

For full product specifications visit www.aja.com/en/products/kona-lhe-plus/#techspecs



Three Year Warranty

AJA Video warrants that KONA® products will be free from defects in materials and workmanship for a period of three years from the date of purchase.

About AJA Video Systems, Inc.

Since 1993, AJA Video has been a leading manufacturer of video interface and conversion solutions, bringing high quality, cost effective digital video products to the professional, broadcast and postproduction markets.

AJA products are designed and manufactured at our facilities in Grass Valley, California, and sold through an extensive sales channel of resellers and systems integrators around the world. For further information, please see our website at www.aja.com