

**Kramer Electronics, Ltd.**

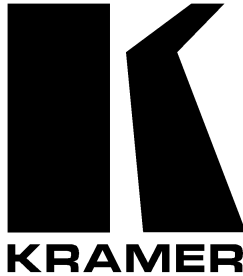

# **USER MANUAL**

## **Wall Plate Series:**

**WAV-5, WAV-5C, WAV-5YC,**

**WAV-3, WA-1P, WA-1H, WAV-1R, WAV-1RP**

## Contents

<b>1</b>	<b>Introduction</b>	<b>1</b>
<b>2</b>	<b>Getting Started</b>	<b>1</b>
<b>3</b>	<b>Overview</b>	<b>1</b>
<b>4</b>	<b>WAV-5, WAV-5C, and WAV-5YC Wall Plate Inserts</b>	<b>2</b>
4.1	WAV-5	2
4.2	WAV-5C	2
4.3	WAV-5YC	2
<b>5</b>	<b>WAV-3, WA-1P, WA-1H, WAV-1R, WAV-1RP Wall Plate Inserts</b>	<b>6</b>
5.1	WAV-3	6
5.2	WA-1P	6
5.3	WA-1H	7
5.4	WAV-1R	7
5.5	WAV-1RP	8

## Figures

Figure 1: WAV-5	3
Figure 2: WAV-5C	4
Figure 3: WAV-5YC	5
Figure 4: WAV-3	6
Figure 5: WA-1P	6
Figure 6: WA-1H (Front)	7
Figure 7: WA-1H (Rear)	7
Figure 8: WAV-1R (Front)	7
Figure 9: WAV-1R (Rear)	7
Figure 10: WAV-1RP	8

## 1 Introduction

Welcome to Kramer Electronics (since 1981): a world of unique, creative and affordable solutions to the infinite range of problems that confront the video, audio and presentation professional on a daily basis. In recent years, we have redesigned and upgraded most of our line, making the best even better! Our 500-plus different models now appear in 8 Groups<sup>1</sup>, which are clearly defined by function.

Congratulations on purchasing your Kramer Wall Plate<sup>2</sup> / Wall Plate Insert<sup>2</sup>, which is ideal for these applications: board, conference and training rooms, presentation systems, and long distance signal distribution and home theater.

## 2 Getting Started

We recommend that you:

- Unpack the equipment carefully and save the original box and packaging materials for possible future shipment
- Review the contents of this user manual
- Use Kramer high performance high resolution cables<sup>3</sup>

## 3 Overview

This user manual describes the following wall plate inserts:

- **WAV-5, WAV-5C and WAV-5YC** (see section 4)
- **WAV-3, WA-1P, WA-1H, WAV-1R, and WAV-1RP** (see section 5)

To achieve the best performance you should:

- Connect only good quality connection cables, thus avoiding interference, deterioration in signal quality, and elevated noise levels (often associated with low quality cables)
- Position your Kramer wall plate insert securely, and in a location that is free from moisture and away from excessive sunlight and dust

---

1 GROUP 1: Distribution Amplifiers; GROUP 2: Video and Audio Switchers, Matrix Switchers and Controllers; GROUP 3: Video, Audio, VGA/XGA Processors; GROUP 4: Interfaces and Sync Processors; GROUP 5: Twisted Pair Interfaces; GROUP 6: Accessories and Rack Adapters; GROUP 7: Scan Converters and Scalers; and GROUP 8: Cables and Connectors

2 Each is supplied with the required screws

3 The complete list of Kramer cables is on our Web site at <http://www.kramerelectronics.com>

## 4 WAV-5, WAV-5C, and WAV-5YC Wall Plate Inserts

This section describes the following Wall Plate Inserts<sup>1</sup>:

- **WAV-5** (see section 4.1)
- **WAV-5C** (see section 4.2)
- **WAV-5YC** (see section 4.3)

### 4.1 WAV-5

The **WAV-5** is a one-gang wall plate insert (see Figure 1) with pass through connectors for:

- Computer graphics video on an HD15 connector and unbalanced stereo audio on a 3.5mm mini plug connector
- Video (composite or SDI) on a yellow RCA connector and unbalanced stereo audio on RCA connectors (white for L and red for R), and

### 4.2 WAV-5C

The **WAV-5C** is a one-gang wall plate insert (see Figure 2) with pass through connectors **and 5 cables with BNC connectors on the rear included<sup>2</sup>** for:

- Computer graphics video on an HD15 connector and unbalanced stereo audio on a 3.5mm mini plug connector
- Video (composite or SDI) on a yellow RCA connector and unbalanced stereo audio on RCA connectors (white for L and red for R)

### 4.3 WAV-5YC

The **WAV-5YC** is a one-gang wall plate insert (see Figure 3) with pass through connectors for:

- Computer graphics video on an HD15 connector and unbalanced stereo audio on a 3.5mm mini plug connector
- s-Video on a 4p connector and unbalanced stereo audio on RCA connectors (white for L and red for R)

---

<sup>1</sup> Available in three versions: one for Belgium and Germany, one for England and Europe (except Belgium and Germany), and one for the United States

<sup>2</sup> Colored red (R), green (G), blue (B), black (Vertical sync) and yellow (Horizontal sync)



Destination: Belgium and Germany

Destination: England and Europe

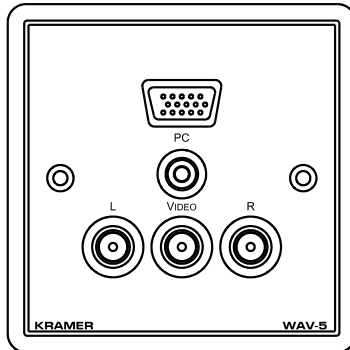
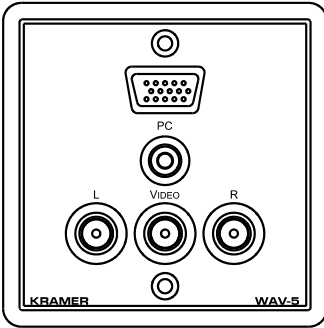

Destination: United States

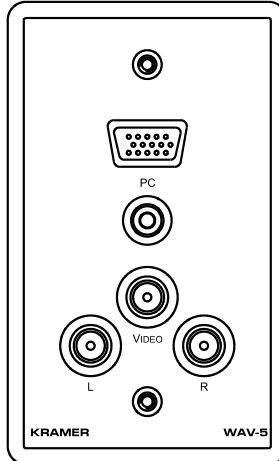
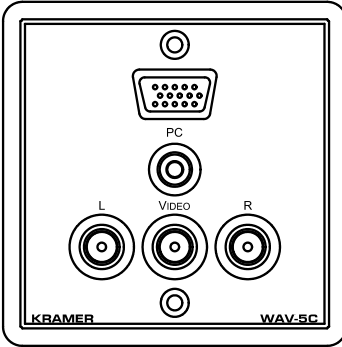

Figure 1: WAV-5



**Destination: Belgium and Germany**



**Destination: England and Europe**

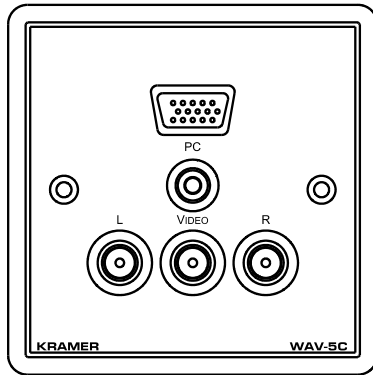

**Destination: United States**

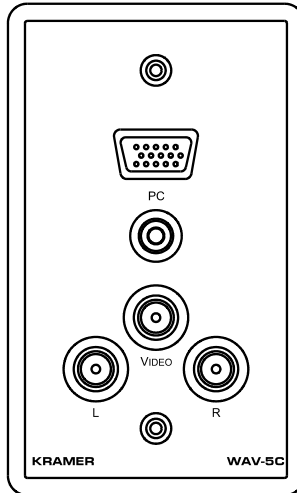
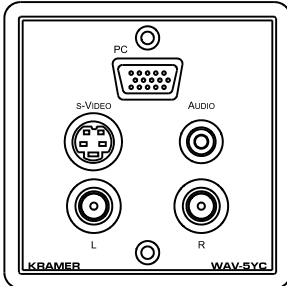

Figure 2: WAV-5C



Destination: Belgium and Germany



Destination: England and Europe

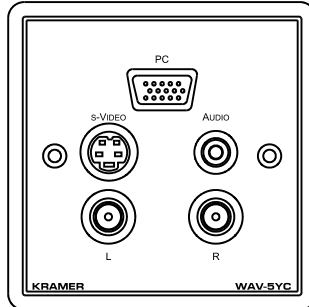

Destination: United States

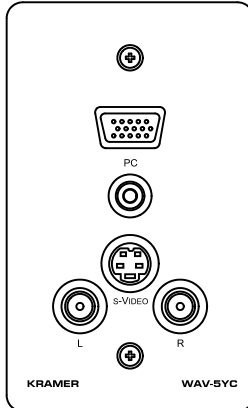

Figure 3: WAV-5YC

## 5 WAV-3, WA-1P, WA-1H, WAV-1R, WAV-1RP Wall Plate Inserts

This section describes the following wall plate inserts:

- **WAV-3** (see section 5.1)
- **WA-1P** (see section 5.2)
- **WA-1H** (see section 5.3)
- **WAV-1R** (see section 5.4)
- **WAV-1RP** (see section 5.5)

### 5.1 WAV-3

The **WAV-3** is a dual-insert wall plate insert (see Figure 4) with pass through connectors for video (composite or SDI) on a yellow RCA connector and unbalanced stereo audio on RCA connectors (white for L and red for R):

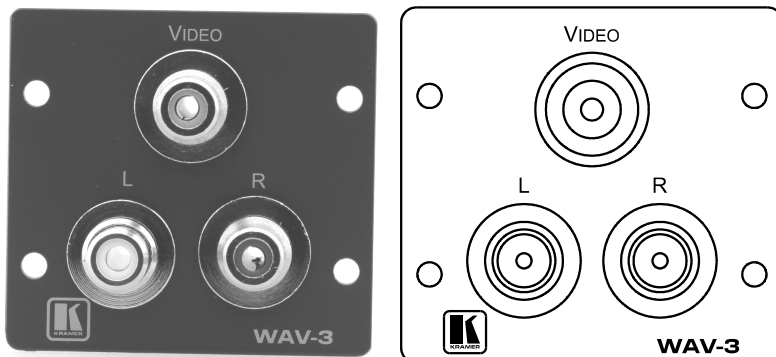

Figure 4: WAV-3

### 5.2 WA-1P

The **WA-1P** is a single-insert wall plate insert with a pass through connector for unbalanced stereo audio on a 3.5mm mini plug connector.



Figure 5: WA-1P



### 5.3 WA-1H

The **WA-1H** is a single-insert wall plate insert (see Figure 6) for unbalanced stereo audio on a 3.5mm mini plug connector with a terminal block connector on the rear (see Figure 7)

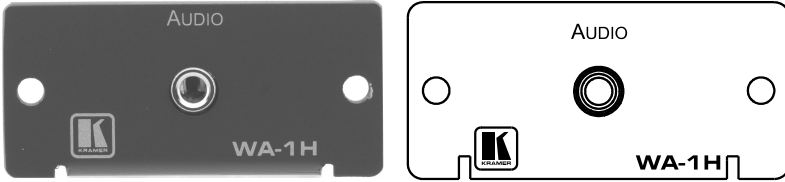

Figure 6: WA-1H (Front)

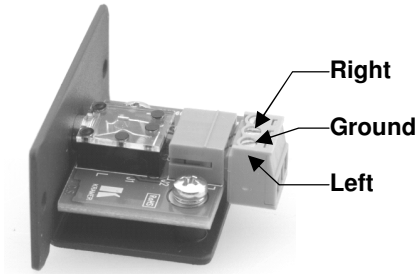

Figure 7: WA-1H (Rear)

### 5.4 WAV-1R

The **WAV-1R** is a single insert wall plate insert (see Figure 8) for video (composite or SDI) on a yellow RCA connector and unbalanced stereo audio on a 3.5mm mini plug connector, with a terminal block connector on the rear (see Figure 9):

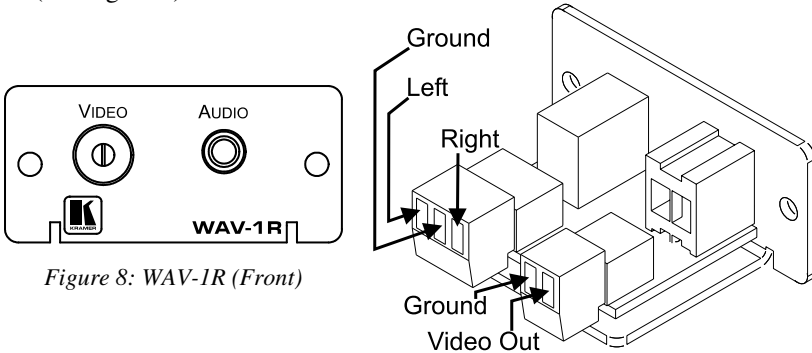

Figure 8: WAV-1R (Front)

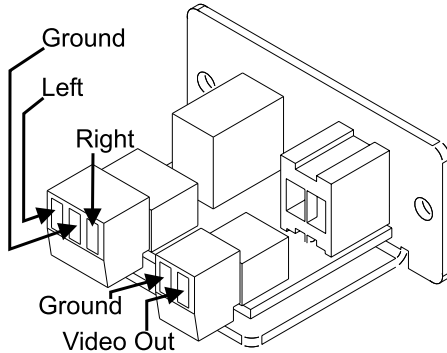
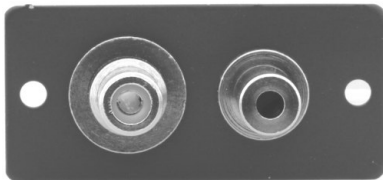

Figure 9: WAV-1R (Rear)

## 5.5 WAV-1RP

The **WAV-1RP** is a wall plate insert with pass through connectors for video (composite or SDI) on a yellow RCA connector and unbalanced stereo audio on a 3.5mm mini plug connector (see Figure 10).



*Figure 10: WAV-1RP*

---

## LIMITED WARRANTY

Kramer Electronics (hereafter *Kramer*) warrants this product free from defects in material and workmanship under the following terms.

### HOW LONG IS THE WARRANTY

Labor and parts are warranted for seven years from the date of the first customer purchase.

### WHO IS PROTECTED?

Only the first purchase customer may enforce this warranty.

### WHAT IS COVERED AND WHAT IS NOT COVERED

Except as below, this warranty covers all defects in material or workmanship in this product. The following are not covered by the warranty:

1. Any product which is not distributed by Kramer, or which is not purchased from an authorized Kramer dealer. If you are uncertain as to whether a dealer is authorized, please contact Kramer at one of the agents listed in the Web site [www.kramerelectronics.com](http://www.kramerelectronics.com).
2. Any product, on which the serial number has been defaced, modified or removed.
3. Damage, deterioration or malfunction resulting from:
  - i) Accident, misuse, abuse, neglect, fire, water, lightning or other acts of nature
  - ii) Product modification, or failure to follow instructions supplied with the product
  - iii) Repair or attempted repair by anyone not authorized by Kramer
  - iv) Any shipment of the product (claims must be presented to the carrier)
  - v) Removal or installation of the product
  - vi) Any other cause, which does not relate to a product defect
  - vii) Cartons, equipment enclosures, cables or accessories used in conjunction with the product

### WHAT WE WILL PAY FOR AND WHAT WE WILL NOT PAY FOR

We will pay labor and material expenses for covered items. We will not pay for the following:

1. Removal or installations charges.
2. Costs of initial technical adjustments (set-up), including adjustment of user controls or programming. These costs are the responsibility of the Kramer dealer from whom the product was purchased.
3. Shipping charges.

### HOW YOU CAN GET WARRANTY SERVICE

1. To obtain service on you product, you must take or ship it prepaid to any authorized Kramer service center.
2. Whenever warranty service is required, the original dated invoice (or a copy) must be presented as proof of warranty coverage, and should be included in any shipment of the product. Please also include in any mailing a contact name, company, address, and a description of the problem(s).
3. For the name of the nearest Kramer authorized service center, consult your authorized dealer.

### LIMITATION OF IMPLIED WARRANTIES

All implied warranties, including warranties of merchantability and fitness for a particular purpose, are limited in duration to the length of this warranty.

### EXCLUSION OF DAMAGES

The liability of Kramer for any effective products is limited to the repair or replacement of the product at our option. Kramer shall not be liable for:

1. Damage to other property caused by defects in this product, damages based upon inconvenience, loss of use of the product, loss of time, commercial loss; or:
2. Any other damages, whether incidental, consequential or otherwise. Some countries may not allow limitations on how long an implied warranty lasts and/or do not allow the exclusion or limitation of incidental or consequential damages, so the above limitations and exclusions may not apply to you.

This warranty gives you specific legal rights, and you may also have other rights, which vary from place to place.

**NOTE:** All products returned to Kramer for service must have prior approval. This may be obtained from your dealer.

This equipment has been tested to determine compliance with the requirements of:

- EN-50081: "Electromagnetic compatibility (EMC);  
generic emission standard.  
Part 1: Residential, commercial and light industry"
- EN-50082: "Electromagnetic compatibility (EMC) generic immunity standard.  
Part 1: Residential, commercial and light industry environment".
- CFR-47: FCC Rules and Regulations:  
Part 15: "Radio frequency devices  
Subpart B Unintentional radiators"

### CAUTION!

- Servicing the machines can only be done by an authorized Kramer technician. Any user who makes changes or modifications to the unit without the expressed approval of the manufacturer will void user authority to operate the equipment.
- Use the supplied DC power supply to feed power to the machine.
- Please use recommended interconnection cables to connect the machine to other components.





**For the latest information on our products and a list of Kramer distributors, visit our Web site: [www.kramerelectronics.com](http://www.kramerelectronics.com), where updates to this user manual may be found. We welcome your questions, comments and feedback.**



---

**Kramer Electronics, Ltd.**

Web site: [www.kramerelectronics.com](http://www.kramerelectronics.com)

E-mail: [info@kramerel.com](mailto:info@kramerel.com)

P/N: 2900-000276 REV 1