

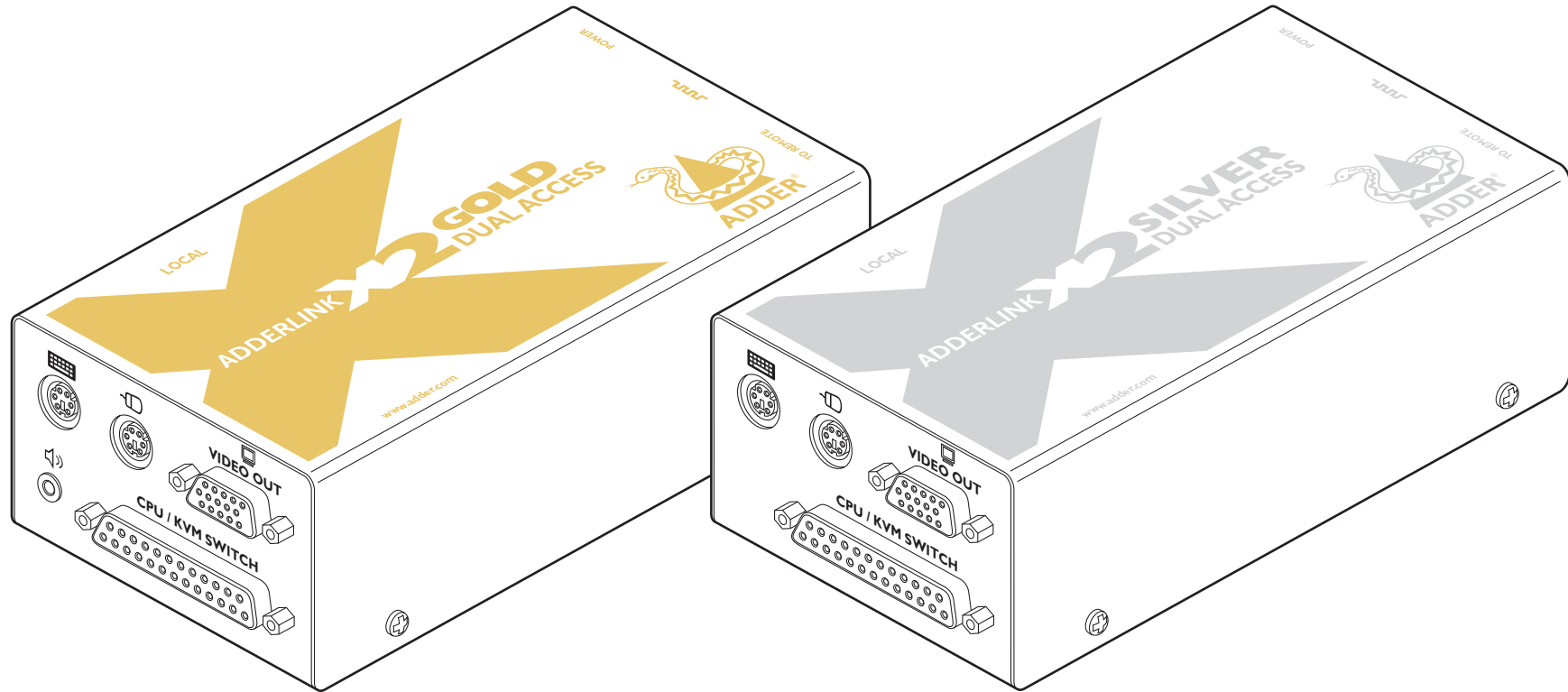

AdderLink X2 Dual Access

Remote Extenders



[CONTENTS](#)

Contents



Welcome

Introduction	2
Supplied items - X2 Dual Access Silver	3
Supplied items - X2 Dual Access Gold	4
Optional items	5

Installation and operation

Installation	6
Stage A - Configuration switch settings	6
LOCAL module switches	6
REMOTE module switches	7
Stage B - Mounting a module – desk or rack	8
Installation Advice	8
Stage C - Connections	9
Connections at the LOCAL module	9
Connections at the REMOTE module	11
Operation	13
Power and activity indicators	13
General use	13
User arbitration and keyboard indicators	13
Visible image shadows	13
Locking and unlocking the system	14

Special configuration

Configuration	15
What are hotkeys?	15
Entering, using and exiting configuration mode	15
Password setting	16
Password override	16
Hot plugging and mouse restoration	17
Which restore setting do I use?	17
Microsoft and Logitech -specific mouse settings	17
Image controls - sharpness and brightness	18
Skew adjustment	19
Miscellaneous settings	21

Further information

Troubleshooting	22
Getting assistance	22
Emissions and Immunity	24

Welcome



Introduction

Thank you for choosing the AdderLink X2 Dual Access extenders. Comprising two compact modules, the X2 Dual Access extenders allow you to place a duplicate keyboard, video monitor, mouse and a serial device up to 300 metres from a computer system. Two users can simultaneously view the output of the host system and either can take control, providing it is not being used by the other user. A user relinquishes control two seconds after their last key press or mouse movement.

Silver and Gold variants of the X2 Dual Access extender set are available, with the latter providing the capability to also duplicate the audio accessories away

from the host system computer. For both variants, a local module attaches to the computer system and provides connections for the local peripherals while the remote module is placed up to 300m away (200m maximum for Gold variant) and handles the remote peripherals. The long distance link between the two modules is made via Category 5, or higher, twisted pair cabling.

Special circuitry within the remote module allows you to make adjustments to the sharpness and brightness settings to suit your own preferences. Additionally, a Skew adjustment is also provided to counteract the effects of uneven lengths of twisted pair cables that are used to carry the video signals.

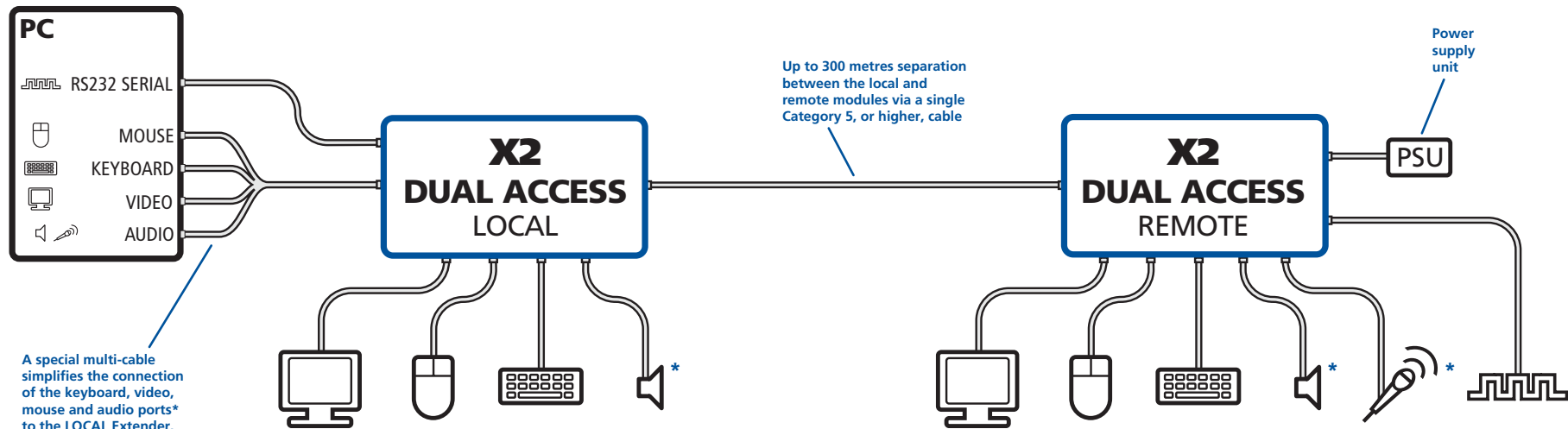

A special multi-cable simplifies the connection of the keyboard, video, mouse and audio ports* to the LOCAL Extender.

The video monitor, mouse, keyboard and audio* peripherals adjacent to the host computer connect to the LOCAL module. Note that the serial device and microphone* connections are not available at the LOCAL module.

The duplicate video monitor, mouse, keyboard, serial device and audio* peripherals connect to the REMOTE module.

* X2 Dual Access Gold variants only

CONTENTS

WELCOME

INSTALLATION & OPERATION

SPECIAL CONFIGURATION

FURTHER INFORMATION

Supplied items - X2 Dual Access Silver

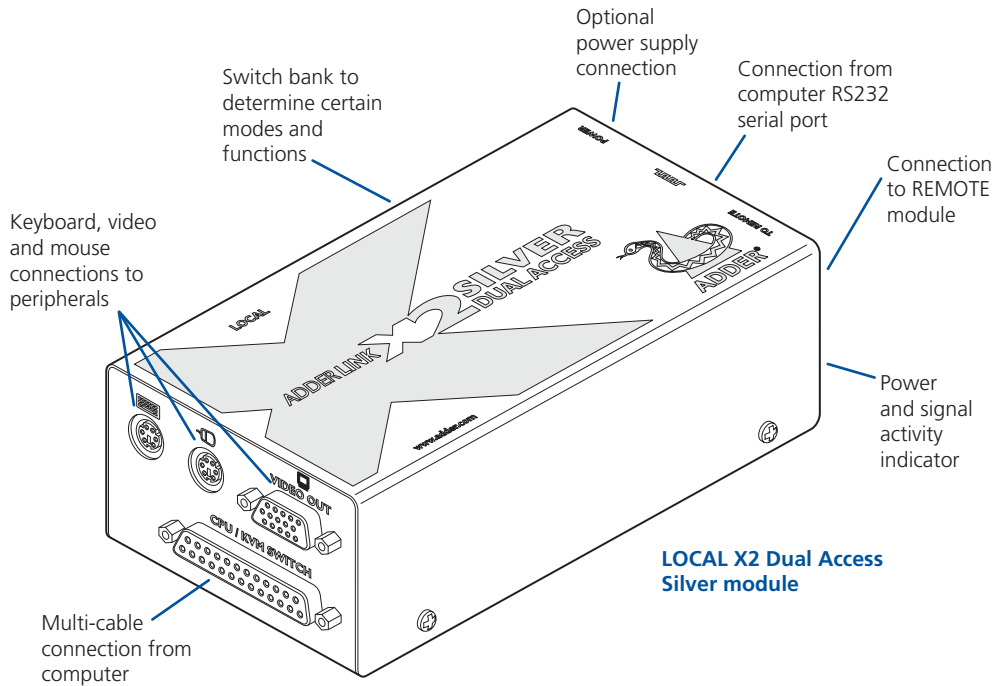

LOCAL X2 Dual Access Silver module

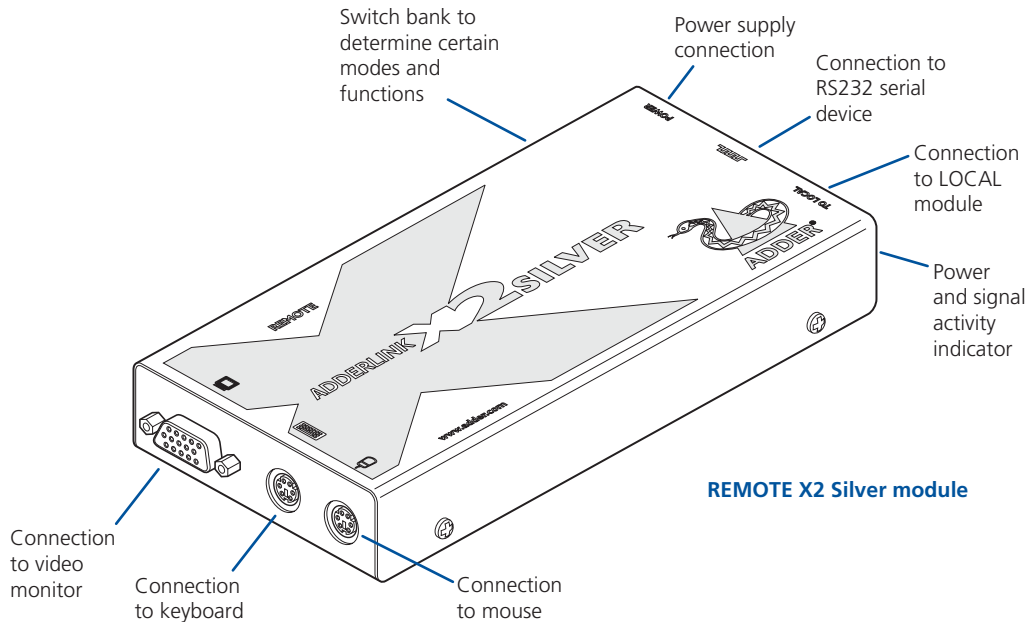
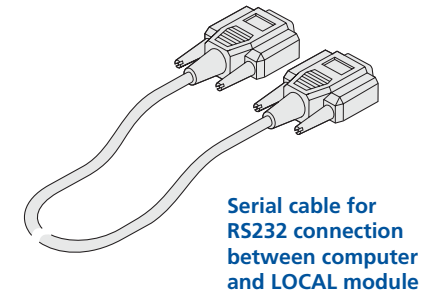
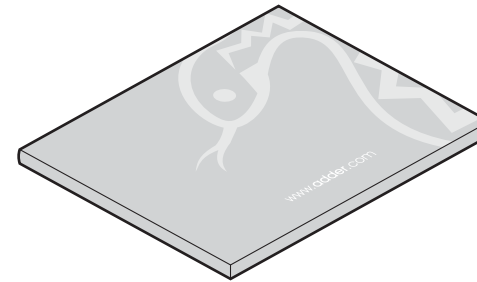
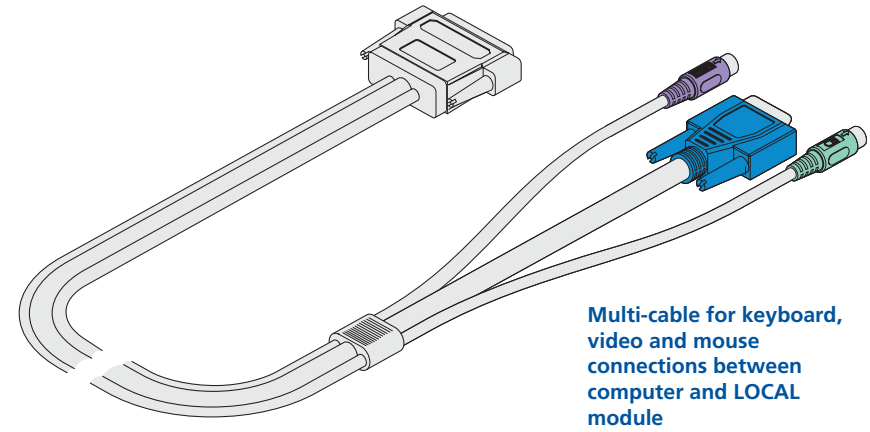

REMOTE X2 Silver module

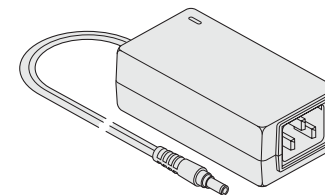

CONTENTS

WELCOME

INSTALLATION & OPERATION

SPECIAL CONFIGURATION

FURTHER INFORMATION

Supplied items - X2 Dual Access Gold

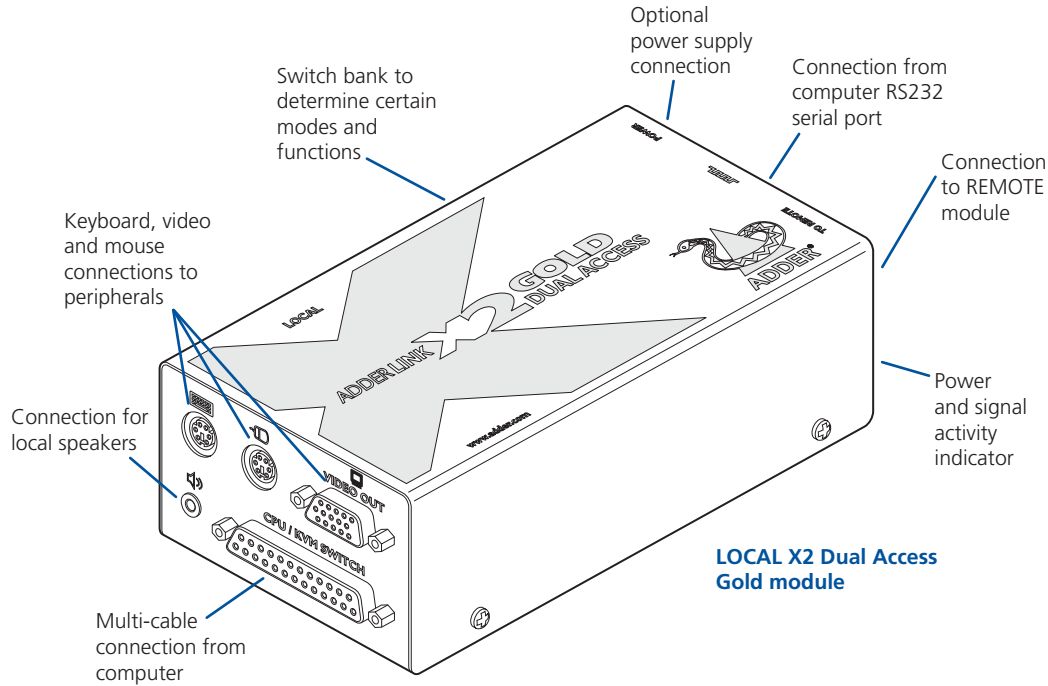

LOCAL X2 Dual Access Gold module

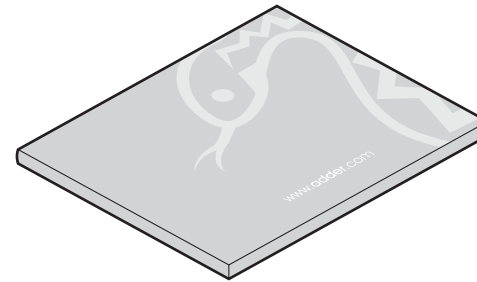
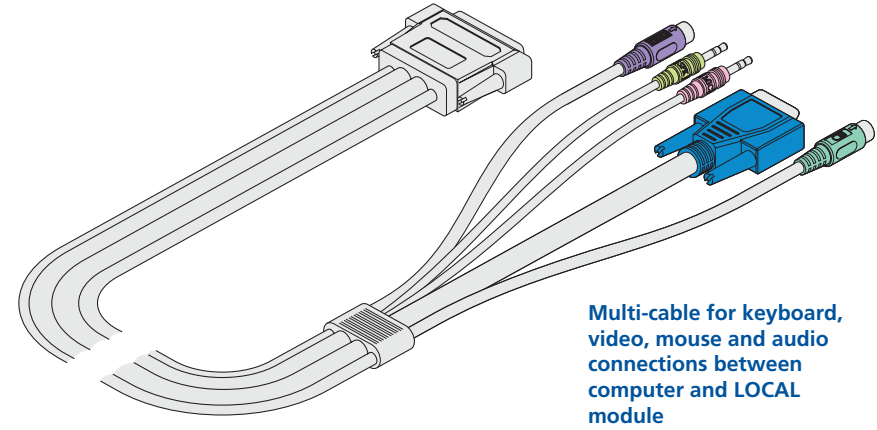

Information wallet containing:

Eight self-adhesive rubber feet
Safety document

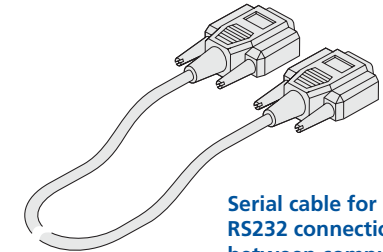

Serial cable for RS232 connection between computer and LOCAL module

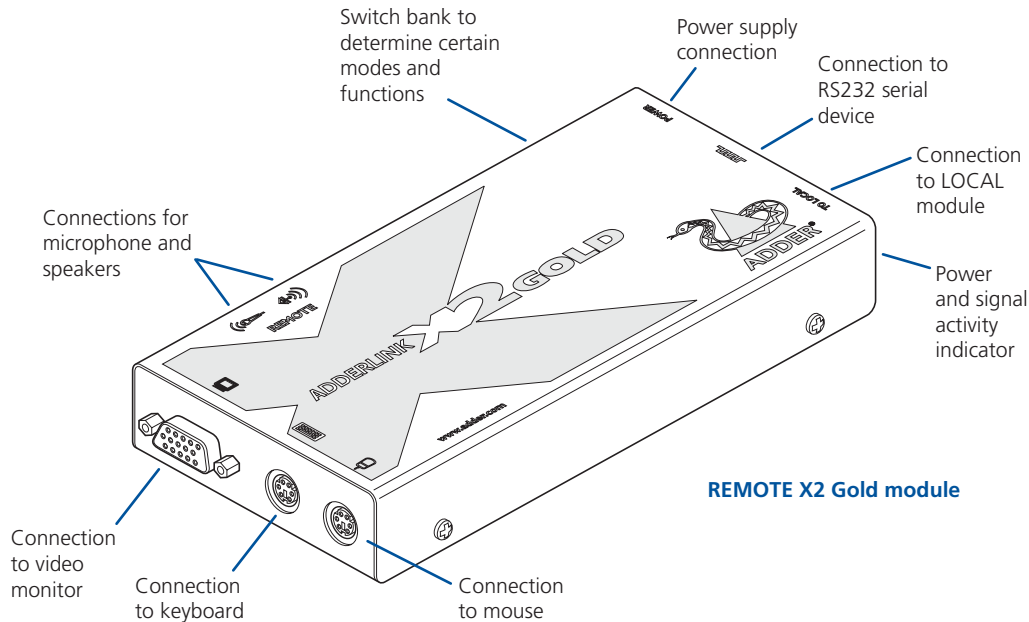

REMOTE X2 Gold module

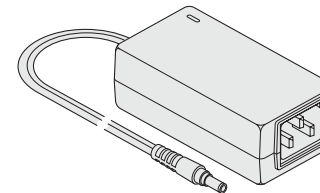

Power supply and country-specific mains cable

CONTENTS

WELCOME

INSTALLATION & OPERATION

SPECIAL CONFIGURATION

FURTHER INFORMATION

Optional items

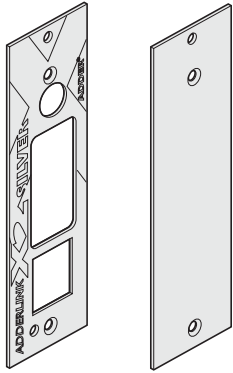

**Rack plate and blanking plate kit
for X2 Dual Access Silver**
Part number: X2-RMK-DA-SILVER

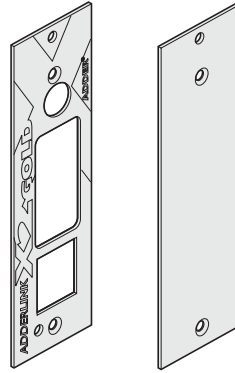

**Rack plate and blanking plate kit
for X2 Dual Access Gold**
Part number: X2-RMK-DA-GOLD

CONTENTS

WELCOME

INSTALLATION
& OPERATION

SPECIAL
CONFIGURATION

FURTHER
INFORMATION

Installation and operation

Installation

The installation of the X2 Dual Access extenders is straightforward and can best be achieved in most cases by following these stages for each module:

- **Stage A** Check or set the configuration switch settings
- **Stage B** Mount the module
- **Stage C** Connect the cables

Stage A - Configuration switch settings

The basic operation of the LOCAL and REMOTE modules are controlled by the banks of four switches located on the side of each module. The switches are monitored at all times and may be changed when power is on or off (the only exception to this rule is switch 1 of the LOCAL module which initiates slightly different functions depending on the power state when it is switched).

LOCAL module switches

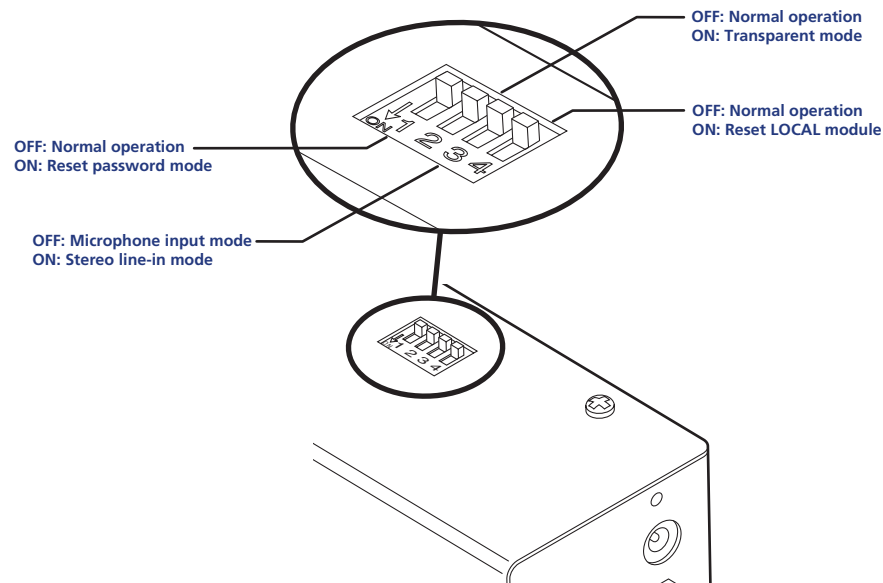

Note: When shipped, all switches are set in the OFF positions and this will produce normal operation with normal microphone input (at the REMOTE module).

LOCAL module switches (continued)

LOCAL Switch 1

OFF: Normal operation.

ON: (Whilst power is applied) Places the REMOTE module into password override mode. This allows any pre-configured passwords to be altered - particularly useful when they have been lost or forgotten. Please see the 'Password override' section in the 'Special configuration' chapter.

LOCAL Switch 2

OFF: Normal operation.

ON: Set transparent mode. Use this setting if the X2 Dual Access modules are to be used with KVM switches that are not manufactured by Adder Technology. Cascaded KVM switches often use special signals to set or identify conditions. In transparent mode, the X2 Dual Access modules will pass the signals without attempting to interpret them.

LOCAL Switch 3

OFF: Microphone input on REMOTE module. Use this setting if a standard mono-channel microphone is connected to the MIC input on the REMOTE unit.

ON: Stereo line-in input on REMOTE module. Use this setting if a stereo input is applied to the MIC input on the REMOTE unit.

LOCAL Switch 4

OFF: Normal operation.

ON: Suspend operation and reset the LOCAL module. Use this setting momentarily to produce the same effect as removing and restoring power if incorrect operation has occurred. Return the switch to the OFF position to allow normal operation to continue.

REMOTE module switches

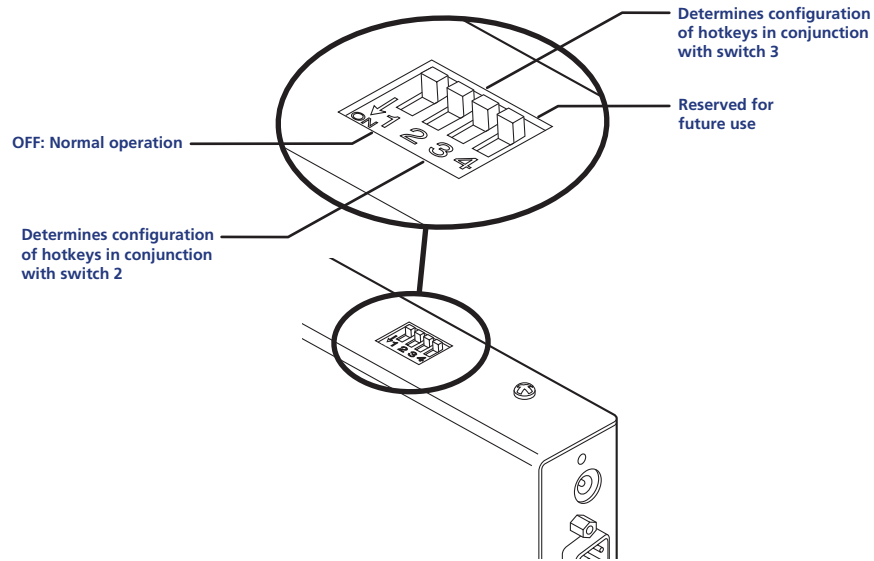

Note: When shipped, all switches are set in the OFF positions and this will produce normal operation.

REMOTE module switches (continued)

REMOTE Switch 1

OFF: Normal operation.

REMOTE Switches 2 and 3

Switches 2 and 3 determine which two keyboard keys (when pressed in unison) are to be designated as 'hotkeys'. Hotkeys signal to the REMOTE module that the next key to be pressed is a special configuration command for the module and is not to be passed to the computer system.

2 OFF

3 OFF Hotkeys = CTRL and SHIFT

2 ON

3 ON Hotkeys = ALT and SHIFT

2 ON

3 OFF Hotkeys = CTRL and ALT

2 ON

3 ON Hotkeys disabled

REMOTE Switch 4

This switch is reserved for future use.



CONTENTS

WELCOME

INSTALLATION
& OPERATION

SPECIAL
CONFIGURATION

FURTHER
INFORMATION

Stage B - Mounting a module – desk or rack

The X2 Dual Access extender modules can be situated on a desk (or floor) or alternatively, for larger installations, mounted within optional rack mount chassis units.

Desk mount

Apply the supplied self-adhesive rubber feet to the underside of the module(s).

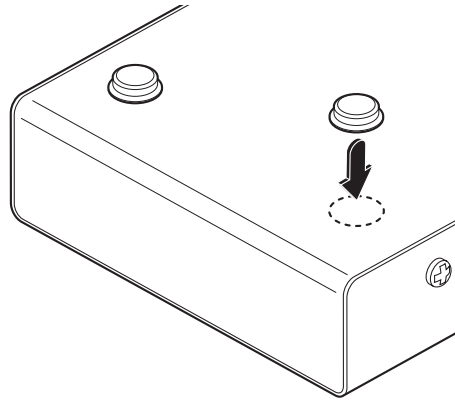

Installation Advice

- For correct operation, the local and remote units must have ground connections. At the computer end, ensure that the computer or KVM switch that the LOCAL module is connected to has a ground connection. At the keyboard/monitor/mouse end, ensure that the REMOTE module's power supply is connected to a grounded power outlet. Alternatively, a ground connection will be made via the monitor, if the monitor is itself grounded.
- Try to avoid laying the interconnect cable alongside power cables where possible.



CONTENTS

WELCOME

INSTALLATION
& OPERATION

SPECIAL
CONFIGURATION

FURTHER
INFORMATION

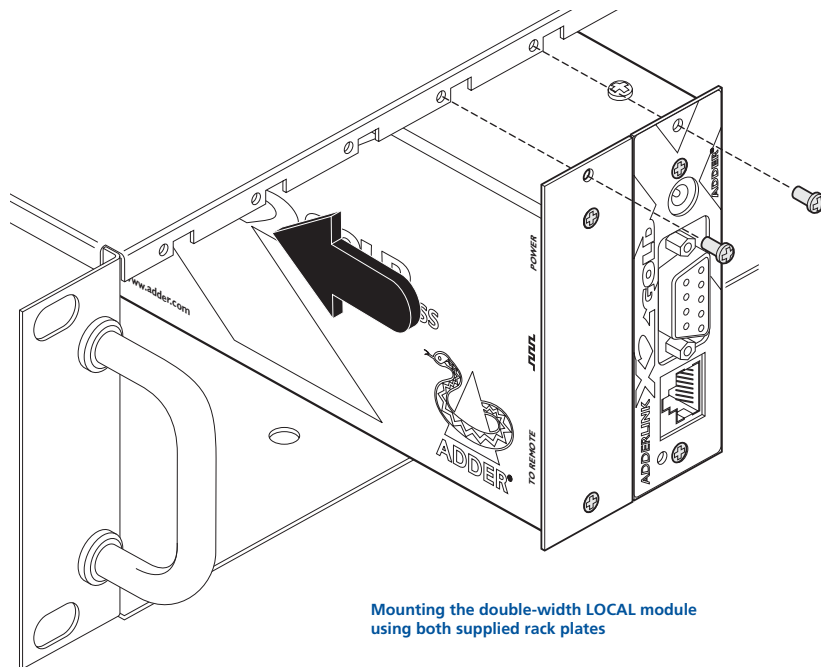

Mounting the double-width LOCAL module using both supplied rack plates

Rack mount

Note: The module switches are not accessible once it is inserted into the rack, therefore, check all settings before insertion.

- 1 Place the supplied rack plate(s) onto the front of the module and secure it with the countersunk screws.
- 2 Orient the module on its side so that its labelled face is the correct way up and the securing plate(s) is/are facing away from the rack.
- 3 Slide the module into the required rack position. The rectangular cut-out in the front upper lip of the rack allows the two screws on the module's upper edge to slide through.
- 4 The rack mount chassis has a series of holes in its floor that are spaced to accommodate the two screws on the module's lower edge. Ensure that the screws correctly locate into the two holes of the chosen slot. The rack securing plate(s) on the module should now be flush with the front of the rack mount chassis.
- 5 Use the supplied (pan-head) screw(s), in the top hole of the rack securing plate(s) to fasten the module to the rack.

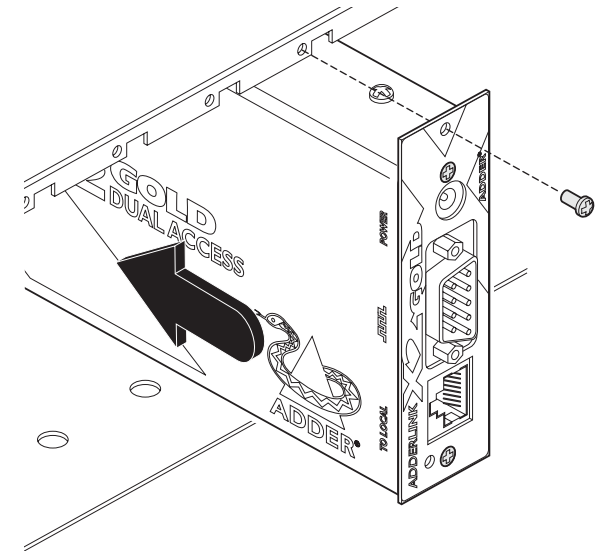

Mounting the REMOTE module using the single cut-out rack plates

Stage C - Connections

The naming of the LOCAL and REMOTE modules relate to their proximity to the computer system. Hence, the LOCAL module connects directly to the system (and the local peripherals), while the REMOTE is at the other end of the twisted pair cable and attaches to the duplicate keyboard, mouse, etc.





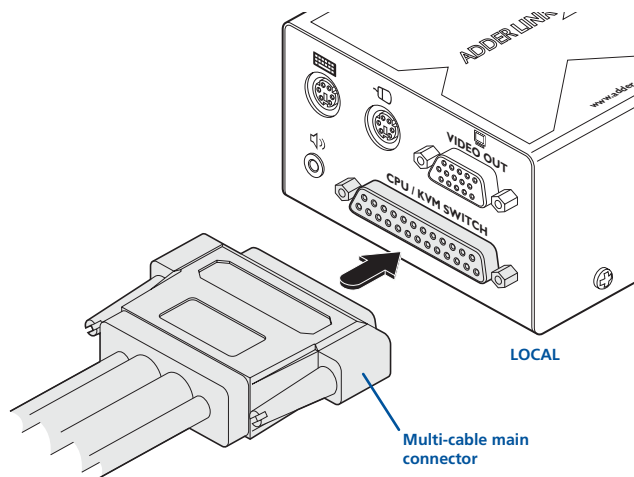

Connections at the LOCAL module

Multi-cable connection

Most of the connections between the computer system and the LOCAL module are made via the supplied multi-cable. This has a single connection to the module, is two metres in length and splits out to the keyboard, video, mouse and (for the Gold variant) microphone and speaker ports of the system.

- 1 Attach the supplied multi-cable to the 25-way socket at the end of the LOCAL module.
- 2 At the other end of the multi-cable, attach the keyboard, mouse and video, (plus optionally on Gold variant, the microphone and speaker) connectors to the appropriate sockets at the rear of the computer system. On most systems the appropriate ports should be labelled and colour coded in a similar way to the cable connectors:



Monitor (video)			Blue
Keyboard			Purple
Mouse		or	 Mid green
Speaker		or	SPK Light green
Microphone		or	MIC Pink (or maroon)

Serial cable connection

The X2 Dual Access extender modules offer the option to attach an RS232 serial device (such as a touch screen input) via the remote link. The link supports software or hardware handshaking up to a maximum baud rate of 56Kb/s. To make the serial connection between the LOCAL module and your computer system, use the supplied serial link cable.

Note: It is not possible to attach a duplicate serial device at the LOCAL module.

- 1 Attach male connector of the serial link cable to the 9 pin port on the LOCAL module, labelled **LOCAL**.
- 2 Connect the other end of the serial link cable to the appropriate serial port of the computer system.

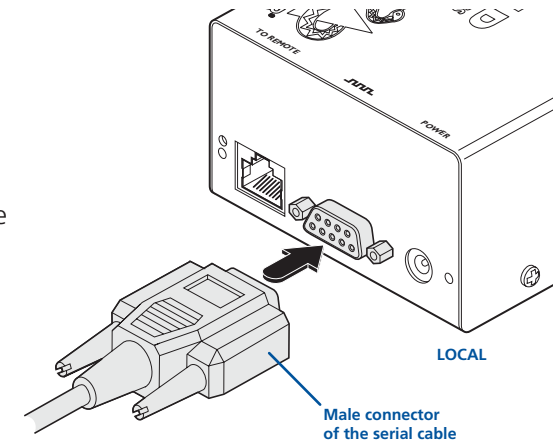

Twisted pair connection

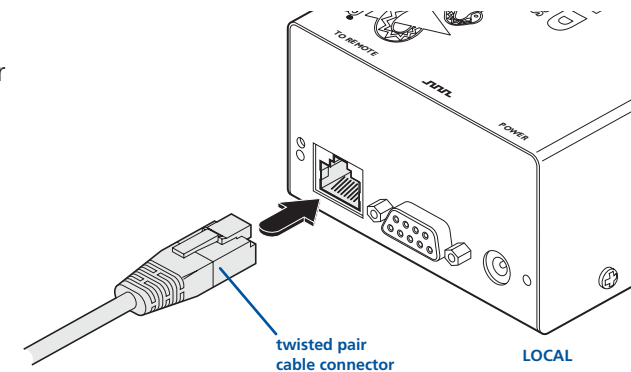

The link between the LOCAL and REMOTE modules is made via twisted pair cable, specified to Category 5 or higher. Ensure that the total twisted pair cable length (including patch boxes) does not exceed 300 metres for the Silver variant and 200 metres for the Gold variant.

- 1 Insert the connector from the twisted pair cable link into the socket marked 'TO REMOTE'.



Local keyboard, video and mouse connections

The LOCAL module provides extra ports to accommodate a keyboard, video monitor and mouse in the vicinity of the host system.

- 1 Attach the lead from the monitor to the blue D-type socket labelled **VIDEO OUT** on the LOCAL module.
- 2 Connect the keyboard lead to the purple mini-DIN socket labelled  on the LOCAL module.
- 3 Insert the keyboard lead into the green mini-DIN socket labelled  on the LOCAL module.

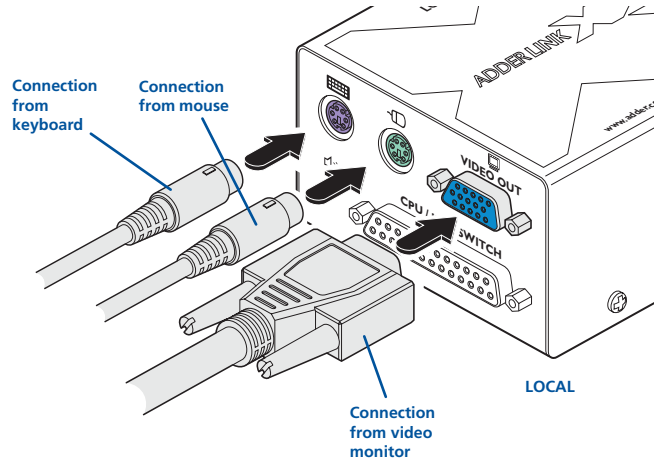

Local speaker connection

The Gold variant of the LOCAL module allows a pair of speakers to be connected and used in the vicinity of the host system.

Note: A microphone port is provided only at the REMOTE module. The speaker and microphone ports are absent from the Silver variant of the X2 Dual Access product.

- 1 Connect the speaker plug to the socket labelled .

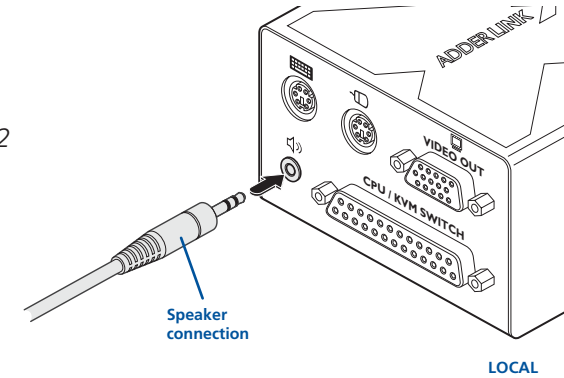

Optional power connection

The LOCAL module has a power socket, however, as power is derived from the host system keyboard connection, it is generally not necessary to use a power supply unit.

In situations where a keyboard connection to the host system is not used, the LOCAL module will require a separate power supply unit of the same type as supplied for use with the REMOTE module. Separate power supply units are available from Adder Technology Limited direct (www.shop.adder.com) or from your local supplier - part number: PSU-IEC-5VDC.

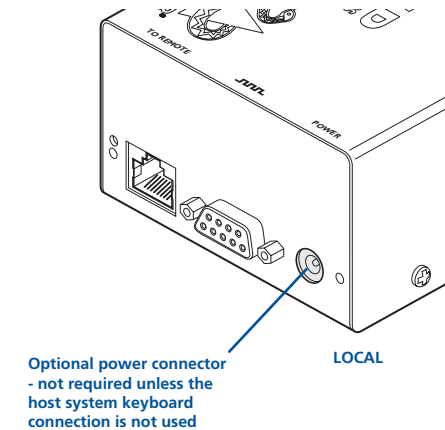

CONTENTS

WELCOME

INSTALLATION
& OPERATION



SPECIAL
CONFIGURATION

FURTHER
INFORMATION

Connections at the REMOTE module

Keyboard, video and mouse connections

The connections to the keyboard, video monitor and mouse are all made to the sockets at one end of the REMOTE module.

- 1 Attach the lead from the monitor to the blue D-type socket labelled  on the REMOTE module.
- 2 Connect the keyboard lead to the purple mini-DIN socket labelled  on the REMOTE module.
- 3 Insert the keyboard lead into the green mini-DIN socket labelled  on the REMOTE module.

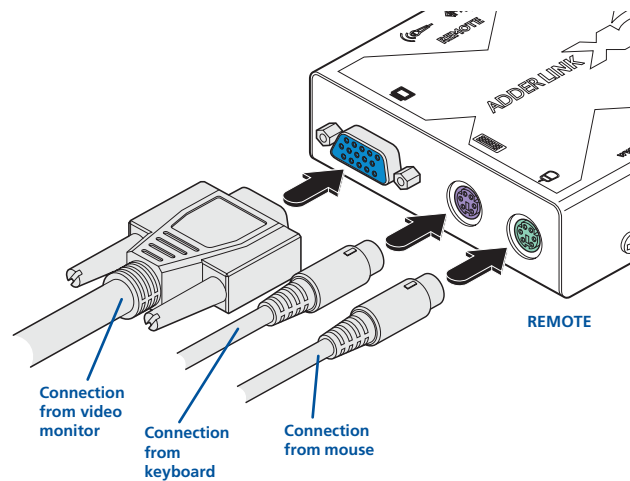

Twisted pair, power and serial connections

- 1 Insert the connector from the twisted pair cable link into the socket marked 'TO LOCAL'.
- 2 Attach the output connector of the power supply to the socket at the front edge of the REMOTE module labelled POWER.
- 3 If a serial connection is to be used, attach the lead from your serial device to the 9 way male connector on the REMOTE module labelled .

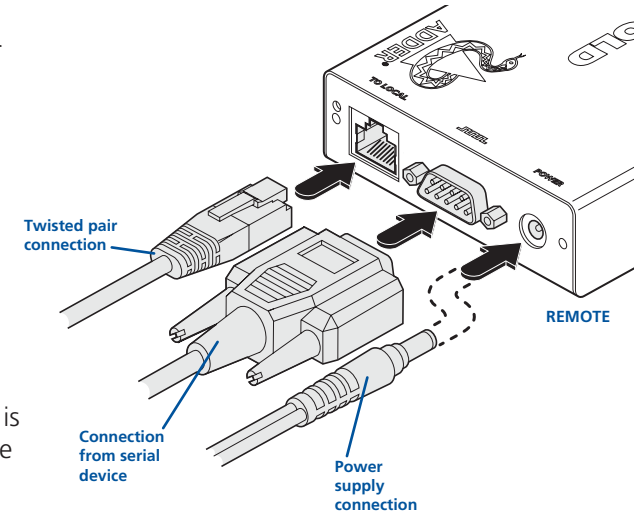

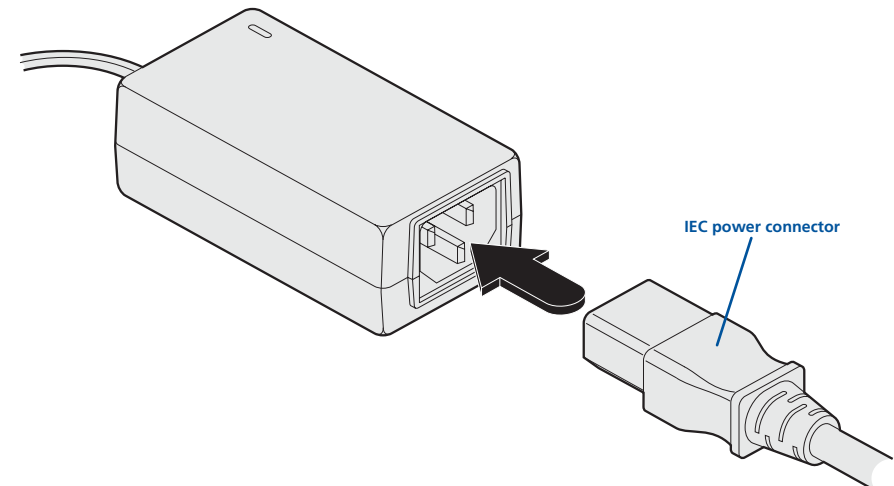

Power supply connection

- 1 Insert the IEC connector of the supplied power lead into the corresponding socket of the power supply. Connect the other end of the power lead to a nearby mains socket.



Audio connections (Gold only)

On the X2 Gold REMOTE module, audio connections are available at the two 3.5" jack sockets mounted on the side (same side as the switch bank). Note: The microphone input (labelled ) has a dual function whereby it can either support a mono-channel microphone or alternatively receive stereo line input. Switch 3 on the LOCAL module controls the setting of this port: LOCAL switch 3 OFF - microphone, LOCAL switch 3 ON - stereo line in.

- 1 Connect the microphone (or stereo line input) plug to the REMOTE module socket labelled .

Note: Ensure that the setting of switch 3 on the LOCAL module matches the input to this socket:
OFF-microphone;
ON-stereo line input).

- 2 Connect the speaker plug to the socket labelled .

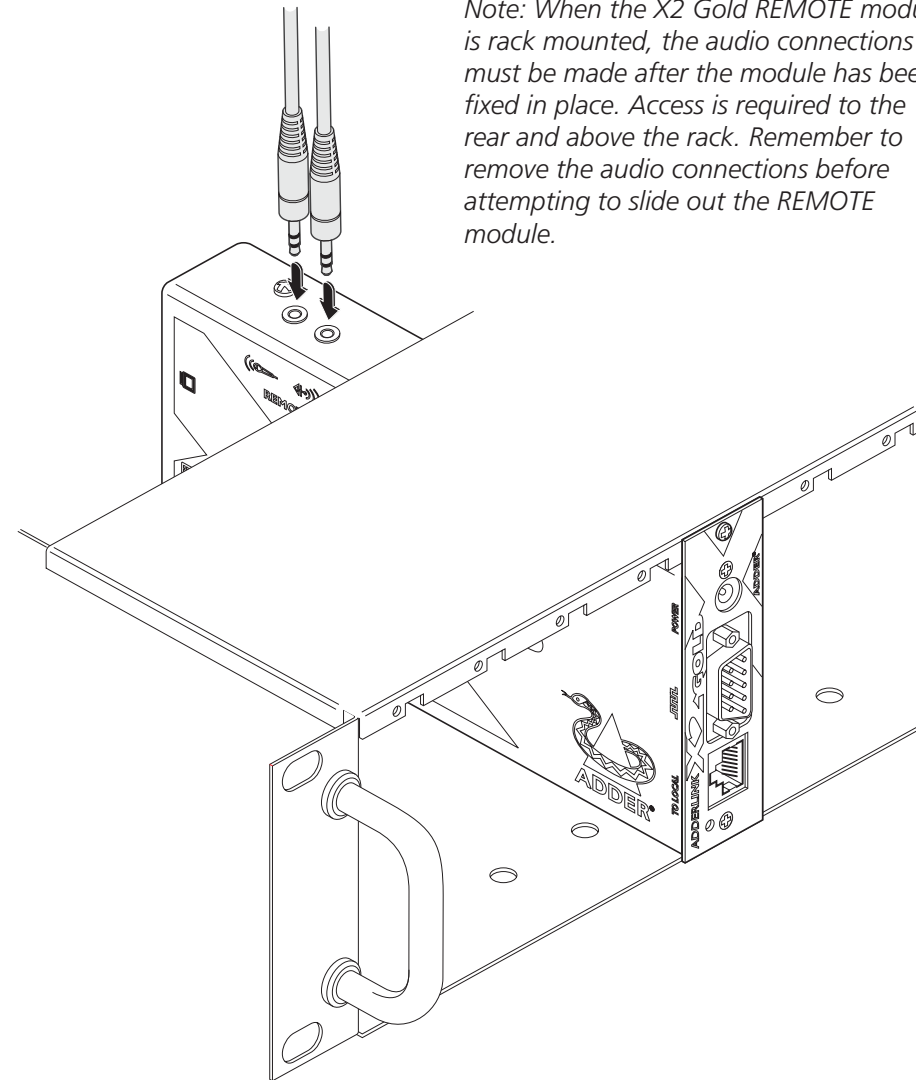
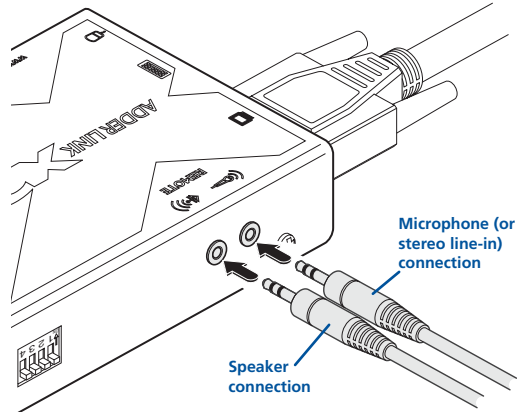

Note: When the X2 Gold REMOTE module is rack mounted, the audio connections must be made after the module has been fixed in place. Access is required to the rear and above the rack. Remember to remove the audio connections before attempting to slide out the REMOTE module.

Operation

Power and activity indicators

On the front panel of both modules are small recessed indicators which provide confirmation of power and activity, as follows:

- Constant red - *power applied, no communication activity.*
- Flickering red - *power applied, mouse or keyboard activity occurring.*
- Slow flashing red - *module is in flash upgrade mode.*

Note: Both modules contain internal automatic cut-out fuses to protect against power surges. To reset, remove power (or, for the LOCAL module, the multi-cable connection) from the module for one second and then reconnect.

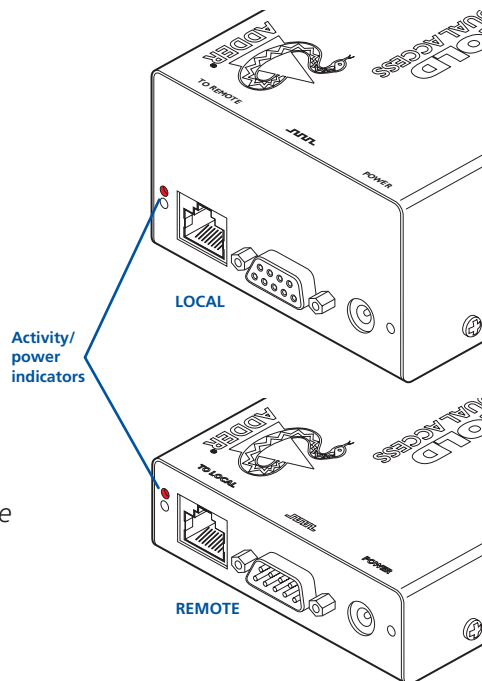

General use

In use, the X2 Dual Access modules should be almost transparent - the system and its peripherals should operate almost exactly as normal, the only difference being that they are duplicated (see 'User arbitration' below) and one set is now up to 300 metres away.

User arbitration and keyboard indicators

During operation, both of the connected video monitors continuously receive the output from the host system. Control of the host system is arbitrated by the X2 Dual Access modules on a first come, first served basis. In the idle state, control is available to both users and their keyboard indicators both show the current Num Lock, etc. conditions of the host system.

At the moment that a key is pressed or a mouse is moved, the keyboard and mouse of the other user are temporarily locked-out (the video images remain). The keyboard indicators of the locked-out user then begin to flash to confirm their status ⇒

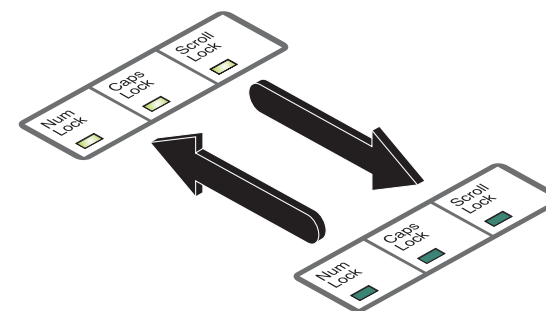

After two seconds of inactivity from the user currently in control, the modules return to their idle condition and re-instate the keyboard indicators of the locked-out user.

Visible image shadows

In some installations, you may see some 'shadows' to the right of high contrast screen characters. This can be caused by an incorrectly selected sharpness setting and it may be necessary to make adjustments to correct this. Please see 'Image controls - sharpness and brightness' in the 'Special configuration' section.

Locking and unlocking the system

In situations where the computer system (and the LOCAL module) can be locked away, the X2 Dual Access modules offer a viable security system to deter unauthorised use. Once a password has been set, a simple key sequence allows the system to be quickly and securely detached from its peripherals. Only the correct password will reconnect the remote and local modules.

To lock the system

- 1 First set a password. For further details, please refer to the 'Password setting' section in the 'Special configuration' chapter.
- 2 Simultaneously press the currently configured hotkeys (by default, **Ctrl** and **Shift**) along with **L**.

The screen will go blank and the three keyboard indicators will begin alternately flashing between the 'Num Lock' and 'Scroll Lock', and 'Caps Lock'. This sequence indicates that a password is required.

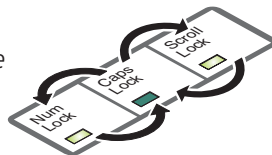

To unlock the system

- 1 Enter the correct password and press **Enter**.

Note: Passwords are NOT case sensitive.

*Note: If an invalid password has been entered and the keyboard indicators are not flashing as described above, press **Enter** to clear the incorrect attempt.*

- 2 If the correct password is entered, the screen will be restored and normal operation can continue.

To enable the video

Simultaneously press the currently configured hotkeys (by default, **Ctrl** and **Shift**) long with **F1**. This command will be required to restore the video if **Ctrl** and **Shift** along with **L** is used when no password has been set.

To disable the video

Simultaneously, press the currently configured hotkeys (by default, **Ctrl** and **Shift**) along with **F0**.

Special configuration

Configuration

You can alter the way that the X2 Dual Access modules operate to suit your requirements. This is done using the Configuration mode and you can affect the following settings:

- *Password setting* – allows you to lock the remote module to prevent unauthorised system access.
- *Mouse restoration and settings* – allows you to restore mouse operation and also to change the mouse type.
- *Image controls - sharpness & brightness* – allows you to manually adjust the video image to ensure that it is crisp and bright.
- *Skew adjustment* – allows you to manually compensate for possible video errors introduced by long, uneven cable connections.
- *Miscellaneous functions* – report firmware version and restore settings.

What are hotkeys?

Hotkeys are two normal keyboard keys that, when pressed simultaneously with a third key, signal to the X2 Dual Access modules that you are sending a message specifically to them and not to the computer. The hotkeys are ordinarily **Ctrl** and **Shift**, while a third keypress determines what you want the modules to do.

If the standard **Ctrl** and **Shift** hotkeys are also needed for computer tasks, you can change them for another combination using switches 2 and 3 on the REMOTE module:

- 2 OFF
- 3 OFF Hotkeys = **Ctrl** and **Shift** (default setting)
- 2 OFF
- 3 ON Hotkeys = **Alt** and **Shift**
- 2 ON
- 3 OFF Hotkeys = **Ctrl** and **Alt**
- 2 ON
- 3 ON Hotkeys disabled

Entering, using and exiting configuration mode

To enter and use configuration mode:

- 1 Simultaneously press the currently configured hotkeys (by default, **Ctrl** and **Shift**) along with **F1**.
The three keyboard indicators ('Num Lock', 'Caps Lock' and 'Scroll Lock') will now begin to flash in sequence to show that you are in configuration mode.
- 2 Press the first letter of the required configuration option, for instance **F**.
All three keyboard indicators will illuminate continuously.
- 3 Press the number of the required configuration option, for instance **8**.
The 'Scroll Lock' indicator will extinguish, leaving the 'Num Lock' and 'Caps Lock' indicators lit.
- 4 Press **F1** to confirm your option.
The three keyboard indicators ('Num Lock', 'Caps Lock' and 'Scroll Lock') will now begin to flash in sequence again.

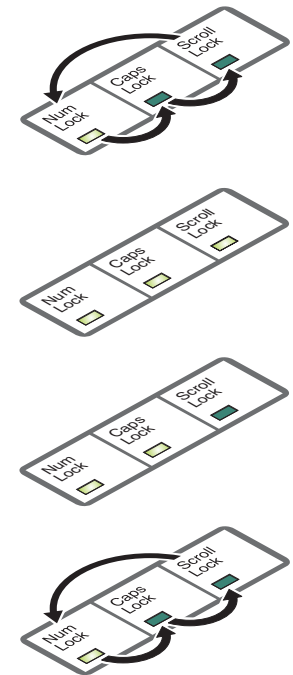

To exit from configuration mode:

- 1 Within configuration mode, the three keyboard indicators should be flashing in sequence to show that the module is ready to receive a new command.
- 2 Press **F1**.
The three indicators will return to their normal states.

Password setting

Password protection allows you restrict access to the system only to authorised personnel. A password first needs to be set and then, using the keyboard attached to the REMOTE module, a simple key sequence allows the system to be quickly and securely detached from its peripherals.

To set a password

- 1 Simultaneously, press the hotkeys (by default, **Ctrl** and **Shift**) along with **↵** to enter configuration mode.
- 2 Press **P** followed by **↵**.
- 3 Now enter your new password, within the following constraints:
 - Passwords are NOT case sensitive,
 - Passwords may be any length from one character to a maximum of forty characters,
 - The following keys may NOT be used: **Ctrl**, **Alt**, **Shift**, or **↵**
- 4 When you have entered the password, press **↵** to signal its completion.
- 5 Press **↵** once more to exit configuration mode.

For full details about how to lock and unlock the system using your password, please see the 'Locking and unlocking the system' section in the 'Installation and operation' chapter.

Password override

This mode allows you to override the password that has been set at the REMOTE module and place it into configuration mode so that a new one may be set. This feature is particularly useful when passwords have been lost or forgotten.

To override the REMOTE password

- 1 Remove power from the REMOTE module.
- 2 With power to the system and LOCAL module still applied, change LOCAL switch 1 to the ON position.
- 3 Re-apply power to the REMOTE module. The REMOTE module will go directly into configuration mode so that the old password can be cleared and a new one set.
 - **To clear a password:** (within configuration mode) Press **P** followed by **↵** and followed by **↵** again.
 - You can now enter a new password using the procedure outlined in steps 2 to 5 of the 'Password setting' section, or press **↵** to exit configuration mode.
- 4 Return LOCAL switch 1 to its OFF position.

Note: If switch 1 remains ON, then the REMOTE module will enter configuration mode whenever it is repowered and will not operate normally.



Hot plugging and mouse restoration

It is strongly recommended that you switch off the computer system before attempting to connect it via the X2 Dual Access modules. However, if this is not possible then you need to 'hot plug' the X2 Dual Access modules while power is still applied to the system. There is not normally a danger of damage to the system, however, when mouse communications are interrupted, often they fail to reinitialise when reconnected. X2 Dual Access modules provide a feature to reinstate mouse communications once the necessary connections have been made.

There are two main types of data formats used by current PC mice, these are the older 'PS/2' format and the more recent 'IntelliMouse®' format introduced by Microsoft. These use slightly different data arrangements and it is important to know which type was being used before you hot-plugged the X2 Dual Access modules. The previous setting depends both on the type of mouse and the type of driver as various combinations of PS/2 and Intellimouse are possible. Using the incorrect restore function may produce unpredictable results and require the system to be rebooted.

Which restore setting do I use?

The general rule is that unless both the mouse *and* the driver are *both* Intellimouse compatible then you need to restore the mouse as 'PS/2'.

Recognising an Intellimouse-style mouse

The Intellimouse format was introduced to support, among other features, the scroll wheel function. If your mouse has a scroll wheel, then it is likely to support the Intellimouse format. If you have a Microsoft mouse, then it will usually state that it is an Intellimouse on its underside label.

Recognising an Intellimouse driver

Before hot plugging your X2 Dual Access modules (or afterwards using only keyboard control), access the Windows Control Panel and select either the *Mouse* option (on Windows NT, 2000 and XP) or the *System* option (on Windows 95, 98, ME). Look for the name of the driver, which will usually include the words *PS/2* or *Intellimouse*.

To restore mouse operation when hot plugging:

- 1 Carefully connect the X2 Dual Access modules to the system and its keyboard, mouse, monitor, audio and serial device.
- 2 Simultaneously, press the hotkeys (by default, **Ctrl** and **Shift**) along with **F1** to enter configuration mode.
- 3 Enter the appropriate restore function code:
 - *PS/2* – press **M** **6** **F1**
 - *IntelliMouse* – press **M** **7** **F1**
- 4 To exit configuration mode, press **F1**.
- 5 Move the mouse a short distance and check for appropriate on-screen cursor movement. If the mouse cursor darts erratically around the screen, then cease moving the mouse. This is an indication that the chosen restore function is incorrect. Try again using the other restore function.
Note: The restore functions predict the likely mouse resolution settings but may not restore the exact speed or sensitivity settings that were originally set.

Microsoft and Logitech -specific mouse settings

In certain installations some Logitech mouse drivers may lose the action of the mouse buttons when used with the standard 'Microsoft compatible' signalling protocol used between the modules. To solve this problem, select the 'Logitech compatible' mouse signalling protocol.

To change mouse signalling protocols

- 1 Simultaneously, press the hotkeys (by default, **Ctrl** and **Shift**) along with **F1** to enter configuration mode.
- 2 Enter the appropriate protocol code:
 - *Microsoft compatible* – press **M** **3** **F1**
 - *Logitech compatible* – press **M** **4** **F1**
- 3 To exit configuration mode, press **F1**.



Image controls - sharpness and brightness

The X2 Dual Access modules incorporate special controls to compensate for losses incurred within long cable links. Using these controls you can adjust the picture sharpness and brightness to improve your remote picture quality.

The need for image control adjustment is best discovered when viewing high contrast images with vertical edges, such as black lines on a white background. When doing so, if you notice that the screen image is 'fuzzy' or 'dark' then the image controls may be able to solve this condition.

Note: If the high contrast images exhibit shadows with separate colours, then there may be a skew problem which requires a different image adjustment - see the 'Skew adjustment' section for details.

To display a suitable high contrast image

The best way to clearly view the effect of sharpness and brightness adjustments is to display a high contrast image, with vertical edges, on the screen.

- Open a word processor, type the capital letter 'H', or 'M' and increase the point size to 72 or higher. For best results, the background should be white and the character should be black.
- A BLACK shadow on the right of the character indicates UNDER compensation.
- A WHITE shadow on the right of the character indicates OVER compensation.

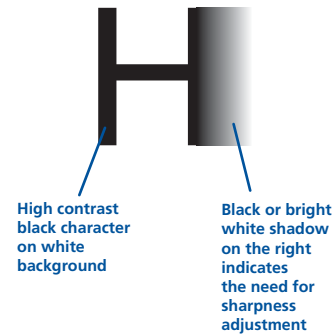

To use the image controls

- 1 Simultaneously, press the hotkeys (by default, **Ctrl** and **Shift**) along with **F2** to enter configuration mode.

The three keyboard indicators ('Num Lock', 'Caps Lock' and 'Scroll Lock') will now begin to flash in sequence. The speed of the sequence indicates the level of the sharpness adjustment currently applied: the slower the rate, the lower the level of sharpness being applied.

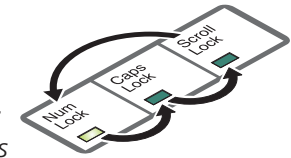

- 2 While viewing the displayed high contrast screen image, use the following keys to adjust the controls:

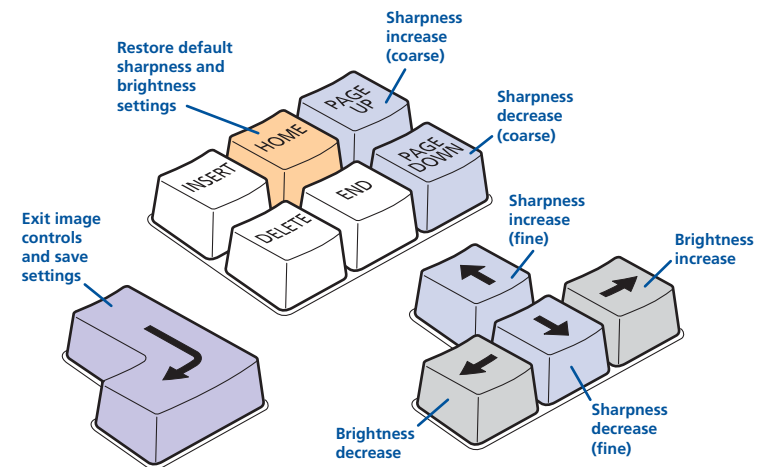

Sharpness: **↑** **↓** for fine adjustment, **Page Up** **Page Down** for coarse adjustment.

There are 255 sharpness levels (one coarse step jumps 10 levels).

To autoselect sharpness: Press **F2** **F2** **F2** to make the module calculate and apply an automatic compensation level - you can use this as a starting point for your fine tuning.

*Note: If the monitor goes blank and switches off (due to oversetting the sharpness adjustment) press the **Home** key to restore.*

Brightness: **←** **→** for adjustment. There are 255 brightness levels.

- 3 When no shadows are visible and the displayed images have crisp edges, press **F2** to exit configuration mode and permanently save all settings. The new compensation setting will be stored, even when power is removed or if a complete reset is initiated. The setting should not require further changes unless the cabling arrangement is altered.

If the image controls cannot provide a crisp image

If, after adjusting the image controls, the screen image remains fuzzy or has coloured shadows you may need to use the Skew adjustment feature. Please see the next section for details.

Skew adjustment

The twisted pair cabling supported by the X2 Dual Access modules (category 5, or higher) consists of four pairs of cables. Three of these pairs are used by the modules to convey red, green and blue video signals to the remote video monitor. Due to the slight difference in twist rate between these three pairs, the red, green and blue video signals may not arrive at precisely the same time. This is visible as separate colour shadows on high contrast screen images. This effect is particularly apparent when using higher screen resolutions and some types of category 5e cables.

In this situation, the X2 Dual Access modules provide internal skew adjustment that can help to rectify the situation. The skew adjustment works by delaying or advancing the timing of any of the red, green or blue colour signals so that they are all delivered to the monitor at precisely the same time. For best results a test pattern generator is available free of charge from the Adder website (see right) and this should be displayed when using skew adjustment.

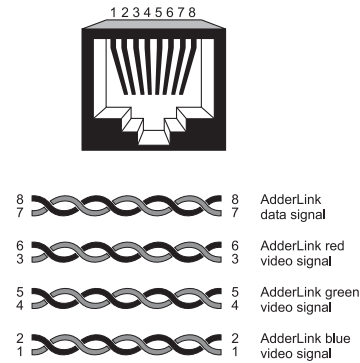

To obtain and run the free Adder test pattern generator

- 1 Visit www.adder.com.
- 2 Click the **PRODUCTS** heading and then choose **Management Software**.
- 3 From the list of software utilities, choose the **ADDER Test Pattern Generator** option.
- 4 Click the **Downloads** tab and choose the **ADDER Test Pattern Generator** option to download the utility.
- 5 Unzip the downloaded file and run the **TESTpatterns.exe** file.
- 6 Click the **SKEW** option.

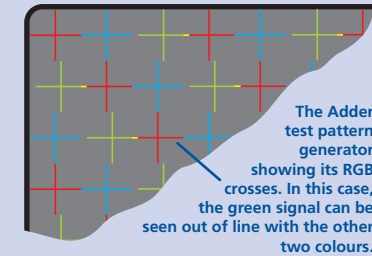

[See next page for skew adjustment details](#)

To use skew adjustment

- 1 Display the test pattern. See [To obtain and run the free Adder test pattern generator](#).

The screen will show a series of fine red, green and blue crosses which should all be in line, vertically and horizontally. Skew affects the horizontal placement of the colours and using this pattern it is much easier to discover which, if any, colours are being adversely affected by the twisted pair cable run.

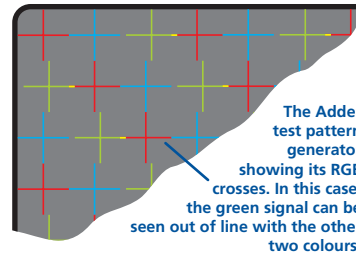

- 2 Simultaneously, press the hotkeys (by default, **Ctrl** and **Shift**) along with **F5** to enter configuration mode.

The three keyboard indicators ('Num Lock', 'Caps Lock' and 'Scroll Lock') will now begin to flash in sequence.

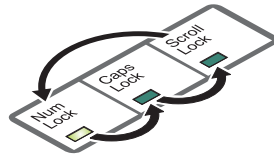

- 3 As appropriate, press either the R, G or B keyboard keys to select the appropriate colour channel. Corresponding keyboard indicators will flash rapidly to show which channel is currently selected for adjustment: Num Lock for Red, Caps Lock for Green and Scroll Lock for Blue.

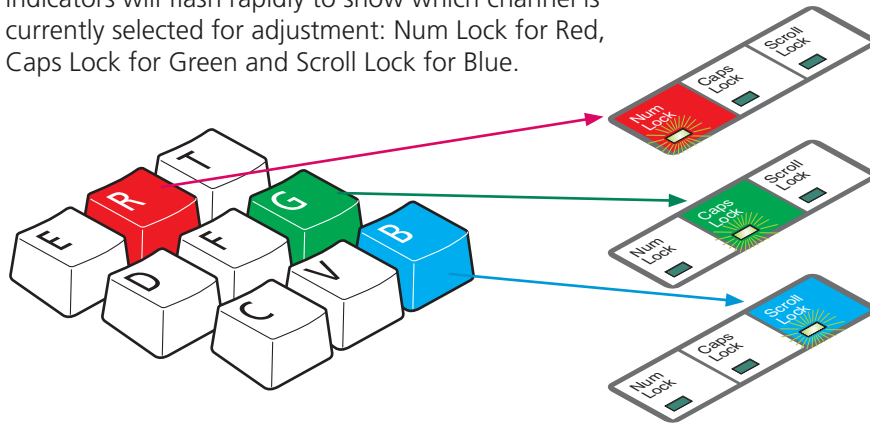

- 4 Press the **←** and **→** keys to retard or advance the timing of the selected colour channel respectively. On screen you will see a change in the position of the selected colour crosses in relation to the other two.

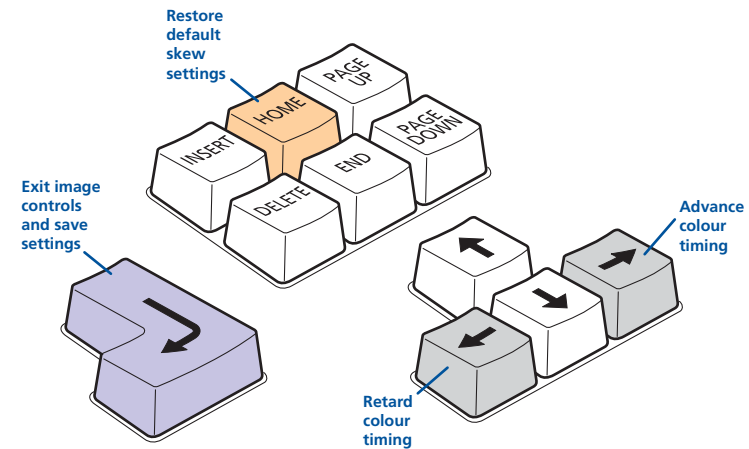

- 5 When the selected colour crosses are correctly positioned, press **F5** to exit that colour channel. The keyboard indicators will return to flashing in sequence.
- 6 If required, repeat steps 4 to 6 to select and adjust any colour channel until the vertical lines of the red, green and blue crosses are all aligned.
- 7 When all colours are correctly aligned, press **F5** to exit configuration mode and permanently save all settings.

Note: Once you have made a skew adjustment, it may be necessary to re-adjust the image controls to attain an optimum screen image.

Miscellaneous settings

The following are configuration settings within the modules that are not covered in other sections of this guide. These can be achieved once within configuration mode by pressing the indicated keys:

Report X2 Dual Access firmware version - **F1** ↵

Before initiating this command, ensure that the system is running an application that can display typed keys as screen characters - e.g. a word processor or Windows Notepad. The current firmware version will be written to the application in the form of the letter 'V' followed by three numbers - for example V201 means version 2.01.

Reset all configuration options to default states - **F8** ↵

Returns all user configurable options to the settings that are installed at manufacture. The password will be cleared, however, any current image control settings or skew adjustments will not be reset.

Further information



Troubleshooting

If you experience problems when installing or using the X2 Dual Access modules, please check through this section for a possible solution. If your problem is not listed here and you cannot resolve the issue, then please refer to the 'Getting assistance' section.

Video image at the REMOTE module is distorted or shadows appear to the right of displayed objects.

Adjustments are required to compensate for the length of the twisted pair cable being used. If video problems persist:

- Please refer to the 'Image controls - sharpness and brightness' section in the 'Special Configuration' chapter.
- If the overall video image is 'fuzzy' and/or has coloured shadows you may need to make skew adjustments. This procedure allows you to finely tune the red, green and blue video signal timings to overcome most colour separation problems. Please refer to the 'Skew adjustment' section in the 'Special Configuration' chapter.

No video image is received at the REMOTE module.

- Check that the power/activity indicators are lit on the LOCAL and REMOTE modules - if they are not, then there is a power problem. The LOCAL module gains its power either from the computer's keyboard socket or by using an optional power supply.

When keys are pressed or the mouse is moved, check that the indicators flicker – if they do not respond then there could be a twisted pair link problem or a problem with one of the modules.

- Check that the Category 5 (or higher) cable is wired correctly as per the diagram in the 'Skew adjustment' section in the 'Special Configuration' chapter.
- If possible, try using an alternative twisted pair connection between the modules.
- If the sharpness control is set too high, the monitor may not be able to display a picture. Try reinstating the factory default sharpness settings. Please refer to the 'Image controls - sharpness and brightness' section in the 'Special Configuration' chapter.
- Temporarily disconnect the video link to the LOCAL module, connect a monitor directly to the computer video port and check for a correct video image output.

The keyboard indicators are flashing between the Caps Lock and the Num Lock/Scroll Lock and the computer does not respond to any keyboard or mouse inputs.

- The modules are currently locked and require a valid password to be entered. Please refer to the section 'Locking and unlocking the system' for details.

Power is applied via the power supply but the REMOTE module operation has stopped.

- Each module has an internal automatic cut-out fuse to protect against power surges. To reset, remove power from the module for one second and then reconnect.

The on-screen mouse pointer does not respond to mouse movements

- The mouse connection may have been interrupted. Either, reboot the system and re-power the REMOTE module power supply, or try using the mouse restoration command. Please refer to the 'Hot plugging and mouse restoration' section in the 'Special Configuration' chapter.

Sound from the microphone cannot be heard or is very quiet

- Check the setting of LOCAL switch 3 - if a microphone is connected at the REMOTE module, the switch should be set OFF.

Sound input from the stereo line input is distorted ('tinny' sounding) and only one channel is working

- Check the setting of LOCAL switch 3 - if a stereo line input is connected at the REMOTE module, the switch should be set ON.

Getting assistance

If you are still experiencing problems after checking the information contained within this guide, then we provide a number of other solutions:

- **Online solutions and updates** – www.adder.com/support
Check the Support section of the adder.com website for the latest solutions and firmware updates.
- **Adder Forum** – forum.adder.com
Use our forum to access FAQs and discussions.
- **Technical support** – www.adder.com/contact-support-form
For technical support, use the contact form in the Support section of the adder.com website - your regional office will then get in contact with you.

CONTENTS

WELCOME

INSTALLATION
& OPERATION

SPECIAL
CONFIGURATION

FURTHER
INFORMATION

Products in the X2-Series range

The following related X2-Series items are also available:

- **X2-Gold Extender (part code: X2-Gold)**
This pair of modules allow you to extend not only keyboard, video and mouse signals up to 300 metres, but also similarly support microphone, stereo speaker and an RS232 serial channel.
- **X2-Silver Extender (part code: X2-Silver)**
As per the X2-Gold with the exception of the audio extension facility.
- **X2 Extender (part code: X2)**
As per the X2-Silver with the exception of the skew adjustment feature.
- **Dual Video Transmitter (part code: XDVT)**
Allows one system to be controlled from two locations or permits a second video channel to be sent to a remote location. Used in conjunction with two X2-Silver or X2 Remote modules.
- **Rack mount chassis (part code: RMK-CHASSIS)**
This 19" chassis allows multiple X2-Series modules to be neatly arranged within a standard cabinet. Securing plates and screws are supplied separately for each X2-Series module for use with the rack mount chassis.
- **Power distribution module (part code: X-PDM4)**
Provides power for up to four X2-Series modules to reduce mains power socket requirements.
- **Rack mount securing plates**
 - for X2-Gold modules (part code: X-RMK-GOLD)
 - for X2-Silver modules (part code: X-RMK-SILVER)
 - for X2 modules (part code: X-RMK)
 - single slot blanking plate (part code: X-RMK-BLANK)
 - quad slot blanking plate (part code: X-RMK-BLANK4)

Safety information

- For use in dry, oil free indoor environments only.
- Do not use to link between buildings.
- Ensure that the twisted pair interconnect cable is installed in compliance with all applicable wiring regulations.
- Do not connect the CATx link interface (RJ45 style connector) to any other equipment, particularly network or telecommunications equipment.
- Warning – the power adapter contains live parts.
- No user serviceable parts are contained within the power adapter - do not dismantle.
- Plug the power adapter into a socket outlet close to the AdderLink unit that it is powering.
- Replace the power adapter with a manufacturer approved type only.
- Do not use the power adapter if the power adapter case becomes damaged, cracked or broken or if you suspect that it is not operating properly.
- If you use a power extension cord with the extenders, make sure the total ampere rating of the devices plugged into the extension cord do not exceed the cord's ampere rating. Also, make sure that the total ampere rating of all the devices plugged into the wall outlet does not exceed the wall outlet's ampere rating.
- Do not attempt to service the X2 modules yourself.
- The X2 modules and power supplies can get warm in operation – do not situate them in an enclosed space without any ventilation.
- The X2 modules do not provide ground isolation and should not be used for any applications that require ground isolation or galvanic isolation.

Warranty

Adder Technology Ltd warrants that this product shall be free from defects in workmanship and materials for a period of two years from the date of original purchase. If the product should fail to operate correctly in normal use during the warranty period, Adder will replace or repair it free of charge. No liability can be accepted for damage due to misuse or circumstances outside Adder's control. Also Adder will not be responsible for any loss, damage or injury arising directly or indirectly from the use of this product. Adder's total liability under the terms of this warranty shall in all circumstances be limited to the replacement value of this product. If any difficulty is experienced in the installation or use of this product that you are unable to resolve, please contact your supplier.



CONTENTS

WELCOME

INSTALLATION
& OPERATION

SPECIAL
CONFIGURATION

FURTHER
INFORMATION

Emissions and Immunity

A Category 5 (or better) twisted pair cable must be used to connect the X2 modules in order to maintain compliance with radio frequency energy emission regulations and ensure a suitably high level of immunity to electromagnetic disturbances.

All other interface cables used with this equipment must be shielded in order to maintain compliance with radio frequency energy emission regulations and ensure a suitably high level of immunity to electromagnetic disturbances.

The extender does not provide any extra error checking on the RS232 serial port signals and so to ensure a suitably high level of immunity in electrically noisy installations, an RS232 protocol with bit error correction or a shielded CATx cable should be used.

European EMC directive 89/336/EEC



This equipment has been tested and found to comply with the limits for a class A computing device in accordance with the specifications in the European standard EN55022. These limits are designed to provide reasonable protection against harmful interference. This equipment generates, uses and can

radiate radio frequency energy and if not installed and used in accordance with the instructions may cause harmful interference to radio or television reception. However, there is no guarantee that harmful interference will not occur in a particular installation. If this equipment does cause interference to radio or television reception, which can be determined by turning the equipment on and off, the user is encouraged to correct the interference with one or more of the following measures: (a) Reorient or relocate the receiving antenna. (b) Increase the separation between the equipment and the receiver. (c) Connect the equipment to an outlet on a circuit different from that to which the receiver is connected. (d) Consult the supplier or an experienced radio/TV technician for help.

FCC Compliance Statement (United States)

This equipment generates, uses and can radiate radio frequency energy and if not installed and used properly, that is, in strict accordance with the manufacturer's instructions, may cause interference to radio communication. It has been tested and found to comply with the limits for a class A computing device in accordance with the specifications in Subpart J of part 15 of FCC rules, which are designed to provide reasonable protection against such interference when the equipment is operated in a commercial environment. Operation of this equipment in a residential area may cause interference, in which case the user at his own expense will be required to take whatever measures may be necessary to correct the interference. Changes or modifications not expressly approved by the manufacturer could void the user's authority to operate the equipment.

Canadian Department of Communications RFI statement

This equipment does not exceed the class A limits for radio noise emissions from digital apparatus set out in the radio interference regulations of the Canadian Department of Communications.

Le présent appareil numérique n'émet pas de bruits radioélectriques dépassant les limites applicables aux appareils numériques de la classe A prescrites dans le règlement sur le brouillage radioélectriques publié par le ministère des Communications du Canada.



CONTENTS

WELCOME

INSTALLATION
& OPERATION

SPECIAL
CONFIGURATION

FURTHER
INFORMATION

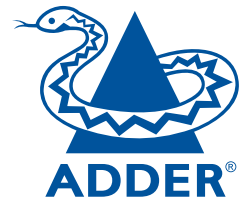

Web: www.adder.com

Contact: www.adder.com/contact-details

Support: forum.adder.com

CONTENTS

WELCOME

INSTALLATION
& OPERATION

SPECIAL
CONFIGURATION

FURTHER
INFORMATION