

ROI Series Mini-Converter

HDMI, DP, DVI to SDI Scalers

Installation & Operation Guide

Version 1.3

Published: April 11, 2016



Because it matters.®

AJA
VIDEO SYSTEMS

Table of Contents

Notices	3
Trademarks	3
Copyright	3
Contacting Support	3
Chapter 1: Introduction	4
Overview	4
Features	5
ROI-HDMI	5
ROI-DP	5
ROI-DVI	5
All ROI Models	5
Pixel Clock Rate	5
Exceeds Max Rate Notification	5
Mini-Config Overview	6
Simplified Block Diagram	6
I/O Connections	6
ROI-HDMI	6
ROI-DP	7
ROI-DVI	8
All ROI Models	8
Typical ROI Configurations	8
Installation	11
Chapter 2: Operation	12
USB Control and Setup—Using AJA Mini-Config	12
Acquiring Mini-Config	12
Mini-Converter Documentation	12
Installing Mini-Config	12
PC Installation	12
Mac Installation	13
Running Mini-Config	14
PC Startup	14
Mac Startup	14
Saving Setups	15
Operating Mini-Config	15
Running Multiple Mini-Converters	15
Tabbed Screens	16
Input Screen	17
Click and Drag Options	18
Screen Picker Operation	19
Output Screen	20
About the Rotation, Flip, and Frame Delay Controls	22
Monitor Matrix Screen	24
Genlock Screen	25
Audio Screen	27
Update Screen	29
Info Tab Screen	30
Appendix A: Specifications	31
Video Input	31

Input Formats.....	31
Input Data Range Control	31
Reference Input	31
Genlock.....	31
Video Processing	32
Frame Rate Conversion.....	32
Output Video Delay	32
Video Output	32
Output Formats.....	32
Audio Input	32
Audio Output	32
User Controls.....	32
Physical.....	33
Appendix B: Safety & Compliance	34
Federal Communications Commission (FCC) Compliance Notices	34
Class A Interference Statement	34
FCC Caution	34
Canadian ICES Statement.....	34
European Union and European Free Trade Association (EFTA)	
Regulatory Compliance.....	35
Declaration of Conformity.....	35
Recycling Notice	36
Korean KCC Compliance Statement	36
Taiwan Compliance Statement	36
Japanese Compliance Statement	36
Translated Warning and Caution Messages.....	37
Before Operation Please Read These Instructions	37
Warranty Information	43
Limited Warranty.....	43
Index.....	1

Notices

Trademarks

AJA® and Because it matters.® are registered trademarks of AJA Video Systems, Inc. for use with most AJA products. AJA™ is a trademark of AJA Video Systems, Inc. for use with recorder, router, software and camera products. Because it matters.™ is a trademark of AJA Video Systems, Inc. for use with camera products.

CION®, Corvid Ultra®, Io®, Ki Pro®, KONA®, KUMO®, ROI® and T-Tap® are registered trademarks of AJA Video Systems, Inc.

AJA Control Room™, FiDO™, KiStor™, Science of the Beautiful™, TruScale™, TruZoom™, V2Analog™ and V2Digital™ are trademarks of AJA Video Systems, Inc.

AirPort, Apple, Apple logo, AppleShare, AppleTalk, FireWire, iPod, iPod touch, Mac, Macintosh and ProRes, are registered trademarks of Apple Inc. Final Cut Pro, QuickTime and QuickTime logo are trademarks of Apple Inc.

Avid, Avid DNxHD and Media Composer are registered trademarks of Avid Technology, Inc.

Adobe is a registered trademark of Adobe Systems Incorporated in the United States and/or other countries.

HDMI, the HDMI logo and High-Definition Multimedia Interface are trademarks or registered trademarks of HDMI Licensing, LLC.

DVI is a registered trademark of DDWG.

TASCAM is a registered trademark of TEAC Corporation.

Dolby and the double-D Dolby logo are registered trademarks of Dolby Laboratories Licensing Corporation.

All other trademarks are the property of their respective holders.

Copyright

Copyright © 2016 AJA Video Systems, Inc. All rights reserved. All information in this manual is subject to change without notice. No part of the document may be reproduced or transmitted in any form, or by any means, electronic or mechanical, including photocopying or recording, without the express written permission of AJA Video Systems, Inc.

Contacting Support

When calling for support, have all information at hand prior to calling. To contact AJA for sales or support, use any of the following methods:

Telephone: +1.530.271.3190

FAX: +1.530.271.3140

Web: <http://www.aja.com>

Support Email: support@aja.com

Sales Email: sales@aja.com

Chapter 1: Introduction



Overview

AJA's ROI (region of interest) scaling converters can be used out-of-the-box to convert either HDMI, DisplayPort (DP), or DVI input signals (depending on model) to SDI output. The three models available are ROI-HDMI, ROI-DP, and ROI-DVI. In default mode, each ROI converter automatically detects the input signal format and converts it to the SDI output video format. In this startup Auto mode, the full-size input is output to the SDI output. The picture's aspect ratio is maintained and if the SDI monitor is larger than the input signal, unused area is filled with matte color. Default audio setup passes 8-channels of embedded audio (if present).

To realize the full power of ROI, however, you will use the supplied USB cable and AJA's Mini-Config application to select the desired SDI output format and perform a host of region-of-interest and output display scaling operations.

- Audio Handling** Analog audio from the host can be input via a standard 3.5mm audio cable and mapped to the embedded SDI output stream. Alternatively, if the input is HDMI or DP, its embedded audio can be the audio input. The ROI-DVI model can receive both DVI and HDMI protocol input, and accepts audio if it is embedded in an HDMI signal. However, the DVI protocol does not carry audio, so if the ROI-DVI is receiving DVI input, only analog audio can be embedded to the output.
- Control Interface** For control, the ROI is connected to a computer via USB. The ROI has no local, physical user-interface (no dipswitch settings). The ROI can operate stand-alone without a USB connection to the host. In this mode, the ROI automatically adapts to the input signal, and operates according to defaults or as last configured via the AJA Mini-Config application (see ["Operation" on page 12](#)).
- HDCP Protection** The ROI honors HDCP, and will not allow an HDCP link. If the input content is HDCP protected, no source video will be displayed on the ROI's DVI pass-through connector, or on the ROI's SDI output.

Features

ROI-HDMI • Convert HDMI input to 3G, HD, or SD-SDI output

ROI-DP • Convert DisplayPort input to 3G, HD, or SD-SDI output

ROI-DVI • Convert DVI input to 3G, HD, or SD-SDI output

- All ROI Models**
- User-adjustable “region of interest”
 - 4:3/16:9 conversion modes supported
 - Setup via PC/Mac using Mini-Config software with the USB port and supplied USB cable
 - Frame-rate conversion
 - Automatic configuration to input video raster and frame rate
 - SDI output configurable to most common SD and HD formats (1080p60 max)
 - Edge filtering control
 - Rotation, Horizontal and Vertical flip controls
 - Monitor Matrix setup controls
 - Frame delay control
 - Genlock and frame sync with reference input
 - Adjustable Horizontal and Vertical video delay from sync input
 - Audio input via 3.5mm 2-channel analog input or 8-channel embedded (if present)
 - Embedded SDI audio out (up to 8 channels)
 - Uses universal input +5V power supply AJA model DWP-U-R1 (included)
 - 5-year warranty

NOTE: Pixel rates are limited by to a 165MHz maximum rate.

Pixel Clock Rate

Some sources can generate pixel clock rates that exceed the capabilities of the ROI converter. The pixel clock is a combination of the video resolution and its vertical rate. It may not be obvious what the resulting pixel clock will be for a particular resolution or vertical rate.

Exceeds Max Rate Notification

If the incoming video's pixel clock rate is too high, the ROI converter will generate a full screen red matte on the SDI output to indicate this error condition. Mini-Config will also display an “*exceeds max rate*” error message. A downstream HDMI/DP/DVI monitor will still display the incoming video, however.

When a downstream sink device is connected to the ROI output monitor connector, the source and sink could potentially negotiate a display format (using EDID) that is beyond the capability of ROI's video processing circuitry, resulting in the red matte SDI output. Possible solutions include:

- Disconnect the downstream device (for example, a computer monitor) from the ROI. Once disconnected, ROI will negotiate directly with the source to generate a video resolution that it within the ROI's processing capability. With this solution, the downstream device will lose its signal, but the SDI output will work as expected.
- Reconfigure the source signal to a different resolution or scan rate. An alternative setting may permit both valid SDI output and the signal on a downstream monitor.
- On ROI-DP models, use the EDID Flow Through control (see [page 26](#)).

Mini-Config Overview

Using AJA's Mini-Config application, you can set up and control region-of-interest and output display scaling operations, route audio, and configure genlock. Mini-Config is also used to update the Mini-Converter firmware.

Simplified Block Diagram

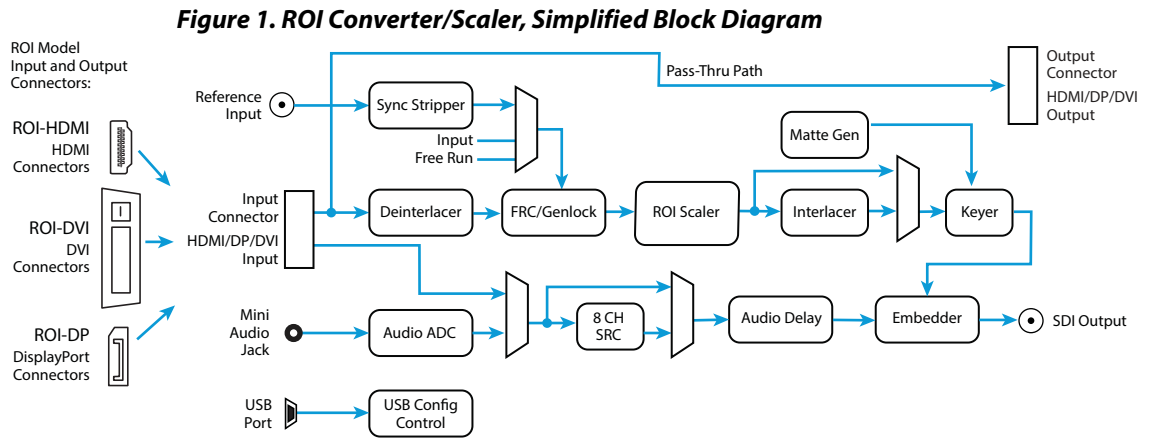

I/O Connections

ROI-HDMI

Figure 2. ROI-HDMI Converter/Scaler



HDMI Input: Connects to your computer or single-link source device.

To connect a DVI video input to the ROI HDMI input connector, use a passive DVI-to-HDMI adapter (user-supplied). You can also use a cable adapter that has a DVI connector on one end of the cable and an HDMI connector on the other.

HDMI Output: This is a pass-through output for use on a second computer monitor for using the AJA Screen Picker feature (described on [page 19](#)). Connections are the same as described for DVI/HDMI input above.

ROI-DP

Figure 3. ROI-DP Converter/Scaler

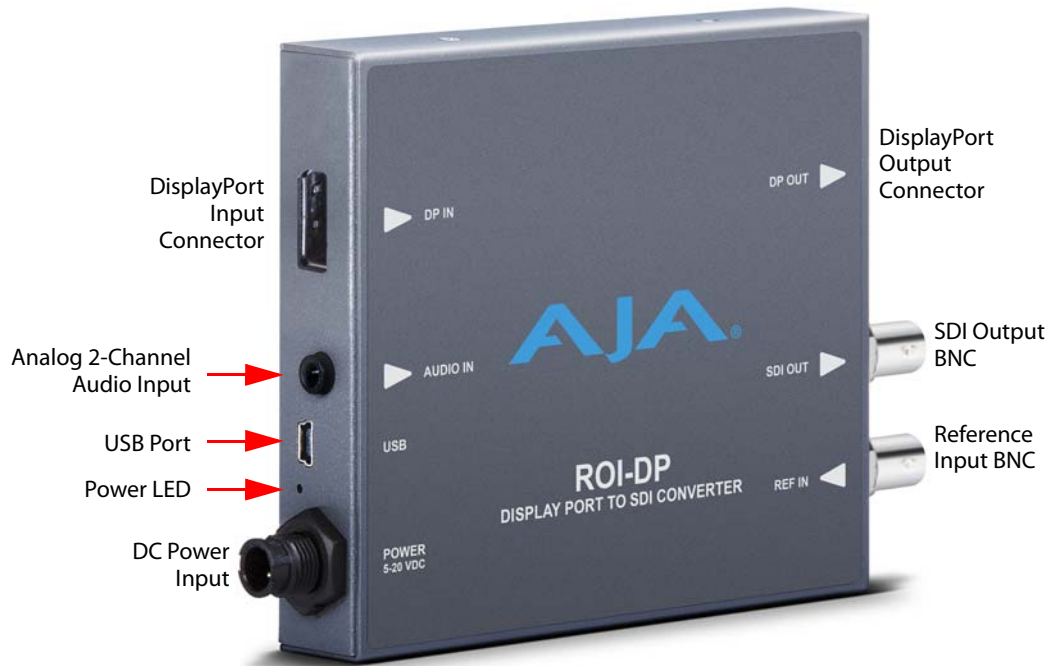

DisplayPort Input: Connects to your Computer or single-link source device.

DisplayPort Output: This is a pass-through output for use on a second computer monitor for using Screen Picker. Connections are the same as described for DisplayPort input above.

ROI-DVI

Figure 4. ROI-DVI Converter/Scaler

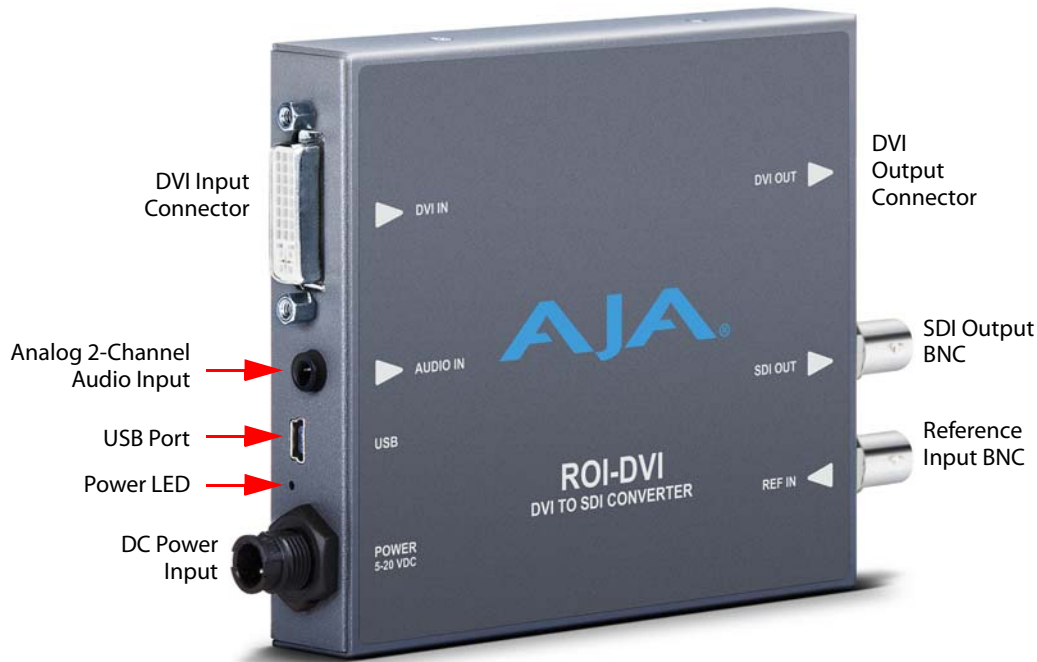

DVI Input: Connects to your Computer or single-link source device.

To connect an HDMI video input to the ROI DVI input connector, use a passive HDMI-to-DVI adapter (user-supplied). You can also use a cable adapter that has an HDMI connector on one end of the cable and a DVI connector on the other.

DVI Output: This is a pass-through output for use on a second computer monitor for using Screen Picker. Connections are the same as described for DVI/HDMI input above.

All ROI Models

Analog Audio: A single 3.5 mm analog audio connector accepts two channels of analog audio which can be embedded into the SDI output as determined by the audio configuration set using Mini-Config.

USB Port: Accepts USB mini connector

SDI Video Output: Standard BNC connector for coaxial SDI monitor connection.

Reference Video Input: The Reference BNC accepts an Output timing reference signal. The reference can be SD Blackburst or HD tri-level sync.

Typical ROI Configurations

Two typical configurations for using the ROI for scaling of desktop region-of-interest computer sourced video are illustrated in the following figures. In these configurations, the pass-through monitor is used to view the subject desktop video and use the Mini-Config application's Screen Picker function to select the desired region for output to SDI (see "[Screen Picker Operation](#)" on page 19).

Figure 5. ROI with Laptop Computer, System Interconnect Diagram

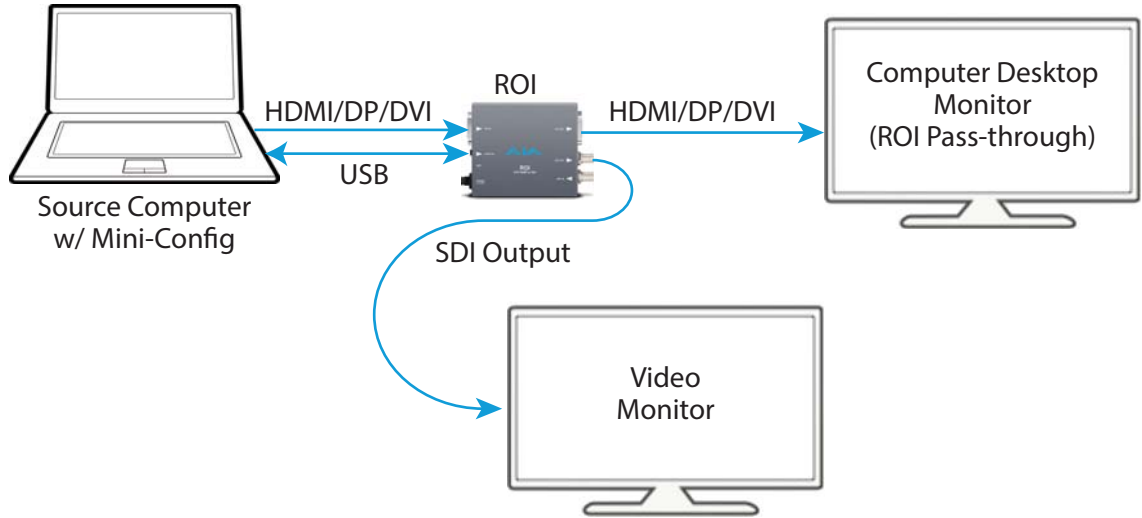
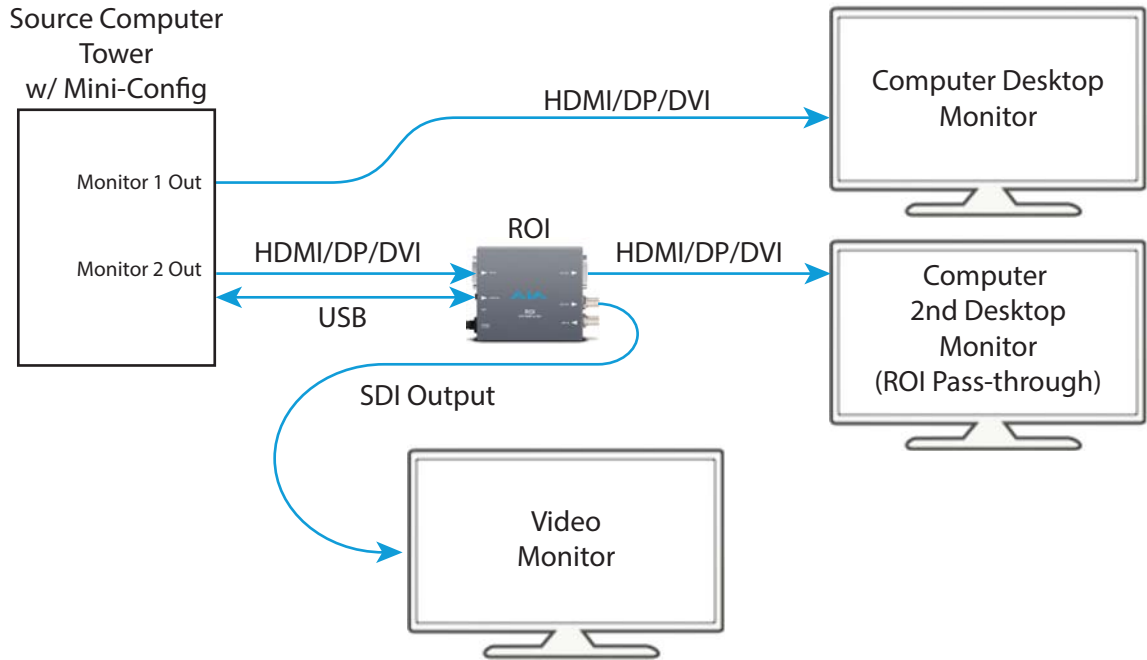
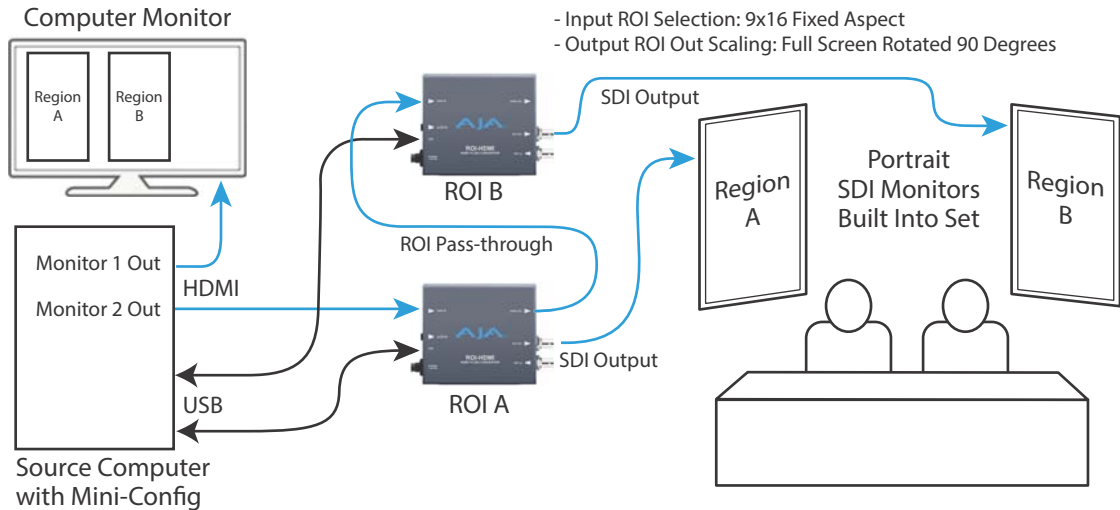

Figure 6. ROI with Tower Computer & Two Monitors, System Interconnect Diagram



A third example illustrates use of the ROI Rotation feature to send selected areas of a computer graphic to portrait mounted on-set monitors at full resolution. Each monitor uses one ROI converter, accomplishing the task at a much lower cost than dedicating DVE channels for rotation and resizing. This wiring example will work provided the HDMI cables are short. An HDMI splitter/amplifier can be used if the ROIs need to be located farther away from the computer (Figure 7).

Figure 7. ROI Rotation with Portrait Mounted On-Set Monitors



A fourth example below illustrates sending HDMI digital video from a camera to a ROI to allow region of interest video input to a video switcher. The Screen Picker feature cannot be used in this configuration (Figure 8).

Figure 8. ROI with Video Camera to Switcher Interconnect Diagram

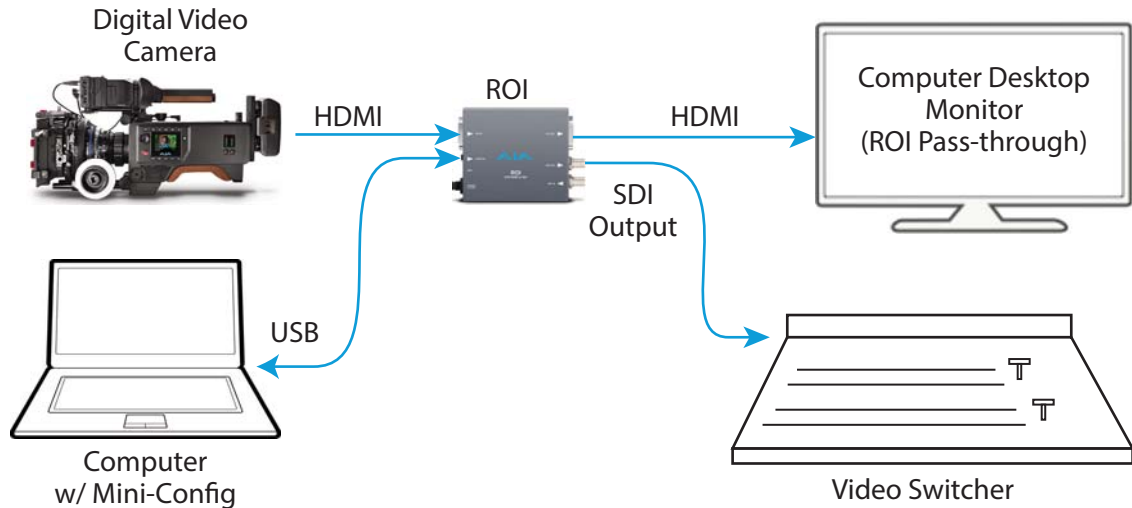

Installation

Typically, ROI installation consists of the following steps:

1. Ensure the ROI is disconnected from power.
2. Connect your computer or video console monitor output to the ROI's HDMI/DVI/DP input connector.
3. Connect the ROI's HDMI/DVI/DP output connector to a second computer monitor (optional).
4. Connect video monitor to the converter SDI output BNC.
5. Connect two-channel analog audio input to analog audio connector (optional)
6. Apply power to the converter (AJA power supply included).
7. The converter will now run using the default factory settings. If you wish to alter the factory settings, you'll need to:
 - Install the AJA Mini-Config software onto your computer.
 - Attach the converter via USB cable (included).
 - Make your changes using Mini-Config setup screens.

Chapter 2: Operation

IMPORTANT: Once the ROI has been configured with Mini-Config, those settings will continue to be used in stand-alone mode (disconnected from USB) as long as the input format remains the same. If a different input format is connected, the ROI will revert to Auto mode. However, if the original input format is re-connected, the ROI will exit Auto mode and restore the previously configured settings for that format.

USB Control and Setup—Using AJA Mini-Config

Your AJA Mini-Converter can be used right out of the box for some applications since it is designed to recognize inputs and perform standard actions automatically by default. However, to use its full capability, you must use AJA's Mini-Config software application for PCs and Macs. This same application can be used to update to new Mini-Converter software released by AJA.

Acquiring Mini-Config

AJA's Mini-Config application is available for download from the AJA website.

To download the latest Mini-Config package, which includes the Mini-Config application, Mini-Converter firmware, and documentation, go to:

<https://www.aja.com/en/products/mini-converters/mini-config-software>

Select either the Windows or Mac icon to download the desired version.

Mini-Converter Documentation

Included with the Mini-Config package is a complete set of documentation for all Mini-Converters supported by Mini-Config. A .PDF of the *Installation and Operation Guide* for the currently connected Mini-Converter can be accessed from the Mini-Config UI via the **Help/Manual** drop-down menu.

Documentation for all AJA Mini-Converters that use Mini-Config can also be accessed directly in the Mini-Config download package Documentation folder, and via the Documentation icon available on the Mac installer.

Documentation (and firmware) included with the Mini-Config application are the versions available at the time of distribution. However, Mini-Converter software, firmware and documentation are updated regularly, so newer versions may exist.

To download the latest documentation for an individual Mini-Converter, go to:

<https://www.aja.com/en/category/mini-converters>

and navigate to the Support webpage of that Mini-Converter.

Installing Mini-Config

PC Installation To install Mini-Config on a Windows PC:

1. Download the application from the AJA website (select the Windows icon on the Mini-Config Support webpage).
2. Open the AJA_MiniConfig.zip file
3. Double-click on the MiniInstaller.msi file.

4. A Setup Wizard will guide you through the installation.

Figure 9. Mini-Config PC Setup Wizard



5. Click **Next** to begin. Answer the questions in the subsequent dialogues. When finished, an AJA Mini-Config shortcut will be installed on the desktop, and you will be able to locate the Mini-Config application in the AJA folder in the Programs listing.

NOTE: If the Mini-Config application already exists on the PC, a different Setup Wizard appears.

Figure 10. Mini-Config Setup Wizard, Reinstallation

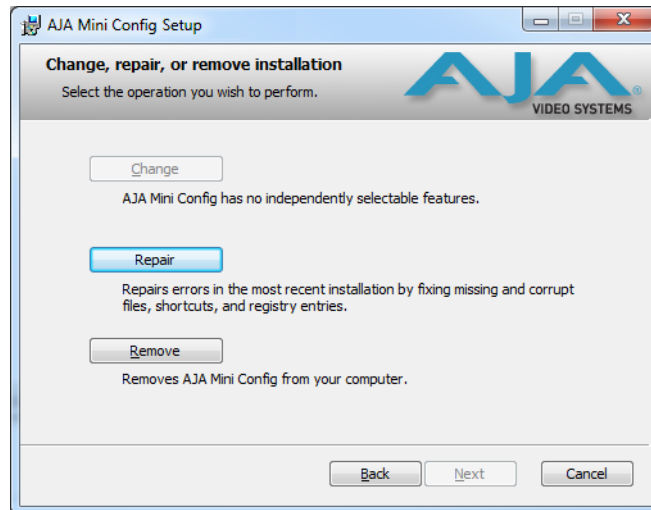

With this screen you can **Repair** (reinstall) or **Remove** (uninstall) Mini-Config on the PC.

Mac Installation To install the application on a Mac:

NOTE: Macintosh computers must be Intel-based (G5, G4 and earlier models will not work with Mini-Config).

1. Download the application from the AJA website (select the Apple icon on the Mini-Config Support webpage).
2. Open the AJA_MiniConfig folder.
3. Double-click on the AJAMiniConfig.dmg file.

4. Answer the prompt and a utility program will be launched.

Figure 11. Mini-Config Mac Installer

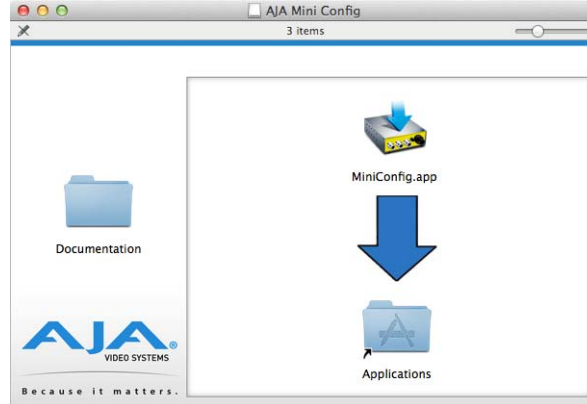

5. To complete the installation drag the “MiniConfig.app” icon to the Applications folder.

Running Mini-Config

Connect the Mini-Converter to the PC or Mac via the supplied USB cable. Connect the external power supply (supplied) to the Mini-Converter.

PC Startup

To run Mini-Config on a PC, double-click on the AJA Mini-Config icon on your desktop, or open the AJA folder in the program list and click on the AJA Mini-Config application located inside the Mini-Config folder.

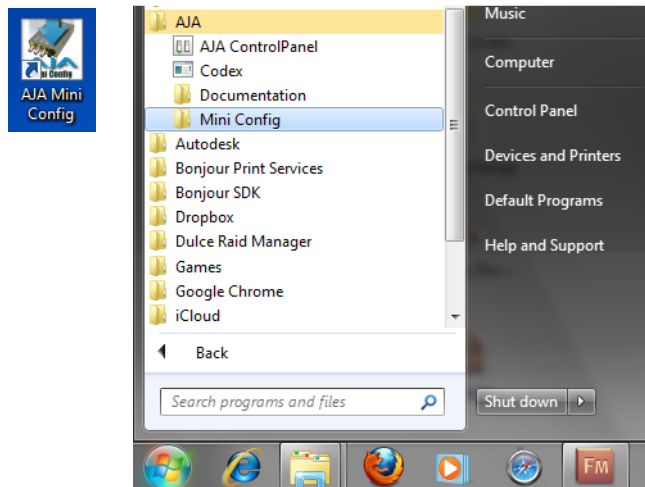

Mac Startup

To run Mini-Config on a Mac, open the Applications folder and locate the AJA Mini-Config application. Double-click the application to launch it.

Saving Setups A **File** drop down menu on the Mini-Config application bar allows you to save the current state of the Mini-Converter to a preset file for later recall.

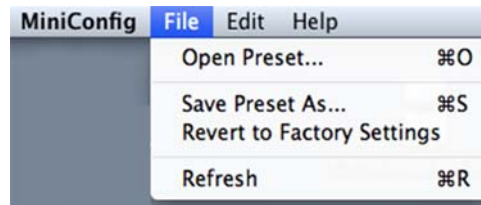

Using this feature you can set up the converter for different applications, storing each configuration (**Save Preset As...**) with a unique name for easy recall (**Open Preset...**).

A **Revert to Factory Settings** menu item similarly allows you to change the settings back to AJA's factory defaults.

Operating Mini-Config

The Mini-Config application provides a graphic interface for viewing settings and updating software. It consists of an information area at the top that shows the available Mini-Converters attached to the computer via USB, with a graphical rendering of the selected Mini-Converter showing all the connectors and their current state.

Colored text next to the connectors indicates the signal type and what the Mini-Converter is doing:

- Blue text indicates the values automatically selected
- Black text indicates values that you have manually selected
- Red text indicates the Mini-Converter is not detecting a signal, or cannot operate with the current user settings.

NOTE: Even if no output device is detected, the SDI connector text still shows the signal it is outputting.

NOTE: Configuration settings in red will change based on the attached output device as well as input signals. For improved accuracy and reliability, you should configure the Mini-Converter only when the target output device is attached and input signals are supplied at the inputs.

Screens are virtually the same on both PC and Mac, with subtle differences that reflect the general look of the platform environment.

Running Multiple Mini-Converters

Mini-Config can manage multiple AJA Mini-Converters connected via USB—even when they are of differing types. However it only connects to one at a time. You can choose which Mini-Converter you wish to control using the pulldown menu in the upper right hand corner. If you want to configure multiple Mini-Converters in parallel, you can do it by running multiple instances of the Mini-Config application and have each control a different Mini-Converter.

NOTE: During a Mini-Converter firmware update, only one Mini-Converter should be connected to the computer via USB.

Figure 12. Example Mini-Config Screen

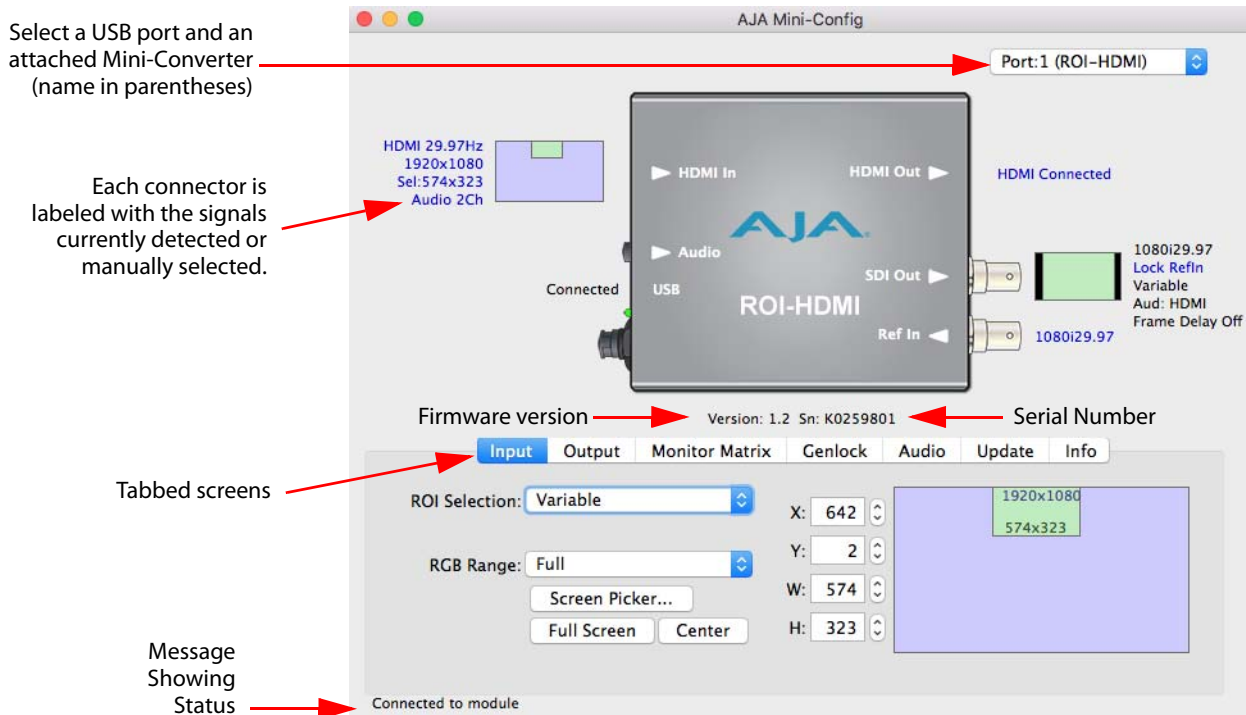

Selecting a Mini-Converter with the pulldown menu causes this application to connect to the selected converter. The graphic of Mini-Converter and text below it provides:

- Type of converter
- Firmware version
- Serial number of the unit.

A status field at the bottom of the screen shows if your application is connected and communicating with the Mini-Converter.

When configuring the Mini-Converter, select it from the top pulldown, view the current settings and change any values. Making a change communicates that new value to the Mini-Converter's non-volatile memory.

Tabbed Screens

The Tabs delineate control screens with groups of controls for each type of task to be performed.

The controls for the actual configuration parameters are specific to each Mini-Converter type. When you Click on any of the tab buttons, the pane below the tabs will change to match your tab selection. Any changes you make are immediately applied and will be saved, overwriting previous settings.

NOTE: In this manual Mini-Config screens for the ROI-HDMI model are shown. Other ROI models have similar screens, with a few exceptions that are noted.

Input Screen

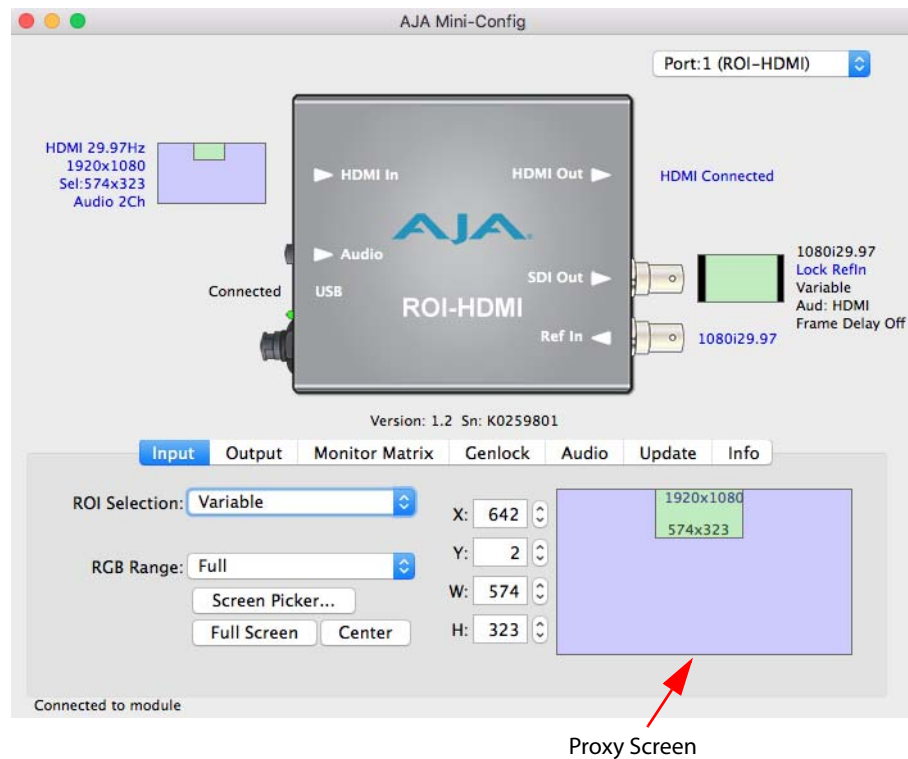

Click on the Input tab to view and make changes to the converter's input region-of-interest settings.

The Proxy Screen on the lower right shows the current region of interest setting in green with the selection pixel size at the bottom and the input pixel size at the top.

Various controls are also available on the left.

NOTE: *The adjustments made on the green proxy screens and Screen Picker are live and can be viewed on the SDI output.*

NOTE: *Portions of this screen are grayed out if no input signal is present.*

ROI Selection Using this pulldown menu you can choose a selection mode:

NOTE: *Mini-Config provides a Tool-tip description for each ROI Selection mode. Hover your cursor over the mode name in the drop-down menu for a description of its function.*

- Auto - Selects the entire signal detected at the input to the ROI (default setting). Scales the input region-of-interest as large as possible to fit into the SDI output region while maintaining the incoming aspect ratio. Matte may result if the input's aspect ratio does not match the SDI out aspect ratio.

NOTE: *Auto selections in the Input screen and the Output screen are linked. Selecting Auto from one screen will also select Auto in the other screen.*

- Variable - Allows user-adjustable selection of all or a portion of the input signal. When you select *Variable* as the selection type, you can choose the region-of-interest selection in three ways with no constraints:

- Use the X,Y coordinate and W,H (width, height) size fields. Within these fields, you can enter values (if they are valid) or use your keyboard arrow keys to increment one pixel/line at a time for fine adjustment.
- If configuring a multiple monitor matrix, you can use the Monitor Matrix screen to select the ROI and, when applied, will fill the X, Y, W, and H fields with the correct values. See [“Monitor Matrix Screen” on page 24.](#)
- Drag the edges of the image representation (green proxy screen) at the right of the selection pane. See [“Click and Drag Options” on page 18.](#)
- Use the Screen Picker button to produce a full-sized image with highlighted crop boundary box in the pass through monitor. See [“Screen Picker Operation” on page 19.](#)

NOTE: For Screen Picker operation, the resolution of the pass-through monitor Mini-Config is using must match the resolution of the input to the ROI.

- Fixed Aspect - Opens a ROI Fixed Aspect drop-down menu allowing fixed aspect input region-of-interest selection. In this mode, the size of the selected region-of-interest can change but the aspect ratio is held constant:
 - 4:3 (SD aspect ratio)
 - 16:9 (HD aspect ratio)
 - 3:4 (useful for presentation on vertically oriented monitors)
 - 9:16 (useful for presentation on vertically oriented monitors)
- Fixed Size - Opens a ROI Fixed Size drop-down menu allowing fixed size input region-of-interest selection. In this mode, the region-of-interest selection can change position on the input screen but the size cannot be changed. These settings allow you to easily select standard video sizes for region-of-interest.
 - DV
 - NTSC
 - PAL
 - 720HD
 - 1080HD
- SDI Out - Forces the region-of-interest to have the same aspect ratio as the current *SDI Out Format* setting.

RGB Range Menu The RGB Range pulldown menu allows you to select either Full range (0-1023) or SMPTE range (typically 64-940) for RGB color input.

Full Screen Button Click the Full Screen button to quickly set the region-of-interest to the full input raster size.

Center Button If you choose anything other than a full-sized image (Auto) in the ROI *Select* menu, you will have complete control of where the region of interest selection is placed. To quickly and precisely center the region-of-interest, click the Center button.

Click and Drag Options

When using the drag method for region-of-interest placement or resizing, you can use the Option/ALT, Shift, and Arrow keys for precise adjustments.

Option/ALT key: For more control, hold down the Option/ALT key while dragging the image boundary. You will notice that the selection changes in a more gradual pixel-by-pixel manner regardless of your drag speed.

Shift key: You may change the image size while maintaining the current aspect ratio, by holding down the Shift key as you drag.

Arrow Keys: You can use the keyboard arrows to increment size and placement of a variable region-of-interest selection one pixel at a time in X,Y,H,W fields and in the proxy and Screen Picker screens. (The up/down arrow keys can also be used to step through some menu selections.)

Screen Picker Operation

When Variable region-of-interest selection is enabled, pressing the Screen Picker button activates Screen Picker mode. A full-sized image with highlighted crop boundary box is displayed in the pass through monitor (refer to [“Typical ROI Configurations” on page 8](#)). Adjust the region-of-interest boundaries by dragging the image sized to the desired locations, and then press the Enter or Return key to exit Screen Picker mode.

NOTE: For Screen Picker operation, the source video must be coming from the same PC that is running Mini-Config, and the resolution of the pass-through monitor Mini-Config is using must match the resolution of the input to the ROI.

Figure 13. Screen Picker Cropping Overlay

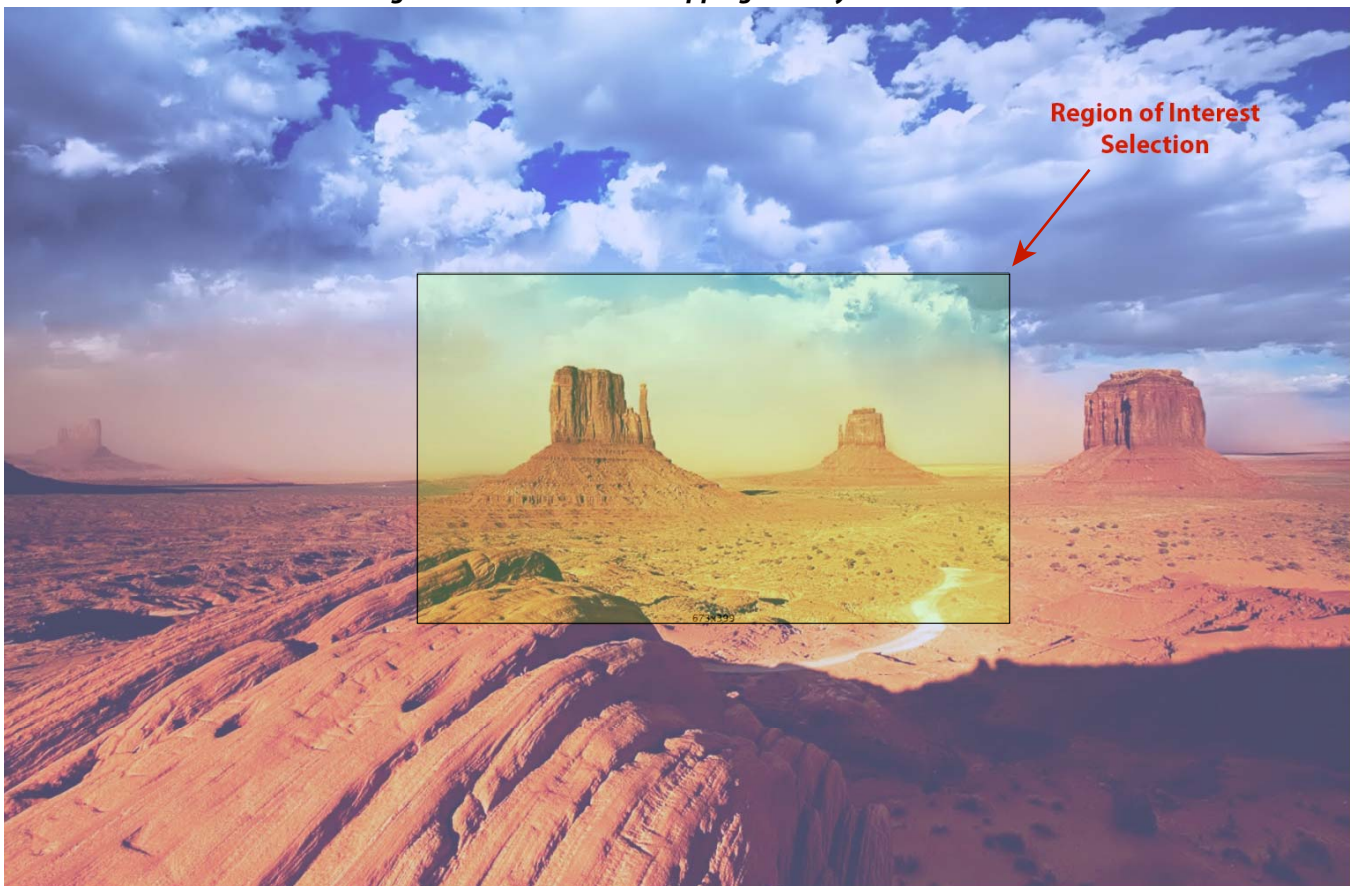

Output Screen

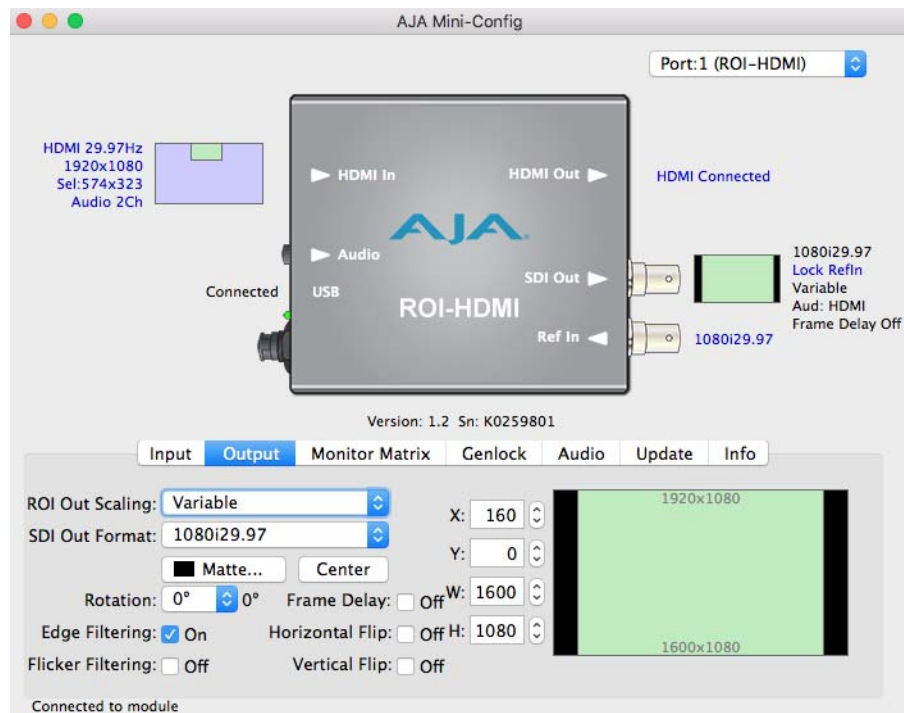

Click on the Output Tab to adjust the following parameters.

NOTE: Portions of this screen are grayed out if no input signal is present.

NOTE: Some sources can generate pixel clock rates that exceed the capabilities of the ROI. If the incoming video's pixel clock rate is too high, the ROI converter will generate a full screen red matte on the SDI output to indicate this error condition. Mini-Config will also display an "Exceeds max rate" error message. A downstream HDMI/DP/DVI monitor will still display the incoming video. See page 5 for potential solutions.

ROI Out Scaling Use the ROI Out Scaling pulldown menu to select one of the following:

NOTE: Mini-Config provides a Tool-tip description for each ROI Out Scaling mode. Hover your cursor over the mode name in the drop-down menu for a description of its function.

- Auto - Automatically scales region-of-interest to maximum size with fixed aspect ratio defined by input format (default setting).

NOTE: Auto selections in the Output screen and the Input screen are linked. Selecting Auto from one screen will also select Auto in the other screen.

- Fixed Aspect - Matte - Scales region-of-interest to maximum size to fit output region while maintaining aspect ratio. Matting may occur if input aspect ratio does not match output aspect ratio.
- Full Screen - Scales region-of-interest to maximum size to fit output geometry. This may change aspect ratio of the image. No matting will occur.
- None - Crop/Matte - No scaling occurs to region-of-interest. It is always centered on the output, and the area displayed is selected using the placement controls in the Input menu.
- Variable - Allows user to arbitrarily change position and scaling of region-of-interest as it is placed into the output region.

- SDI Output Format** The pulldown menu offers a full range of SDI Video Formats for output. For the complete list, see [“Output Formats” on page 32](#). The format selection is reported in the Mini-Config graphic depicting the SDI Output.
- Matte Background** Click the Matte button to pull up the matte color panel that offers various modes of background color selection.

Figure 14. Matte Color Selection Panel

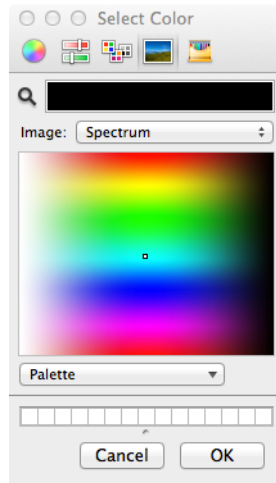

- Center Button** After a screen region-of-interest has been defined, click the Center button to quickly center the image.
- Edge Filtering Button** You can disable edge filtering with this control. This is useful if you are using four ROIs to drive a 4K monitor matrix. Disabling edge filtering can eliminate the vertical and horizontal lines that would occur in that situation. Default setting is On.
- Flicker Filtering Button** You can enable flicker filtering with this control. This can be useful where vertical detail (horizontal lines) may strobe with the refresh rate of the display. Flicker filtering can help with interlaced outputs, and when a detailed image is scaled down into a smaller area. Default setting is Off.

NOTE: The following Rotation, Frame Delay, and Flip controls interact with each other. If the ROI's video processing circuit is unable to perform the processing, the actual Off state of each control is reported in red. See [“About the Rotation, Flip, and Frame Delay Controls” on page 22](#) for more information.

- Rotation** Opens a drop down menu for selecting of a clockwise rotation setting (see [Figure 15](#)):
- 0° (no rotation, default setting)
 - 90°
 - 180°
 - 270°

- Frame Delay** Turns Frame Delay On or Off. One frame of delay is automatically applied whenever Rotate or Flip is active. The current frame delay state (On or Off) is reported.

NOTE: Turning Frame Delay On can be useful if you are using two ROIs simultaneously, flipping or rotating only one of their outputs. Because a frame delay is always applied to the flipped or rotated output, turning on the other ROI's Frame Delay restores their relative timing.

- Horizontal Flip** Flips the output horizontally (left to right, and right to left, see [Figure 15](#)).

Vertical Flip Flips the output vertically (top to bottom and bottom to top, see [Figure 15](#)).

Figure 15. Flip and Rotation Illustration

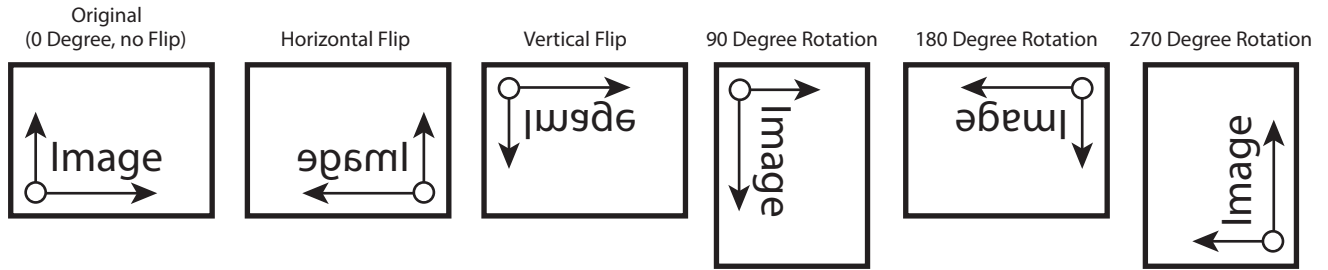

About the Rotation, Flip, and Frame Delay Controls

Rotation and Flip image processing can be intensive, and requires one frame of video delay. Whenever a rotation or flip occurs a frame delay is automatically applied, and the Frame Delay On status is reported, even if the checkbox isn't selected ([Figure 16](#)).

Figure 16. Frame Delay Automatically On with Rotation

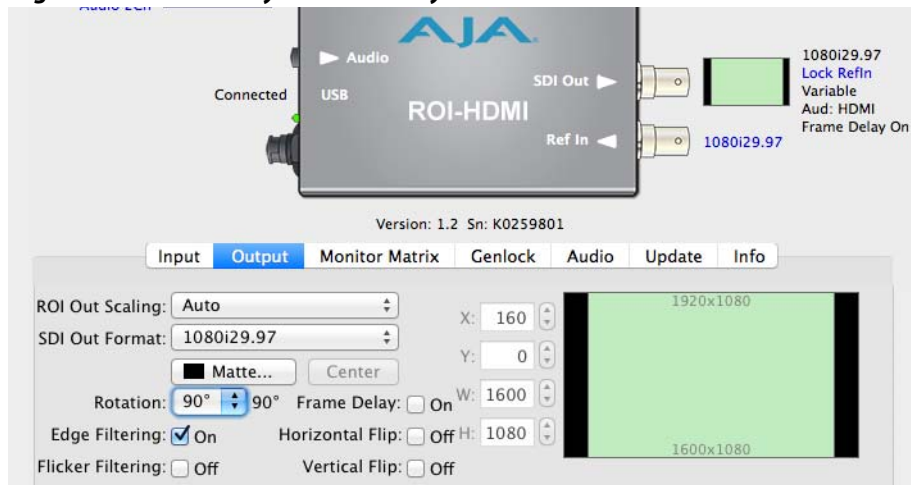

The Rotation, Flip, and Delay controls all report their current statuses. Some specific combinations of input and output selections and 180° rotations or flips involving 1920x1080i input video can exceed the processing capacity of the ROI Mini-Converter. In these unusual cases, a Processing Limit Exceeded red error message is displayed on the UI, and the actual current settings for Rotation, Frame Delay, and Flip are reported in red (Figure 17).

Figure 17. Processing Limit Exceeded

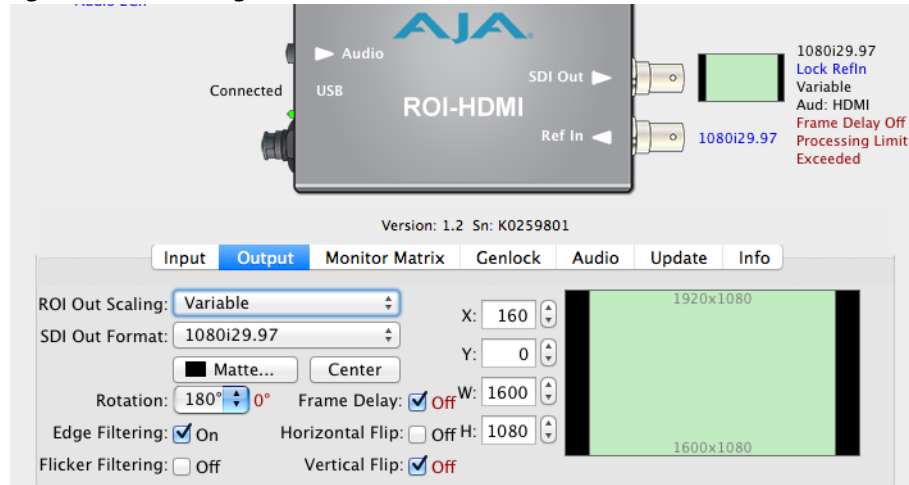

Possible work-a-rounds for this error condition include:

- Select an input source format that is not 1920x1080i.
- Reduce the size of the input or output region of interest.
- Select 90° or 270° Rotation.
- Turn off frame delay (if 180° Rotation, H flip and V flip are already off).

Monitor Matrix Screen

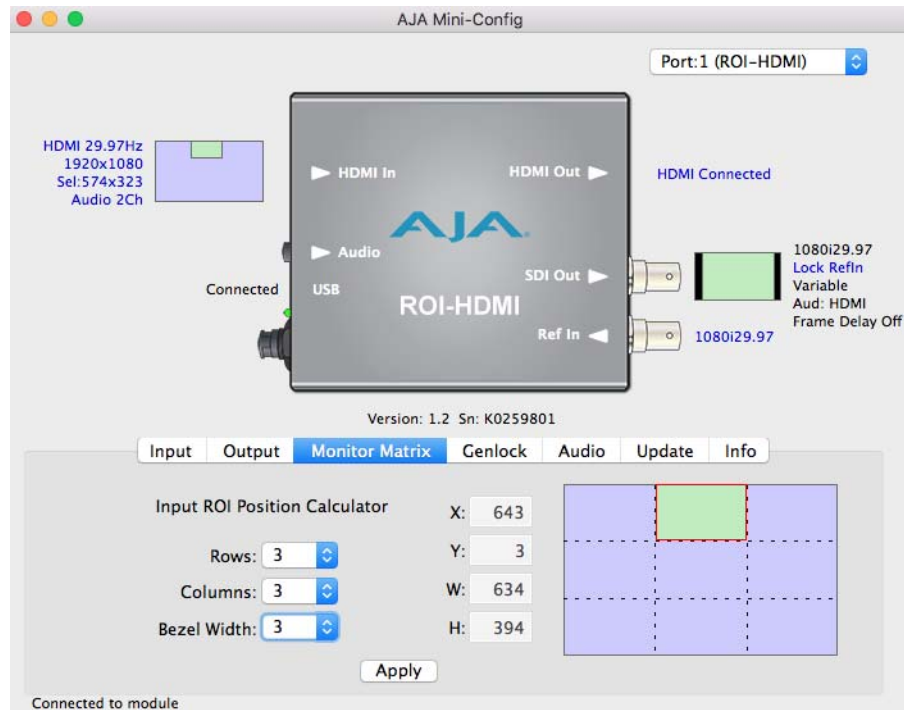

The Monitor Matrix screen offers controls that let you easily define Input Region of Interest dimensions suitable for a multiple monitor matrix display. Typically a monitor matrix is a horizontal and vertical stacking of monitors, with a physical bezel distance separating the edges of the displays from each other. Dedicating one ROI to feed each monitor, and sending the same input video to all the ROIs, makes it possible to display that video so it spans across all the monitors.

Monitor Matrix Representation

A representation of the monitor matrix is shown in the Proxy Screen on the lower right. Clicking selects the area of the monitor at that location in the matrix. When row and column values are entered, a graphical representation of a matrix will be displayed. A default monitor position will be shown as yellow. A new monitor position can be selected by moving the mouse cursor over the desired position and selecting it. The Input Region of Interest position (X,Y) and size (W,H) values will then be automatically calculated. When Apply is clicked, the monitor position rectangle will turn green. When a non-zero Bezel Width is entered, the bezel border around that area is colored red.

Rows Select the number of rows in the monitor matrix. Select from 1 to 20.

Columns Select the number of columns in the monitor matrix. Select from 1 to 20.

Bezel Width Select the bezel width of the display. This width will be used in calculating the Input Region of Interest.

Note that adjoining displays could have a different bezel width and require a different value entered on the ROI driving that monitor.

X, Y, W, H The currently calculated Input Region of Interest position (X,Y) and size (W,H) are displayed here. These values are grayed out and cannot be adjusted. Once the values are applied, they can be adjusted on the Input tab.

Apply Click on the Apply button to transfer the current Input Region of Interest dimensions to the Input screen.

Genlock Screen

The Genlock screens vary depending on the ROI model. The ROI-DVI and ROI-HDMI models do not support EDID Flow Through control, and the ROI-DP model has fewer Genlock options.

ROI-HDMI and ROI-DVI Genlock Screen

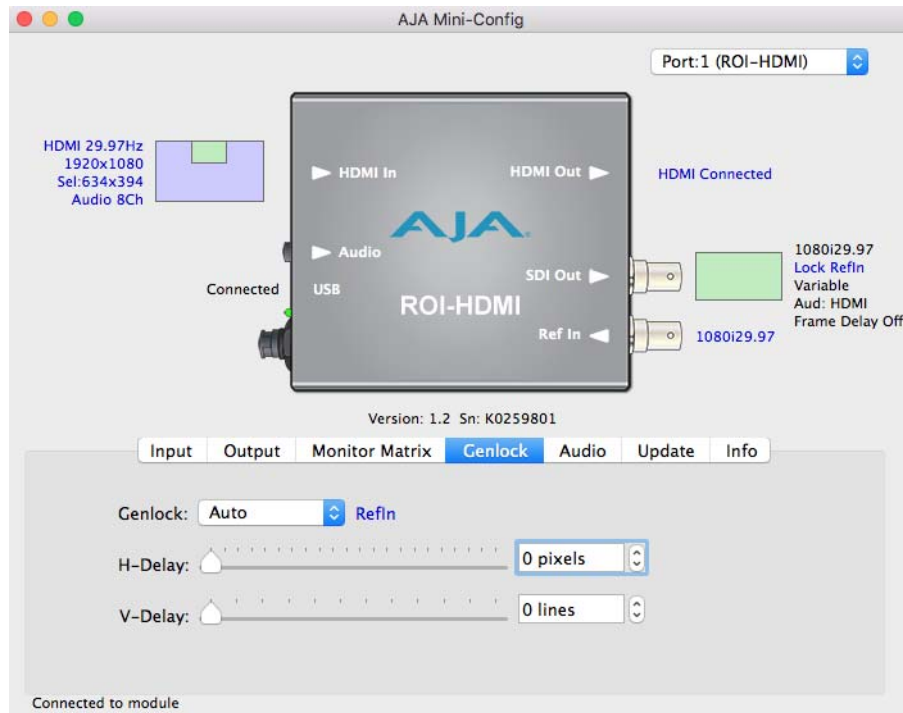

- Genlock** The Genlock control offers the following options:
- Auto – use Ref Input if present, then Input signal if valid, then free-run
 - Free-run – Lock to internal clock
 - Ref In – Lock to the Video Reference input
 - HDMI – Lock to the HDMI/DVI Input (if valid video rate)

NOTE: When HDMI is selected, ROI can lock to input formats that have a SMPTE raster and frame rate and are within 50 ppm of the SDI output format.

NOTE: The actual resultant Genlock status is reported to the right of the selection menu.

- H- and V-Delay** These controls let you adjust H and V delay from the sync input, by dragging the slider or entering values in the windows on the right. Horizontal delay is entered in pixels, while Vertical delay is entered in lines.

NOTE: H and V delay adjustments are only available when the SDI Out Format is compatible with the current sync input reference.

ROI-DP Genlock Screen

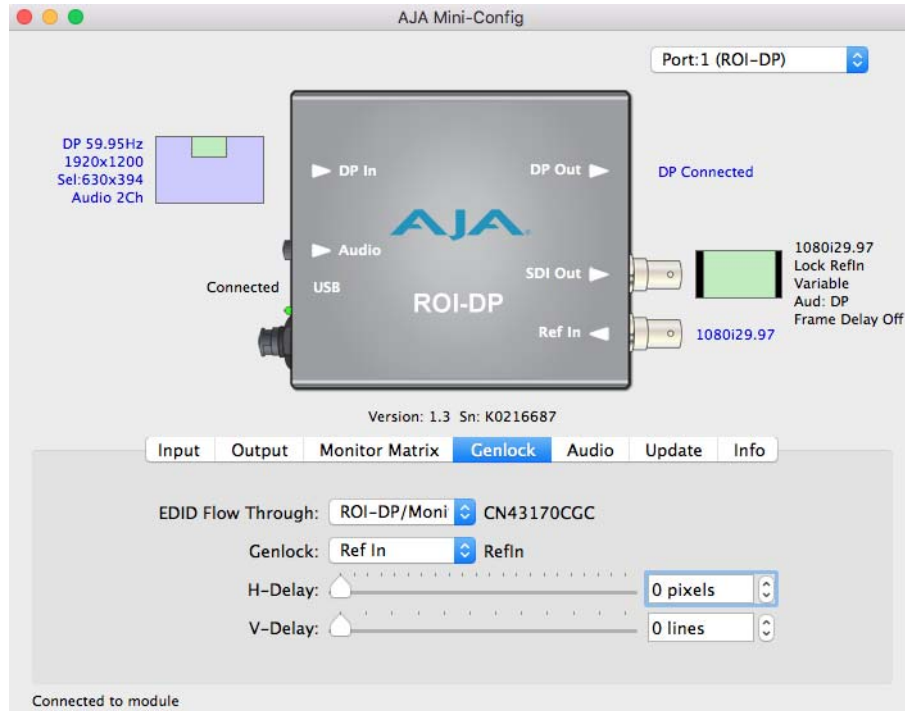

EDID Flow Through The EDID Flow Through setting selects what EDID (Extended Display Identification Data) is provided to the upstream source (i.e. a connected computer). EDID is used by the source to determine what resolution and format to output on the monitor connector. You can select the EDID originating from the ROI itself, or the EDID from a downstream device connected to the ROI output monitor connector.

- ROI-DP – The upstream source sees only the EDID of the ROI.
- ROI/Monitor – The upstream source sees the downstream device’s EDID if a device is connected to the output monitor connector (HDMI, DP, DVI), otherwise the source sees the EDID of the ROI.

This control is useful if, for example, a 4K monitor is connected to the ROI monitor output connector, in which case the pixel clock rate might be higher than the ROI can process, resulting in a red matte on the SDI output. Choosing the “ROI-DP” EDID Flow Through setting can solve that problem. This setting replaces the downstream device’s EDID with the ROI EDID. The source should then renegotiate a display format that is within the operating range of the ROI.

Genlock The Genlock control offers the following options:

- Free-run – Lock to internal clock
- Ref In – Lock to the Video Reference input

NOTE: The actual resultant Genlock status is reported to the right of the selection menu.

H- and V-Delay These controls let you adjust H and V delay from the sync input, by dragging the slider or entering values in the windows on the right. Horizontal delay is entered in pixels, while Vertical delay is entered in lines.

NOTE: H and V delay adjustments are only available when the SDI Out Format is compatible with the current sync input reference.

Audio Screen

The Audio screens vary depending on the ROI model.

ROI-HDMI and ROI-DVI Audio Screen

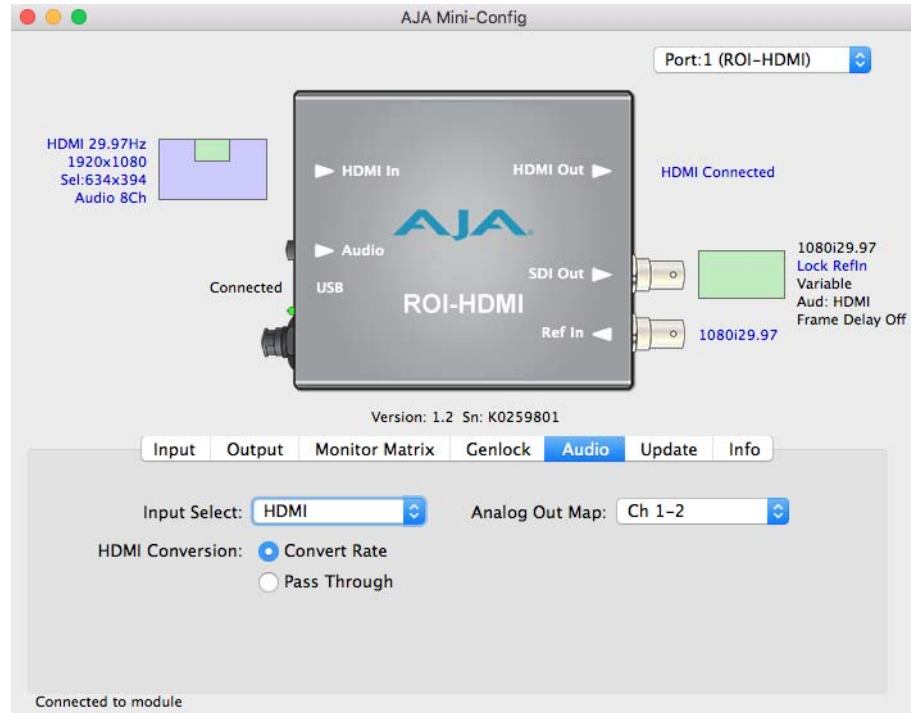

In default mode, the ROI passes up to eight channels of embedded audio from the HDMI or DVI input to the SDI output, and mutes embedded audio to the HDMI or DVI output.

NOTE: *The ROI-DVI model can receive both DVI and HDMI protocol input, and accepts audio if it is embedded in an HDMI signal. However, the DVI protocol does not carry audio, so if the ROI-DVI is receiving DVI input, only analog audio can be embedded to the output.*

- Input Select** Use this control to select which input audio to pass to the SDI output.
- **HDMI** - This selection passes the HDMI incoming audio to the SDI output (up to 8 channels).
 - **Analog** - This selection passes only the Analog audio input for inclusion into the SDI audio stream. In this case, you can use the *Analog Out Map* pulldown menu to select the specific channel pair you want to carry the signal.
 - **Analog + HDMI** - This selection causes the Analog audio input to replace one pair of the HDMI audio channels on the SDI output. The analog audio is inserted on the channels defined by the *Analog Out Map* pulldown.
 - **None** - No audio is output (mute) on the SDI output.

HDMI Conversion The *Convert Rate* button enables ROI Series to convert incoming HDMI audio between 32 kHz to 96 kHz to 48 kHz (the SDI native audio standard). If you don't want to convert, choose *Pass Through*.

Analog Out Map This control selects which two SDI embedded audio channels receive the incoming L R analog audio when Embed into SDI is set to *Analog* or *Analog + HDMI*. Choose from *Ch 1-2*, *Ch 3-4*, *Ch 5-6*, or *Ch 7-8*.

ROI-DP Audio Screen

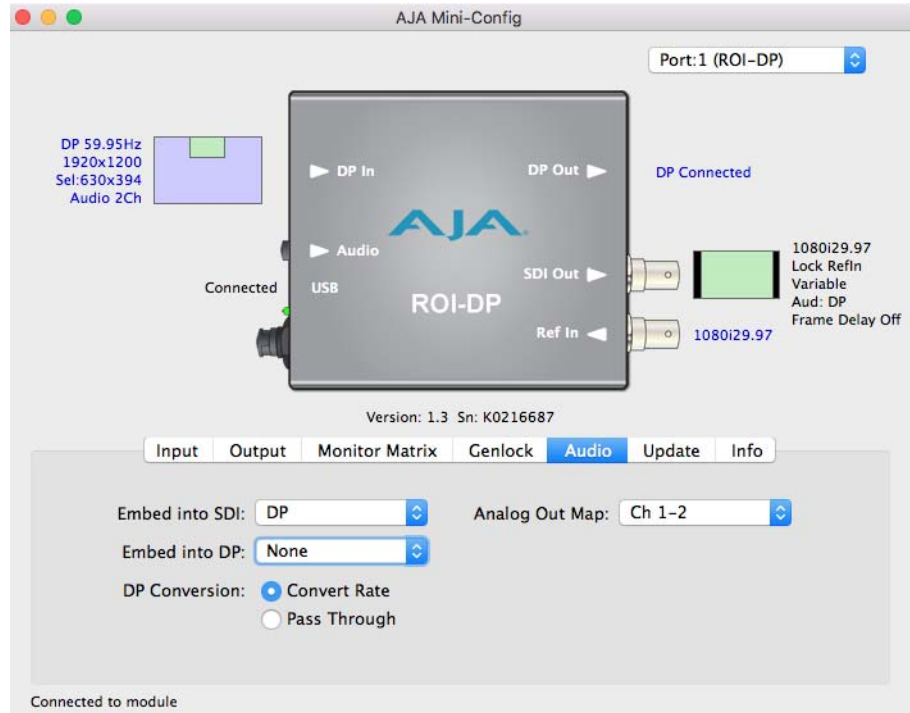

In default mode, the ROI passes up to eight channels of embedded audio from the DisplayPort input to the SDI output, and mutes embedded audio to the DisplayPort output.

- Embed into SDI** Use this control to select which input audio is passed to the SDI output.
- DP - This selection passes the DisplayPort incoming audio to the SDI output (up to 8 channels).
 - Analog - This selection passes only the Analog audio input for inclusion into the SDI audio stream. In this case, you can use the *Analog Out Map* pulldown menu to select the specific channel pair you want to carry the signal.
 - Analog + DP - This selection causes the Analog audio input to replace one pair of the DisplayPort audio channels on the SDI output. The analog audio is inserted on the channels defined by the Analog Out Map pulldown.
 - None - No audio is output (mute) on the SDI output.

- Embed into DP** Use this control to select which input audio is passed to the DisplayPort output.
- None - No audio is output (mute) on the DisplayPort output.
 - DP - The DisplayPort incoming audio passes to the DisplayPort output (up to 8 channels).

DP Conversion The *Convert Rate* button enables ROI Series to convert incoming DisplayPort audio between 32 kHz to 96 kHz to 48 kHz (the SDI native audio standard). If you don't want to convert, choose *Pass Through*.

Analog Out Map This control selects which two SDI embedded audio channels receive the incoming L R analog audio when Embed into SDI is set to *Analog* or *Analog + DP*. Choose from *Ch 1-2*, *Ch 3-4*, *Ch 5-6*, or *Ch 7-8*.

Update Screen

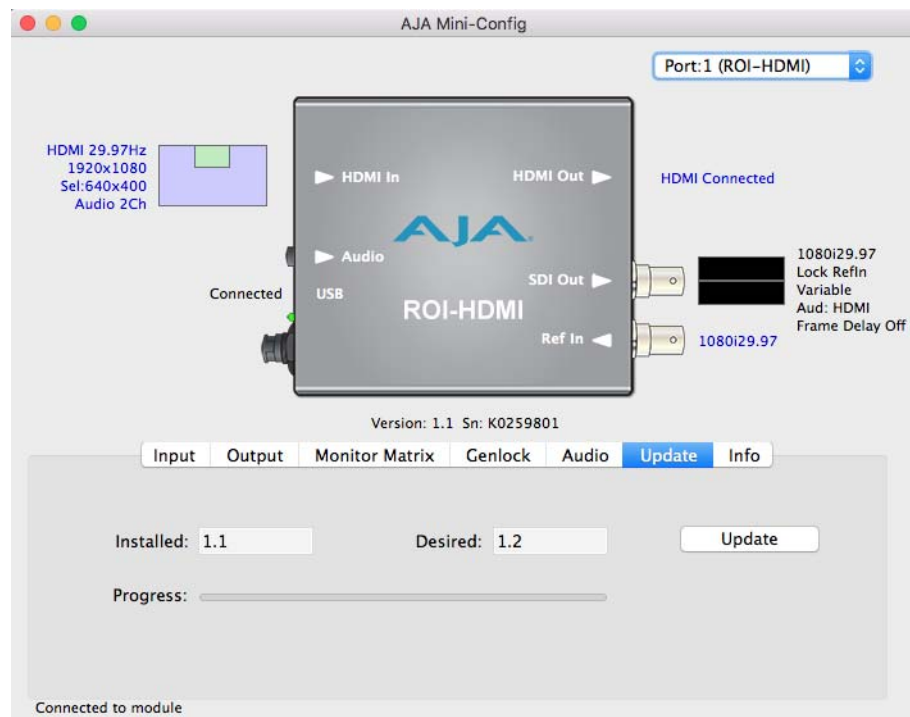

Use this Update screen to view the software version currently installed on the converter or install new software.

NOTE: When discussing Mini-Converters, “Firmware” is software that will be stored in the Mini-Converter’s non-volatile memory and used when it is powered up. This is something different than the Mini-Config application software. The version numbers shown in the Update screen refer only to the firmware.

Installed: This field shows the version of the firmware currently installed inside the Mini-Converter.

Desired: This field shows the version of firmware embedded in the Mini-Config application which you can install into the Mini-Converter by clicking the *Update* button.

Update This button initiates a software update operation loading the “Desired” version of firmware into the Mini-Converter’s non-volatile memory.

Progress: This indicator bar shows the progress of firmware installation.

Software Update Procedure

1. Check the AJA website for new Mini-Config software for your Mini-Converter. If new software is found, download it and uncompress the file archive (zip). Here is the URL to use when checking:
<http://www.aja.com/en/products/mini-converters/mini-config-software>
2. Connect the Mini-Converter to a Mac or PC via a USB port on the computer and run the new Mini-Config software just downloaded.
3. Click on the Update tab screen.
4. Check the Installed version level against the Desired version level. If the Desired is newer, then click the *Update* button to download the new firmware to the Mini-Converter; progress will be shown via the “Progress” thermometer bar.

Info Tab Screen

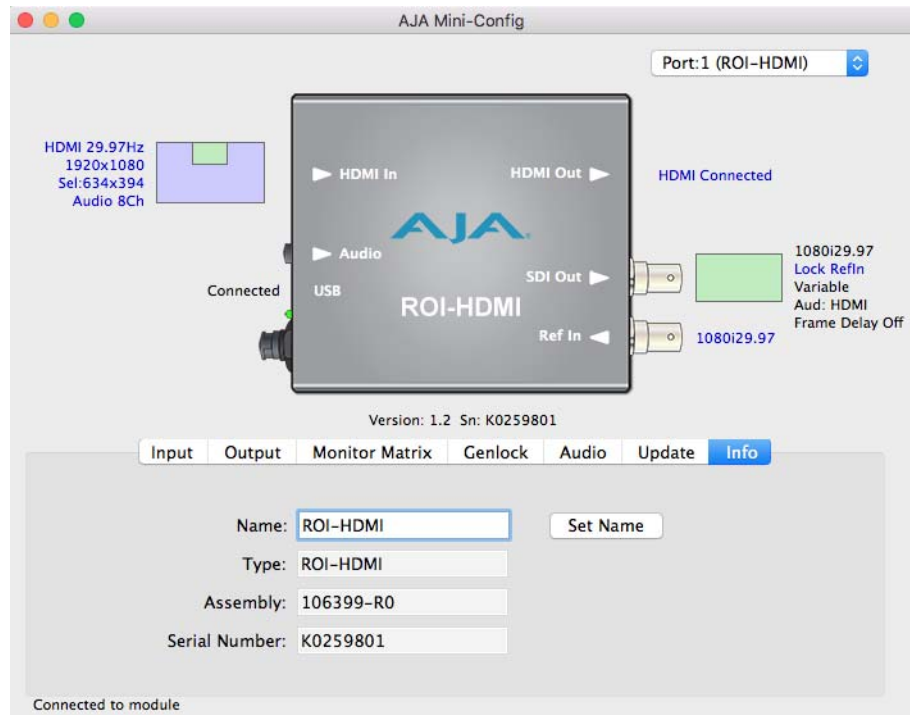

This screen provides basic information about the Mini-Converter. This information is mostly useful when calling AJA Support for service or technical support.

Name This field allows you to give your Mini-Converter a name. This can be useful if you have several Mini-Converters attached to a Mac/PC via USB so you can distinguish between them easily (especially if they're the same model).

Type: This is the factory set model name of the Mini-Converter.

Assembly: This is the factory assembly number.

Serial Number: This is the factory set unique serial number of your Mini-Converter. If you ever call AJA Support for service, you may be asked for this number.

Appendix A: Specifications

Video Input

- ROI-HDMI** • 1 x HDMI 1.3 input connector
- ROI-DP** • 1 x DisplayPort 1.1a input connector
- ROI-DVI** • 1 x DVI-I input connector (digital only)

Input Formats

- Computer Signals:*
- WUXGA (1920x1200) 60 Hz max
 - VGA (640x480) minimum

NOTE: Computer signal input formats are limited to a pixel clock rate of 165MHz.

- Video Signals:*
- 2048x1080p 23.98, 24, 25, 29.97, 30, 50, 59.94, 60
 - 1080p 23.98, 24, 25, 29.97, 30, 50, 59.94, 60
 - 1080i 25, 29.97, 30 (50, 59.94, 60 fields)
 - 720p 23.98, 24, 25, 29.97, 30, 50, 59.94, 60
 - 525i, 625i
 - 480p, 576p (DSLR cameras)

Input Data Range Control

- Full range: 0-255 (8 bit), 0-1023 (10 bit)
- SMPTE range: 16-235 (8 bit), 64-940 (10 bit)

Reference Input

Supported reference video inputs include:

- 525i Blackburst
- 625i Blackburst
- 720p Tri-level Sync
- 1080i Tri-level Sync
- 1080p Tri-level Sync

Genlock

- Reference Input
- HDMI
- Free Run
- Auto

Video Processing

Frame Rate Conversion

Any supported input frame rate can be converted to any selected output frame rate.

Output Video Delay

One frame.

Horizontal • Adjustable by pixel.

Vertical • Adjustable by line.

Video Output

ROI-HDMI • 1 x HDMI output loop through connector

ROI-DP • 1 x DisplayPort output loop through connector

ROI-DVI • 1 x DVI-I output loop through connector

All Models

SDI: • 3G/HD/SD-SDI, SMPTE-259/292/424, 1 x BNC

Output Formats

• 1080p 23.98, 24, 25, 29.97, 30, 50, 59.94, 60

• 1080i 25, 29.97, 30 (50, 59.94, 60 fields)

• 720p 50, 59.94, 60

• 625i 25 (50 fields)

• 525i 29.97 (59.94 fields)

HDCP • ROI converters do not encode the output with HDCP encryption.

• ROI converters do not accept HDCP input.

Audio Input

• 1 x Analog 3.5mm TRS connector, 2-channel

• HDMI and DisplayPort embedded audio, 24-bit, 8-channel

Audio Output

• SDI embedded audio, 24-bit, 2-channel or 8-channel

• HDMI and DisplayPort embedded audio, 24-bit, 8-channel

User Controls

• USB port used with supplied cable and Mini-Config software application to configure device via Mac or Windows

Physical

- Power**
- +5 to 20VDC regulated, 8 watts max
 - AJA external power supply model DWP-U-R1 (included):
 - 100-240V, 50/60Hz universal input

- Size**
- 5.765" x 4.020" x 0.9" (146.431mm x 102.108mm x 22.86mm)

Environment

Operating Temperature: 0 to 40 degrees C (32 to 104 degrees F)

Operating Relative Humidity: 10-90% non-condensing

Operating Altitude: <3,000 meters (<10,000 feet)

Safe Storage Temperature (Power OFF): -40 to 60 degrees C (-40 to 140 degrees F)

Appendix B: Safety & Compliance

Federal Communications Commission (FCC) Compliance Notices

Class A Interference Statement

This equipment has been tested and found to comply with the limits for a Class A digital device, pursuant to Part 15, Subpart B of the FCC Rules. These limits are designed to provide reasonable protection against harmful interference in a residential installation. This equipment generates, uses, and can radiate radio frequency energy and, if not installed and used in accordance with the instructions, may cause harmful interference to radio communications. However, there is no guarantee that interference will not occur in a particular installation. If this equipment does cause harmful interference to radio or television reception, which can be determined by turning the equipment off and on, the user is encouraged to try to correct the interference by one or more of the following measures:

- Reorient or relocate the receiving antenna.
- Increase the separation between the equipment and receiver.
- Connect the equipment into an outlet on a circuit different from that to which the receiver is connected.
- Consult the dealer or an experienced radio/TV technician for help.

FCC Caution

This device complies with Part 15 of the FCC Rules. Operation is subject to the following two conditions: (1) This device may not cause harmful interference, and (2) this device must accept any interference received, including interference that may cause undesired operation.

Canadian ICES Statement

Canadian Department of Communications Radio Interference Regulations

This digital apparatus does not exceed the Class A limits for radio-noise emissions from a digital apparatus as set out in the Radio Interference Regulations of the Canadian Department of Communications. This Class A digital apparatus complies with Canadian ICES-003.

Règlement sur le brouillage radioélectrique du ministère des Communications

Cet appareil numérique respecte les limites de bruits radioélectriques visant les appareils numériques de classe A prescrites dans le Règlement sur le brouillage radioélectrique du ministère des Communications du Canada. Cet appareil numérique de la Classe A est conforme à la norme NMB-003 du Canada.

European Union and European Free Trade Association (EFTA) Regulatory Compliance

This equipment may be operated in the countries that comprise the member countries of the European Union and the European Free Trade Association. These countries, listed in the following paragraph, are referred to as The European Community throughout this document:

AUSTRIA, BELGIUM, BULGARIA, CYPRUS, CZECH REPUBLIC, DENMARK, ESTONIA, FINLAND, FRANCE, GERMANY, GREECE, HUNGARY, IRELAND, ITALY, LATVIA, LITHUANIA, LUXEMBOURG, MALTA, NETHERLANDS, POLAND, PORTUGAL, ROMANIA, SLOVAKIA, SLOVENIA, SPAIN, SWEDEN, UNITED KINGDOM, ICELAND, LICHTENSTEIN, NORWAY, SWITZERLAND

Declaration of Conformity

Marking by this symbol indicates compliance with the Essential Requirements of the EMC Directive of the European Union 2004/108/EC.



This equipment meets the following conformance standards:

Safety: EN 60065: 2002 + A1: 2006 + A11: 2008 + A2: 2010 + A12: 2011 (GS License)

IEC 60065: 2001 + A1: 2005 + A2: 2010 (CB Scheme Report/Certificate)

Additional licenses issued for specific countries available on request.

Emissions: EN 55032: 2012, CISPR 22: 2008, EN 55022: 2010, EN 61000-3-2:2006 +A1:2009 +A2:2009
EN 61000-3-3:2008

Immunity: EN 55103-2: 2009, EN 61000-4-2:2009, EN 61000-4-3:2006 +A1:2008 +A2:2010,
EN 61000-4-4:2004+ A1:2010, EN 61000-4-5:2006, EN 61000-4-6:2009,
EN 61000-4-11:2004

Environments: E2, E3 and E4

The product is also licensed for additional country specific standards as required for the International Marketplace.



Warning!

This is a Class A product. In a domestic environment, this product may cause radio interference, in which case, the user may be required to take appropriate measures.

Achtung! Dieses ist ein Gerät der Funkstörgrenzwertklasse A. In Wohnbereichen können bei Betrieb dieses Gerätes Rundfunkstörungen auftreten, in welchen Fällen der Benutzer für entsprechende Gegenmaßnahmen verantwortlich ist.

Attention! Ceci est un produit de Classe A. Dans un environnement domestique, ce produit risque de créer des interférences radioélectriques, il appartiendra alors à l'utilisateur de prendre les mesures spécifiques appropriées.

Recycling Notice

	<p>This symbol on the product or its packaging indicates that this product must not be disposed of with your other household waste. Instead, it is your responsibility to dispose of your waste equipment by handing it over to a designated collection point for the recycling of waste electrical and electronic equipment. The separate collection and recycling of your waste equipment at the time of disposal will help conserve natural resources and ensure that it is recycled in a manner that protects human health and the environment. For more information about where you can drop off your waste for recycling, please contact your local authority, or where you purchased your product.</p>
---	---

Korean KCC Compliance Statement

<p>A급 기기 (업무용 방송통신기자재)</p> <p>Class A (Broadcasting Communication Equipment for Office Use)</p>	<p>이 기기는 업무용(A급) 전자파적합기기로서 판매자 또는 사용자는 이 점을 주의하시기 바라며, 가정외의 지역에서 사용하는 것을 목적으로 합니다.</p> <p>As an electromagnetic wave equipment for office use (Class A), this equipment is intended to use in other than home area. Sellers or users need to take note of this.</p>
---	---

Taiwan Compliance Statement

警告使用者：
這是甲類的資訊產品，在居住的環境中使用時，可能會造成射頻干擾，在這種情況下，使用者會被要求採取某些適當的對策。

This is a Class A product based on the standard of the Bureau of Standards, Metrology and Inspection (BSMI) CNS 13438, Class A. In a domestic environment this product may cause radio interference in which case the user may be required to take adequate measures.

Japanese Compliance Statement

1. Class A ITE

この装置は、クラスA 情報技術装置です。この装置を家庭環境で使用すると電波妨害を引き起こすことがあります。この場合には使用者が適切な対策を講ずるよう要求されることがあります。VCCI-A

This is a Class A product based on the standard of the VCCI Council (VCCI V-3/2015.04). If this equipment is used in a domestic environment, radio interference may occur, in which case, the user may be required to take corrective actions.

Translated Warning and Caution Messages

The following caution statements, warning conventions, and warning messages apply to this product and manual.



Warning Symbol



Caution Symbol

Before Operation Please Read These Instructions



Warning!

Read and follow all warning notices and instructions marked on the product or included in the documentation.

Avertissement ! Lisez et conformez-vous à tous les avis et instructions d'avertissement indiqués sur le produit ou dans la documentation.

Warnung! Lesen und befolgen Sie die Warnhinweise und Anweisungen, die auf dem Produkt angebracht oder in der Dokumentation enthalten sind.

¡Advertencia! Lea y siga todas las instrucciones y advertencias marcadas en el producto o incluidas en la documentación.

Aviso! Leia e siga todos os avisos e instruções assinalados no produto ou incluídos na documentação.

Avviso! Leggere e seguire tutti gli avvisi e le istruzioni presenti sul prodotto o inclusi nella documentazione.



Warning!

Do not use this device near water and clean only with a dry cloth.

Avertissement! N'utilisez pas cet appareil près de l'eau et nettoyez-le seulement avec un tissu sec..

Warnung! Das Gerät nicht in der Nähe von Wasser verwenden und nur mit einem trockenen Tuch säubern.

¡Advertencia! No utilice este dispositivo cerca del agua y límpielo solamente con un paño seco.

Aviso! Não utilize este dispositivo perto da água e limpe-o somente com um pano seco.

Avviso! Non utilizzare questo dispositivo vicino all'acqua e pulirlo soltanto con un panno asciutto.

**Warning!**

Do not block any ventilation openings. Install in accordance with the manufacturer's instructions.

Avertissement ! Ne bloquez aucune ouverture de ventilation. Suivez les instructions du fabricant lors de l'installation.

Warnung! Die Lüftungsöffnungen dürfen nicht blockiert werden. Nur gemäß den Anweisungen des Herstellers installieren.

¡Advertencia! No bloquee ninguna de las aberturas de la ventilación. Instale de acuerdo con las instrucciones del fabricante.

Aviso! Não obstrua nenhuma das aberturas de ventilação. Instale de acordo com as instruções do fabricante.

Avviso! Non ostruire le aperture di ventilazione. Installare in conformità con le istruzioni del fornitore.

**Warning!**

Do not install near any heat sources such as radiators, heat registers, stoves, or other apparatus (including amplifiers) that produce heat.

Avertissement ! N'installez pas l'appareil près d'une source de chaleur telle que des radiateurs, des bouches d'air de chauffage, des fourneaux ou d'autres appareils (amplificateurs compris) qui produisent de la chaleur.

Warnung! Nicht in der Nähe von Wärmequellen wie Heizkörpern, Heizregistern, Öfen oder anderen Wärme erzeugenden Geräten (einschließlich Verstärkern) aufstellen.

¡Advertencia! No instale cerca de fuentes de calor tales como radiadores, registros de calor, estufas u otros aparatos (incluidos amplificadores) que generan calor.

Aviso! Não instale perto de nenhuma fonte de calor tal como radiadores, saídas de calor, fogões ou outros aparelhos (incluindo amplificadores) que produzam calor.

Avviso! Non installare vicino a fonti di calore come termosifoni, diffusori di aria calda, stufe o altri apparecchi (amplificatori compresi) che emettono calore.

**Warning!**

Do not defeat the safety purpose of the polarized or grounding-type plug. A polarized plug has two blades with one wider than the other. A grounding type plug has two blades and a third grounding prong. The wide blade or the third prong are provided for your safety. If the provided plug does not fit into your outlet, consult an electrician for replacement of the obsolete outlet.

Avertissement! La sécurité de la prise polarisée ou de la prise de type mise à la terre ne doit en aucun cas être empêchée de fonctionner. Une prise polarisée a deux broches, l'une étant plus large que l'autre. Une prise de type mise à la terre a deux broches et une troisième broche pour la mise à la terre. La broche large ou la troisième broche sont fournies pour votre sécurité. Si la prise fournie ne s'insère pas dans votre prise femelle, consultez un électricien pour le remplacement de la prise femelle obsolète.

Warnung! Der Sicherheitszweck des gepolten bzw. Schukosteckers ist zu berücksichtigen. Ein gepolter Stecker verfügt über zwei Pole, von denen einer breiter als der andere ist. Ein Schukostecker verfügt neben den zwei Polen noch über einen dritten Pol zur Erdung. Der breite Pol bzw. der Erdungspol dienen der Sicherheit. Wenn der zur Verfügung gestellte Stecker nicht in Ihren Anschluss passt, konsultieren Sie einen Elektriker, um den veralteten Anschluss zu ersetzen.

¡Advertencia! No eche por tierra la finalidad del tipo de enchufe polarizado con conexión a tierra. Un enchufe polarizado tiene dos espigas, una más ancha que la otra. Un enchufe con conexión a tierra tiene dos espigas iguales y una tercera espiga que sirve para la conexión a tierra. La espiga ancha, o la tercera espiga, sirven para su seguridad. Si el enchufe suministrado no encaja en el tomacorriente, consulte con un electricista para reemplazar el tomacorriente obsoleto.

Aviso! Não anule a finalidade da segurança da ficha polarizada ou do tipo ligação terra. Uma ficha polarizada tem duas lâminas sendo uma mais larga do que a outra. Uma ficha do tipo de ligação à terra tem duas lâminas e um terceiro terminal de ligação à terra. A lâmina larga ou o terceiro terminal são fornecidos para sua segurança. Se a ficha fornecida não couber na sua tomada, consulte um electricista para a substituição da tomada obsoleta.

Avviso! Non compromettere la sicurezza della spina polarizzata o con messa a terra. Una spina polarizzata ha due spinotti, di cui uno più largo. Una spina con messa a terra ha due spinotti e un terzo polo per la messa a terra. Lo spinotto largo o il terzo polo sono forniti per motivi di sicurezza. Se la spina fornita non si inserisce nella presa di corrente, contattare un elettricista per la sostituzione della presa obsoleta.

**Warning!**

Since the Mains plug is used as the disconnection for the device, it must remain readily accessible and operable.

Avertissement! Puisque la prise principale est utilisée pour débrancher l'appareil, elle doit rester aisément accessible et fonctionnelle.

Warnung! Da der Netzstecker als Trennvorrichtung dient, muss er stets zugänglich und funktionsfähig sein.

¡Advertencia! Puesto que el enchufe de la red eléctrica se utiliza como dispositivo de desconexión, debe seguir siendo fácilmente accesible y operable.

Aviso! Dado que a ficha principal é utilizada como a desconexão para o dispositivo, esta deve manter-se prontamente acessível e funcional.

Avviso! Poiché il cavo di alimentazione viene usato come dispositivo di sconnessione, deve rimanere prontamente accessibile e operabile.

**Warning!**

Protect the power cord from being walked on or pinched particularly at plugs, convenience receptacles, and the point where they exit from the device.

Avertissement! Protégez le cordon d'alimentation pour que l'on ne marche pas dessus ou qu'on le pince, en particulier au niveau des prises mâles, des réceptacles de convenance, et à l'endroit où il sort de l'appareil.

Warnung! Vermeiden Sie, dass auf das Netzkabel getreten oder das Kabel geknickt wird, insbesondere an den Steckern, den Steckdosen und am Kabelausgang am Gerät.

¡Advertencia! Proteja el cable de energía para que no se le pise ni apriete, en especial cerca del enchufe, los receptáculos de conveniencia y el punto del que salen del equipo.

Aviso! Proteja o cabo de alimentação de ser pisado ou de ser comprimido particularmente nas fichas, em tomadas de parede de conveniência e no ponto de onde sai do dispositivo.

Avviso! Proteggere il cavo di alimentazione in modo che nessuno ci cammini sopra e che non venga schiacciato soprattutto in corrispondenza delle spine e del punto in cui esce dal dispositivo.

**Warning!**

Unplug this device during lightning storms or when unused for long periods of time.

Avertissement! Débranchez cet appareil pendant les orages avec éclairso s'il est inutilisé pendant de longues périodes.

Warnung! Das Gerät ist bei Gewitterstürmen oder wenn es über lange Zeiträume ungenutzt bleibt vom Netz zu trennen.

¡Advertencia! Desenchufe este dispositivo durante tormentas eléctricas o cuando no se lo utilice por largos periodos del tiempo.

Aviso! Desconecte este dispositivo da tomada durante trovoadas ou quando não é utilizado durante longos períodos de tempo.

Avviso! Utilizzare soltanto i collegamenti e gli accessori specificati e/o venduti dal produttore, quali il treppiedi e l'esoscheletro.

**Warning!**

Do not open the chassis. There are no user-serviceable parts inside. Opening the chassis will void the warranty unless performed by an AJA service center or licensed facility.

Avertissement! Ne pas ouvrir le châssis. Aucun élément à l'intérieur du châssis ne peut être réparé par l'utilisateur. La garantie sera annulée si le châssis est ouvert par toute autre personne qu'un technicien d'un centre de service ou d'un établissement agréé AJA.

Warnung! Öffnen Sie das Gehäuse nicht. Keine der Geräteteile können vom Benutzer gewartet werden. Durch das Öffnen des Gehäuses wird die Garantie hinfällig, es sei denn, solche Wartungsarbeiten werden in einem AJA-Service-Center oder einem lizenzierten Betrieb vorgenommen.

¡Advertencia! No abra el chasis. El interior no contiene piezas reparables por el usuario. El abrir el chasis anulará la garantía a menos que se lo haga en un centro de servicio AJA o en un local autorizado.

Advertência! Não abra o chassi. Não há internamente nenhuma peça que permita manutenção pelo usuário. Abrir o chassi anula a garantia, a menos que a abertura seja realizada por uma central de serviços da AJA ou por um local autorizado.

Avvertenza! Non aprire lo chassis. All'interno non ci sono parti riparabili dall'utente. L'apertura dello chassis invaliderà la garanzia se non viene effettuata da un centro ufficiale o autorizzato AJA.

**Warning!**

Disconnect the external AC power supply line cord(s) from the mains power before moving the unit.

Avertissement ! Retirez le ou les cordons d'alimentation en CA de la source d'alimentation principale lorsque vous déplacez l'appareil.

Warnung! Trennen Sie die Wechselstrom-Versorgungskabel vom Netzstrom, bevor Sie das Gerät verschieben.

¡Advertencia! Cuando mueva la unidad desenchufe de la red eléctrica el/los cable(s) de la fuente de alimentación CA tipo brick.

Advertência! Remova os cabos CA de alimentação brick da rede elétrica ao mover a unidade.

Avvertenza! Scollegare il cavo dell'alimentatore quando si sposta l'unità.

**Warning!**

Refer all servicing to qualified service personnel. Servicing is required when the device has been damaged in any way, such as power-supply cord or plug is damaged, liquid has been spilled or objects have fallen into the device, the device has been exposed to rain or moisture, does not operate normally, or has been dropped.

Avertissement ! Référez-vous au personnel de service qualifié pour tout entretien. L'entretien est exigé quand l'appareil a été endommagé de quelque manière que ce soit, par exemple lorsque le cordon d'alimentation ou la prise sont endommagés, que du liquide a été versé ou des objets sont tombés dans l'appareil, que l'appareil a été exposé à la pluie ou à l'humidité, ne fonctionne pas normalement ou est tombé.

Warnung! Das Gerät sollte nur von qualifizierten Fachkräften gewartet werden. Eine Wartung ist fällig, wenn das Gerät in irgendeiner Weise beschädigt wurde, wie bei beschädigtem Netzkabel oder Netzstecker, falls Flüssigkeiten oder Objekte in das Gerät gelangen, das Gerät Regen oder Feuchtigkeit ausgesetzt wurde, nicht ordnungsgemäß funktioniert oder fallen gelassen wurde.

¡Advertencia! Consulte al personal calificado por cuestiones de reparación. El servicio de reparación se requiere cuando el dispositivo ha recibido cualquier tipo de daño, por ejemplo cable o espigas dañadas, se ha derramado líquido o se han caído objetos dentro del dispositivo, el dispositivo ha sido expuesto a la lluvia o humedad, o no funciona de modo normal, o se ha caído.

Aviso! Remeta todos os serviços de manutenção para o pessoal de assistência qualificado. A prestação de serviços de manutenção é exigida quando o dispositivo foi danificado mediante qualquer forma, como um cabo de alimentação ou ficha que se encontra danificado/a, quando foi derramado líquido ou caíram objectos sobre o dispositivo, quando o dispositivo foi exposto à chuva ou à humidade, quando não funciona normalmente ou quando foi deixado cair.

Avviso! Fare riferimento al personale qualificato per tutti gli interventi di assistenza. L'assistenza è necessaria quando il dispositivo è stato danneggiato in qualche modo, ad esempio se il cavo di alimentazione o la spina sono danneggiati, è stato rovesciato del liquido è stato rovesciato o qualche oggetto è caduto nel dispositivo, il dispositivo è stato esposto a pioggia o umidità, non funziona correttamente o è caduto.

Warranty Information

Limited Warranty

AJA Video Systems, Inc. (AJA Video) warrants that this product will be free from defects in materials and workmanship for a period of five years from the date of purchase. If a product proves to be defective during this warranty period, AJA Video, at its option, will either repair the defective product without charge for parts and labor, or will provide a replacement in exchange for the defective product.

In order to obtain service under this warranty, you the Customer, must notify AJA Video of the defect before the expiration of the warranty period and make suitable arrangements for the performance of service. The Customer shall be responsible for packaging and shipping the defective product to a designated service center nominated by AJA Video, with shipping charges prepaid. AJA Video shall pay for the return of the product to the Customer if the shipment is to a location within the country in which the AJA Video service center is located. Customer shall be responsible for paying all shipping charges, insurance, duties, taxes, and any other charges for products returned to any other locations.

This warranty shall not apply to any defect, failure or damage caused by improper use or improper or inadequate maintenance and care. AJA Video shall not be obligated to furnish service under this warranty a) to repair damage resulting from attempts by personnel other than AJA Video representatives to install, repair or service the product, b) to repair damage resulting from improper use or connection to incompatible equipment, c) to repair any damage or malfunction caused by the use of non-AJA Video parts or supplies, or d) to service a product that has been modified or integrated with other products when the effect of such a modification or integration increases the time or difficulty of servicing the product.

THIS WARRANTY IS GIVEN BY AJA VIDEO IN LIEU OF ANY OTHER WARRANTIES, EXPRESS OR IMPLIED. AJA VIDEO AND ITS VENDORS DISCLAIM ANY IMPLIED WARRANTIES OF MERCHANTABILITY OR FITNESS FOR A PARTICULAR PURPOSE. AJA VIDEO'S RESPONSIBILITY TO REPAIR OR REPLACE DEFECTIVE PRODUCTS IS THE WHOLE AND EXCLUSIVE REMEDY PROVIDED TO THE CUSTOMER FOR ANY INDIRECT, SPECIAL, INCIDENTAL OR CONSEQUENTIAL DAMAGES IRRESPECTIVE OF WHETHER AJA VIDEO OR THE VENDOR HAS ADVANCE NOTICE OF THE POSSIBILITY OF SUCH DAMAGES.

Index

A

- Analog Out Map 27, 28
- Apply button 24
- Audio Screen 27
 - ROI-DP 28
 - ROI-DVI 27
 - ROI-HDMI 27

B

- Bezel Width 24
- Block Diagram 6

C

- Camera Video to Switcher 10
- Center Button 18, 21, 24
- Columns 24

D

- Documentation
 - Downloading 12
 - Mini-Converter 12
- DP Conversion
 - ROI-DP 28
- DVI video input 7
- DVI-to-HDMI adapter 7

E

- Edge Filtering Button 21
- EDID Flow Through 26
- Embed Into DP
 - ROI-DP 28
- Embed Into SDI
 - ROI-DP 28
- Exceeds Max Rate 5, 20
 - Solution 5, 26

F

- Features 5
- Flicker Filtering Button 21
- Flip
 - Illustration 22
 - Interaction with Rotation and Frame Delay 22
- Frame Delay 21
 - Interaction with Rotation and Flip 22
- Full Screen Button 18

G

- Genlock Control
 - ROI-DP 26

- ROI-DVI 25
- ROI-HDMI 25
- Genlock Screen 25
 - ROI-DP 26
 - ROI-DVI 25
 - ROI-HDMI 25

H

- H- and V-Delay 25, 26
- HDCP Protection 4
- HDMI Conversion
 - ROI-DVI 27
 - ROI-HDMI 27
- HDMI video input 8
- HDMI-to-DVI adapter 8
- Horizontal Flip 21

I

- I/O Connections 6
- Info Screen 30
- Input Screen 17
- Input Select
 - ROI-DVI 27
 - ROI-HDMI 27
- Installation Overview 11

M

- Matte Background 21
- Mini-Config
 - Installation on Mac 13
 - Installation on PC 12
 - Operation 15
 - Running Multiple Converters 15
 - Screen Description 16
 - Startup 14
- Mini-Config Overview 6
- Mini-Config Screen
 - Audio 27
 - Genlock 25
 - Info 30
 - Input 17
 - Monitor Matrix 24
 - Output 20
 - Update 29
- Mini-Converter Documentation 12
- Monitor Matrix Representation 24
- Monitor Matrix Screen 24

O

- Output Screen 20

Overview 4

P

Pixel Clock Rate 5

Processing Limit Exceeded
resolving 23

Processing Limit Exceeded message 23

R

Red Matte 5, 20, 26
Solution 5, 26

Red SDI Output 5, 20

RGB Range Menu 18

ROI Configurations 8

ROI Features 5

ROI Models

ROI-DP 5, 7

ROI-DVI 5, 8

ROI-HDMI 5, 6

ROI Out Scaling

Output Scaling 20

ROI Overview 4

ROI Selection 17

Click and Drag Options 18

ROI-DP 5

Audio Screen 28

Connectors 7

DP Conversion 28

Embed Into DP 28

Embed Into SDI 28

Genlock Control 26

Genlock Screen 26

ROI-DVI 5

Audio Screen 27

Connectors 8

Genlock Control 25

HDMI Conversion 27

Input Select 27

ROI-DVI Genlock Screen 25

ROI-HDMI 5

Audio Screen 27

Connectors 6

Genlock Control 25

Genlock Screen 25

HDMI Conversion 27

Input Select 27

Rotation 21

Illustration 22

Interaction with Flip and Frame Delay 22

Rotation with Portrait Monitors 10

Rows 24

S

Screen Picker

Use 18

Screen Picker Button 20

SDI Output Format 21

Simplified Block Diagram 6

Software Update Procedure 29

Specifications 31

System Interconnect Diagrams 8

U

Update Screen 29

V

Vertical Flip 22

X

X, Y, W, H 24