



INSTRUCTION MANUAL

AP-60-860A

Model	Stock No.	Description
AP-60-860A	59819	Agile Processor

Status	Date	Document No.	Issue No.	Author
Active	Sept. 1, 2010	651225000A	1	KK



We recommend that you write the following information in the spaces provided below.

Purchase Location Name:	
Purchase Location Telephone Number:	
AP-60-860A Serial Number:	

The information contained herein is subject to change without notice. Revisions may be issued to advise of such changes and/or additions.

Correspondence regarding this publication should be addressed directly to:

Blonder Tongue Laboratories, Inc.

One Jake Brown Road

Old Bridge, NJ 08857

Document Number: USA 651225000A

Printed in the United States of America.

All product names, trade names, or corporate names mentioned in this document are acknowledged to be the proprietary property of the registered owners.

This product incorporates copyright protection technology that is protected by U.S. patents and other intellectual property rights. Reverse engineering or disassembly is prohibited.

Table of Contents

SECTION 1 – GENERAL & SAFETY INSTRUCTIONS	4
SECTION 2 – PRODUCT SUMMARY	6
2.1 REVISION HISTORY & REASON	6
2.2 PRODUCT SERIES APPLICATION & DESCRIPTION	6
2.3 PRODUCT SPECIFICATION	8
SECTION 3 – INSTALLATION & POWER-UP	9
3.1 UNPACKING	9
3.2 INSTALLATION	9
3.3 POWER-UP	9
SECTION 4 – QUICK CONFIGURATION	10
4.1 GENERAL	10
4.2 QUICK CONFIGURATION	12
4.3 FRONT-PANEL STATUS MESSAGES	12
4.4 FRONT-PANEL CONTROL ADJUSTMENT	13
4.5 REAR-PANEL EAS / ALT IF	13
4.6 SUB-BAND INPUT	14
SECTION 5 – ADVANCED CONFIGURATION	15
5.1 “INPUT DEMOD MODE” PARAMETER	15
5.2 “INPUT CH PLAN” PARAMETER	15
5.3 “SCAN MENU”	16
5.4 “INPUT CHANNEL” PARAMETER	17
5.5 “CHANNEL INFO” PARAMETER	17
5.6 “PICTURE SHAPE” PARAMETER	17
5.7 “OUTPUT AUDIO” PARAMETER	18
5.8 “AUDIO LANGUAGE” PARAMETER	18
5.9 “CC: EIA-608” PARAMETER	19
5.10 “INPUT POWER RESET” PARAMETER	19
5.11 “DIGITAL INPUT” PARAMETER	20
5.12 “AP ADDRESS” PARAMETER	20
5.13 “CONTROL MODULE” PARAMETER	20
5.14 “3.3 VDC INPUT” PARAMETER	20
5.15 “6 VDC INPUT” PARAMETER	20
5.16 “12 VDC INPUT” PARAMETER	20
5.17 “21 VDC INPUT” PARAMETER	20
5.18 “ANALOG MODULE” PARAMETER	20
5.19 “OUTPUT CHANNEL MODE” PARAMETER	20
5.20 “OUTPUT LEVEL” PARAMETER	21
5.21 “RF OUTPUT” PARAMETER	22
5.22 “AP MODE”	22
APPENDIX A: SCREEN ASPECT RATIO	23
APPENDIX B: GLOSSARY OF USEFUL TERMS & ACRONYMS	24

Section 1 — General & Safety Instructions



The STOP sign symbol is intended to alert you to the presence of REQUIRED operating and maintenance (servicing) instructions that if not followed, may result in product failure or destruction.



The YIELD sign symbol is intended to alert you to the presence of RECOMMENDED operating and maintenance (servicing) instructions.



The LIGHTNING flash symbol is intended to alert you to the presence of uninsulated "dangerous voltage" within the product's enclosure that may be sufficient magnitude to constitute a risk of electrical shock.

**TO REDUCE THE RISK OF ELECTRICAL SHOCK, DO NOT REMOVE COVER FROM THIS UNIT.
NO USER-SERVICEABLE PARTS INSIDE. REFER SERVICING TO QUALIFIED SERVICE PERSONNEL.**

WARNING: TO PREVENT FIRE OR SHOCK HAZARD, DO NOT EXPOSE THIS UNIT TO RAIN OR MOISTURE

NOTE TO CATV SYSTEM INSTALLER

This reminder is provided to call the CATV System Installer's attention to Article 820-40 of the NEC that provides guidelines for proper grounding and, in particular, specifies that the cable ground shall be connected to the grounding system of the building, as close to the point of cable entry as practical.

Safety Instructions



**YOU SHOULD ALWAYS FOLLOW THESE INSTRUCTIONS TO HELP ENSURE
AGAINST INJURY TO YOURSELF AND DAMAGE TO YOUR EQUIPMENT.**

- Read all safety and operating instructions before you operate the unit.
- Retain all safety and operating instructions for future reference.
- Heed all warnings on the unit and in the safety and operating instructions.
- Follow all installation, operating, and use instructions.
- Unplug the unit from the AC power outlet before cleaning. Use only a damp cloth for cleaning the exterior of the unit.
- Do not use accessories or attachments not recommended by Blonder Tongue, as they may cause hazards, and will void the warranty.
- Do not operate the unit in high-humidity areas, or expose it to water or moisture.
- Do not place the unit on an unstable cart, stand, tripod, bracket, or table. The unit may fall, causing serious personal injury and damage to the unit. Install the unit only in a mounting rack designed for 19" rack-mounted equipment.

Safety Instructions - continued

- Do not block or cover slots and openings in the unit. These are provided for ventilation and protection from overheating. Never place the unit near or over a radiator or heat register. Do not place the unit in an enclosure such as a cabinet without proper ventilation. Do not mount equipment in the rack space directly above or below the unit.
- Operate the unit using only the type of power source indicated on the marking label. Unplug the unit power cord by gripping the plug, not the cord.
- The unit is equipped with a three-wire ground-type plug. This plug will fit only into a ground-type power outlet. If you are unable to insert the plug into the outlet, contact an electrician to replace the outlet. Do not defeat the safety purpose of the ground-type plug.
- Route power supply cords so that they are not likely to be walked on or pinched by items placed upon or against them. Pay particular attention to cords at plugs, convenience receptacles, and the point where they exit from the unit.
- Be sure that the outdoor components of the antenna system are grounded in accordance with local, federal, and National Electrical Code (NEC) requirements. Pay special attention to NEC Sections 810 and 820. See the example shown in the following diagram:

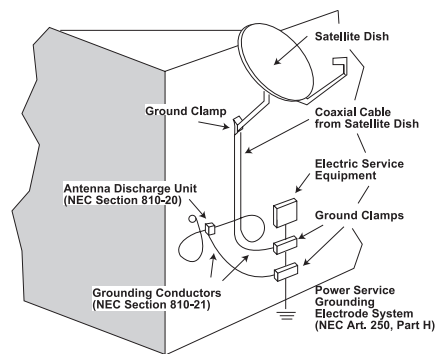

- We strongly recommend using an outlet that contains surge suppression or ground fault protection. For added protection during a lightning storm, or when the unit is left unattended and unused for long periods of time, unplug it from the wall outlet and disconnect the lines between the unit and the antenna. This will prevent damage caused by lightning or power line surges.
- Do not locate the antenna near overhead power lines or other electric light or power circuits, or where it can fall into such power lines or circuits. When installing the antenna, take extreme care to avoid touching such power lines or circuits, as contact with them can be fatal.
- Do not overload wall outlets or extension cords, as this can result in a risk of fire or electrical shock.
- Never insert objects of any kind into the unit through openings, as the objects may touch dangerous voltage points or short out parts. This could cause fire or electrical shock.
- Do not attempt to service the unit yourself, as opening or removing covers may expose you to dangerous voltage and will void the warranty. Refer all servicing to authorized service personnel.
- Unplug the unit from the wall outlet and refer servicing to authorized service personnel whenever the following occurs:
 - The power supply cord or plug is damaged;
 - Liquid has been spilled, or objects have fallen into the unit;
 - The unit has been exposed to rain or water;
 - The unit has been dropped or the chassis has been damaged;
 - The unit exhibits a distinct change in performance.
- When replacement parts are required, ensure that the service technician uses replacement parts specified by Blonder Tongue. Unauthorized substitutions may damage the unit or cause electrical shock or fire, and will void the warranty.
- Upon completion of any service or repair to the unit, ask the service technician to perform safety checks to ensure that the unit is in proper operating condition.

Returning Product for Repair (or Credit)

A Return Material Authorization (RMA) Number is required on all products returned to Blonder Tongue, regardless if the product is being returned for repair or credit. Before returning product, please contact the Blonder Tongue Service Department at 1-800-523-6049, Ext. 4256 or visit our website: www.blondertongue.com for further information.

Section 2 — Product Summary

2.1 Revision History & Reason

This is the first issue of the Instruction Manual.

2.2 Product Series, Application & Description

The AP-60-860A is a versatile agile analog / digital channel processor that can be operated in one of the following three (3) modes;

Digital to Analog Mode – receives one 8VSB or QAM (64/256) input and outputs one NTSC analog RF output channel in the 54-860 MHz range.

Digital to Digital Mode – receives one QAM (64/256) input and outputs one QAM RF output channel in the 54-860 MHz range. The AP is not designed to process 8VSB to 8VSB signals.

Analog to Analog Mode – receiver one NTSC analog channel and outputs one NTSC analog channel between 54 and 860 MHz.

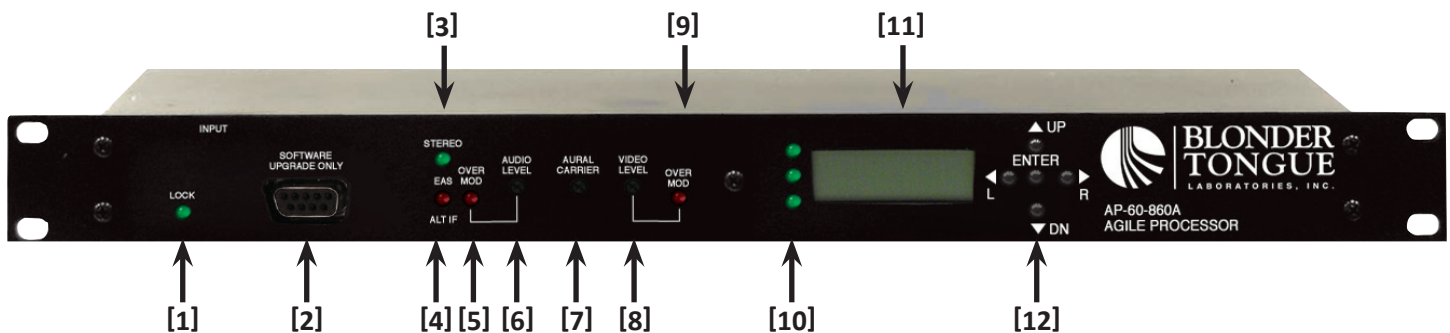

***[1] RF INPUT STATUS INDICATOR:**

Solid Green LED indicates valid lock to the RF input signal. Flashing Green LED indicates Not Locked or Scanning in process

[2] 9-PIN RS-232 CONNECTOR:

Used for future software upgrade

***[3] STEREO LED:**

Solid Green indicates Stereo

[4] EAS/ALT INDICATOR:

Solid Red indicates EAS/ALT IF is activated

***[5] AUDIO OVER MODULATION LED:**

RED LED lights when peak deviation of aural carrier is over 25 kHz

***[6] AUDIO MODULATION CONTROL:**

Adjusts aural carrier modulation

***[7] AURAL CARRIER CONTROL:**

Controls amplitude of aural RF carrier relative to visual RF carrier

***[8] VIDEO MODULATION CONTROL:**

Adjust percentage of modulation

***[9] VIDEO OVER MODULATION LED:**

Lights when modulation is above 87.5%

[10] LED'S NOT USED

[11] LCD SCREEN:

16-character, 2-line Liquid Crystal Display screen for displaying information on the unit

[12] KEY-PAD:

Push-down Buttons to navigate between menus and to operate the unit

*** Only Functional when AP is in Digital to Analog mode.**

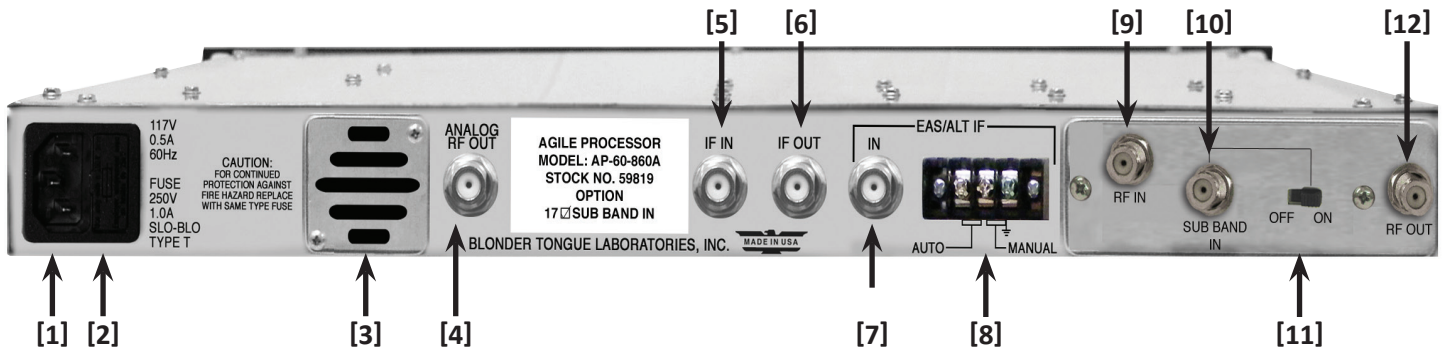

[1] POWER CORD SOCKET:

Power Cord Plug Socket

[2] FUSE HOLDER:

1.0 Amp., 250V DC, Slo Blo Fuse

[3] AIR CIRCULATION FAN

[4] ANALOG RF OUT:

NTSC Analog Output via "F" Connector (QAM output in Digital to Digital mode)

[5] IF IN:

"F" Connector IF Input

[6] IF OUT:

"F" Connector IF Output



MUST LOOP THE IF IN & IF OUT CONNECTORS USING THE 6-INCH COAX CABLE PROVIDED IN PACKAGING.

[7] EAS/ALT IF IN:

"F" Connector for Emergency Alert System (EAS) or Alternate Intermediate Frequency (ALT IF) input

[8] EAS/ALT IF TERMINAL STRIP:

Terminal Connector for Auto/Manual EAS

[9] RF INPUT:

"F" Connector for analog NTSC, 8VSB off-air, or QAM modulated input signal

[10] SUB BAND IN:

Analog or QAM channel T7 to T13, RF input

[11] ON/OFF:

Sub Band up-converter power switch

[12] RF OUT:

Upconverter sub band output (ch7-13)

2.3 Product Specification

INPUT

Connector:	“F” Female
Analog Mode ⁽¹⁾ Standard: Tuning: Bandwidth: Power Level:	NTSC CATV 2-135, Broadcast 2-69, Sub T7-T13 6 MHz -20 to +30 dBmV
QAM Mode ⁽²⁾ Standard: Tuning Range: Data Rate: Bandwidth: Power Level:	ITU-T J.83 - Annex B (64 and 256 QAM) CATV Ch. 2-135 T7-T13 38.8 Mbps (QAM 256); 26.97 Mbps (QAM 64) 6 MHz -20 to +30 dBmV
QAM/8VSB Mode ⁽³⁾ Standard: Tuning Range: Data Rate: Bandwidth: Power Level:	8VSB ATSC Digital Television A/53E QAM ITU-T J.83 - Annex B (64 and 256 QAM) 8VSB VHF (NTSC Ch. 2-13), UHF (NTSC Ch. 14-69) QAM CATV Ch. 2-135 T7-T13 8VSB 19.392 Mbps QAM 38.8 Mbps (QAM 256); 26.97 Mbps (QAM 64) 6 MHz -20 to +30 dBmV

IF (Intermediate Frequency)

Connector:	“F” Female Input / “F” Female Output
Impedance:	75 Ω Input / 75 Ω Output
Return Loss:	16 dB Input / 15 dB Output
EAS/ALT IF Input Level: Switch Isolation:	+38 dBmV @ 45.75 MHz Greater than 60 dB
Standby Carrier	+35 dBmV (RF Input <-25 dBmV)

Modes 1 & 3

Aural Frequency:	41.25 MHz
Visual Frequency:	45.75 MHz
Composite Loop Output Aural Carrier Level: Visual Carrier Level:	+20 dBmV +35 dBmV

Mode 2

Center Frequency:	44 MHz
Output Level:	+30 dBmV

General

Dimensions (W x D x H):	19.0 x 18.625 x 1.75 inches (483 x 473 x 44 mm)
Power:	110 VAC/60 Hz (Fuse: 1 amp, 250 VDC, SloBlo)
Power Dissipation:	36 W
Weight:	7 lbs (3.2 kg)
Operating Temperature:	32 to 122 °F (0 to 50 °C)
Storage Temperature:	-13 to 158 °F (-25 to 70 °C)
Operating Humidity:	0 to 95% RH @ 35 °C max, non-condensation
Storage Humidity:	0 to 95% RH @ 35 °C max, non-condensation

OUTPUT

Analog-to-Analog/Digital-to-Digital Modes

Connector RF Output:	“F” Female
RF Output Frequency Range: Channels: Power Level: Power Level Range: Broadband Noise: Spurious: Impedance: Return Loss: Aural/Visual Carrier Ratio ^{(Mode 1):} Frequency Tolerance Adjacent Channel Rejection:	Analog RF or QAM 54 to 864 MHz UHF, VHF, CATV (Standard, HRC, & IRC) Mode 1 (Analog) +60 dBmV Mode 2 (QAM) +55 dBmV Mode 1 (Analog) +50 to +62 dBmV (in 0.2 dB increments) Mode 2 (QAM) +45 to +57 dBmV (in 0.2 dB increments) Mode 1 (Analog)-77 dBc (@ +60 dBmV output level, 4 MHz bandwidth) Mode 2 (QAM)-75 dBc (@ +55 dBmV output level, 6 MHz bandwidth) -63 dBc 75 Ω 15 dB Input Ratio ±2dB ±20 kHz; 32 to 122 °F (0 to 50 °C) 65 dB

Digital to Analog Mode

Connector RF Output:	“F” Female
RF Output Frequency Range: Channels: Power Level: Power Level Range: Broadband Noise: Spurious: Impedance: Return Loss: Aural/Visual Carrier Ratio:	Analog RF 54 to 864 MHz UHF, VHF, CATV (Standard, HRC, & IRC) +60 dBmV +50 to +62 dBmV (in 0.2 dB increments) -77 dBc (@ +60 dBmV output level, 4 MHz bandwidth) -63 dBc 75 Ω 15 dB -15 dB ±5 Adjustable
Visual Frequency Tolerance Standard Channels: FCC Aeronautical Channels: Video Frequency Response: Video-to-RMS Hum Ratio: Signal-to-Noise Ratio: Differential Gain: Differential Phase: Over-mod. Indicator: Chrom./Luminance Delay:	±20 kHz; 32 to 122 °F (0 to 50 °C) ±5 kHz; 32 to 122 °F (0 to 50 °C) 1.5 dB Peak-to-Valley (fv-0.5 to fv+4.2 MHz) 65 dB 58 dB (Weighted) 2.0% @ 87.5% 1.0 degree 87.5% ±2.5 Per FCC Requirements
Audio Frequency Response: Frequency Range: Signal-to-Noise Ratio: Total Harmonic Distortion: Over-mod. Indicator:	±1.0 dB 50 Hz to 15 kHz 59 dB 1.0% @ 55 kHz Deviation 55 kHz ±2
4.5 MHz Audio Carrier Tolerance:	±150 Hz 32 to 122 °F (0 to 50 °C)

Alarms/Monitoring/Control

Indicators:	Lock (Green LED) Stereo Audio (Green LED) EAS or Alternate IF activated (Red LED) Audio Over-modulation (Red LED) Video Over-Modulation (Red LED)
Local Monitoring: Local Control:	Front-panel, 16-character, 2-line LCD screen Front-panel Navigational Key-pad Audio & Video Modulation Adjustment Aural Carrier Adjustment

Section 3 – Installation & Power-up

3.1 Unpacking

You will find the following items in the box:

AP Processor (QTY=1)

Power Cord with IEC C13 line socket and 3-pin Type B NEMA 5 plug (QTY=1)

(2) 6-inch coax cable for the IF Loop and sub band RF output

3.2 Installation

The unit is designed to be installed in a standard 19-inch (480 mm) rack (EIA 310-D, IEC 60297, and DIN 41494 SC48D).



DO NOT BLOCK THE UNIT'S AIR INTAKE OR AIR DISCHARGE OPENINGS. FOR SAFE AND RELIABLE OPERATION, THE GROUND PIN OF THE POWER CORD PLUG MUST BE GROUNDED PROPERLY.

To install the unit, secure its front panel to the rack by inserting four machine screws, with cup washers, through the four mounting holes in the front panel.

It is recommended to leave 1 rack unit space (1RU = 1.75 inch = 44.45 mm) between each unit to reduce heat build-up in the rack which helps to extend the product's life span.



MUST LOOP THE IF IN & IF OUT CONNECTORS USING THE 6-INCH COAX CABLE PROVIDED IN PACKAGING.

3.3 Power-up



THE POWERING REQUIREMENT IS 110 VAC/60 HZ ONLY.

There is no power on-off switch on this unit. To turn the unit on or off, simply connect/disconnect the power cord to/from the unit. The unit is also equipped with a fuse-holder and fuse (SLO-BLO, 1.0 Amps, 250V).

The following message will be displayed on the LCD screen when the unit is first powered-up:

POWER STATUS
INITIALIZING

AP ADDRESS
00007259

AP
IS READY

"AP ADDRESS" is a unique digital address for the unit and is set at the factory.



THE KEY-PAD REMAINS UNOPERATIONAL DURING THE POWER-UP SEQUENCE. DO NOT ADJUST ANY CONTROLS UNTIL THE SEQUENCE IS COMPLETED AND THE "AP IS READY" MESSAGE IS DISPLAYED.

Upon successful initial power up, the status of the LEDs are as follows:

The "STEREO" LED will be solid Green. After about 30 seconds, the following message will be displayed on the LCD screen:

INPUT NOT LOCKED
NO SIGNAL

Section 4 – Quick Configuration

4.1 General

The Quick Configuration instructions are provided as the minimum steps required to configure the unit. Please see Section 5 for Advanced Configuration.

The front-panel key-pad has for push-down buttons as follows:

- The LEFT button ◀ denoted as **(L)** in this document
- The RIGHT button ▶ denoted as **(R)** in this document
- The UP button ▲ denoted as **(UP)** in this document
- The DOWN button ▼ denoted as **(DN)** in this document
- The ENTER button ● denoted as **(ENTER)** in this document

The **(L)**, **(R)** buttons are primarily used to navigate horizontally within a variable parameter field.

The **(UP)**, **(DN)** buttons are primarily used to toggle between the parameter fields and select new parameter value.

The **(ENTER)** button is used to initiate a parameter value change and to lock the new value after changes are made.

Using the **(UP)**, **(DN)** buttons, you can toggle among the following available “parameter fields” which will be displayed on the LCD screen.

Parameter Fields related to the INPUT are:

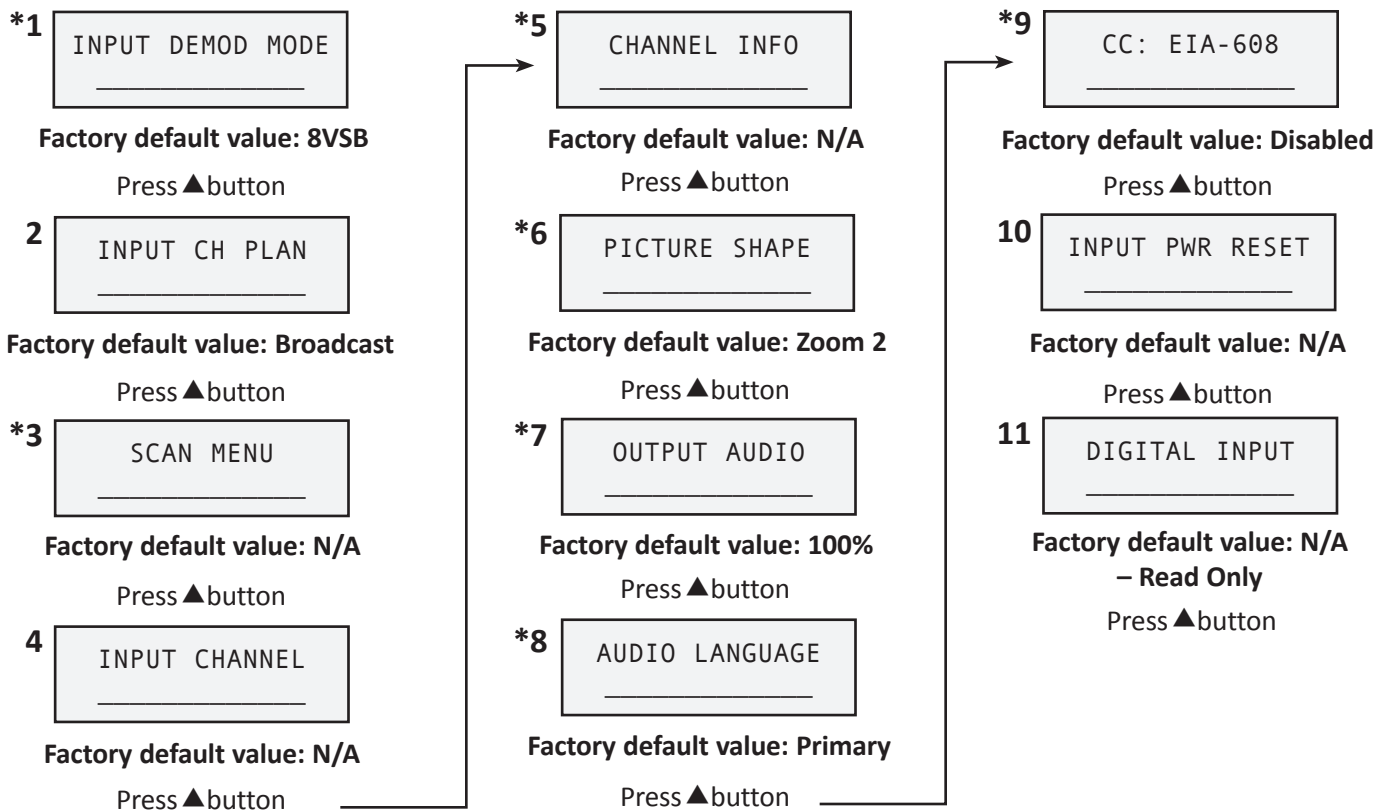

* Applies only to Digital-to-Analog mode. Other modes will display "Not Supported" for these variables.

Parameter Field #4 - Displays as "Input Tune Channel" in the Digital to Analog mode.

Parameter Fields related to the controller circuit-board are:

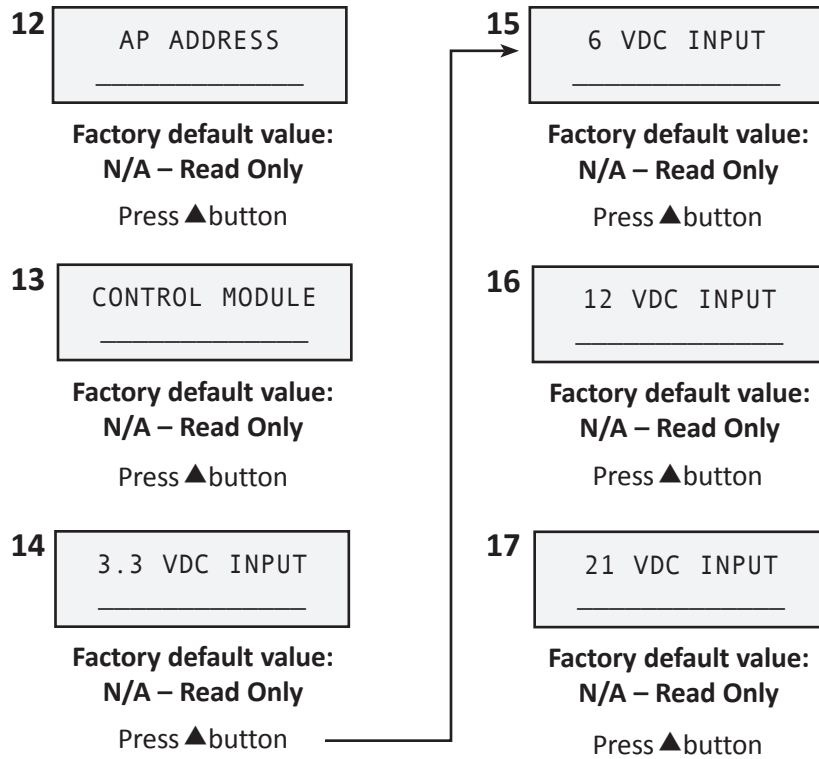

Parameter Fields related to the OUTPUT are:

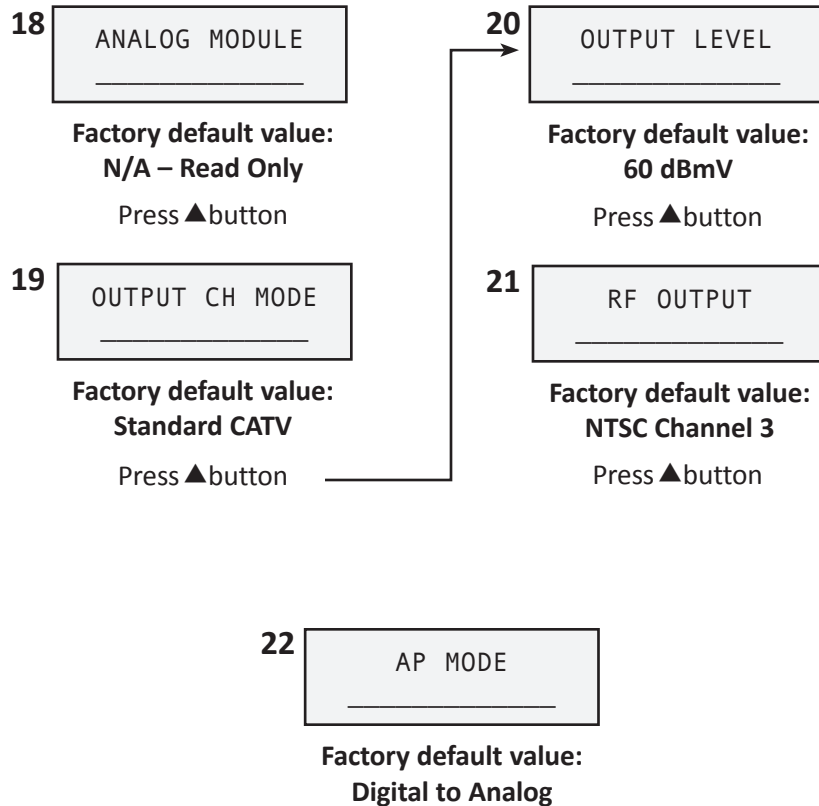

4.2 Quick Configuration

The following steps provide the minimum requirements necessary to configure the unit. Please see Section 5 for Advanced Configuration.

- (1) Measure the RF input level to make sure the input signal is within the -20 to +30 dBmV acquisition range of the unit. The recommended input signal level is -10 to +10 dBmV.
- (2) Connect the input via the "RF IN" "F" connector in the rear of the unit.
- (3) Select the appropriate "AP Mode" (digital>analog, analog>analog, or digital>digital) – see Section 5.22. Use down button once to reach this field from the "Input not locked" message.
- (4) Select the appropriate "INPUT DEMOD MODE" (8VSB or QAM) – see Section 5.1 for procedures (D-A mode only).
- (5) Select the appropriate "INPUT CHANNEL PLAN" (Broadcast, Standard CATV, HRC, or IRC) – see Section 5.2 for procedures.
- (6) Perform a SCAN – see Section 5.3 for procedures (D-A only).

NOTE: Do not change the AP mode after a SCAN has been completed until an input channel is selected and entered (#7). Doing so prior to entering an input channel will result in the loss of the scanned channel database thus requiring the unit to be scanned again if it is to be operated in the digital to analog mode.



A SCAN MUST BE PERFORMED EACH TIME THE "INPUT DEMOD MODE" IS CHANGED.

- (7) Select or enter the desired channel via the "INPUT TUNE CHANNEL" (D>A) / "INPUT CHANNEL" (A>A & D>D) menu - see Section 5.4 for procedures.
- (8) Select the desired "RF OUTPUT" - see Section 5.21 for procedures.
- (9) Select the desired "OUTPUT LEVEL" - see Section 5.20 for procedures.



THE OPTIMUM OUTPUT SIGNAL-TO-NOISE RATIO (SNR) IS ACHIEVED BY SETTING THE OUTPUT LEVEL TO 60 DBMV (ANALOG) OR 55 DBMV (DIGITAL). IF SYSTEM REQUIRES A LOWER LEVEL, THEN ATTENUATE THE LEVEL EXTERNALLY.

4.3 Front-Panel Status Messages

After the unit is configured and while operating in D/A, the following "status" message will be displayed on the LCD screen:

INPUT LOCKED
SNR= □□. □□ dB

- SNR is displayed in Digital-to-Analog mode only when the AP locks to an input program channel. The signal to noise ratio of the input signal and is expressed in dB. The following are the desired input SNR ranges for the appropriate signal modulation type:

	8VSB	64 QAM	256 QAM
Excellent =	>30 dB	>38 dB	>38 dB
Good =	25—30 dB	30—38 dB	35—38 dB
Marginal =	18—25 dB	23—30 dB	30—35 dB
Non-Functional =	<18 dB	<23 dB	<30 dB

You can also retrieve the following current configuration information of the unit by pressing the **(R)** or **(L)** buttons:

AP MODE
 ANALOG->ANALOG

INPUT A->A
 INPUT CH _____

A- > SNR

SNR only in Digital to Analog mode
 D-D and A-A modes not supported

RF OUTPUT
 CH 003 NTSC

This read-only screen indicates the RF output channel – in this case, NTSC channel 3.

OUTPUT LEVEL
 60.2 dBmV

This read-only screen indicates the power level of the RF output channel – in this case, 60.2 dBmV.

Possible Error Messages and their meaning are listed below (D-A mode only):

- NO SIGNAL indicates that the input signal was not detected (no RF input)
- PLEASE SCAN indicates a scan was not performed or is required again
- AUDIO ONLY indicates no video signal
- NO AUDIO indicates no audio signal present
- SCRAMBLED PRG indicates the signal has encryption
- NO PROGRAM will be displayed if a valid lock is acquired but no program signal is actually being detected

4.4 Front-Panel Control Adjustment (D-A mode only)

There are three (3) control pots on the front panel of the unit: Video Level, Audio Level, and Aural Carrier.

VIDEO LEVEL control pot is used to manually adjust the video level. With the intended signal source connected and a representative video program present, turn the Video Level control pot clockwise until the Video Overmodulation LED starts flashing. Then, slightly turn the control pot counter-clockwise so that the Video Overmodulation LED is not flashing anymore. Alternatively, while watching the video on a TV monitor, adjust the control pot to the highest (clockwise) level WITHOUT causing the highlights (white portions of the picture) to become “washed out”.

AUDIO LEVEL control pot is used to manually adjust the audio level. During the highest volume of the audio program, turn the Audio Level control pot clockwise until the Audio Overmodulation LED starts flashing. Then, slightly turn the control pot counter-clockwise so that the Audio Overmodulation LED is not flashing anymore.

AURAL CARRIER control pot is used to manually adjust the aural-to-visual carrier ratio. The recommended ratio is -15 dB.

4.5 Rear-Panel EAS/ALT IF

There is an "F" connector in the rear-panel of the unit for an incoming (input) EAS/ALT signal (Emergency Alert Signal / Alternative).

Depending on how the EAS/ALT IF terminal strip (in the rear-panel and shown below) is wired, the unit will over-ride its RF Analog output and will replace it with the incoming EAS/ALT signal.

AUTOMATIC: If the EAS/ALT IF terminal strip is wired as shown, the incoming EAS/ALT will automatically over-ride the RF analog output, PROVIDED HOWEVER, that the EAS/ALT IF signal is equal or greater than +38 dBmV.

MANUAL: If the EAS/ALT IF terminal strip is wired as shown, the incoming EAS/ALT will over-ride the RF analog output.

Automatic

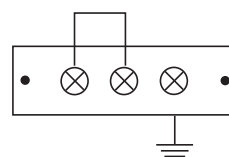

Manual

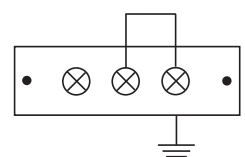

4.6 Sub-Band Input

The sub-band input feature consists of a block converter placed before the product's main RF input. The converter translates the entire T-channel band (5-50 MHz) to the high VHF TV band (173-218 MHz), and presents this as the sub-band converter output on the rear panel. This output is coupled via a short coax jumper to the basic product's RF input. The converter local oscillator operates at a frequency of 168.25 MHz. Therefore, at the output of the converter, standard "T" channels appear as channel "7" for "T-7", channel "8" for "T-8", and so on. Selection of the appropriate T-channel to be processed is made via the front panel following the channel "7" settings for T-7, channel "8" settings for T-8, and so on.

The sub-channel converter has a conversion loss of approximately 8 dB. Therefore, a nominal input signal level to the sub-band converter should be between 3 and 23 dBmV to ensure proper operation.

Connections for Sub-Band Options

1. Set the Sub-Band selector located on the back panel to the ON position.
2. Connect the cable containing the Sub-Band channels (T-7 thru T-13) to the Sub-Band input.
3. Using the supplied loop-thru cable, connect the Sub-Band RF out to the RF input.
4. Set input channel plan to standard.
5. Tune input channel to match sub channel (T7 or 7, T8 or 8, etc.)
6. Set desired output channel. See sections 4.2 and 5.4.

Section 5 – Advanced Configuration

In this Section we provide an explanation of the “parameter values” described in Section 4.1, and instructions on how to change them.

Sections 5.1 through 5.11 describe parameters related to the INPUT signal. Some of these parameters are read-only, and some can be modified by the operator.

Sections 5.12 through 5.17 describe parameters related to the controller circuit-board of the unit itself. All of these parameters are read-only.

Sections 5.18 through 5.21 describe parameters related to the OUTPUT signal. One parameter is read-only, and the remaining parameters can be modified by the operator.

Section 5.22 describes parameters related to the AFD (Active Format Description) menu. AFD is only available on DAP PLUS.

5.1 “INPUT DEMOD MODE” parameter (D-A mode only)

Two (2) options are available: 8VSB and QAM B.

The factory default is 8VSB.

The AP can lock to a terrestrial (broadcast or off-air) 8VSB or CATV QAM Annex B modulated RF input signal. You must select an appropriate signal type to ensure signals are properly identified during a scan.

If INPUT DEMOD MODE = 8VSB, then the unit automatically sets the INPUT CH PLAN = Broadcast.

If INPUT DEMOD MODE = QAM B, then the unit automatically sets the INPUT CH PLAN = STANDARD TV.

See Section 5.2 for details on INPUT CH PLAN.

To change the factory default value, follow these steps:

- (1) Use the **(UP)** or **(DN)** buttons to toggle between the “parameter fields” until you see the “INPUT DEMOD MODE” field on the LCD screen.
- (2) Press and hold for three seconds the **(ENTER)** button. The default value will flash, indicating that you can enter a new parameter. Use the **(UP)** or **(DN)** buttons to select the desired parameter.
- (3) Press the **(ENTER)** button to enter and lock the new parameter. The following message will then appear on the LCD screen, prompting you to re-scan:

MODE CHANGED
PLEASE RE-SCAN



A SCAN MUST BE PERFORMED EACH TIME THE “INPUT DEMOD MODE” IS CHANGED.

See section 5.3 on how to perform a scan.

5.2 “INPUT CH PLAN” parameter

Four (4) options are available: Broadcast, Standard CATV, HRC, and IRC.

The factory default is Broadcast.

BROADCAST option must be selected for terrestrial (broadcast or off-air) 8VSB reception - this option is automatically selected when you set the INPUT DEMOD MODE to 8VSB (See Section 5.1). Reception is limited to VHF & UHF frequencies.

STANDARD CATV option is capable of locking to 8VSB and QAM Annex B signals with “standard” carrier center-frequency - this option is automatically selected when you set the INPUT DEMOD MODE to QAM B (See Section 5.1). Reception is limited to CATV frequencies.

HRC (Harmonically Related Carrier) and IRC (Incrementally Related Carrier) options are capable of locking to QAM Annex B signals with “off-center ” carrier center-frequency.

To change the factory default value, follow these steps:

- (1) Use the **(UP)** or **(DN)** buttons to toggle between the “parameter fields” until you see the “INPUT CH PLAN” field on the LCD screen.
- (2) Press and hold for three seconds the **(ENTER)** button. The cursor will flash, indicating that you can enter a new parameter. Use the **(UP)** or **(DN)** buttons to select the desired parameter.
- (3) Press the **(ENTER)** button to enter and lock the new parameter. The following message will then appear on the LCD screen to confirm your selection:



ENTRY
ACCEPTED

5.3 “SCAN MENU” (D-A mode only)

Four (4) options are available: Exit, Yes, Status, Stop Scan.

You must perform a scan so that the unit can search and find all available channels present on the input signal.

EXIT allows you to exit the scan menu without making any modifications.

YES performs a scan of the incoming available signals.



ONCE A NEW SCAN IS IN PROCESS ALL PREVIOUSLY SCANNED AND STORED CHANNELS ARE ERASED. USE OF KEY-PAD IS NOT ALLOWED, BUT IF ATTEMPTED A “SCAN IN PROCESS” MESSAGE WILL BE DISPLAYED ON THE LCD SCREEN.

STATUS displays the channels found during the scan process.

STOP SCAN allows you to stop an on-going scan.



ONCE A NEW SCAN IS IN PROCESS ALL PREVIOUSLY SCANNED AND STORED CHANNELS ARE ERASED. IF THE SCAN IS STOPPED, ONLY A PARTIAL LIST OF CHANNELS WILL BE AVAILABLE FOR SELECTION.

To change the factory default value, follow these steps:

- (1) Use the **(UP)** or **(DN)** buttons to toggle between the “parameter fields” until you see the “SCAN MENU” field on the LCD screen.
- (2) Press and hold for three seconds the **(ENTER)** button. The default value will flash, indicating that you can enter a new parameter. Use the **(UP)** or **(DN)** buttons to select the desired parameter.
- (3) Press the **(ENTER)** button to enter and lock the new parameter.



SEE NOTE IN SECTION 4.2 CONCERNING THE SCANNED DATABASE

5.4 “INPUT (TUNE) CHANNEL” parameter

The INPUT CHANNEL allows you to select or enter a desired channel. The Digital-to-Analog mode has a list of “clear and un-encrypted” channels after the unit has scanned and stored the data for all such available channels. Both the Digital-to-Digital and Analog-to-Analog require direct entry of the desired RF input channel.

To select a desired program, follow these steps:

- (1) Use the **(UP)** or **(DN)** buttons to toggle between the “parameter fields” until you see the “INPUT CHANNEL” field on the LCD screen.
- (2) Press and hold for three seconds the **(ENTER)** button. The cursor will flash, indicating that you can enter a new parameter.
- (3) Use the navigation buttons **(UP)**, **(DN)**, **(L)** and **(R)** to set the desired channel. In Digital to Analog mode press **(UP)** button first to view first channel in scanned database.
- (4) Press the **(ENTER)** button to enter and lock the new channel. The following message will then appear on the LCD screen to confirm your selection:



- (5) In the Digital to Analog mode (only) a “banner” will appear for approximately 10 seconds on all TV sets indicating the Major-channel number, its Sub-channel number and designation, and the time of day as received from the input stream.

5.5 “CHANNEL INFO” parameter (D-A mode only)

This is a read-only screen and displays the following information as received from the input stream:

- Picture Aspect Ratio: typically 16:9 or 4:3
- Input Signal Mode: typically 8VSB, or Q64 (QAM 64), or Q256
- Channel Number: for example 101
- Center Frequency of the channel above: for example 657 MHz in the case of Ch. 101

5.6 “PICTURE SHAPE” parameter (D-A mode only)

Six (6) options are available: Full, Letter Box, Center Cut, Zoom1, Zoom2, and SmartZoom1.

The factory default value is Zoom2.

You can adjust the picture’s aspect ratio to the desired setting for converting 16:9 images to 4:3 images as required for traditional television ratio viewing.



IF THE INCOMING IMAGE HAS AN ASPECT RATIO OF 4:3, THEN THE FOLLOWING MESSAGE IS DISPLAYED ON THE LCD SCREEN TO INDICATE THAT NO PICTURE IMPROVEMENT IS MADE BY CHANGING THE ASPECT RATIO.



FULL displays the entire picture while stretching it vertically to fit the TV screen and may result in black bars on the sides of the TV screen.

LETTER BOX displays the entire picture image and may result in black bars on top/bottom and left/right of the TV screen.

CENTER CUT expands the image to fit the TV screen while cropping some images on the left/right and typically results in no black bars on the screen.

ZOOM1 results in vertical/horizontal cut with black bars.

ZOOM2 results in vertical/horizontal cut without black bars.

SMARTZOOM1 is a modified version of Zoom1 to adjust for differences in the picture shape data sent by a broadcaster.

See Appendix A for pictorial samples. To choose any of the available options, follow these steps:

- (1) Use the **(UP)** or **(DN)** buttons to toggle between the “parameter fields” until you see the “PICTURE SHAPE” field on the LCD screen.
- (2) Press and hold for three seconds the **(ENTER)** button. The default value will flash, indicating that you can enter a new parameter. Use the **(UP)** or **(DN)** buttons to select the desired parameter.
- (3) Press the **(ENTER)** button to enter and lock the new parameter. The following message will then appear on the LCD screen to confirm your selection:

ENTRY
ACCEPTED



THIS FEATURE IS DISABLED IF THE AFD OPTION IS ENABLED. SEE "AFD MENU" IN SECTION 5.22.

5.7 “OUTPUT AUDIO” parameter (D-A mode only)

The range is from 0 to 100%.

The factory default value is 100%.

To change the factory default value, follow these steps:

- (1) Use the **(UP)** or **(DN)** buttons to toggle between the “parameter fields” until you see the “OUTPUT AUDIO” field on the LCD screen.
- (2) Press and hold for three seconds the **(ENTER)** button. The 3-digit percentage field will flash, indicating that you can enter a percentage. Use the **(UP)** or **(DN)** buttons to enter the first digit of the desired audio percentage. For example, if you want to enter 98% (098%), then you must enter digit (0).
- (3) Use the **(R)** button to change the position of the cursor and move it to the second position of the percentage. Then use the **(UP)** or **(DN)** buttons to enter the second digit of the audio percentage – digit (9) in the case of 98%.
- (4) Repeat step 3 above until all desired digits are entered.
- (5) Once all the digits of the desired percentage are entered, press the **(ENTER)** button to enter and lock the value. The following message will then appear on the LCD screen to confirm your selection:

ENTRY
ACCEPTED

5.8 “AUDIO LANGUAGE” parameter (D-A mode only)

Two (2) options are available: Primary and SAP (Secondary Audio Program).

The factory default value is Primary.

Any program will always contain a primary audio channel, for example English (displayed as “eng” on the LCD screen). Depending on the input source, a program may also contain a SAP as an auxiliary audio channel. SAP is often used for an alternate language, for example, Spanish.

To change the factory default value, follow these steps:

- (1) Use the **(UP)** or **(DN)** buttons to toggle between the “parameter fields” until you see the “AUDIO LANGUAGE” field on the LCD screen.
- (2) Press and hold for three seconds the **(ENTER)** button. The default value will flash, indicating that you can enter a new parameter. Use the **(UP)** or **(DN)** buttons to select the desired parameter
- (3) Press the **(ENTER)** button to enter and lock the new parameter.



BROADCASTING OF SAP IS NOT WIDELY PRACTICED YET. MANY PROGRAMS MAY NOT INCLUDE A SAP. MANY PROGRAMS THAT DO INCLUDE A SAP, MAY HAVE IT IN THE SAME LANGUAGE OF THE PRIMARY AUDIO.

5.9 “CC: EIA-608” parameter (D-A mode only)

Two (2) options are available: Enabled, and Disabled.

The factory default value is Disabled.

This is the Closed Captioning option. The Closed Captioning, also known as line 21 captions per EIA-608, is the standard for Closed Captioning for NTSC broadcasts in the United States. You can globally enable or disable Closed Captioning, eliminating the need to adjust individual TV sets.

To choose any of the available options, follow these steps:

- (1) Use the **(UP)** or **(DN)** buttons to toggle between the “parameter fields” until you see the “CC: EIA-608” field on the LCD screen.
- (2) Press and hold for three seconds the **(ENTER)** button. The default value will flash, indicating that you can enter a new parameter. Use the **(UP)** or **(DN)** buttons to select the desired parameter.
- (3) Press the **(ENTER)** button to enter and lock the new parameter. The following message will then appear on the LCD screen to confirm your selection:

ENTRY
ACCEPTED

5.10 “INPUT POWER RESET” parameter

Two (2) options are available: Exit, and Yes.

This is to power-cycle all the internal circuit-boards of the unit pertaining to the processing of the input signal.

To choose any of the available options, follow these steps:

- (1) Use the **(UP)** or **(DN)** buttons to toggle between the “parameter fields” until you see the “INPUT POWER RESET” field on the LCD screen.
- (2) Press and hold for three seconds the **(ENTER)** button. The default value will flash, indicating that you can enter a new parameter. Use the **(UP)** or **(DN)** buttons to select the desired parameter.
- (3) Press the **(ENTER)** button to enter and lock the new parameter. The following message will then appear on the LCD screen to confirm your selection:

ENTRY
ACCEPTED

5.11 “DIGITAL INPUT” parameter

This is a read-only screen and displays the firmware version of the “digital circuit-board” of the unit.

5.12 “AP ADDRESS” parameter

This is a read-only screen and displays the 8-digit address of the unit, for example 00012345.

5.13 “CONTROL MODULE” parameter

This is a read-only screen and displays the firmware version of the “controller circuit-board” of the unit.

5.14 “3.3 VDC INPUT” parameter

This is a read-only screen and displays the actual DC voltage sent from the “controller circuit-board” to the “digital circuit-board” of the unit. The normal operating range is from 2.97 to 3.63 VDC.

5.15 “6 VDC INPUT” parameter

This is a read-only screen and displays the actual DC voltage sent from the “controller circuit-board” to the “digital circuit-board” of the unit. The normal operating range is from 5.4 to 6.6 VDC.

5.16 “12 VDC INPUT” parameter

This is a read-only screen and displays the actual DC voltage sent from the “controller circuit-board” to the “analog circuit-board” of the unit. The normal operating range is from 10.8 to 13.2 VDC.

5.17 “21 VDC INPUT” parameter

This is a read-only screen and displays the actual DC voltage sent from the “controller circuit-board” to the “analog circuit-board” of the unit. The normal operating range is from 18.9 to 23.1 VDC.

5.18 “ANALOG MODULE” parameter

This is a read-only screen and displays the firmware version of the “analog circuit-board” of the unit, for example:

FIRMWARE V:1.1

5.19 “OUTPUT CHANNEL MODE” parameter

Four (4) options are available: Standard CATV, Frequency, HRC, and IRC.

The factory default is Standard CATV.

This identifies the mode in which the output channel can be selected (see Section 5.21 for details).

STANDARD CATV allows you to select the output channel by its designated NTSC channel number, i.e. channel 2 or 135.
 HRC and IRC allow you to select the output channel by its designated “off-set” HRC or IRC video frequency.
 FREQUENCY allows you to select the output channel by frequency.

To change the factory default value, follow these steps:

- (1) Use the **(UP)** or **(DN)** buttons to toggle between the “parameter fields” until you see the “OUTPUT CHANNEL MODE” field on the LCD screen.
- (2) Press and hold for three seconds the **(ENTER)** button. The default value will flash, indicating that you can enter a new parameter. Use the **(UP)** or **(DN)** buttons to select the desired parameter
- (3) Press the **(ENTER)** button to enter and lock the new parameter. The following message will then appear on the LCD screen to confirm your selection:



5.20 “OUTPUT LEVEL” parameter

This is the output power level of the RF channel. The range is from 50 to 62 dBmV, in 0.2 dBmV increments for Analog output and 45 to 57 dBmV for QAM output.

The factory default value is 60 dBmV when operating with an analog output and 55 dBmV with a QAM output.

- (1) Use the **(UP)** or **(DN)** buttons to toggle between the “parameter fields” until you see the “OUTPUT LEVEL” field on the LCD screen.
- (2) Press and hold for three seconds the **(ENTER)** button. The 3-digit output level field will flash, indicating that you can enter a new level. Use the **(UP)** or **(DN)** buttons to enter the first digit of the desired output level. For example, if you want to enter 59.8 dBmV, then you must enter digit (5).
- (3) Use the **(R)** button to change the position of the cursor and move it to the second position of the output level. Then use the **(UP)** or **(DN)** buttons to enter the second digit of the output level – digit (9) in the case of 59.8 dBmV.
- (4) Repeat step 3 above until all desired digits are entered.
- (5) Once all the digits of the desired output level are entered, press the **(ENTER)** button to enter and lock the value. The following message will then appear on the LCD screen to confirm your selection:



5.21 “RF OUTPUT” parameter

This is the channel number on which the RF will appear on a TV set. The factory default value is NTSC channel 3.

If in Section 5.19 you had selected OUTPUT CH MODE = STANDARD CATV, then you can set the output here by its designated NTSC channel number, for example channel 2 or 135.

To select a new channel number, follow these steps:

- (1) Use the **(UP)** or **(DN)** buttons to toggle between the “parameter fields” until you see the “ANALOG RF OUT” field on the LCD screen.
- (2) Press and hold for three seconds the **(ENTER)** button. The 3-digit channel number cursor will flash, indicating that you can enter a new channel number. Use the **(UP)** or **(DN)** buttons to enter the first digit of the desired channel number. For example, if you want to enter channel 24 (024), then you must enter digit (0).
- (3) Use the **(R)** button to change the position of the cursor and move it to the second position of the channel number. Then use the **(UP)** or **(DN)** buttons to enter the second digit of the number – digit (2) in the case of channel 24 (024).
- (4) Repeat step 3 above until all desired digits are entered.
- (5) Once all the digits of the desired channel number are entered, press the **(ENTER)** button to enter and lock the value. The following message will then appear on the LCD screen to confirm your selection:



ENTRY
ACCEPTED

If in Section 5.19 you had selected OUTPUT CH MODE = FREQUENCY, or HRC, or IRC, then you can set the output here by its designated video center-frequency. Follow the steps above to enter the desired frequency value.

5.22 “AP MODE”

The channel processor has three (3) operating modes.

The Digital to Analog mode receives one 8VSB or QAM (64/256) input and outputs one NTSC analog RF output channel in the 54-860 MHz range. This mode is used in applications that have a digital input from a broadcast station or a cable feed and require viewing on existing analog TV’s. Common applications are found in lodging and educational facilities.

The Digital to Digital mode receives one QAM (64/256) input and outputs one QAM RF output channel in the 54-860 MHz range. Cherry-picking CATV clear QAM channels are the most common applications for this mode. The unit can also process a QAM modulated remote origination sub channel using its’ built in sub-channel block converter feature.

The AP-60-860A is not designed to process 8VSB to 8VSB signals. The Blonder Tongue model DHDP-50 should be used for 8VSB to 8VSB processing.

The Analog to Analog mode receives one NTSC analog channel and outputs one NTSC analog channel between 54 and 860 MHz. This mode is used for processing off-air analog channels from LPTV or translators (that have not transitioned to digital), CATV analog cherry-picking and analog sub-channel remote originations.

Appendix A: Screen Aspect Ratio

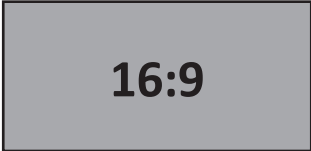
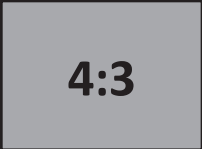

LETTERBOX

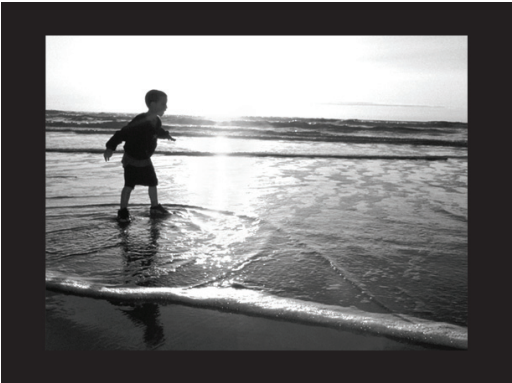

Displays the entire picture image while fitting the picture to the screen by applying bars to the top and bottom of the screen.

FULL



Displays the entire picture image while fitting the picture to the screen by stretching the image vertically, so that it fits the screen. Black bars are present on the sides and there may be a slight distortion of the picture.

ZOOM 1 (Smart Zoom 1)



Expands the picture image to fit the screen while cropping some images on the left and right. This mode will still show very thin black bands at the left and right of the screen.

Center Cut



Expands the picture image to fit the screen while cropping some images on the left and right w/o displaying any bars on the screen.

NOTE:

- It is recommended to use the Center Cut setting for maximum screen usage when converting 16:9 aspect ratio signals for viewing on 4:3 televisions, the primary use of the DAP.

Appendix B: Glossary of Useful Terms & Acronyms

Glossary of Useful Terms and Acronyms

AFD — Active Format Description (AFD) is a standard set of codes that can be sent in the MPEG video stream or in the baseband SDI video signal that carries information about the video's aspect ratio and active picture characteristics. It has been used by television broadcasters to enable both 4:4 and 16:9 television sets to optimally present pictures transmitted in either format. It has also been used by broadcasters to dynamically control how down-conversion equipment formats widescreen 16:9 pictures for 4:4 displays.

Standard AFD codes provide information to video devices about where in the coded picture the active video is and also the "protected area" which is the area that needs to be shown. Outside of the protected area, edges at the sides or the top can be removed without the viewer missing anything significant. Video decoders and display devices can then use this information, together with knowledge of the display shape and user preferences, to choose a presentation mode. AFD codes are not part of the core MPEG standard; they are a DVB extension, which has subsequently also been adopted, with some changes, by ATSC.

Anamorphic Stretching — Anamorphic widescreen is a cinematography and photography technique for capturing a widescreen picture on standard 35mm film, or other visual recording media with a non-widescreen native aspect ratio. It can also refer to a related technique for maximizing picture quality in DVD video recordings.

ASI — Asynchronous Serial Interface (ASI) is a streaming data format which often carries an MPEG Transport Stream (MPEG-TS). It is electrically identical to an (SDI) Serial Digital Interface signal and is always 270Mbit/s. There are two transmission formats commonly used by the ASI interface, the 188 byte format and the 204 byte format. The 188 byte format is the more common ASI transport stream. When optional data is included, the packet can stretch an extra 16 bytes to 204 bytes total.

Aspect Ratio — The aspect ratio of an image is its displayed width divided by its height (usually expressed as "x:y"). For instance, the aspect ratio of a traditional television screen is 4:3 (a ratio of four units wide to three units tall). High-definition television and European digital television use an aspect of 16:9.

ATSC — Advanced Television Systems Committee (ATSC) is the group, established in 1982, that developed the eponymous ATSC Standards for digital television in the United States, also adopted by Canada, Mexico, South Korea and Honduras, and is being considered by other countries.

ATSC Standards — Document a digital television format (Developed by ATSC) that will have replaced the analog NTSC television system by February 17, 2009 in the United States, and August 31, 2011 in Canada.

The high definition television standards defined by the ATSC produce wide screen 16:9 images with up to 1920×1080 pixels in size — more than six times the display resolution of the earlier standard. However, a host of different image sizes is also supported, so that up to six standard-definition channels can be broadcast on a single 6 MHz TV Channel.

ATSC also boasts "theater quality" audio because it uses the Dolby Digital AC-3 format to provide 5.1-channel surround sound. Numerous auxiliary data-casting services can also be provided.

Closed Captions — Closed captions are text versions of the audio content or may provide other information while you are watching a program. Actual content is decided by the broadcaster.

DVB — Digital Video Broadcasting (DVB) is a suite of internationally accepted open standards for digital television. These standards define the physical layer and data link layer of the distribution system. Devices interact with the physical layer via a synchronous parallel interface (SPI), synchronous serial interface (SSI), or asynchronous serial interface (ASI). All data is transmitted in MPEG-2 transport streams with some additional constraints (DVB-MPEG).

HDTV — High Definition Television. HDTV is a broadcasting format with significantly higher resolution (at least twice that) than that of traditional formats such as NTSC, SECAM & PAL. Signal formats are 1080i (interlaced scan) and 720p (progressive scan) with a widescreen (16:9) aspect ratio as standard. The technical standards for broadcasting HDTV are also able to handle 16:9 aspect ratio pictures without using letterboxing or anamorphic stretching, thus further increasing the effective resolution for such content.

Letterbox — Letterboxing is the practice of transferring widescreen films to video formats while preserving the original aspect ratio. Since the video display is most often a more square aspect ratio than the original film, the resulting video must include masked-off areas above and below the picture area (often referred to as "black bars," or, more accurately, as mattes). Letterboxing takes its name from the similarity of the resulting image to a horizontal opening in a postal letter box. LTBX is an acronym used for programming using this format.

MPEG — The Moving Pictures Experts Group (MPEG) is a working group of the ISO/IEC standard body charged with the development of video and audio encoding standards. Its first meeting was in May 1988 in Ottawa, Canada and has since grown to include approximately 350 from various industries, universities, and research institutions. MPEG's official designation is ISO/IEC JTC1/SC29 WG11.

MPEG 2 — MPEG-2 was the second of several standards developed by the MPEG and is an international standard (ISO/IEC 13818). MPEG-2 is widely used as the format of digital television signals that are broadcast by terrestrial (over-the-air), CATV, and direct broadcast satellite TV systems. It also specifies the format of movies and other programs that are distributed on DVD and similar disks. As such, TV stations, TV receivers, DVD players, and other equipment are often designed to this standard.

QAM — Quadrature Amplitude Modulation is a modulation scheme which conveys data by changing (modulating) the amplitude of two carrier waves. These two waves, usually sinusoids, are out of phase with each other by 90° and are thus called quadrature carriers, hence the name of the scheme. In QAM, the constellation points are usually arranged in a square grid with equal vertical and horizontal spacing, although other configurations are possible. The most common forms are 16-QAM, 64-QAM, 128-QAM and 256-QAM. By moving to a higher-order constellation, it is possible to transmit more bits per symbol.

SDTV — Standard Definition Television. SDTV signal formats are 480p and 480i, they provide lower resolutions than high definition, yet provide a very sharp, clear picture. Lower resolution allows broadcasters to transmit multiple programs per channel. The term SDTV is usually used in reference to digital television, in particular when broadcasting at the same (or similar) resolution as analog systems. Digital SDTV in 4:3 aspect ratio has the same appearance as traditional analog TV.

Sub-Channel — The compression of audio and video signal enables each digital channel to carry different programs on sub-channels. Typically, the main program is on channel 8-1, in the example for channel 8. In this case, 8 is the “major channel”, and 1, 2, or 3 is the sub-channel.

Vestigial Sideband — Vestigial sideband (VSB) is a type of amplitude modulation (AM) technique that encodes data by varying the amplitude of a single carrier frequency. Portions of one of the redundant sidebands are removed to form a vestigial sideband signal - so-called because a vestige of the sideband remains.

8VSB — Developed by Zenith, it is the 8-level vestigial sideband modulation method adopted for terrestrial broadcast of the ATSC digital television standard in the United States and Canada.

Widescreen — A widescreen image is a film, computer, or television image with a wider aspect ratio than the standard Academy frame developed during the classical Hollywood cinema era, often expressed as 4:3.

NOTES

Limited Warranty

Blonder Tongue Laboratories, Inc. (BT) will at its sole option, either repair or replace (with a new or factory reconditioned product, as BT may determine) any product manufactured by BT which proves to be defective in materials or workmanship or fails to meet the specifications which are in effect on the date of shipment or such other specifications as may have been expressly agreed upon in writing (i) for a period of one (1) year from the date of original purchase (or such shorter period of time as may be set forth in the license agreement specific to the particular software being licensed), with respect to iCentral™ (hardware and software) and all other software products (including embedded software) licensed from BT, (ii) for a period of one (1) year from the date of original purchase, with respect to all MegaPort™, IPTV products, and fiber optics receivers, transmitters, couplers and integrated receiver/distribution amplifiers (including TRAILBLAZER™, RETRO-LINX™ and TWIN STAR™ products) as well as for DigiCipher ® satellite receivers, and (iii) for a period of three (3) years from the date of original purchase, with respect to all other BT products. Notwithstanding the foregoing, in some cases, the warranty on certain proprietary sub-assembly modules manufactured by third-party vendors and contained in BT products and on certain private-label products manufactured by third-parties for resale by BT are of shorter duration or otherwise more limited than the standard BT limited warranty. In such cases, BT's warranty with respect to such third-party proprietary sub-assembly modules and private-label products will be limited to the duration and other terms of such third-party vendor's warranty. In addition, certain products, that are not manufactured but are resold by BT, carry the original OEM warranty for such products. The limited warranty set forth in this paragraph does not apply to any product sold by BT, which at the time of sale constituted a Refurbished/Closeout Product.

(b) BT will at its sole option, either repair or replace (with a new or factory-reconditioned product, as BT may determine) any product sold by BT which at the time of sale constituted a refurbished or closeout item ("Refurbished/Closeout Product"), which proves to be defective in materials or workmanship or fails to meet the specifications which are in effect on the date of shipment or such other specifications as may have been expressly agreed upon in writing, for a period of ninety (90) days from the date of original purchase. Notwithstanding the foregoing, in some cases the warranty on third party software and on certain proprietary sub-assembly modules manufactured by third-party vendors and contained in BT products and on certain private-label products manufactured by third-parties for resale by BT are of shorter duration or otherwise more limited than the BT limited warranty for Refurbished/Closeout Products. In such cases, BT's warranty for Refurbished/Closeout Products constituting such third party software, third-party proprietary sub-assembly modules and private-label products will be limited to the duration and other terms of such third-party vendor's warranty. In addition, notwithstanding the foregoing, (i) certain Refurbished/Closeout Products that are not manufactured (but are resold) by BT, carry the original OEM warranty for such products, which may be longer or shorter than the BT limited warranty for Refurbished/Closeout Products. All sales of Refurbished/Closeout Products are final.

To obtain service under this warranty, the defective product, together with a copy of the sales receipt or other satisfactory proof of purchase and a brief description of the defect, must be shipped freight prepaid to: Blonder Tongue Laboratories, Inc., One Jake Brown Road, Old Bridge, New Jersey 08857.

This warranty does not cover damage resulting from (i) use or installation other than in strict accordance with manufacturer's written instructions, (ii) disassembly or repair by someone other than the manufacturer or a manufacturer-authorized repair center, (iii) misuse, misapplication or abuse, (iv) alteration, (v) lack of reasonable care or (vi) wind, ice, snow, rain, lightning, or any other weather conditions or acts of God.

OTHER THAN THE WARRANTIES SET FORTH ABOVE, BT MAKES NO OTHER WARRANTIES OR REPRESENTATIONS OF ANY KIND, EXPRESS OR IMPLIED, AS TO THE CONDITION, DESCRIPTION, FITNESS FOR A PARTICULAR PURPOSE, MERCHANTABILITY, OR AS TO ANY OTHER MATTER, AND SUCH WARRANTIES SUPERSEDE ANY ORAL OR WRITTEN WARRANTIES OR REPRESENTATIONS MADE OR IMPLIED BY BT OR BY ANY OF BT'S EMPLOYEES OR REPRESENTATIVES, OR IN ANY OF BT'S BROCHURES MANUALS, CATALOGS, LITERATURE OR OTHER MATERIALS. IN ALL CASES, BUYER'S SOLE AND EXCLUSIVE REMEDY AND BT'S SOLE OBLIGATION FOR ANY BREACH OF THE WARRANTIES CONTAINED HEREIN SHALL BE LIMITED TO THE REPAIR OR REPLACEMENT OF THE DEFECTIVE PRODUCT F.O.B. SHIPPING POINT, AS BT IN ITS SOLE DISCRETION SHALL DETERMINE. BT SHALL IN NO EVENT AND UNDER NO CIRCUMSTANCES BE LIABLE OR RESPONSIBLE FOR ANY CONSEQUENTIAL, INDIRECT, INCIDENTAL, PUNITIVE, DIRECT OR SPECIAL DAMAGES BASED UPON BREACH OF WARRANTY, BREACH OF CONTRACT, NEGLIGENCE, STRICT TORT LIABILITY OR OTHERWISE OR ANY OTHER LEGAL THEORY, ARISING DIRECTLY OR INDIRECTLY FROM THE SALE, USE, INSTALLATION OR FAILURE OF ANY PRODUCT ACQUIRED BY BUYER FROM BT.

All claims for shortages, defects, and non-conforming goods must be made by the customer in writing within five (5) days of receipt of merchandise, which writing shall state with particularity all material facts concerning the claim then known to the customer. Upon any such claim, the customer shall hold the goods complained of intact and duly protected, for a period of up to sixty (60) days. Upon the request of BT, the customer shall ship such allegedly non-conforming or defective goods, freight prepaid to BT for examination by BT's inspection department and verification of the defect. BT, at its option, will either repair, replace or issue a credit for products determined to be defective. BT's liability and responsibility for defective products is specifically limited to the defective item or to credit towards the original billing. All such replacements by BT shall be made free of charge f.o.b. the delivery point called for in the original order. Products for which replacement has been made under the provisions of this clause shall become the property of BT. Under no circumstances are products to be returned to BT without BT's prior written authorization. BT reserves the right to scrap any unauthorized returns on a no-credit basis. Any actions for breach of a contract of sale between BT and a customer must be commenced by the customer within thirteen (13) months after the cause of action has accrued. A copy of BT's standard terms and conditions of sale, including the limited warranty, is available from BT upon request. Copies of the limited warranties covering third-party proprietary sub-assembly modules and private-label products manufactured by third-parties are also available from BT on request. DigiCipher ® is a registered trademark of Motorola Corp. (Rev 0509)



**BLONDER
TONGUE**
LABORATORIES, INC.

One Jake Brown Road
Old Bridge, NJ 08857-1000 USA
(800) 523-6049 • (732) 679-4000 • FAX: (732) 679-4353
www.blondertongue.com