

SB-6335R4

4-Play HDBaseT™ RECEIVER up to 330 Feet (100M)
(Single LAN, 2-way IR, RS-232, HDMI)



IMPORTANT WARRANTY INFORMATION.

If you remove the HDMI screw posts, you must use the provided HDMI Locking Post replacement screws to keep the internal HDMI jack secure. Removing the HDMI screws without installing the HDMI Locking Post replacement screws will void your warranty.



SAFETY INFORMATION



1. To ensure the best results from this product, please read this manual and all other documentation before operating your equipment. Retain all documentation for future reference.
2. Follow all instructions printed on unit chassis for proper operation.
3. To reduce the risk of fire, do not spill water or other liquids into or on the unit, or operate the unit while standing in liquid.
4. Make sure power outlets conform to the power requirements listed on the back of the unit. Keep unit protected from rain, water and excessive moisture.
5. Do not attempt to clean the unit with chemical solvents or aerosol cleaners, as this may damage the unit. Dust with a clean dry cloth.
6. Do not use the unit if the electrical power cord is frayed or broken. The power supply cords should be routed so that they are not likely to be walked on or pinched by items placed upon or against them, paying particular attention to cords and plugs, convenience receptacles, and the point where they exit from the appliance.
7. Do not force switched or external connections in any way. They should all connect easily, without needing to be forced.
8. Always operate the unit with the AC ground wire connected to the electrical system ground. Precautions should be taken so that the means of grounding of a piece of equipment is not defeated.
9. AC voltage must be correct and the same as that printed on the rear of the unit. Damage caused by connection to improper AC voltage is not covered by any warranty.
10. Turn power off and disconnect unit from AC current before making connections.
11. Never hold a power switch in the "ON" position.
12. This unit should be installed in a cool dry place, away from sources of excessive heat, vibration, dust, moisture and cold. Do not use the unit near stoves, heat registers, radiators, or other heat producing devices.
13. Do not block fan intake or exhaust ports. Do not operate equipment on a surface or in an environment which may impede the normal flow of air around the unit, such as a bed, rug, carpet, or completely enclosed rack. If the unit is used in an extremely dusty or smoky environment, the unit should be periodically "blown free" of foreign dust and matter.
14. To reduce the risk of electric shock, do not remove the cover. There are no user serviceable parts inside. Refer all servicing to qualified service personnel. There are no user serviceable parts inside.
15. When moving the unit, disconnect input ports first, then remove the power cable; finally, disconnect the interconnecting cables to other devices.
16. Do not drive the inputs with a signal level greater than that required to drive equipment to full output.
17. The equipment power cord should be unplugged from the outlet when left unused for a long period of time.
18. Save the carton and packing material even if the equipment has arrived in good condition. Should you ever need to ship the unit, use only the original factory packing.
19. Service Information Equipment should be serviced by qualified service personnel when:
 - A. The power supply cord or the plug has been damaged.
 - B. Objects have fallen, or liquid has been spilled into the equipment.
 - C. The equipment has been exposed to rain.
 - D. The equipment does not appear to operate normally, or exhibits a marked change in performance.
 - E. The equipment has been dropped, or the enclosure damaged.

TABLE OF CONTENTS

HDMI-HDBaseT™ EXTENDER Series

Thank you for purchasing the SB-6335R4 HDMI-HDBaseT™ with Ethernet Receiver. You will find this unit easy to install and highly reliable but it is essential that you read this manual thoroughly before attempting to use HDBaseT™ Extender.

CONTENTS

INTRODUCTION	1
FEATURES & SPECIFICATIONS	2
PACKAGE CONTENTS	2
TYPICAL HOOKUP & OPERATION	3
IR EXTENDER	4
RACK MOUNT	6

INTRODUCTION

Congratulations on your purchase of one of the most innovative HDMI over HDBaseT™ with Ethernet Receivers on the market today. The SB-6355R4 HDBaseT™ Receiver can receive HDMI, IR in/out, RS-232 in/out and Ethernet signals from the HDBaseT™ Transmitter via a single category cable for long distances up to 328 feet (100M) maximum. The SB-6335R4 uses a single category LAN cable CAT6, CAT6a or CAT7 (UTP or FTP) with RJ-45 8P8C connectors and supports the 568a or 568b color specification table. This HDBaseT™ receiver provides higher quality full HD HDMI resolutions of 480i/p, 720p, 1080i/p that are identical to the source and to the HD destination display. Controls and receives HDMI digital video, digital multi-channel audio signals, IR in/out, Bi-directional RS-232 series interface in or out and Ethernet series interface control via a single category cable from the HDBaseT™ Transmitter.

CONFORMANCE TEST REPORT

FOR **EN 61000-6-1 / EN 61000-6-3** 
REPORT NUMBER: 09-07-MAS-282-18-R

FOR **FCC 47 CFR/Part 15 Subpart B** 
REPORT NUMBER: 09-07-MAS-282-19-R

Model Number: SB-6335R4

Comment Number: SB-6215, SB-6215R, SB-6215RE, SB-6220R SB-6220RE,
SB-6240R, SB-6240RE, SB-6335, SB-6335R, SB-6320, SB-6320R

Input: HDBaseT™ CAT6/6a/7 single cable
Output: HDMI & Ethernet series interface
Power Input: +DC12V, 2A 



LOOK A PUPPY!! NOW READ THIS!!



IMPORTANT WARRANTY INFORMATION.

If you remove the HDMI screw posts, you must use the provided HDMI Locking Post replacement screws to keep the internal HDMI jack secure. Removing the HDMI screws without installing the HDMI Locking Post replacement screws will void your warranty.

SAFETY PRECAUTIONS

Please read all instructions before attempting to unpack, install or operate this equipment and before connecting the power supply. Please keep the following in mind as you unpack and install this equipment:

- Always follow basic safety precautions to reduce the risk of fire, electrical shock and injury to persons.
- To prevent fire or shock hazard, do not expose the unit to rain, moisture or install this product near water.
- Never spill liquid of any kind on or into this product.
- Never push an object of any kind into this product through any openings or empty slots in the unit, as you may damage parts inside the unit.
- Do not attach the power supply cabling to building surfaces.
- Use only the supplied power supply unit (PSU). Do not use the PSU if it is damaged.
- Do not allow anything to rest on the power cabling or allow any weight to be placed upon it or any person walk on it.
- To protect the unit from overheating, do not block any vents or openings in the unit housing that provide ventilation and allow for sufficient space for air to circulate around the unit.

DISCLAIMERS

The information in this manual has been carefully checked and is believed to be accurate. We assume no responsibility for any infringements of patents or other rights of third parties which may result from its use.

We assume no responsibility for any inaccuracies that may be contained in this document. We make no commitment to update or to keep current the information contained in this document.

We reserve the right to make improvements to this document and/or product at any time and without notice.

COPYRIGHT NOTICE

No part of this document may be reproduced, transmitted, transcribed, stored in a retrieval system, or any of its part translated into any language or computer file, in any form or by any means — electronic, mechanical, magnetic, optical, chemical, manual, or otherwise — without express written permission and consent.

© Copyright 2016. All Rights Reserved.

Version 2.2 JULY 2016

TRADEMARK ACKNOWLEDGMENTS

All products or service names mentioned in this document may be trademarks of the companies with which they are associated.

FEATURES & SPECIFICATIONS

FEATURES

- HDBaseT™ HDMI Receiver over a single CAT6/6a/7 category LAN cable
- Extends for HDMI, IR in/out, RS-232 in/out and Ethernet ports, with HDCP compliant
- Uses CAT6, CAT6a and CAT7 UTP/FTP category cable
- Supports link speeds of up to 3.4Gbps
- Supports Digital RGB 36bits, V1.4a HDMI TMDS format
- Extends higher quality DVI video 1920x1200 resolutions
- Supports HD High Definition full range resolutions 480p, 720p 1080i/1080p
- Supports long distances up to 328 ft/100M between the HDBaseT™ Transmitter and the HDBaseT™ Receiver
- Supports wall mount pack and rack mount installations for 19 inch 4U rack mount
- Supports power DC input with low power consumption (Full load 850mA)
- Power supply universal power switch 50/60Hz, 100~240VAC

SPECIFICATIONS

- **Type of Extender:** HDBaseT™ Receiver for HDMI signal over a category LAN Cable
- **Input Signals:** HDMI with Digital Video (TMDS)/Audio 0.5~1.0Vpp, DDC 5Vpp
- **HDBaseT™ Supports:** HDMI Standard, DVI and HDCP Compliant
- **Video Supported:** HDMI and DVI TMDS format for 1920x1200 resolutions up to 3.4Gbps Digital RGB 36bits deep color, 3D 1.4a HDMI format
- **HDMI Audio Out Support:** Multi-channel Audio Formats 5.1 / 7.1, MAT(MLP), Dolby Digital, Dolby TrueHD, Dolby Digital Plus, DTS, DTS-ES 6.1, DTS-HD, DTS-HD-HRA, DTS-HD Master, (PCM-2CH)
- **Ethernet Supported:** (1) Ethernet port (100bps)
- **Category Cable Supported:** CAT6, CAT6a, CAT7 UTP/FTP cable
- **Supports HDMI Resolutions:** 480p, 720p, 1080i/1080p, 4K2K
- **Scan Rate Accepted:** Supports HDMI full HD resolutions; Frequency 24Hz to 60Hz
- **Control:** (1) IR in/out, (1) IR in/out, (1) RS-232 and (1) LAN series interface
- **IR Infrared Frequency:** 38KHz
- **Extend Distance:** Up to 328 ft /100M (CAT6)
- **Safety Approvals:** CE, FCC, VCCI, REACH & WEEE
- **Dimensions (LxWxH):** 5.25 x 5.12 x 1 in
- **Rack Mount:** Uses a total of 10 pcs installed into one 19 inch rack mount
- **Weight:** 1.1 lb (Unit only) / 2.9 lb (Net)
- **Power Consumption:** Max 850mA (Full load 1080p-60Hz signal with use DC12V input)
- **Power Supply:** Power Input +12VDC, 2A, (Universal Type 50/60Hz, 100~240VAC)

As product improvements are continuous, specifications are subject to change and without notice.

PACKAGE CONTENTS

Check that you have the following components:

- SB-6335R4 HDBaseT™ Receiver console
- SB-100 IR Extender Receiver Set
- SB-101 IR Extender Transmitter Set
- SB-100C IR Extender Receiver Cable (6.5ft (2M))
- SB-101C IR Extender Transmitter Cable (6.5ft (2M))
- 1 in High wall mount pack (Part # WM-1INCH-L80MM)
- HDMI Locking Post Replacement Screws
- Users Guide
- AC/DC Adapter: 12VDC/2A (universal power switch 50/60Hz, 100~240VAC)

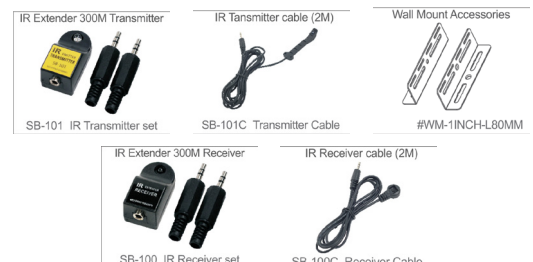

TYPICAL HOOKUP AND OPERATION

SB-6335R4 FRONT

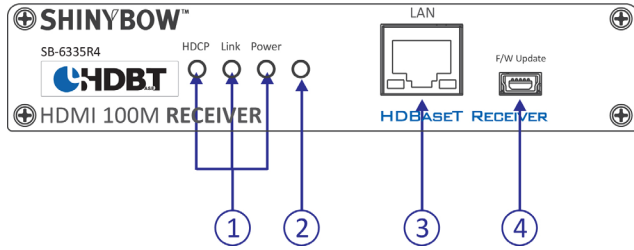

1. STATUS VIA LED SHOW OUT: HDCP, LINK & POWER
2. PoH turns OFF the LED's
3. Ethernet path to the HDBaseT™ Transmitter
4. Firmware update port

SB-6335R4 BACK

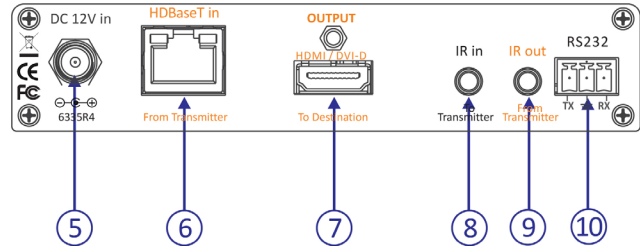

5. DC INPUT: DC12V, 2A
6. RJ-45 IN: HDBaseT™ input, Signal from the HDBaseT™ Transmitter
7. HDMI OUT: HDMI output, Signal to HDMI destination display device
8. IR IN: Sends IR signal to the HDBaseT™ Transmitter
9. IR OUT: Receives IR signal from the HDBaseT™ Transmitter via IR External Receiver SB-100)
10. RS-232 I/O: RS-232 series interface in or out control via a PC

If you remove the HDMI screw posts, you must use the provided HDMI Locking Post replacement screws to keep the internal HDMI jack secure. Removing the HDMI screws without installing the HDMI Locking Post replacement screws will void your warranty.

Safeguards and Precautions

- A. Keep this unit away from fire, extremely hot areas, water or moisture of any kind.
- B. Do not place this unit on any support that is not firm, level and strong.
- C. Do not service the unit yourself. Opening the unit's housing will void the warranty.
- D. Servicing must be by Shinybow or by an authorized technician.
- C. Illegal duplication of copyrighted material is strictly prohibited by Federal Laws.

INSTALLING DIAGRAM

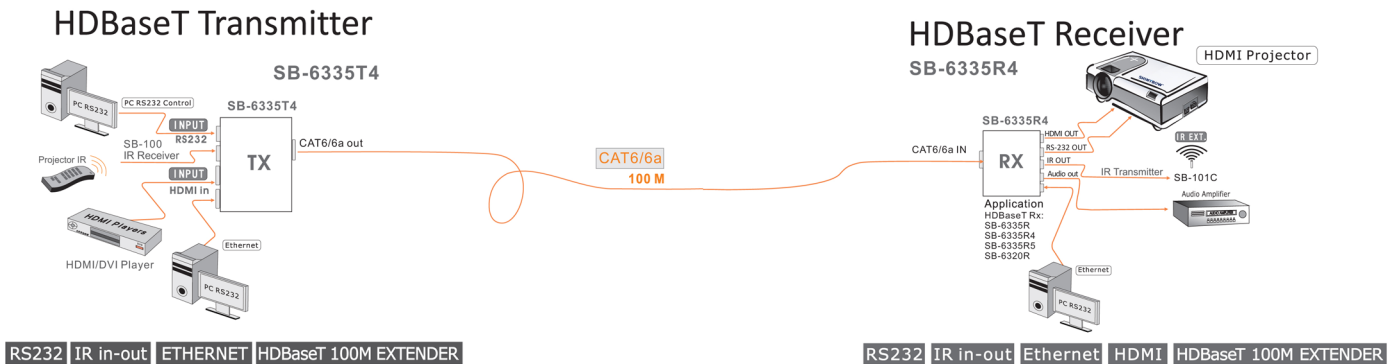

IR EXTENDER

IR EXTENDER

1. SB-100 IR 300M Receiver

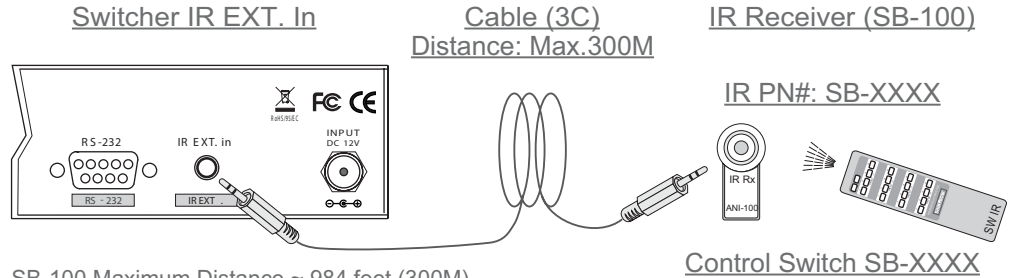

SB-100 Maximum Distance ~ 984 feet (300M)

The SB-100 IR Receiver is required when using the port "ALL in" Jack.

2. SB-100C IR 2M Receiver

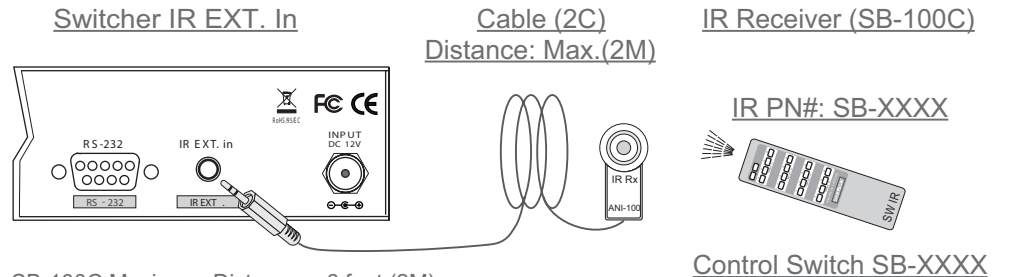

SB-100C Maximum Distance ~ 6 feet (2M)

The SB-100C IR Receiver will not function on the port "ALL in" Jack.

*** When you plug the External IR extender into the switcher, the front panel IR receiver remains active. ***

Pin configuration for IR 984 feet (300M) Extender Receiver such as SB-100 compatible

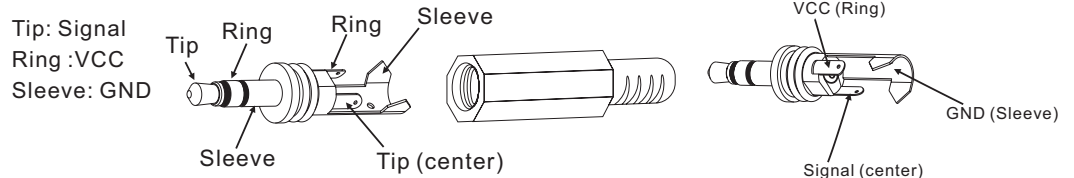

SB-100 Receiver and SB-101 Transmitter The DISTANCE maximum ~ 984 feet (300M)

Pin configuration for IR Receiver 6 feet (2M) cable such as SB-100C compatible

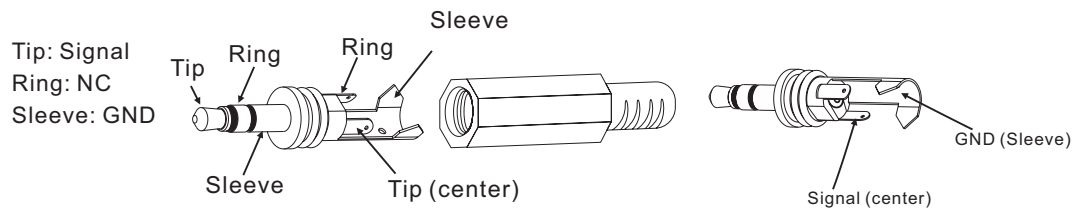

SB-100 Receiver and SB-101C Transmitter The DISTANCE maximum ~ 984 feet (300M)

Note: The External IR jack has voltage on the "Ring" portion of a 3-conductor plug. You must use a 3-conductor plug (aka: stereo plug). Using a 2-conductor plug will short out the power supply. Always make connections with the switcher power off.

IR EXTENDER

IR EXTENDER

1. SB-101 IR 300M Transmitter

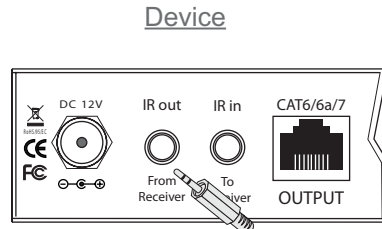

Cable (3C)

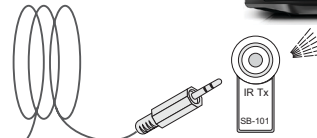

IR Transmitter (SB-101)



SB-101 Maximum Distance ~ 984 feet (300M)

2. SB-101C IR 2M Transmitter

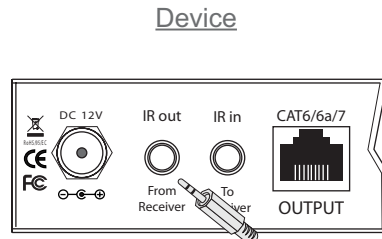

Cable (3C)

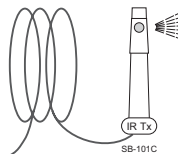

IR Transmitter (SB-101C)



SB-101C Maximum Distance ~ 6 feet (2M)

*** When you plug the External IR extender into the switcher, the front panel IR transmitter remains active. ***

PIN CONFIGURATION:

SB-101 and SB-101C Transmitter Pin configuration

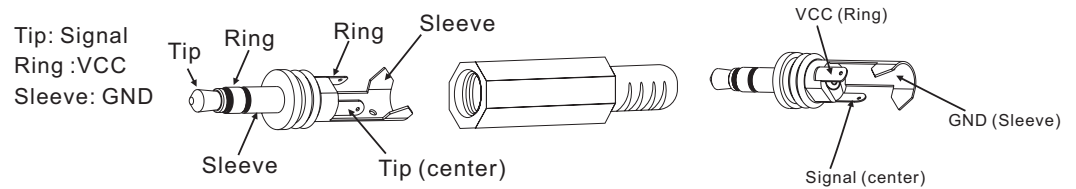

SB-101 Maximum Distance ~ 984 feet (300M)

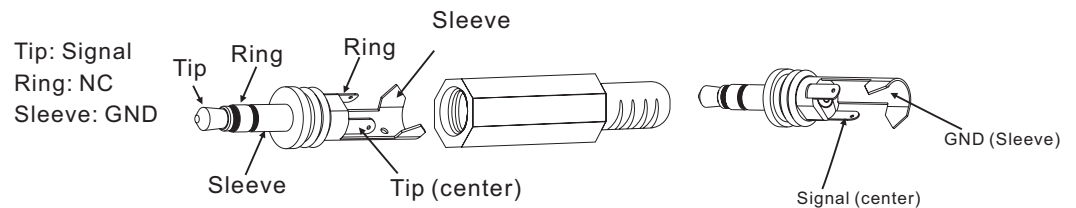

SB-101C Maximum Distance ~ 6 feet (2M)

Note: The External IR jack has voltage on the "Ring" portion of a 3-conductor plug. You must use a 3-conductor plug (aka: stereo plug). Using a 2-conductor plug will short out the power supply. Always make connections with the switcher power off.

RACK MOUNT

SB-6069

SB-6335T4/SB-6335R4 19 INCH 4U-10P RACK MOUNT

Model No.: #4U-10p-L130MM

SB-6335T4/SB-6335R4 4U Ear mount pairs

Parts No.: MEER6069ER13000

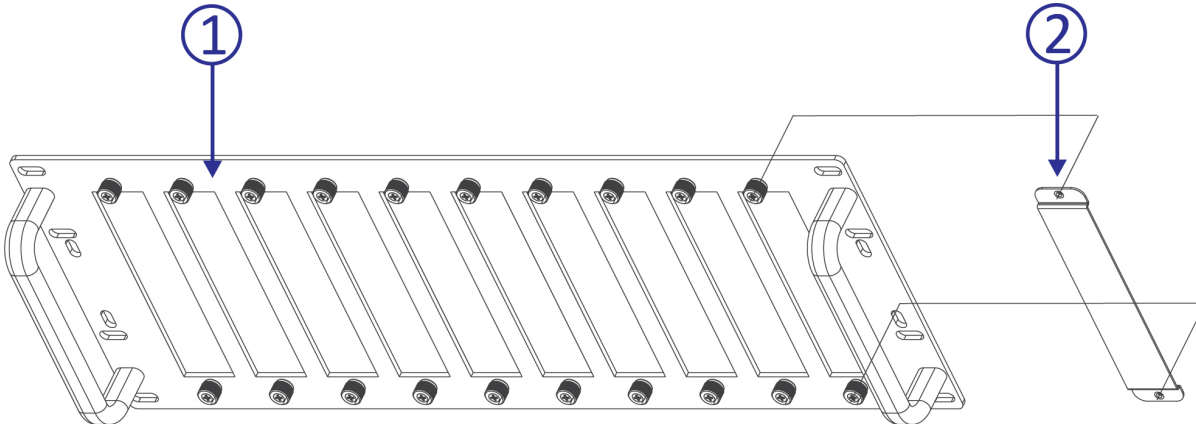

Model No.: #4U-10p-L130MM-COV

SB-6335T4/SB-6335R4 4U Ear mount pairs

Parts No.: MEER6069ER11000

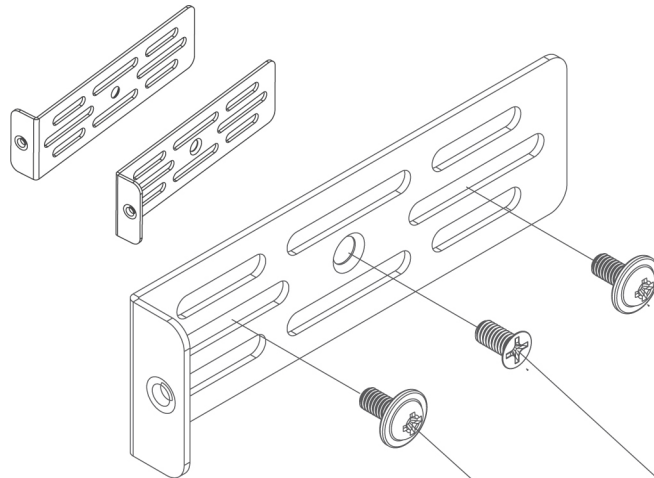
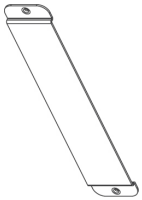

Model No.: #4U-10p-L80MM-EAR

SB-6335T4/SB-6335R4 4U Ear mount pairs

Parts No.: MEER6320ER11001

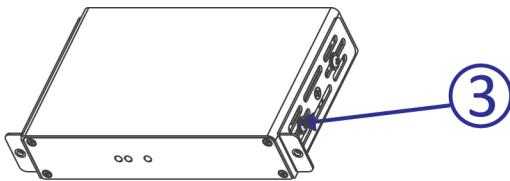

P/N: TP-ISO-M3x6mm(x2)
(MESCW30006ISO02)

P/N: ISO-M3x6mm
(MESCF30006ISO02)

RACK MOUNT

SB-6069

Complete 19 inch 4U rack mount

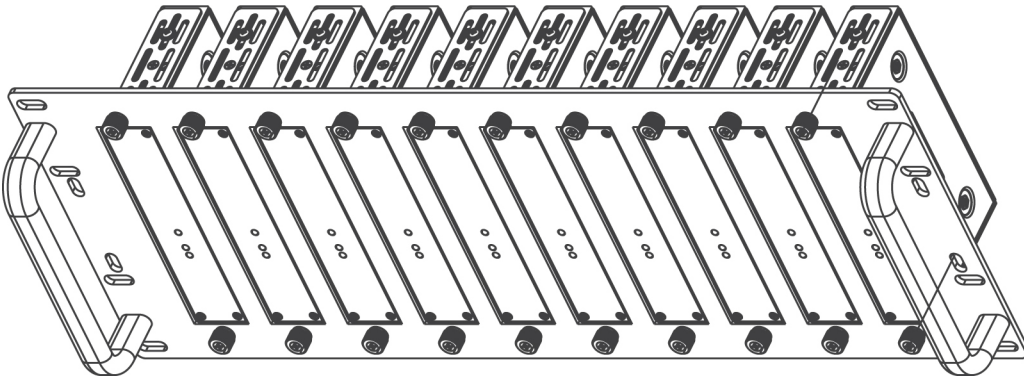

Install (10 units) Application: SB-6335T4/SB-6335R4

SB-6335T4/SB-6335R4: Wall mount accessories

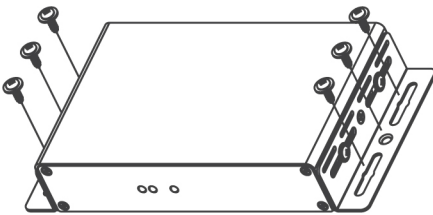

Model No.: #WM-1INCH-L80MM

SB-6335T4/SB-6335R4 Wall mount pairs

Parts No.: MEER6320ER11000

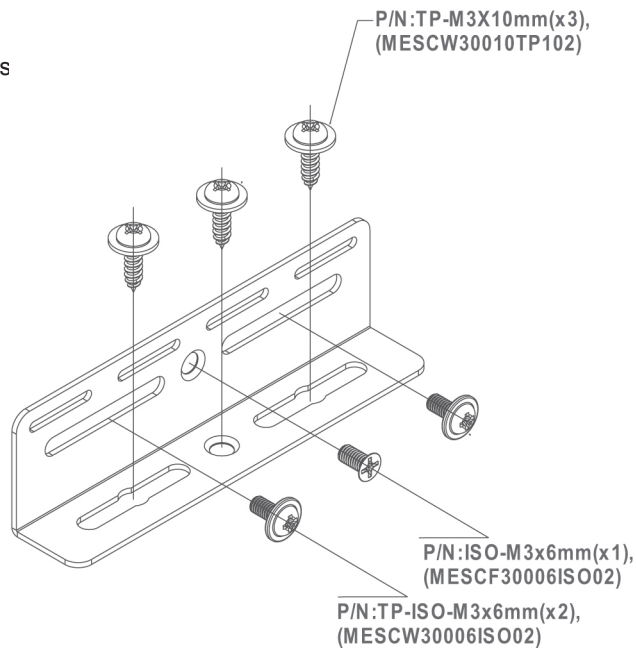
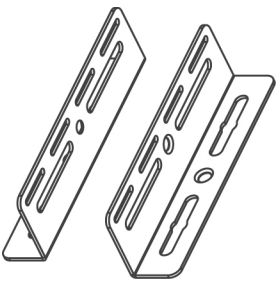

THIS PAGE IS INTENTIONALLY LEFT BLANK.

LIMITED WARRANTY

PLEASE READ THE FOLLOWING TERMS AND CONDITIONS CAREFULLY BEFORE USING THIS HARDWARE, COMPONENTS AND SOFTWARE PROVIDED BY, THROUGH OR UNDER SHINYBOWUSA, INC (COLLECTIVELY, THE "PRODUCT"). By using installing or using the Product, you unconditionally signify your agreement to these Terms and Conditions. If you do not agree to these Terms and Conditions, do not use the Product and return the Product to SHINYBOWUSA, Inc. at the return address set forth on the Product's packing label at your expense. SHINYBOWUSA, Inc. may modify these Terms and Conditions at anytime, without notice to you.

RESTRICTIONS ON USE OF THE PRODUCT

It is your responsibility to read and understand the installation and operation instructions, both verbal and in writing, provided to you with respect to the Product. You are authorized to use the Product solely in connection with such instructions. Any use of the Product not in accordance with such instructions shall void any warranty pertaining to the Product. Any and all damages that may occur in the use of the Product that is not strictly in accordance with such instructions shall be borne by you and you agree to indemnify and hold harmless SHINYBOWUSA, Inc. from and against any such damage.

The Product is protected by certain intellectual property rights owned by or licensed to SHINYBOWUSA. Any intellectual property rights pertaining to the Product are licensed to you by SHINYBOWUSA, Inc. and/or its affiliates, including any manufacturers or distributors of the Product (collectively, "SHINYBOWUSA") for your personal use only, provided that you do not change or delete any proprietary notices that may be provided with respect to the Product.

The Product is sold to you and any use of any associated intellectual property is deemed to be licensed to you by SHINYBOWUSA for your personal use only. SHINYBOWUSA does not transfer either the title or the intellectual property rights to the Product and SHINYBOWUSA retains full and complete title to the intellectual property rights therein. All trademarks and logos are owned by SHINYBOWUSA or its licensors and providers of the Product, and you may not copy or use them in any manner without the prior written consent of SHINYBOWUSA, which consent may be withheld at the sole discretion of SHINYBOWUSA.

The functionality and usability of the Product is controlled by SHINYBOWUSA, Inc. from its offices within the State of Texas, United States of America. SHINYBOWUSA makes no representation that materials pertaining to the Product are appropriate or available for use in other locations other than the shipping address you provided with respect thereto. You are advised that the Product may be subject to U.S. export controls.

DISCLAIMERS AND LIMITATION OF LIABILITY

SHINYBOWUSA may change or modify the Product at any time, from time to time.

THE PRODUCT IS PROVIDED "AS IS" AND WITHOUT WARRANTIES OF ANY KIND EITHER EXPRESS OR IMPLIED. SHINYBOWUSA DOES NOT WARRANT OR MAKE ANY REPRESENTATIONS REGARDING THE USE OR THE RESULTS OF THE USE OF THE PRODUCT'S CORRECTNESS, ACCURACY, RELIABILITY, OR OTHERWISE.

SHINYBOWUSA has no duty or policy to update any information or statements pertaining to the Product and, therefore, such information or statements should not be relied upon as being current as of the date you use the Product. Moreover, any portion of the materials pertaining to the Product may include technical inaccuracies or typographical errors. Changes may be made from time to time without notice with respect to the Product.

TO THE FULLEST EXTENT PERMISSIBLE PURSUANT TO APPLICABLE LAW, SHINYBOWUSA DISCLAIMS ALL WARRANTIES, EXPRESS OR IMPLIED, INCLUDING, BUT NOT LIMITED TO IMPLIED WARRANTIES OF MERCHANTABILITY, FITNESS FOR A PARTICULAR PURPOSE AND NON-INFRINGEMENT. SHINYBOWUSA DOES NOT WARRANT THE ACCURACY, COMPLETENESS OR USEFULNESS OF ANY INFORMATION WITH RESPECT TO THE PRODUCT. SHINYBOWUSA DOES NOT WARRANT THAT THE FUNCTIONS PERTAINING TO THE PRODUCT WILL BE ERROR-FREE, THAT DEFECTS WITH RESPECT TO THE PRODUCT WILL BE CORRECTED, OR THAT THE MATERIALS PERTAINING THERETO ARE FREE OF DEFECTS OR OTHER HARMFUL COMPONENTS. SHINYBOWUSA WILL USE ITS REASONABLE EFFORTS TO CORRECT ANY DEFECTS IN THE PRODUCT UPON TIMELY WRITTEN NOTICE FROM YOU NOT TO EXCEED 10 BUSINESS DAYS AFTER RECEIPT BY YOU OF THE PRODUCT, BUT YOU (AND NOT SHINYBOWUSA) ASSUME THE ENTIRE COST OF ALL NECESSARY SERVICING, REPAIR AND CORRECTION THAT WAS CAUSED BY YOU UNLESS OTHERWISE AGREED TO IN A SEPARATE WRITING BY SHINYBOWUSA.

UNDER NO CIRCUMSTANCES, INCLUDING, BUT NOT LIMITED TO, NEGLIGENCE, SHALL SHINYBOWUSA BE LIABLE FOR ANY SPECIAL OR CONSEQUENTIAL DAMAGES THAT RESULT FROM THE USE OF, OR THE INABILITY TO USE THE PRODUCT IN ACCORDANCE WITH ITS SPECIFICATIONS, EVEN IF SHINYBOWUSA OR ITS REPRESENTATIVES HAVE BEEN ADVISED OF THE POSSIBILITY OF SUCH DAMAGES. IN NO EVENT SHALL SHINYBOWUSA'S TOTAL LIABILITY TO YOU FROM ALL DAMAGES, LOSSES, AND CAUSES OF ACTION (WHETHER IN CONTRACT, OR OTHERWISE) EXCEED THE AMOUNT YOU PAID TO SHINYBOWUSA, IF ANY, FOR THE PRODUCT.

END OF DOCUMENT

122 Rose Ln. Suite 303 | Frisco, Texas 75034

1-877-SHINY-USA

1-877-744-6987

1-972-377-2508

sales@shinybowusa.com

www.shinybowusa.com

SHINYBOW™ USA
MULTIMEDIA AUDIO AND VISUAL