

# SB-5688CAP

8x HDMI Inputs / 8x HDMI & 8x HDBaseT™ PoH Outputs  
UHD 4K2K Matrix Routing Switch w/ EDID Management/Learning  
w/ Auxiliary Audio I/O



### IMPORTANT WARRANTY INFORMATION.

*If you remove the HDMI screw posts, you must use the provided HDMI Locking Post replacement screws to keep the internal HDMI jack secure. Removing the HDMI screws without installing the HDMI Locking Post replacement screws will void your warranty.*



## SAFETY INFORMATION



1. To ensure the best results from this product, please read this manual and all other documentation before operating your equipment. Retain all documentation for future reference.
2. Follow all instructions printed on unit chassis for proper operation.
3. To reduce the risk of fire, do not spill water or other liquids into or on the unit, or operate the unit while standing in liquid.
4. Make sure power outlets conform to the power requirements listed on the back of the unit. Keep unit protected from rain, water and excessive moisture.
5. Do not attempt to clean the unit with chemical solvents or aerosol cleaners, as this may damage the unit. Dust with a clean dry cloth.
6. Do not use the unit if the electrical power cord is frayed or broken. The power supply cords should be routed so that they are not likely to be walked on or pinched by items placed upon or against them, paying particular attention to cords and plugs, convenience receptacles, and the point where they exit from the appliance.
7. Do not force switched or external connections in any way. They should all connect easily, without needing to be forced.
8. Always operate the unit with the AC ground wire connected to the electrical system ground. Precautions should be taken so that the means of grounding of a piece of equipment is not defeated.
9. AC voltage must be correct and the same as that printed on the rear of the unit. Damage caused by connection to improper AC voltage is not covered by any warranty.
10. Turn power off and disconnect unit from AC current before making connections.
11. Never hold a power switch in the "ON" position.
12. This unit should be installed in a cool dry place, away from sources of excessive heat, vibration, dust, moisture and cold. Do not use the unit near stoves, heat registers, radiators, or other heat producing devices.
13. Do not block fan intake or exhaust ports. Do not operate equipment on a surface or in an environment which may impede the normal flow of air around the unit, such as a bed, rug, carpet, or completely enclosed rack. If the unit is used in an extremely dusty or smoky environment, the unit should be periodically "blown free" of foreign dust and matter.
14. To reduce the risk of electric shock, do not remove the cover. There are no user serviceable parts inside. Refer all servicing to qualified service personnel. There are no user serviceable parts inside.
15. When moving the unit, disconnect input ports first, then remove the power cable; finally, disconnect the interconnecting cables to other devices.
16. Do not drive the inputs with a signal level greater than that required to drive equipment to full output.
17. The equipment power cord should be unplugged from the outlet when left unused for a long period of time.
18. Save the carton and packing material even if the equipment has arrived in good condition. Should you ever need to ship the unit, use only the original factory packing.
19. Service Information Equipment should be serviced by qualified service personnel when:
  - A. The power supply cord or the plug has been damaged.
  - B. Objects have fallen, or liquid has been spilled into the equipment.
  - C. The equipment has been exposed to rain.
  - D. The equipment does not appear to operate normally, or exhibits a marked change in performance.
  - E. The equipment has been dropped, or the enclosure damaged.

# TABLE OF CONTENTS

## HDMI-HDBaseT™ AUDIO MATRIX SWITCHER SERIES

Thank you for purchasing the SB-5688CAP HDMI-HDBaseT™ Matrix Switcher with PoH (Power Over HDBaseT™). You will find this unit easy to install and highly reliable but it is essential that you read this manual thoroughly before attempting to use 8x8 HDMI-HDBaseT™ Matrix switcher.

### CONTENTS

PACKAGE CONTENTS .....	1
INTRODUCTION .....	2
FEATURES .....	2
SPECIFICATIONS .....	3
FRONT PANEL .....	4
BACK PANEL .....	10
REMOTE CONTROL .....	14
REMOTE PROTOCOL COMMANDS .....	15
EDID FUNCTIONS .....	17
TYPICAL APPLICATION .....	22
IR EXTENDER .....	25
RS-232 / ETHERNET SERIAL INTERFACE .....	27

### PACKAGE CONTENTS

Check that you have the following components:

- SB-5688CAP Matrix Switcher
- RS-232 V2.0 / Ethernet V2.0 Protocol Instructions
- IR Remote Control (SW-5688CAP)
- (8) Individual IR Remote Controls (SW-5688CAP-IR01~IR08)
- 19 inch ear mount bracket (Part # 2U-440L)
- SB-100 IR Extender Receiver Set
- SB-101 IR Extender Transmitter Set
- CD Contents: Manual, Windows GUI, ISP V1.0 Windows driver
- RS-232 Cable 6 feet (2M)
- HDMI Locking Post Replacement Screws
- Users Guide
- Worldwide Universal Power Supply 100~240VAC, AC 50/60Hz
- *Optional: SB-100C IR Extender Receiver Cable (6.5ft (2M))*
- *Optional: SB-101C IR Extender Transmitter Cable (6.5ft (2M))*



-- SB-6320T HDBaseT™ Transmitters & SB-6320R HDBaseT™ Receiver sold separately --

## LOOK A PUPPY!! NOW READ THIS!!



### IMPORTANT WARRANTY INFORMATION.

**If you remove the HDMI screw posts, you must use the provided HDMI Locking Post replacement screws to keep the internal HDMI jack secure. Removing the HDMI screws without installing the HDMI Locking Post replacement screws will void your warranty.**

### SAFETY PRECAUTIONS

Please read all instructions before attempting to unpack, install or operate this equipment and before connecting the power supply. Please keep the following in mind as you unpack and install this equipment:

- Always follow basic safety precautions to reduce the risk of fire, electrical shock and injury to persons.
- To prevent fire or shock hazard, do not expose the unit to rain, moisture or install this product near water.
- Never spill liquid of any kind on or into this product.
- Never push an object of any kind into this product through any openings or empty slots in the unit, as you may damage parts inside the unit.
- Do not attach the power supply cabling to building surfaces.
- Use only the supplied power supply unit (PSU). Do not use the PSU if it is damaged.
- Do not allow anything to rest on the power cabling or allow any weight to be placed upon it or any person walk on it.
- To protect the unit from overheating, do not block any vents or openings in the unit housing that provide ventilation and allow for sufficient space for air to circulate around the unit.

### DISCLAIMERS

The information in this manual has been carefully checked and is believed to be accurate. We assume no responsibility for any infringements of patents or other rights of third parties which may result from its use.

We assume no responsibility for any inaccuracies that may be contained in this document. We make no commitment to update or to keep current the information contained in this document.

We reserve the right to make improvements to this document and/or product at any time and without notice.

### COPYRIGHT NOTICE

No part of this document may be reproduced, transmitted, transcribed, stored in a retrieval system, or any of its part translated into any language or computer file, in any form or by any means — electronic, mechanical, magnetic, optical, chemical, manual, or otherwise — without express written permission and consent. © Copyright 2016. All Rights Reserved.

Version 2.5 JULY 2016  
5688CAP-20140721-001  
ENCL005688CAPA0



### TRADEMARK ACKNOWLEDGMENTS

All products or service names mentioned in this document may be trademarks of the companies with which they are associated.



# INTRODUCTION & FEATURES

## INTRODUCTION

---

The SB-5688CAP is a professional 8x8 matrix routing switch with PoH (Power Over HDBaseT™). Supporting (8) HDMI and (8) Auxiliary Audio Inputs and (8) HDMI, (8) SPDIF and (8) HDBaseT™ (PoH) Outputs. The SB-5688CAP is based on the HDBaseT™ standards and supports full HDMI video resolution with embedded EDID and PoH function, Audio, RS-232, Ethernet and bi-directional IR, all over a single category cable. With a signal bandwidth of 340Mhz, so there is no signal degradation. High Definition Digital signals can be selected and distributed to any (8) inputs to the (16) outputs simultaneously (channel outputs mirrored). The switcher is certified as being fully CEC, ARC and HDCP 2.0 compliant, full HD 4K2K HDMI V1.4a 3D formats, with data rates up to 6.75Gbps. Using the build-in booster, each HDMI output port is capable of driving cable lengths for 1080p up to 98 ft (30M) & 4K2K up to 66 ft (20M). Supports UXGA/WUXGA/DVI 1920x1200 resolutions to any HD display. The SB-5688CAP has (1) HDMI and Auxiliary Audio (analog stereo audio) connector per input, effectively making this an (8) In by (16) Out switcher (same signal on both outputs). Using the IR remote, the switcher's HDBaseT™ Extender Transmitter (Tx) allows you to connect a source in a remote location. Likewise, the HDBaseT™ output and our HDBaseT™ Receiver allows you to connect a display in a remote location. The EDID management can be selected between (7) different modes. Control is provided via front panel push buttons, IR remote, RS-232 or TCP/IP (not a web-browser). A RS-232 Windows GUI interface is provided for matrix routing control (Windows only).

## FEATURES

---

Based on HDBaseT™; bi-directional IR, RS-232, Multi format Audio, Ethernet and PoH. Full resolution HD Video, all HDBaseT™ signals over one CATx cable.

- (8) HDMI with Auxiliary Audio (Analog Audio) player devices matrix switched to (8) HDMI with S/PDIF outputs and (8) HDBaseT™ Transmitter with PoH outputs to (8) destinations
- HDBaseT™ specifications with PoH 48VDC, IR, RS-232, Multi Audio format and HD
- Video signals over one CAT6/6a/7 category cable
- HDMI digital video w/ embedded HDCP, DVI format and CEC/HDCP 2.0 compliant
- Worldwide control EDID modes for HDMI full 4K2K (24/30Hz) HD video resolutions
- Link speeds of up to 6.75Gbps (link clock rate of 340MHz), Supports HDMI 4K2K, 1.4a 3D formats
- Wide range of HD resolutions from PC XGA to WUXGA 1920x1200 and HDTV/DTV HDMI resolutions 480i/480p, 576i/576p, 720p, 1080i/p & 4K2K (24/30Hz)
- Compatible with all HDMI source devices, PC monitors, Plasma HD displays, HDTV and audio receivers or audio amplifiers
- Digital Video TMDS formats, Resolutions up to 4K2K with Deep color 36-bit
- Digital Audio Support: Dolby TrueHD, Dolby Digital, Dolby Digital Plug/ex, DTS, DTS-HD, DTS-HD Master, DTS-EX, PCM, PCM2, LPCM2
- Audio Input: Supports Auxiliary Audio (analog stereo audio)
- Audio Output: Supports Digital audio ARC or Digital audio S/PDIF (from HDMI source or Auxiliary Audio)
- Various User Interface controls:
  - Windows based GUI control via RS-232 port
  - Front panel push button
  - IR wireless remote control
  - Ethernet switch control
  - Third party RS-232 control (via simple ASCII)
- Supports (9) world wide control function keys:
  - Full function front panel controls: ARC / AUX/ ALL / OFF / EDID / LOCK / RECALL / MEMORY / ENTER
- Supports EDID Modes:
  - a. (7) Embedded EDID Modes: FSS/ H24-3D/ H24-3D-M/ H36-3D/ H36-3D-M/ 4K2K-3D / DVI-D 1920x1200-60Hz
  - b. External Modes: Learning mode-1 (Single Learning) & Learning mode-2 (Multiple Learning)
- Automatic scanning input & output status via LCM display on front panel
- Using the build-in booster, each HDMI output port is capable of driving cable lengths 1080p up to 98 ft (30M) & 4K2K up to 66 ft (20M)
- Supports IR Remote and IR Extender for distances up to ~ 984 ft (300M) Maximum
- Supports universal power adaptor AC100V~AC240V, 50/60Hz

The switcher will remember that last state during a power cycle. When power is removed and resorted, the last configuration will be invoked.



# SPECIFICATIONS

## SPECIFICATIONS

---

- **Type of HDMI Switcher:** (8) Inputs to (8) Outputs HDMI over HDBaseT™ Matrix Switch with Audio and Extension
- **HDMI Support:** HDMI 4K2K, 1080p@60Hz, H36-bit Deep color, 3D of HDMI V1.4 formats
- **HDBaseT™ Support:** Bi-directional IR, RS-232, Multi format Audio, Ethernet and PoH function, over one CATx cable
- **HDCP / CEC Support:** HDCP 2.2 Compliant, CEC Compliant
- **Video Bandwidth:** Double Data Rates: 340MHz, Total 6.75Gbps bandwidth
- **Digital Video Support:** HD: 480i/ 480p/ 720p/ 1080i/p and 4K2K up to 36bit deep color
- **Inputs:**
  - **Video Inputs HDMI:** (8) HDMI (HDMI or DVI digital source)
  - **Audio Inputs Audio:** (8) Audio (Analog Stereo, AUX port 3.5mm Jack)
- **Outputs:**
  - **Video Outputs**
    - **HDMI:** With booster output 1080p up to ~98 ft (35M) & 4K2K up to ~66 ft (20M)
    - **HDBaseT™:** (8) HDBaseT™ Transmitter (with PoH 48VDC via category cable & RJ-45 connector)
  - **Audio Outputs:**
    - **S/PDIF:** (8) S/PDIF: Multi Audio Formats 5.1 from HDMI or LPCM-2CH from Auxiliary audio
    - **ARC:** (8) ARC: TV Return Channel Audio
    - **HDMI:** (8) HDMI: Multi Audio Formats 5.1 / 7.1, MAT(MLP), Dolby Digital, Dolby TrueHD, Dolby Digital Plus, DTS, DTS-ES 6CH, DTS-HD, DTS-HD-HRA, DTS-HD Master, (PCM-2CH)
- **HDBaseT™ Control In:**
  - (8) IR In (Sends IR signals to (8) rooms via a HDBaseT™ Transmitter)
  - (1) ALL IR in (Sends IR signals to (8) rooms via a HDBaseT™ Transmitter)
- **HDBaseT™ Control Out:**
  - (8) IR Out (Links to the IR to receive signals from up to (8) rooms via a HDBaseT™ Extender)
  - (1) ALL IR Out (Links to the IR to receive signals from up to (8) rooms via a HDBaseT™ Extender)
  - (1) All Tx LAN (All switcher HDBaseT™ Transmitter Ethernet links to a HDBaseT™ Receiver)
- **HDBaseT™ Control I/O:**
  - (8) RS-232 I/O (Controls up to (8) rooms with RS-232 via the HDBaseT™ Extender Tx)
- **Switcher Controls:**
  - Select & Function buttons on front panel (Data status via LCM panel show out)
  - IR Remote Control (switch control)
  - (8) IR Room Remote Controls (switch control)
  - IR External port (switch control via 3.5mm OD Jack)
  - RS-232 series interface (switch control)
  - Ethernet series interface (switch control)
- **Source Status:** Input status LEDs indicates presence of a live signal
- **(25) Function Control Keys:** 1. ARC, 2. AUX, 3. ALL, 4. OFF, 5. RECALL, 6. ENTER, 7. MEMORY, 8. LOCK, 9. EDID, 10. Destination button 1 thru 8, 11. Source button 1 thru 8
- **(7) EDID Management Modes:**
  - **Select Embedded EDID Modes:** Mode1: FSS, Mode2: H24-3D, Mode3: H24-3D-M, Mode4: H36-3D, Mode5: H36-3D-M, Mode6: 4K2K-3D, PCM-2CH, Mode7: DVI-D 1920x1200
  - **Select LEARNING Mode:** Learning Destination EDID To Link Source. Learning mode-1 (Single Learning), Learning mode-2 (Multiple Learning)
- **Infrared Frequency:** 38Khz
- **IR Extend Distance:** ~984 ft / 300M maximum
- **HDBaseT™ Extender Distance:** ~328 ft / 100M maximum
- **HDMI I/O Connector:** HDMI Type A - SMD 19-pin female type
- **Temperature:** Operating Temperature 32°F-100°F (0°C-32°C)
- **Dimensions (LxWxH):** 17.5 x 12 x 3.5 in
- **Rack Mount:** 2RU High 19 in Rack Mount #2U-440L (with rack mount)
- **Power Supply:** AC 100~240VAC 50/60Hz (Power Consumption: ~3Amp)
- **Safety Approvals:** CE, FCC, RoHS, REACH
- **Weight:** 14.6 lb (Unit only) / 20.3 lb (Net)

As product improvements are continuous, specifications are subject to change without notice.

# FRONT PANEL

## FRONT PANEL

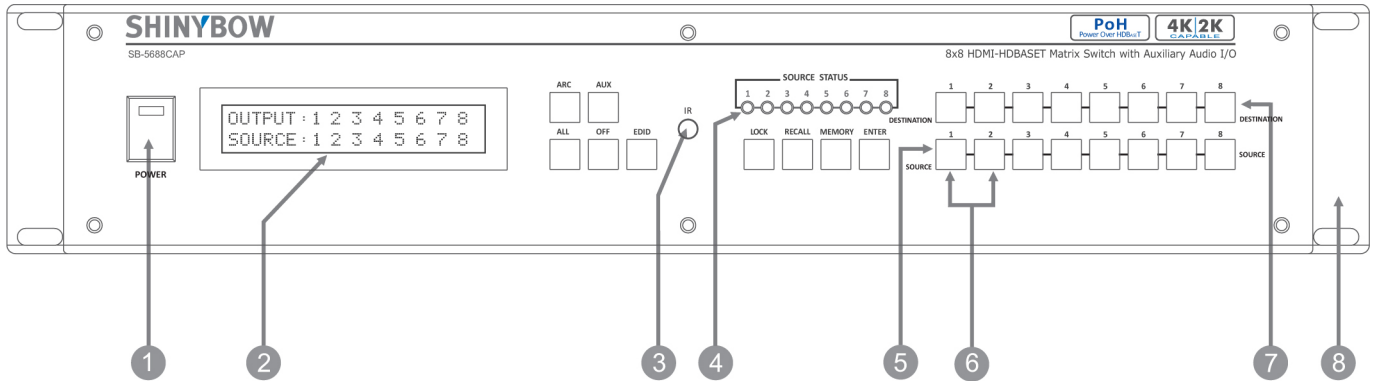

**1. POWER ON SWITCH:** The power switch turns the unit on and off. The LCM will illuminate blue to indicate the switcher is ON and receiving power. The switcher will remember the last setting during a power cycle. When power is removed and resorted, the last configuration will be evoked.

**2. STATUS DISPLAY:** Front panel status display shows current matrix routing configuration. This same display also shows particular configuration settings depending on your current function. In run mode (as shown above), the display shows each Output (destination) channel to which input (source) it is assigned.

**3. IR SENSOR:** The IR sensor receives IR commands from the supplied remote control or third party IR emitter.

**4. INPUT STATUS DISPLAY:** Input sources 1 to 8 LED illuminates blue to indicate that a video source is present on that input.

**5. SOURCE SELECT BUTTONS:** Separate inputs 1 thru 8 select buttons are provided each source selection.

**6. EDID MODE SELECT BUTTONS:** Used to select EDID mode using Source button #1 or #2.

**7. DESTINATION SELECT BUTTONS:** Separate outputs 1 thru 8 select buttons are provided for each destination assignment. Routing can be source to destination or one source to multiple destinations.

**Example:** Press Destination 1, 3, 5, then press Source 2. It will route Input 2 to Output 1, 3, 5 respectively.

**8. 19 INCH EAR MOUNT PAIR:** Converts desktop to 19 inch rack mount. Bracket (part # 2U-440L) INCLUDED. Image shows rack mount bracket attached.

# FRONT PANEL-ARC

## FRONT PANEL-ARC

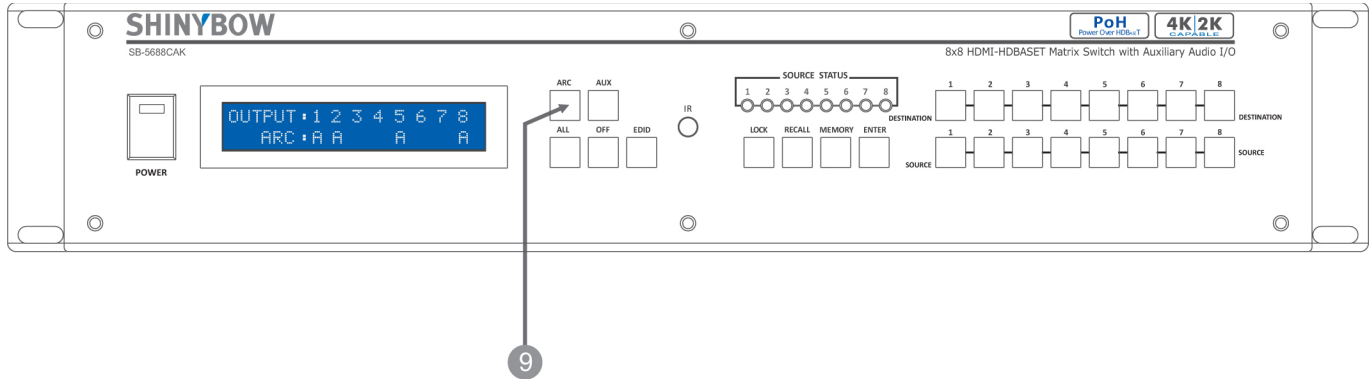

### 9. FUNCTION KEY - ARC:



Audio Return Channel (ARC) is a feature that sends audio from the TV back down the HDMI cable to its source device, in this case, the switcher. Not all displays support ARC, check your Users Guide for additional information. (Default = ARC Disabled)

The “Audio & ARC” port can support audio from either of (3) sources.

If the Input Video/Audio Source is HDMI, the audio can be extracted from the embedded signal.

If the Input Audio Source is connected to the external Audio Input, this same audio will be present on the Audio & ARC jack.

If ARC is selected, the audio will be from the destination device (**ex:** TV).

#### To enable the ARC option on a specific Output, perform the following steps:

- Press the **ARC** button.
- On the Destination row, Press **1 THRU 8** (the buttons will illuminate).
- Press the **ENTER** button. The new configuration will be stored.

The front panel LCD display will now show an “A” under the Output port.

- Or press **ARC** again to cancel the operation.

#### To disable the ARC option on a specific Output, perform the following steps:

- Press the **ARC** button
- On the Destination row, press **1 THRU 8** (the buttons will illuminate).
- Press **ENTER**. The pre-set configuration will execute.

The front panel LCD display will be blank under the Output port.

- Or press **ARC** again to cancel the operation.

#### Note:

1. Operation will abort if no keys are pressed within 5 seconds.

2. The AUX Audio input only functions when a valid HDMI / DVI video signal is present. Without video, the AUX audio will not operate.



# FRONT PANEL-AUX

## FRONT PANEL-AUX

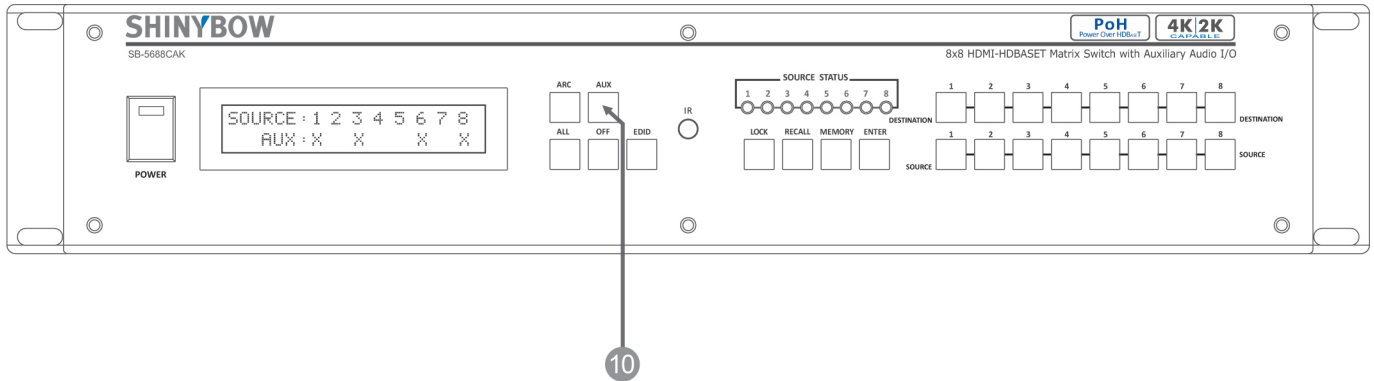

### 10. FUNCTION KEY - AUX (The audio additional on the “Audio / ARC” Port ):



The AUX FUNCTION feature allows you to replace the embedded HDMI audio signal with an audio signal that is connected to the switchers Audio AUX Input. Using the AUX function, this replaces the audio and does not mix the audio. (Default = AUX Disabled)

**To enable the AUX option on a specific Output, perform the following steps:**

- Press the **AUX** button.
- On the Source row, press **1 THRU 8** (the buttons will illuminate).
- Press **ENTER**. The new configuration will be stored.

The front panel LCD display will show an “X” under the Source port.

- Or press **AUX** again to cancel the operation.

**To disable the AUX option on a specific Output, perform the following steps:**

- Press the **AUX** button.
- On the Source row, press **1 THRU 8** (the buttons will illuminate).
- Press **ENTER**. The pre-set configuration will execute.

The front panel LCD display will be blank under the Output port indicating the audio source is not embedded on the HDMI cable.

- Or press **AUX** again to cancel the operation.

#### Note:

1. Operation will abort if no keys are pressed within 5 seconds.
2. The AUX Audio input only functions when a valid HDMI / DVI video signal is present. Without video, the AUX audio will not operate.

# FRONT PANEL-EDID

## FRONT PANEL-EDID

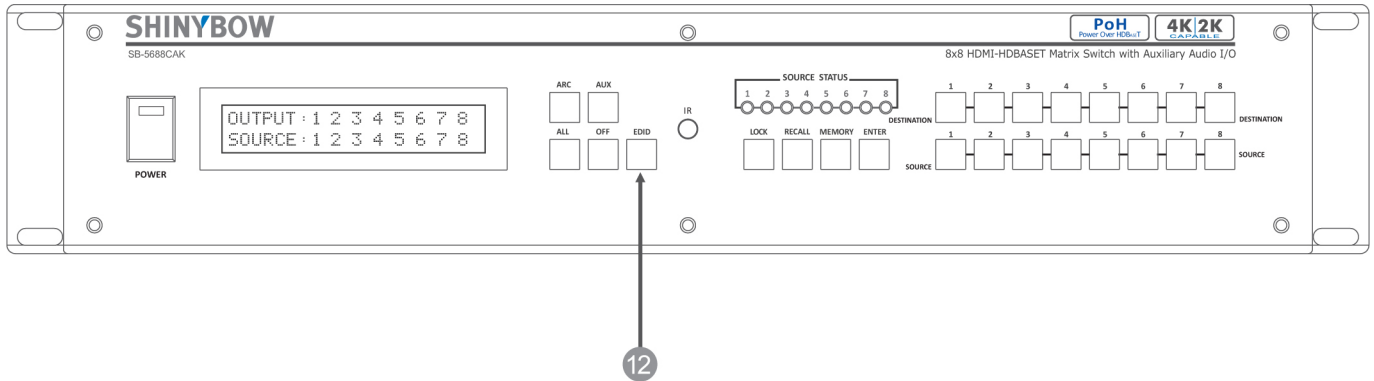

### 12. FUNCTION KEY - EDID (1):



Used to display/change current EDID mode.

- Press **EDID** to select new EDID mode or select.
- Press **SOURCE** row #1 or #2 to select EDID modes.
- Press **ENTER** to ready memory location.
- Or press **EDID** again to cancel the operation.

Operation completes.

**Note: Operation will abort if no keys are pressed within 5 seconds.**

### FUNCTION KEY - EDID (2):



Select external **LEARNING** mode

- Press **EDID** to select new EDID mode or selection.
- Press **Destination** again, press the same Destination #1 thru #8 to learn HDBaseT™ out port EDID. The EDID for HDBaseT™ (CATx) has been learned.
- Press **ENTER** to ready memory location.
- Or press **EDID** again to cancel the operation.

Operation completes.

**Note: Operation will abort if no keys are pressed within 5 seconds.**

# FRONT PANEL-ALL-OFF-LOCK-ENTER

## FRONT PANEL-ALL-OFF-LOCK-ENTER

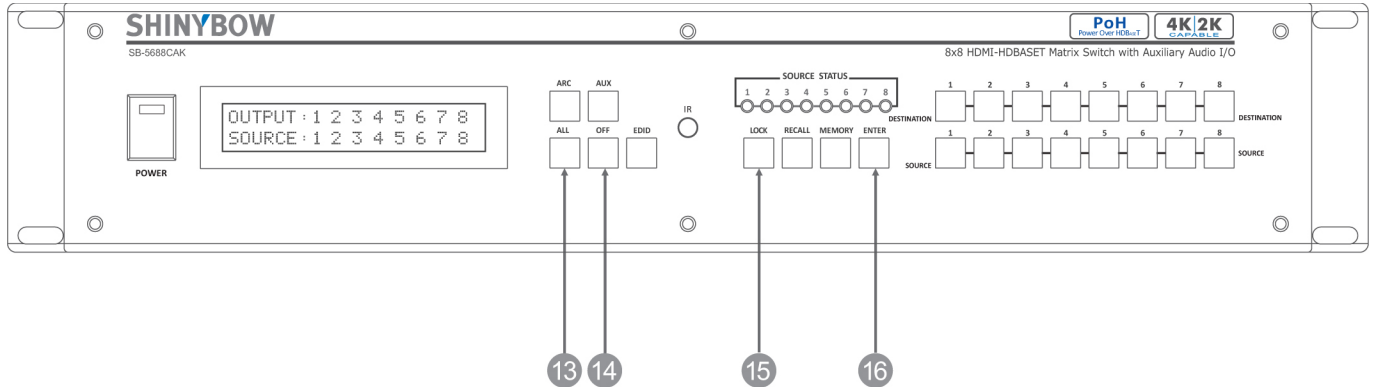

### 13. FUNCTION KEY - ALL:



Disables (mutes) video on all destinations OR assigns the same source to all destinations.

#### Option 1

- Press **ALL** followed by **OFF** button. The display will show "0" to indicate none of the destinations are assigned a video source.

#### Option 2

- Press **ALL** followed by Source **1 THRU 8**. The display will show the Source selected.  
- Press **ENTER**. The pre-set source selection will be assigned all destinations.

### 14. FUNCTION KEY - OFF:



Disables (mutes) video on the selected destinations.

- Press **OFF** button followed by any Destination channel.  
- Press **1 THRU 8** output destination. The display will show "0" for the selected channel, indicating no video selected.

### 15. FUNCTION KEY - LOCK:



- Press and hold **LOCK** button for two seconds lockout the front panel.  
- Press and hold **LOCK** button for two seconds to enable the front panel.

**16. FUNCTION KEY - ENTER:** Press **ENTER** to confirm entries.



# FRONT PANEL-RECALL-MEMORY

## FRONT PANEL-RECALL-MEMORY

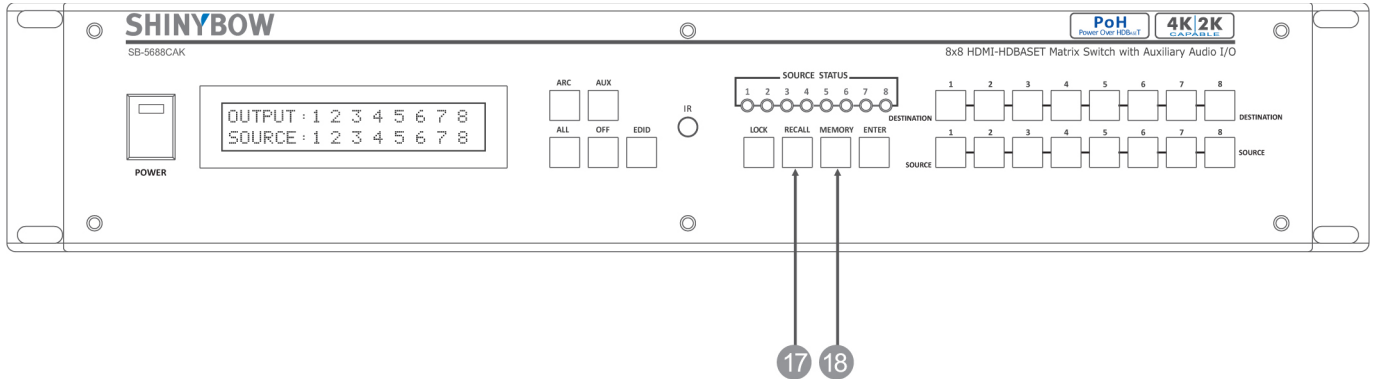

### 17. FUNCTION KEY - RECALL:



The system will show previously stored presets, up to a total of (16). Presets are stored in local memory using Source keys 1 thru 8 or Destination keys 1 thru 8 at the memory preset location.

- Press **RECALL** button.
- Press **1 THRU 8** on either Source or Destination row.
- Press **ENTER**. The pre-set configuration will execute.

Operation completes.

**Note: Operation will abort if no keys are pressed within 5 seconds.**

- Or press **RECALL** again to cancel the operation.

### 18. FUNCTION KEY - MEMORY:

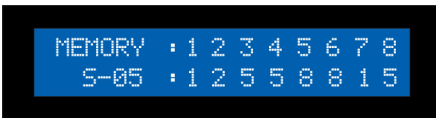

The system will show stored presets, up to a total of (16). Presets are stored in local memory using Source keys 1 thru 8 or Destination keys 1 thru 8 at the memory preset location.

- Configure desired matrices.
- Press **MEMORY** button.
- Press **1 THRU 8** on either Source or Destination row.
- Press **ENTER** to ready memory location.
- Or press **MEMORY** again to cancel the operation.

Operation completes.

**Note: Operation will abort if no keys are pressed within 5 seconds.**

- Or press **MEMORY** again to cancel the operation.

# BACK PANEL-SWITCH CONTROLS

## BACK PANEL-SWITCH CONTROLS

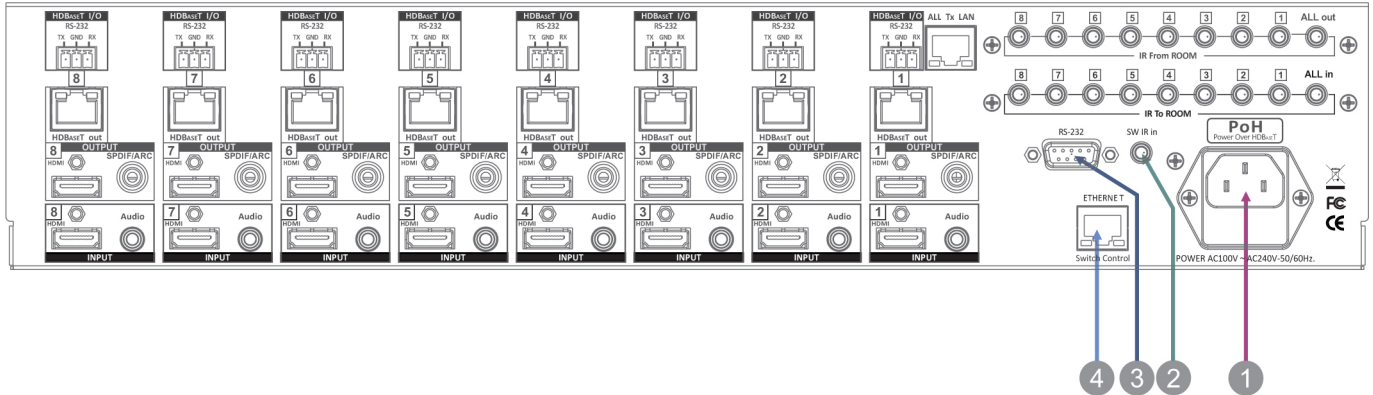

**1. DC POWER INLET:** The switcher is fitted with a AC power plug input connector. Be sure it is an approved type and is of sufficient current carrying connector capacity with the correct voltage and connector polarity. 100~240Volt AC, 50/60Hz power supply.



**POWER SOCKET:** Connector Type: IEC 60320 C13

**2. IR EXTENDER CONTROL:** Supports (1) IR Extender. Extends a maximum distance of up to ~984 ft/300M. When you plug the external IR extender into the switcher, the front panel IR receiver remains active.



**IR EXTENDER JACK:** Female jack - inner OD Ø 3.5mm

**3. RS-232 CONNECTION:** RS-232 control port allows for interfacing to a PC, such as a computer or touch panel control, to the switcher via the DB-9pin female connector for serial RS-232 control.

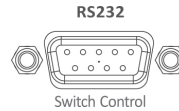

**REMOTE PORT:** D-SUB-9pin female connector

**4. ETHERNET CONNECTION:** ETHERNET control port allows for TCP/IP interfacing to a PC, such as a computer or touch panel control (not a web-browser), to the switcher via the RJ-45 female connector to control the switcher.

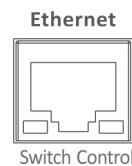

**REMOTE PORT:** Controls the switcher with a RJ-45 female connector

**ETHERNET PORT:** Note: *The Ethernet port and RS-232 port cannot be used simultaneously. Any connection to the Ethernet port will disable serial commands sent to the RS-232 port.*

# BACK PANEL-HDMI INPUT / OUTPUT

## BACK PANEL-HDMI INPUT / OUTPUT

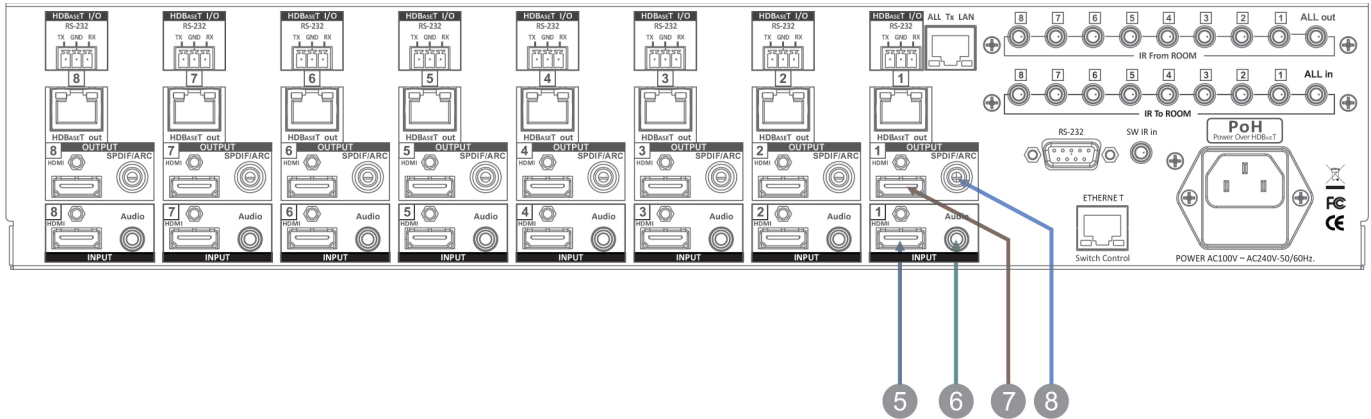

**5. INPUTS- 1,2,3,4,5,6,7, & 8 HDMI:** Connects a HDMI signal source direct to the HDMI digital video/audio female HDMI connector. This HDMI port supports HDMI and DVI digital video sources. If you remove the HDMI screw posts, you must use the provided HDMI Locking Post replacement screws to keep the internal HDMI jack secure. Removing the HDMI screws without installing the HDMI Locking Post replacement screws will void your warranty.

HDMI in

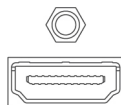

**HDMI CONNECTOR:** HDMI Type A SMD 19pin female socket connector

*Note: With the proper adapters, the switcher can be used with DVI digital video signals as it is HDCP compliant. DVI audio inputs are supported.*

**6. INPUTS- 1,2,3,4,5,6,7, & 8 AUDIO (Auxiliary Audio):** Connects an Auxiliary Audio signal direct to the Stereo Audio 3.5mm OD female jack. This jack supports DVI audio or Auxiliary Analog Stereo Audio sources. AUDIO Connector for Inputs 1 ~ 8.

Audio in



**AUDIO CONNECTOR:** OD Ø 3.5mm phone jack female socket connector

*Note: With the proper adapters, the switcher can be used with Auxiliary audio signals and DVI audio inputs are supported.*

**7. OUTPUTS- 1,2,3,4,5,6,7 & 8 HDMI:** Connects a HDMI signal source direct to the Output. This HDMI port supports HDMI with embedded audio and DVI with AUX audio. If you remove the HDMI screw posts, you must use the provided HDMI Locking Post replacement screws to keep the internal HDMI jack secure. Removing the HDMI screws without installing the HDMI Locking Post replacement screws will void your warranty.

HDMI out

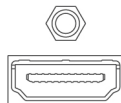

**HDMI CONNECTOR:** HDMI Type A SMD 19pin female socket connector

*Note: With the proper adapters, the switcher can be used with DVI digital video signals as it is HDCP compliant. DVI audio is supported.*

**8. OUTPUTS- 1,2,3,4,5,6,7 & 8 S/PDIF / ARC:** Connects a Auxiliary Audio output signal, HDMI digital audio source or ARC TV audio return channel direct to the RCA jack audio connector. This port use ARC digital audio (TV return digital audio) and S/PDIF digital audio from HDMI or Auxiliary Audio. Use RCA connector for Outputs 1 ~ 8.

SPDIF / ARC



**ARC & SPDIF AUDIO CONNECTOR:** RCA female connector

*Note: With the proper adapters, the audio can be used with HDMI audio, DVI audio and Auxiliary audio output signals. The Auxiliary audio uses digital LPCM-2CH outputs.*

### Audio Output Signals:

- ARC Audio (HDTV ARC Turn On)
- S/PDIF (HDMI/DVI Source Audio or Auxiliary Audio LPCM-2CH)



# BACK PANEL-HDBASET™ CONTROLS

## BACK PANEL-HDBASET™ CONTROLS

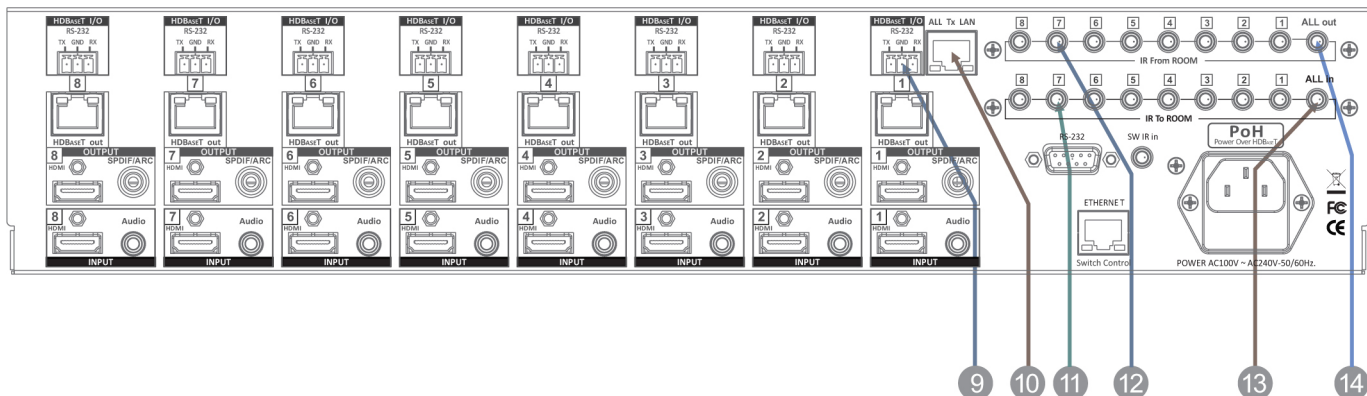

### 9. HDBaset™ RS-232: 1, 2, 3, 4, 5, 6, 7 & 8 CONNECTIONS:

(8) RS-232 control ports allow for interfacing to a PC. Controls I/O via HDBaset™ Transmitters from (8) rooms via the Terminal Block-3pin female socket for serial RS-232 control.



**REMOTE PORT:** Terminal Block-3pin female socket

### 10. HDBaset™ LAN CONNECTIONS:

**All Tx LAN:** Provides Ethernet (LAN) connection from the switcher to All HDBaset™ Transmitters (ie. SB-6320T).

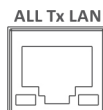

**ALL HDBASET™ TX LAN PORT CONNECTORS:** HDBaset™ Phone-Jack 8P8C, RJ-45 female socket

**LAN Controls:** *Note: From the switcher to the HDBaset™ Transmitter.*

### 11. HDBaset™ IR INPUTS: 1, 2, 3, 4, 5, 6, 7 & 8 REMOTE IR SIGNALS

**TO ROOM:** Sends (8) IR signals to (8) rooms via the HDBaset™ Transmitter. When you plug the HDBaset™ IR Transmitter into the external port, the room IR HDBaset™ receiver remains active.



**IR EXTENDER JACK:** Female jack - inner OD Ø 3.5mm

### 12. HDBaset™ IR OUTPUTS: 1, 2, 3, 4, 5, 6, 7 & 8 REMOTE IR SIGNAL FROM ROOM:

**FROM ROOM:** Receives (8) IR signals from (8) rooms via the HDBaset™ Transmitter. When you plug the HDBaset™ IR Transmitter into the external port, the room IR HDBaset™ receiver remains active.



**IR EXTENDER JACK:** Female jack - inner OD Ø 3.5mm

### 13. HDBaset™ ALL IN: 1, 2, 3, 4, 5, 6, 7 & 8 REMOTE IR SIGNAL TO ROOM:

**Sends IR signals to a room via the HDBaset™ Transmitter.** When you plug the HDBaset™ IR Transmitter into the external port, the room IR HDBaset™ receiver remains active.



**IR EXTENDER JACK:** Female jack - inner OD Ø 3.5mm

### 14. HDBaset™ ALL OUT: 1, 2, 3, 4, 5, 6, 7 & 8 REMOTE IR SIGNAL FROM ROOM:

**Receives IR signal from a room via the HDBaset™ Transmitter.** When you plug the HDBaset™ IR Transmitter into the external port, the room IR HDBaset™ receiver remains active.



**IR EXTENDER JACK:** Female jack - inner OD Ø 3.5mm

# BACK PANEL-HDBASET™ I/O

## BACK PANEL-HDBASET™ I/O

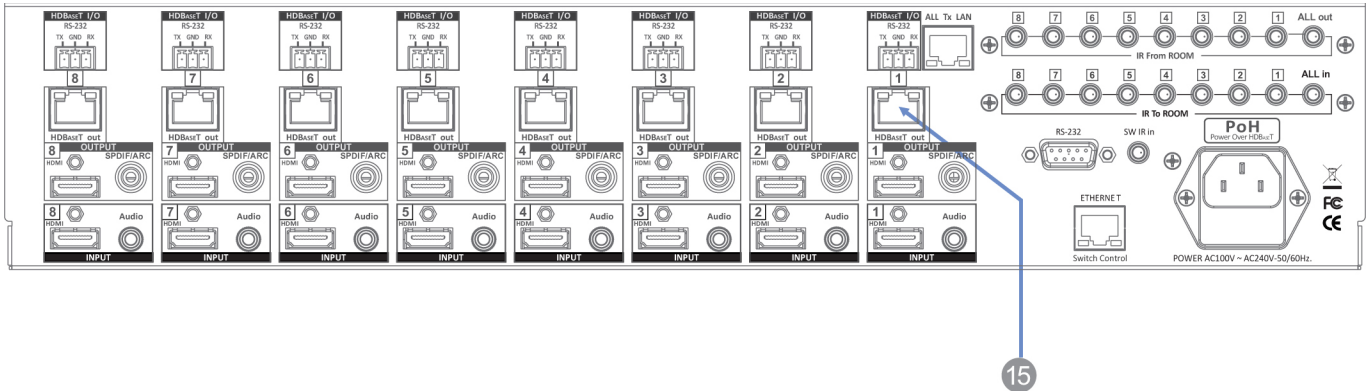

### 15. OUTPUT: 1, 2, 3, 4, 5, 6, 7 & 8 HDBaseT™ (Transmitter):

Sends (8) HDMI and control signals via the (8) HDBaseT™ Transmitters to link (8) external HDBaseT™ Receivers. The switcher uses (8) HDBaseT™ Transmitter Outputs 1 ~ 8 with PoH RJ-45 via CAT6/6a/7 category cable. Controls RS-232, ethernet, IR input, IR output and PoH signals between the switcher and the receiver.

### HDBASET™ TRANSMITTER CONNECTOR:

(8) RJ-45 Jack 8P8C female socket

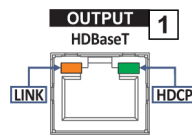

### Link LED :

- Solid = valid link
- Flash = attempting to link
- Off = no link established

### HDBaseT I/O Transmission :



Projector  
RS-232 & IR



SB-6320R  
HDBaseT Receiver

RX ← RS-232 & IR  
→ RS-232 & IR

### RS-232 Pin Define:

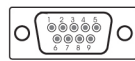

RS-232 Cable Pins out  
PC 232 PINS  
DB-9P, MALE plug

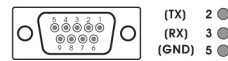

HDBaseT Receiver SB-6320R  
RS-232 PINS OUT  
DB-9P, FEMALE socket

### SB-5688CAK 8x8 HDMI-HDBaseT Matrix Switcher

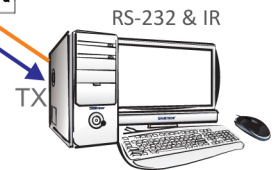
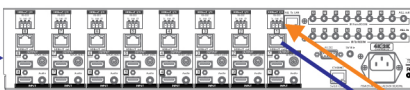

RS-232 & IR  
TX

### Category Cable Lengths from the Switcher to the HDBaseT™ Receiver

CABLE TYPE RESOLUTION	PIXEL CLOCK RATE (MHZ)	CAT5e (70M)	CAT6 (100M)	CAT6 (100M)
1024x768@60Hz	65.00 MHZ	Yes	Yes	Yes
1280x720p@60Hz	73.84 MHZ	Yes	Yes	Yes
1920x1080i@60Hz	74.25 MHZ	NA	NA	NA
1280x1024@60Hz	108.00 MHZ	Yes	Yes	Yes
1920x1080p@60Hz	148.50 MHZ	Yes	Yes	Yes
1920x1200@60Hz	152.90 MHZ	Yes	Yes	Yes
1600x1200@60Hz	162.00 MHZ	Yes	Yes	Yes
BD player: 1080p	174.00 MHZ	Yes	NA	Yes

# REMOTE CONTROL

## Before making any connections to the switcher, observe the following:

- Ensure the main voltage supply matches the label on the supplied plug-pack (+/-10%).
- Ensure that the power switch is OFF.
- Ensure that all system grounds (earth) are connected to a common point.
- Avoid powering equipment within a system from multiple power sources that may be separated by large distances.
- Connect all audio video sources and destination equipment.
- Power up all source and destination audio-visual sources.
- For each destination output select the appropriate input source by using the front panel input select buttons. The supplied IR remote control. Or through the RS-232 serial communications port.
- Upon powering up the switcher, it will return to its last used setting before being powered down.

## REMOTE CONTROL

### IR REMOTE CONTROL KEY :

**1. & 2. SWITCH POWER ON or OFF:** Power ON and OFF

### 3. DESTINATION: 1 thru 8 OUTPUT SELECTION:

Destination buttons to select the output display channel

### 4. SOURC : 1 thru 8 INPUT SOURCE SELECTION:

Input 1~8 source selection buttons

### 5. FUNCTION KEY:

 Function selection buttons

ARC	AUX	ALL
OFF	EDID	RECALL
MEMORY	ENTER	LOCK

### IR REMOTE : SW-HD88CAK

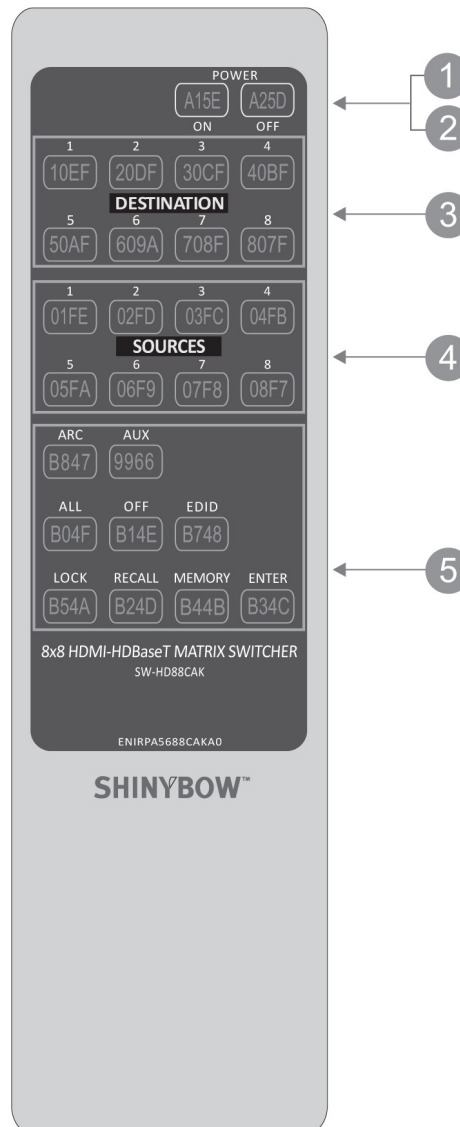

# REMOTE PROTOCOL COMMANDS

## IR REMOTE CUSTOM AND DATA CODES (NEC Standard)

---

### HOW TO SETUP IR CODES:

### CUSTOM CODE: 46B9

POWER ON:	46B9	A15E	LOCK:	46B9	B54A	EDID:	46B9	B748
POWER OFF:	46B9	A25D	RECALL:	46B9	B24D	ARC:	46B9	B847
ALL:	46B9	B04F	MEMORY:	46B9	B44B	AUX:	46B9	9966
OFF:	46B9	B14E	ENTER:	46B9	B34C			

### **PRESS DESTINATION - # then PRESS SOURCE - #**

DESTINATION #1 : 46B9	10EF	SOURCE #1 : 46B9	01FE
DESTINATION #2 : 46B9	20DF	SOURCE #2 : 46B9	02FD
DESTINATION #3 : 46B9	30CF	SOURCE #3 : 46B9	03FC
DESTINATION #4 : 46B9	40BF	SOURCE #4 : 46B9	04FB
DESTINATION #5 : 46B9	50AF	SOURCE #5 : 46B9	05FA
DESTINATION #6 : 46B9	609F	SOURCE #6 : 46B9	06F9
DESTINATION #7 : 46B9	708F	SOURCE #7 : 46B9	07F8
DESTINATION #8 : 46B9	807F	SOURCE #8 : 46B9	08F7

*For Example:*

### **Select Destination # 1 to show Source #1~8**

The IR Data Code list :

Destination # 1 , Source #1	46B9	10EF	46B9	01FE
Destination # 1 , Source #2	46B9	10EF	46B9	02FD
Destination # 1 , Source #3	46B9	10EF	46B9	03FC
Destination # 1 , Source #4	46B9	10EF	46B9	04FB
Destination # 1 , Source #5	46B9	10EF	46B9	05FA
Destination # 1 , Source #6	46B9	10EF	46B9	06F9
Destination # 1 , Source #7	46B9	10EF	46B9	07F8
Destination # 1 , Source #8	46B9	10EF	46B9	08F7



# ROOM REMOTE CONTROLS

## ROOM REMOTE CONTROL #1 ~ #8 CUSTOM CODE AND DATA CODES

### IR CUSTOM AND DATA CODES (NEC Standard)

PRESS Number To Select SOURCE  
CUSTOM CODE: 46B9

8x8 HDBT SWITCHER  
SW-HD88CAK-IR01



#### IR-01 DATA CODE:

SOURCE #1 : 46B9 11EE  
SOURCE #2 : 46B9 12ED  
SOURCE #3 : 46B9 13EC  
SOURCE #4 : 46B9 14EB  
SOURCE #5 : 46B9 15EA  
SOURCE #6 : 46B9 16E9  
SOURCE #7 : 46B9 17E8  
SOURCE #8 : 46B9 18E7

8x8 HDBT SWITCHER  
SW-HD88CAK-IR02



#### IR-02 DATA CODE:

SOURCE #1 : 46B9 21DE  
SOURCE #2 : 46B9 22DD  
SOURCE #3 : 46B9 23DC  
SOURCE #4 : 46B9 24DB  
SOURCE #5 : 46B9 25DA  
SOURCE #6 : 46B9 26D9  
SOURCE #7 : 46B9 27D8  
SOURCE #8 : 46B9 28D7

8x8 HDBT SWITCHER  
SW-HD88CAK-IR03

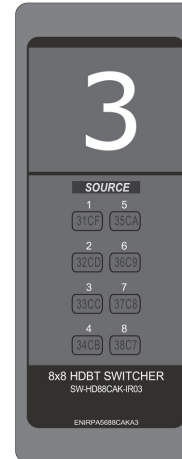

#### IR-03 DATA CODE:

SOURCE #1 : 46B9 31CE  
SOURCE #2 : 46B9 32CD  
SOURCE #3 : 46B9 33CC  
SOURCE #4 : 46B9 34CB  
SOURCE #5 : 46B9 35CA  
SOURCE #6 : 46B9 36C9  
SOURCE #7 : 46B9 37C8  
SOURCE #8 : 46B9 38C7

8x8 HDBT SWITCHER  
SW-HD88CAK-IR04

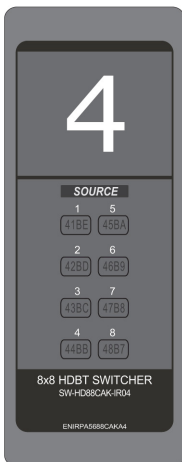

#### IR-04 DATA CODE:

SOURCE #1 : 46B9 46B9  
SOURCE #2 : 46B9 42BD  
SOURCE #3 : 46B9 43BC  
SOURCE #4 : 46B9 44BB  
SOURCE #5 : 46B9 45BA  
SOURCE #6 : 46B9 46B9  
SOURCE #7 : 46B9 47B8  
SOURCE #8 : 46B9 48B7

8x8 HDBT SWITCHER  
SW-HD88CAK-IR05



#### IR-05 DATA CODE:

SOURCE #1 : 46B9 51AE  
SOURCE #2 : 46B9 52AD  
SOURCE #3 : 46B9 53AC  
SOURCE #4 : 46B9 54AB  
SOURCE #5 : 46B9 55AA  
SOURCE #6 : 46B9 56A9  
SOURCE #7 : 46B9 57A8  
SOURCE #8 : 46B9 58A7

8x8 HDBT SWITCHER  
SW-HD88CAK-IR06

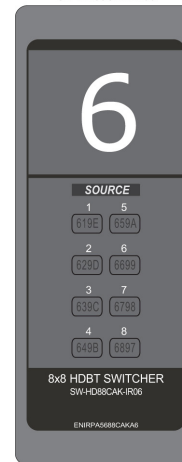

#### IR-06 DATA CODE:

SOURCE #1 : 46B9 61BE  
SOURCE #2 : 46B9 62BD  
SOURCE #3 : 46B9 63BC  
SOURCE #4 : 46B9 64BB  
SOURCE #5 : 46B9 65BA  
SOURCE #6 : 46B9 66B9  
SOURCE #7 : 46B9 67B8  
SOURCE #8 : 46B9 68B7

8x8 HDBT SWITCHER  
SW-HD88CAK-IR07

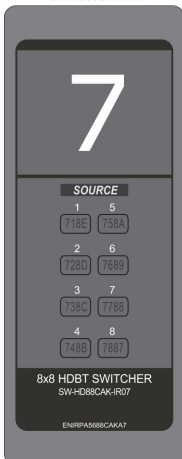

#### IR-07 DATA CODE:

SOURCE #1 : 46B9 71BE  
SOURCE #2 : 46B9 72BD  
SOURCE #3 : 46B9 73BC  
SOURCE #4 : 46B9 74BB  
SOURCE #5 : 46B9 75BA  
SOURCE #6 : 46B9 76B9  
SOURCE #7 : 46B9 77B8  
SOURCE #8 : 46B9 78B7

8x8 HDBT SWITCHER  
SW-HD88CAK-IR08





#### IR-08 DATA CODE:





SOURCE #1 : 46B9 817E  
SOURCE #2 : 46B9 827D  
SOURCE #3 : 46B9 837C  
SOURCE #4 : 46B9 847B  
SOURCE #5 : 46B9 857A  
SOURCE #6 : 46B9 8679  
SOURCE #7 : 46B9 8778  
SOURCE #8 : 46B9 8877

# EDID FUNCTION - SYSTEM RESET/FACTORY RESET

## SYSTEM RESET

SYSTEM RESET	RETURN SWITCH TO FACTORY DEFAULTS
<p>Press <b>RECALL &gt; OFF &gt; ENTER</b></p>   	<p><b>RESET to Factory Default</b></p> <ol style="list-style-type: none"> <li>1. Press <b>RECALL</b> button: The LCM will show the current stored presets status.</li> <li>2. Press <b>OFF</b> button: The LCM will show “<b>SYSTEM RESET</b>”</li> <li>3. Press <b>ENTER</b> button: To confirm entries. The switch will reset all customizable values back to factory defaults. You must <b>POWER CYCLE</b> the switch for the new values to take effect.</li> </ol>
<p><b>NOTE:</b> Factory Reset Defaults to:</p> <ol style="list-style-type: none"> <li>1. Source Destination will be set to 1-1, 2-2, 3-3, etc.</li> <li>2. Switch matrices stored in memory will be cleared.</li> <li>3. Lock function will return to Un-Locked.</li> <li>4. AUX function will disable and return to UN-AUX (On Select Models).</li> <li>5. ARC function will disable and return to SPDIF as the Output (On Select Models).</li> <li>6. EDID will return to FSS® (1080p-2ch Mode).</li> <li>7. Ethernet port will return to DHCP=ENABLED.</li> </ol>	

## RESET EDID



EDID RESET	PROCEDURE
<p><b>From the Front Panel:</b> Press <b>EDID &gt; RECALL &gt; OFF &gt; ENTER</b></p> 	<p><b>RESET EDID</b></p> <p>Press <b>EDID</b>.</p> <p>Press <b>RECALL</b>.</p> <p>Press <b>OFF</b>. The display should show Reset EDID.</p> <p>Press <b>ENTER</b>.</p>
<p><b>LEARNING MODE 2</b></p> <p>Press <b>EDID &gt; OFF &gt; DESTINATIONS &gt; ENTER</b></p> <p>The EDID for HDMI has been passed from the Destination port to the Source port.</p>    	<p><b>SETTING EDID TO LEARNING MODE 2</b></p> <ol style="list-style-type: none"> <li>1. Press <b>EDID</b> button: The LCM will show the current EDID status.</li> <li>2. Press <b>OFF</b> button: Does the OFF button stay illuminated? <ul style="list-style-type: none"> <li><b>*If Yes:</b> Press ALL the Destination buttons individually so they illuminate blue. The switcher will <b>LEARN</b> the destination HDMI EDID and pass to the selected source. The switcher will Enable or Disable HDMI EDID for the selected source.</li> </ul> </li> <li>3. Press <b>ENTER</b> to confirm changes. The LCM will return to the default screen showing selected matrix routing status. This puts you in Learning Mode 2. <ul style="list-style-type: none"> <li><b>*If No:</b> You might need a f/w update.</li> </ul> </li> </ol>

# EDID FUNCTION







## EDID FUNCTION FOR HDMI MATRIX SWITCHER

EDID SETUP	To Change The EDID Setup
<b>Step 1.</b> Press the <b>EDID</b> button	The display will show the currently selected EDID mode.
<b>Step 2.</b> Press <b>SOURCE #1 OR #2</b> button row	The button will flash blue and the display will show the current <b>Embedded EDID</b> Status.
<b>Step 3.</b> Press the <b>ENTER</b> button	To set EDID mode. The switcher will return to operation mode.
Operation will abort if no keys are pressed within 5 seconds.	
EMBEDDED EDID MODES	Total 7 EDID Modes
<b>Embedded EDID Setup</b> Press <b>EDID &gt; SOURCE &gt; ENTER</b> SOURCE #1 or SOURCE #2 	To select Embedded EDID mode or LEARNING mode. Repeatedly pressing the <b>SOURCE 1</b> button will cycle up thru the options. Repeatedly pressing the <b>SOURCE 2</b> button will cycle down thru the options.  <b>Embedded EDID:</b> Mode 1 : FSS® Mode 2 : H24-3D Mode 3 : H24-3D-M Mode 4 : H36-3D Mode 5 : H36-3D-M Mode 6 : 4K2K Mode 7 : DVI-D 1920x1200-60Hz

## EDID FUNCTION FOR HDMI MATRIX SWITCHER



RESET	EDID Return To Factory Default
<b>How to RESET EDID mode</b> Press <b>EDID &gt; RECALL &gt; ENTER</b>   	To RESET to FACTORY DEFAULT (1080p-2CH). Press <b>EDID</b> button: The LCM will show the current EDID status. Press <b>RECALL</b> button: The LCM will show the <b>RESET EDID</b> . Press <b>ENTER</b> to confirm entries. The EDID will return to FSS® mode and resolution 1080p-2CH.
EDID STATUS	To View The Current EDID Status
<b>Step 1.</b> Press <b>EDID</b> button	The button will flash blue and the display will show the current Embedded EDID Status.
<b>Step 2.</b> Press <b>EDID</b> button	To exit.
HOW TO SETUP FSS® FUNCTION	Fast Speed Start®
<b>Step 1.</b> Press the <b>DESTINATION #1~8</b> button row Then Press the <b>SOURCE #1~8</b> button row	To setup and Install all devices.
<b>Step 2.</b> Press <b>EDID</b> button	Select a optimum status of Embedded EDID mode.
<b>Step 3.</b> Press <b>ENTER</b> button	To confirm entries.
<b>Step 4.</b> Press <b>EDID</b> button	To select the EDID FSS® mode.
<b>Step 5.</b> Press <b>ENTER</b> button	To confirm entries.

# EDID FUNCTION

EDID function for HDMI Matrix Switcher	
<b>Mode 1. FSS® (Fast Speed Start®)</b> 	<b>Fast Speed Start®</b> mode shortens the startup time of the switcher. Selecting this mode does not force the EDID setup to be cancelled. Users may first select one EDID mode from mode 2 to 3, and then select mode 1 for fast speed start®.
<b>Mode 2. H24-3D (1080p-24 bits)</b> 	Audio Support: PCM 2CH
<b>Mode 3. H24-3D-M (1080p-24 bits)</b> 	Audio Support: MAT(MLP) 7.1CH, PCM-2CH, One Bit Audio 2CH, AC-3 5.1CH, DTS 5.1CH, PCM 7.1CH, Dolby Digital + 7.1CH, DTS-HD 7.1CH
<b>Mode 4. H36-3D (1080p-36 bits)</b> 	Audio Support: PCM 2CH
<b>Mode 5. H36-3D-M (1080p-36 bits)</b> 	Audio Support: MAT(MLP) 7.1CH, PCM 2CH, One Bit Audio 2CH, AC-3 5.1CH, DTS 5.1CH, PCM 7.1CH, Dolby Digital + 7.1CH, DTS-HD 7.1CH
<b>Mode 6. 4K2K (24/30Hz)</b> 	HDMI Support: 4K2K-3D, PCM 2CH (3860x2160-24/30Hz)  Audio Support: PCM 2CH
<b>Mode 7. 1920x1200-60Hz (DVI-D)</b> 	DVI Support: DVI-D 1920x1200 60Hz



# EDID FUNCTION

LEARNING EDID SINGLE TO SINGLE	Learning Destination #2 EDID To Source #3
<b>Step 1.</b> Press <b>EDID</b> button	The button will flash blue and the display will show the current <b>Embedded EDID</b> Status.
<b>Step 2.</b> Press the <b>DESTINATION #2</b> button row	Copy the Destination #2 Display EDID.
<b>Step 3.</b> Press the <b>SOURCE #3</b> button row	Learning the Destination #2 EDID To Source # 3.
<b>Step 4.</b> Press <b>ENTER</b> button	To confirm entries.
LEARNING EDID SINGLE TO MULTIPLE	Learning Destination EDID Link To The Majority Sources
<b>Step 1.</b> Press <b>EDID</b> button	The button will flash blue and the display will show the current Embedded EDID Status.
<b>Step 2.</b> Press the <b>DESTINATION 1-8</b> button row	Copy any 1~8 Destinations EDID.
<b>Step 3.</b> Press the <b>SOURCE 1-8</b> button row	Learning the Destination EDID link to source #1-8.
<b>Step 4.</b> Press <b>ENTER</b> button	To confirm entries.
LEARNING EDID SINGLE TO ALL	Learning Destination EDID Link To All Sources
<b>Step 1.</b> Press <b>EDID</b> button	The button will flash blue and the display will show the current Embedded EDID Status.
<b>Step 2.</b> Press destination button <b>1THRU 8</b>	Learning anyone 1~8 Destination EDID to all sources.
<b>Step 3.</b> Press <b>ALL</b> button	Learning selected destination EDID to all sources.
<b>Step 4.</b> Press <b>ENTER</b> button	To confirm entries.
SINGLE LEARNING #1 DEFINITION	Single Learning EDID From Destination To Source
<p>1. Switcher will LEARN destination EDID and pass the selected source.</p> <p>2. Learning EDID setup for HDBaseT™ CATx Key Press Sequence: <b>EDID &gt; DESTINATION # &gt; DESTINATION # &gt; SOURCE # &gt; ENTER</b>. Again, Press the same <b>DESTINATION #</b> to learn HDBaseT™ CATx EDID. The EDID for HDBaseT™ CATx has been learned</p> <p>3. To set up learning between a single destination and multiple sources: Press: <b>EDID</b> button &gt; <b>DESTINATION 1 THRU 8</b> &gt; Press the majority <b>SOURCES 1 THRU 8</b> &gt; Press <b>ENTER</b>. Switcher will learn single destination EDID to many source devices.</p> <p>4. How to Learning single destinations with all sources. Press <b>EDID</b> button &gt; Press <b>ALL</b> button &gt; Press <b>ENTER</b> to confirm.</p>	
MULTIPLE LEARNING #2 DEFINITION	Multiple Learning EDID From Destination To Source
<p>1. Switcher will multiple LEARN destination EDID and pass the selected source.</p> <p>2. To set up multiple learning between a single destination and single source: Press <b>EDID</b> button &gt; Press <b>OFF</b> button &gt; Press <b>DESTINATION 1 THRU 8</b> &gt; Press <b>ENTER</b> to confirm. Switcher will learn destination EDID to source device.</p> <p>3. When the Source has “Learned” the EDID data from a destination, it will save that EDID information into EPROM and the EDID data will not change. To change a saved HDMI EDID information, you have to select a new LEARNING destination to source or Disable the LEARNING.</p>	
LEARNING EDID	Learning EDID from Destination to Source
	<p>Press <b>EDID &gt; DESTINATION</b> Button: The LCM will be show LEARNING.</p> <p>Switcher will <b>LEARN</b> destination HDMI EDID and pass the selected source.</p> <p><b>Learning EDID setup for HDMI:</b> Key Sequence: <b>EDID &gt; DESTINATION # &gt; SOURCE # &gt; ENTER</b> The EDID for HDMI has been learned.</p>
	<p>Switcher will <b>LEARN</b> destination HDBaseT™ CATx EDID and pass the selected source.</p> <p><b>Learning EDID setup for HDBaseT™ CATx:</b> Key Sequence: <b>EDID &gt; DESTINATION # &gt; DESTINATION # &gt; SOURCE # &gt; ENTER</b> Again, Press the same DESTINATION # to learn HDBaseT™ CATx EDID The EDID for HDBaseT™ CATx has been learned.</p>





**NOTE: The already learned EDID cannot be modified. You can only rebuild a new Learning EDID.**

**For Example:** When the Source has “Learned” the EDID data from a destination, It will save that EDID information into EPROM and the EDID data cannot change. Please select new learning destination to sources or change to one of the embedded EDID modes when you want to remove the learning EDID memory from EPROM.

# EDID FUNCTION

## EDID MULTIPLE LEARNING MODE-2

The MULTIPLE LEARNING MODE-2 feature is part of a firmware update released after JUNE 2014. If you do not see the MULTIPLE LEARNING MODE-2 feature then you do not have the latest firmware. You should contact your place of purchase for availability of a firmware update. Not all devices are capable of a firmware update. Firmware update requires a PC with OS Windows XP or WIN7 and an RS-232 port (or USB to RS-232). Customer is responsible for implementing a firmware update and accepts all risks. Others limitations may apply.

LEARNING EDID #2	Passing EDID From Destination To Source
<p><b>Multiple Learning mode #2 EDID setup</b>            Press  <b>EDID &gt; OFF &gt; DESTINATION #1 THRU #8 &gt; ENTER</b></p>    	<p>The EDID for HDMI has been Learned from the Destination port to the Source port.</p> <ol style="list-style-type: none"> <li>1. Press <b>EDID</b> button. The LCM will show the current EDID status.</li> <li>2. Press <b>OFF</b> button. The LCM will show the current EDID LEARN status.</li> <li>3. Press <b>DESTINATION #1 THRU #8</b> The switcher will LEARN the destination HDMI EDID and pass to the selected source. Switcher will Enable or Disable HDMI EDID for the selected source.</li> <li>4. Press <b>ENTER</b> to confirm changes. The LCM will return to the default screen showing selected matrix routing status.</li> </ol>
<p><b>NOTE:</b> When the Source has “Learned” the EDID data from a destination, it will save that EDID information into EPROM and the EDID data will not change. To change a saved HDMI EDID information, you have to select a new LEARNING destination to source or Disable the LEARNING</p>	

# TYPICAL APPLICATION

## INSTALLING DIAGRAM

### Sample Connection:

1. Using IR External, RS-232 or Ethernet commands to control the SB-5688CAP via PC or SB-100 IR receiver to transmit the SB-5688CAP's IR signal.
2. Audio output link ARC from TV return channel, HDMI audio source or mixing Auxiliary audio.

### NOTE:

1. Switcher IR External Port: Use SB-100 IR signal Receiver
2. Control HDMI TV ARC: Use SB-5688CAP ARC function
3. Control Switch via a PC RS-232
4. Control Switch via a PC Ethernet

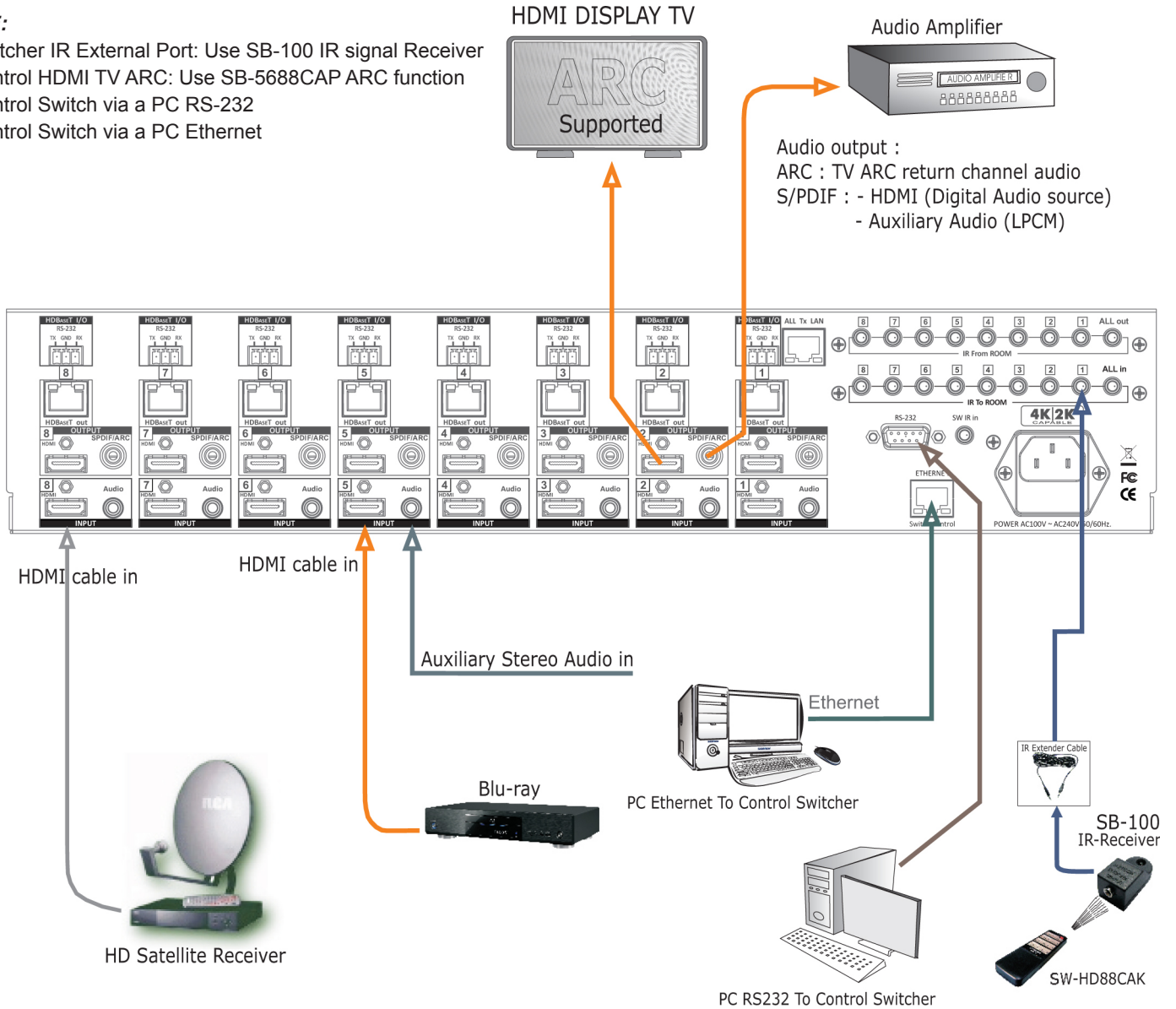

The RS-232 application, IR and Ethernet control the switcher.

# TYPICAL APPLICATION

## INSTALLING DIAGRAM

### Sample Connection:

Using SB-5688CAP HDBaseT™ Transmitter and one HDBaseT™ Receiver (SB-6320R) to control a projector via RS-232 or IR signals.

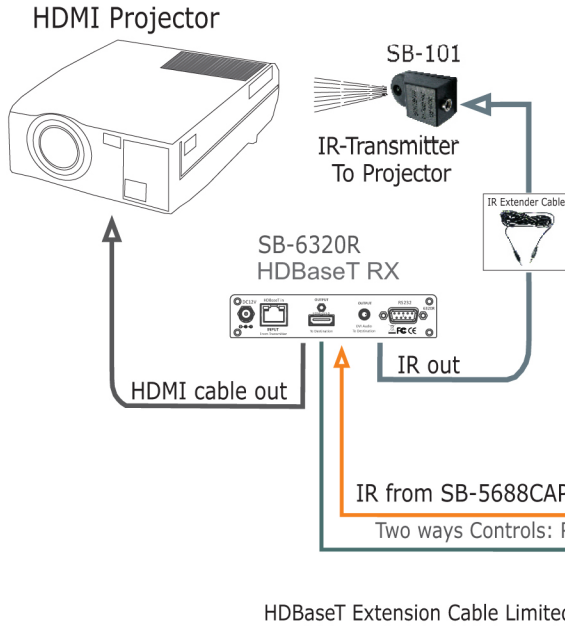

### NOTE:

1. IR Control Projector Over HDBaseT™ Extender: SB-5688CAP HDBaseT™ Transmitter / SB-6320R HDBaseT™ Receiver
2. Projector RS-232 control by a PC via the HDBaseT™ Extender
3. Projector IR control via the HDBaseT™ Extender IR in/out
4. IR Extender Transmitter (SB-101): Use the SB-101 IR Transmitter to send IR signal to Projector
5. IR Extender Receiver (SB-100): Use the SB-100 IR Receiver to receive the Projector IR Remote signal

HDBaseT Extension Cable Limited to 330 feet (100M)

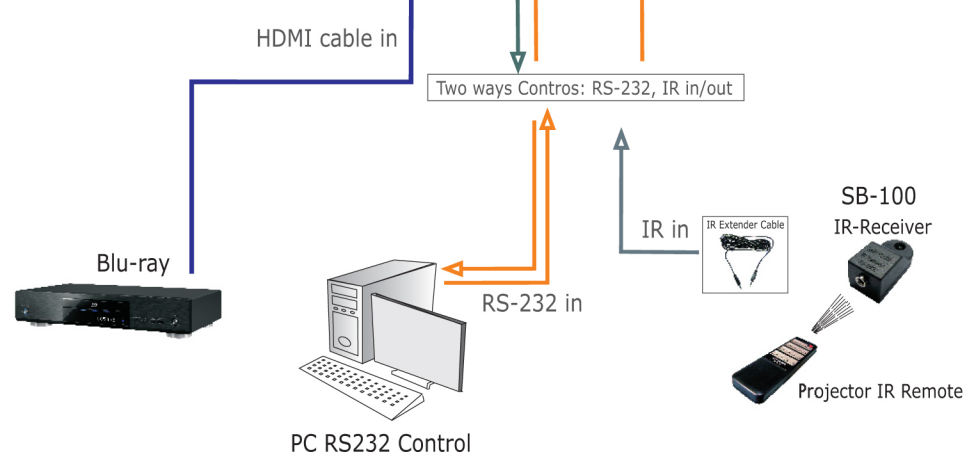
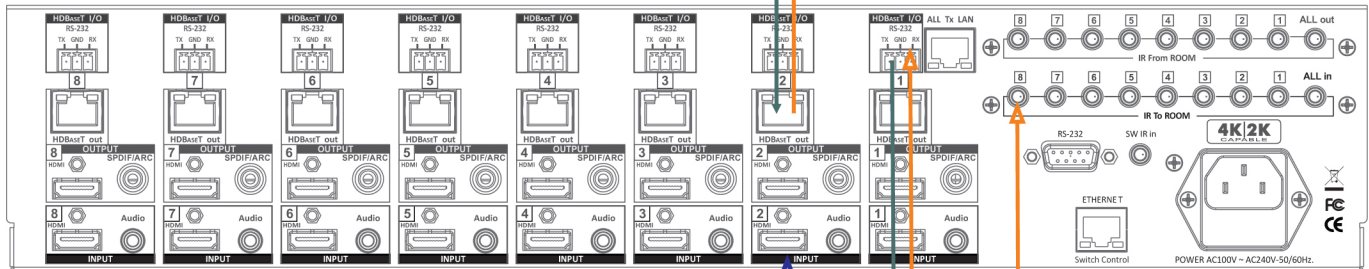



# TYPICAL APPLICATION

## INSTALLING DIAGRAM

### Sample Connection:

Using SB-5688CAP with IR Transmitters (SB-101) via SB-6320R to control a IR signal from Satellite Receiver.

### NOTE:

1. IR Control Satellite Receiver Over HDBaseT™ Extender via CAT6/6a/7 cable:

HDBaseT™ Transmitter: SB-5688CAP

HDBaseT™ Receiver: SB-6320R

2. IR Extender Transmitter (SB-101): Use the SB-101 IR Transmitter to extend the IR signal to the Satellite Receiver player

\* HDBaseT™ extender used category CAT6/6a/7 cable

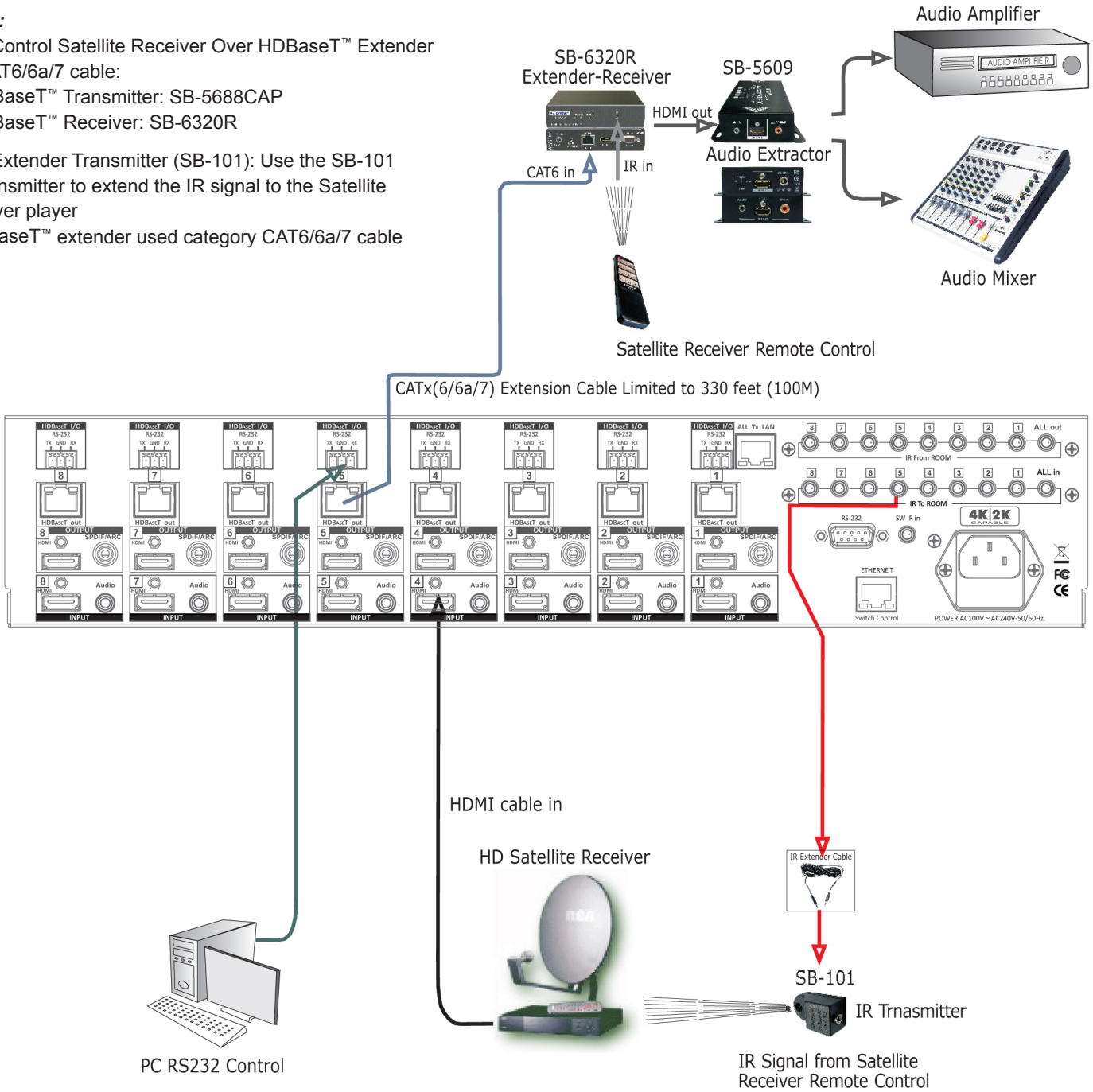

Supports HDBaseT™ Extender by Switcher Transmitter and SB-6320R Receiver via CAT6/6a/7 cable.

# IR EXTENDER

## IR EXTENDER

### 1. SB-100 IR 300M Receiver

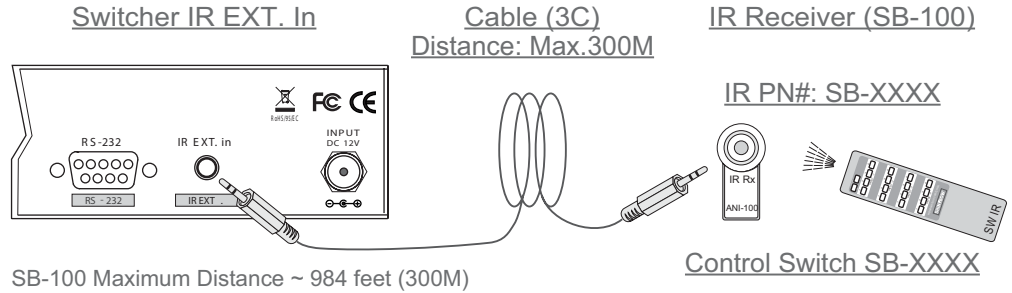

The SB-100 IR Receiver is required when using the port "ALL in" Jack.

### 2. SB-100C IR 2M Receiver

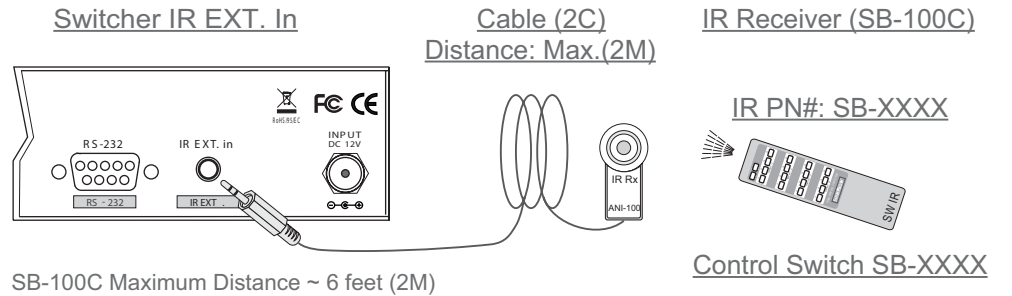

The SB-100C IR Receiver will not function on the port "ALL in" Jack.

\*\*\* When you plug the External IR extender into the switcher, the front panel IR receiver remains active. \*\*\*

Pin configuration for IR 984 feet (300M) Extender Receiver such as SB-100 compatible

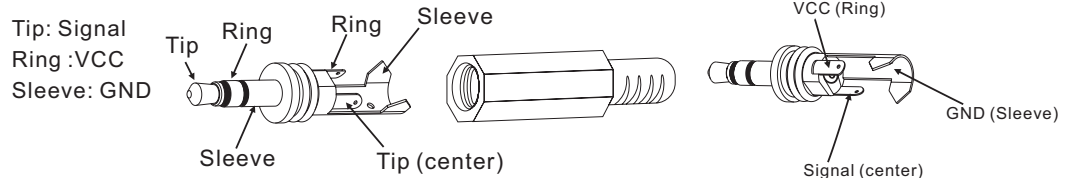

SB-100 Receiver and SB-101 Transmitter The DISTANCE maximum ~ 984 feet (300M)

Pin configuration for IR Receiver 6 feet (2M) cable such as SB-100C compatible

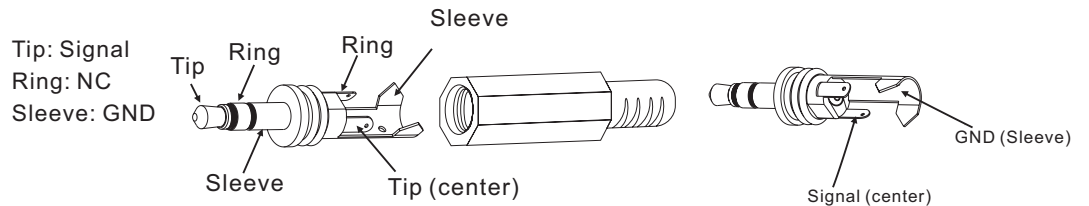

SB-100 Receiver and SB-101C Transmitter The DISTANCE maximum ~ 984 feet (300M)

**Note:** The External IR jack has voltage on the "Ring" portion of a 3-conductor plug. You must use a 3-conductor plug (aka: stereo plug). Using a 2-conductor plug will short out the power supply. Always make connections with the switcher power off.

# IR EXTENDER

## IR EXTENDER

### 1. SB-101 IR 300M Transmitter

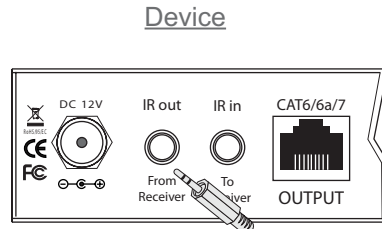

Cable (3C)

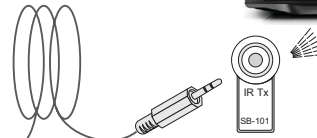

IR Transmitter (SB-101)



SB-101 Maximum Distance ~ 984 feet (300M)

### 2. SB-101C IR 2M Transmitter

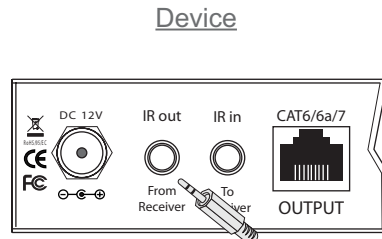

Cable (3C)

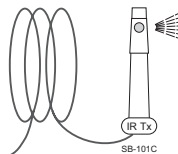

IR Transmitter (SB-101C)



SB-101C Maximum Distance ~ 6 feet (2M)

\*\*\* When you plug the External IR extender into the switcher, the front panel IR transmitter remains active. \*\*\*

## PIN CONFIGURATION:

### SB-101 and SB-101C Transmitter Pin configuration



Tip: Signal  
Ring :VCC  
Sleeve: GND

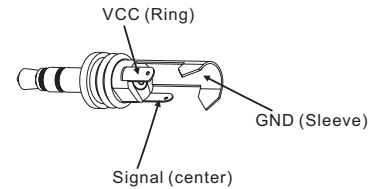
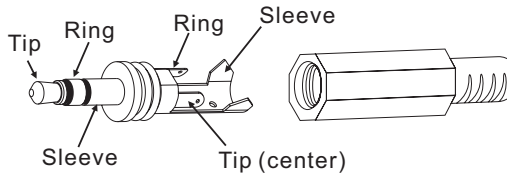

SB-101 Maximum Distance ~ 984 feet (300M)



Tip: Signal  
Ring: NC  
Sleeve: GND

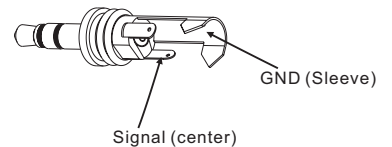
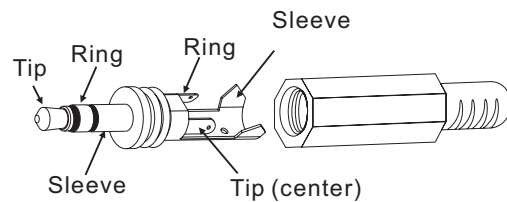

SB-101C Maximum Distance ~ 6 feet (2M)

**Note:** The External IR jack has voltage on the "Ring" portion of a 3-conductor plug. You must use a 3-conductor plug (aka: stereo plug). Using a 2-conductor plug will short out the power supply. Always make connections with the switcher power off.

# ETHERNET & RS-232 SERIAL INTERFACE

## ETHERNET SERIAL INTERFACE TO CONNECT A PC OR CONTROL SYSTEM - VERSION COMPATIBLE V2.0

For a complete list of commands, please reference external document extended Ethernet Protocol Instruction Manual.

### Ethernet

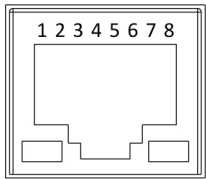

SPD LINK

Note :

Control the switcher

SPD : Speed

LINK : Ethernet link

RJ-45 Female 8P-8 Connector

### ETHERNET SERIAL INTERFACE

Pin	Ethernet	Reference
1	TXOP	TX +
2	TXON	TX -
3	RXIP	RX +
4	NC	
5	NC	
6	RXIN	RX -
7	NC	
8	GND	

### ETHERNET TCP/IP PROTOCOL COMMANDS ( ETHERNET / RS-232 CONTROL DRIVER V2.0.1 )

\*\*\* The Ethernet port and RS-232 port cannot be used simultaneously. Any connection to the Ethernet Control port will disable serial commands send to the RS-232 port.\*\*\*

## RS-232 SERIAL INTERFACE TO CONNECT A PC OR CONTROL SYSTEM - VERSION COMPATIBLE V2.0

For a complete list of commands, please reference external document extended RS-232 Protocol Instruction Manual.

### RS-232 Configuration

RS-232 cable is a straight thru cable and not null-modem

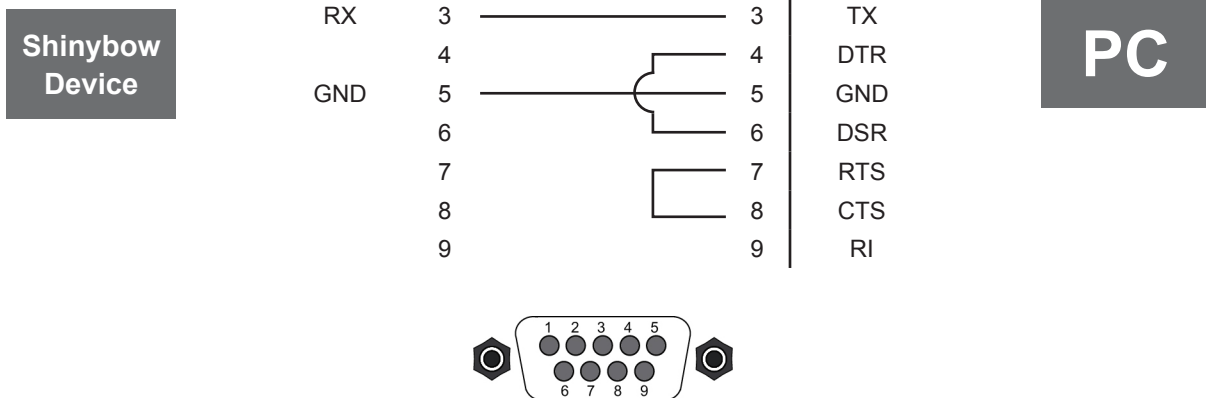

### RS-232 SERIAL INTERFACE PROTOCOL COMMANDS ( ETHERNET / RS-232 CONTROL DRIVER V2.0 )

The Shinybow switcher can be controlled via the RS-232 serial control port to allow for interfacing to a PC, or similar third party control system.

The serial communication parameters are 9600 baud, 8 bit, No Parity and 1 stop bit - this is often referred to as 9600 8N1. When the unit recognises a complete command it will perform the requested action - there is no delimiter character required.



THIS PAGE IS INTENTIONALLY LEFT BLANK.

# LIMITED WARRANTY

PLEASE READ THE FOLLOWING TERMS AND CONDITIONS CAREFULLY BEFORE USING THIS HARDWARE, COMPONENTS AND SOFTWARE PROVIDED BY, THROUGH OR UNDER SHINYBOWUSA, INC (COLLECTIVELY, THE "PRODUCT"). By using installing or using the Product, you unconditionally signify your agreement to these Terms and Conditions. If you do not agree to these Terms and Conditions, do not use the Product and return the Product to SHINYBOWUSA, Inc. at the return address set forth on the Product's packing label at your expense. SHINYBOWUSA, Inc. may modify these Terms and Conditions at anytime, without notice to you.

## RESTRICTIONS ON USE OF THE PRODUCT

It is your responsibility to read and understand the installation and operation instructions, both verbal and in writing, provided to you with respect to the Product. You are authorized to use the Product solely in connection with such instructions. Any use of the Product not in accordance with such instructions shall void any warranty pertaining to the Product. Any and all damages that may occur in the use of the Product that is not strictly in accordance with such instructions shall be borne by you and you agree to indemnify and hold harmless SHINYBOWUSA, Inc. from and against any such damage.

The Product is protected by certain intellectual property rights owned by or licensed to SHINYBOWUSA. Any intellectual property rights pertaining to the Product are licensed to you by SHINYBOWUSA, Inc. and/or its affiliates, including any manufacturers or distributors of the Product (collectively, "SHINYBOWUSA") for your personal use only, provided that you do not change or delete any proprietary notices that may be provided with respect to the Product.

The Product is sold to you and any use of any associated intellectual property is deemed to be licensed to you by SHINYBOWUSA for your personal use only. SHINYBOWUSA does not transfer either the title or the intellectual property rights to the Product and SHINYBOWUSA retains full and complete title to the intellectual property rights therein. All trademarks and logos are owned by SHINYBOWUSA or its licensors and providers of the Product, and you may not copy or use them in any manner without the prior written consent of SHINYBOWUSA, which consent may be withheld at the sole discretion of SHINYBOWUSA.

The functionality and usability of the Product is controlled by SHINYBOWUSA, Inc. from its offices within the State of Texas, United States of America. SHINYBOWUSA makes no representation that materials pertaining to the Product are appropriate or available for use in other locations other than the shipping address you provided with respect thereto. You are advised that the Product may be subject to U.S. export controls.

## DISCLAIMERS AND LIMITATION OF LIABILITY

SHINYBOWUSA may change or modify the Product at any time, from time to time.

THE PRODUCT IS PROVIDED "AS IS" AND WITHOUT WARRANTIES OF ANY KIND EITHER EXPRESS OR IMPLIED. SHINYBOWUSA DOES NOT WARRANT OR MAKE ANY REPRESENTATIONS REGARDING THE USE OR THE RESULTS OF THE USE OF THE PRODUCT'S CORRECTNESS, ACCURACY, RELIABILITY, OR OTHERWISE.

SHINYBOWUSA has no duty or policy to update any information or statements pertaining to the Product and, therefore, such information or statements should not be relied upon as being current as of the date you use the Product. Moreover, any portion of the materials pertaining to the Product may include technical inaccuracies or typographical errors. Changes may be made from time to time without notice with respect to the Product.

TO THE FULLEST EXTENT PERMISSIBLE PURSUANT TO APPLICABLE LAW, SHINYBOWUSA DISCLAIMS ALL WARRANTIES, EXPRESS OR IMPLIED, INCLUDING, BUT NOT LIMITED TO IMPLIED WARRANTIES OF MERCHANTABILITY, FITNESS FOR A PARTICULAR PURPOSE AND NON-INFRINGEMENT. SHINYBOWUSA DOES NOT WARRANT THE ACCURACY, COMPLETENESS OR USEFULNESS OF ANY INFORMATION WITH RESPECT TO THE PRODUCT. SHINYBOWUSA DOES NOT WARRANT THAT THE FUNCTIONS PERTAINING TO THE PRODUCT WILL BE ERROR-FREE, THAT DEFECTS WITH RESPECT TO THE PRODUCT WILL BE CORRECTED, OR THAT THE MATERIALS PERTAINING THERETO ARE FREE OF DEFECTS OR OTHER HARMFUL COMPONENTS. SHINYBOWUSA WILL USE ITS REASONABLE EFFORTS TO CORRECT ANY DEFECTS IN THE PRODUCT UPON TIMELY WRITTEN NOTICE FROM YOU NOT TO EXCEED 10 BUSINESS DAYS AFTER RECEIPT BY YOU OF THE PRODUCT, BUT YOU (AND NOT SHINYBOWUSA) ASSUME THE ENTIRE COST OF ALL NECESSARY SERVICING, REPAIR AND CORRECTION THAT WAS CAUSED BY YOU UNLESS OTHERWISE AGREED TO IN A SEPARATE WRITING BY SHINYBOWUSA.

UNDER NO CIRCUMSTANCES, INCLUDING, BUT NOT LIMITED TO, NEGLIGENCE, SHALL SHINYBOWUSA BE LIABLE FOR ANY SPECIAL OR CONSEQUENTIAL DAMAGES THAT RESULT FROM THE USE OF, OR THE INABILITY TO USE THE PRODUCT IN ACCORDANCE WITH ITS SPECIFICATIONS, EVEN IF SHINYBOWUSA OR ITS REPRESENTATIVES HAVE BEEN ADVISED OF THE POSSIBILITY OF SUCH DAMAGES. IN NO EVENT SHALL SHINYBOWUSA'S TOTAL LIABILITY TO YOU FROM ALL DAMAGES, LOSSES, AND CAUSES OF ACTION (WHETHER IN CONTRACT, OR OTHERWISE) EXCEED THE AMOUNT YOU PAID TO SHINYBOWUSA, IF ANY, FOR THE PRODUCT.

**END OF DOCUMENT**

122 Rose Ln. Suite 303 | Frisco, Texas 75034

1-877-SHINY-USA

1-877-744-6987

1-972-377-2508

[sales@shinybowusa.com](mailto:sales@shinybowusa.com)

[www.shinybowusa.com](http://www.shinybowusa.com)

**SHINYBOW™ USA**  
MULTIMEDIA AUDIO AND VISUAL