

N6 Series Standalone DVR User's Manual

Version 5.1.0

Table of Contents

1	FEATURES AND SPECIFICATIONS.....	1
1.1	Overview	1
1.2	Features	1
1.3	Specifications	2
1.3.1	General 1U Series	2
1.3.2	960H 1U Series.....	6
1.3.3	Full-D1 1.5U Series	9
1.3.4	HD-SDI 1080P 1.5U Series.....	12
1.3.5	Simple 1.5 U Series.....	15
1.3.6	960H 4HDD 1.5U Series.....	19
1.3.7	960H 2HDD 1.5U Series.....	22
1.3.8	General 2U Series	25
1.3.9	HD-SDI 1080P 2U Series	28
1.3.10	960H 2U Series	32
2	OVERVIEW AND CONTROLS	36
2.1	Front Panel.....	36
2.1.1	1U series	36
2.1.2	1.5U series.....	37
2.1.3	2U series	39
2.2	Rear Panel.....	42
2.2.1	1U series	42
2.2.2	960H 1U Series.....	42
2.2.3	Full-D1 1.5U series.....	43
2.2.4	HD-SDI 1080P 1.5U Series.....	44
2.2.5	Simple 1.5U Series.....	45
2.2.6	960H 4HDD 1.5U Series.....	46
2.2.7	960H 2HDD 1.5U Series.....	46
2.2.8	General 2U Series	47
2.2.9	HD-SDI 1080P 2U Series	49
2.2.10	960H 2U Series	50

2.3	Connection Sample	51
2.3.1	General 1U series.....	51
2.3.2	960H 1U Series.....	51
2.3.3	General 1.5U series.....	52
2.3.4	HD-SDI 1.5U Series	53
2.3.5	960H 4HDD 1.5U Series.....	54
2.3.6	960H 2HDD 1.5U Series.....	55
2.3.7	General 2U series.....	56
2.3.4	HD-SDI 1080P 2U Series	57
2.3.4	960H 2U Series.....	58
2.4	Remote Control	59
2.5	Mouse Control	61
2.6	Virtual Keyboard & Front Panel	63
2.6.1	Virtual Keyboard.....	63
2.6.2	Front Panel	63
3	INSTALLATION AND CONNECTIONS	64
3.1	Check Unpacked DVR	64
3.2	About Front Panel and Real Panel	64
3.3	HDD Installation	64
3.3.1	1U series	64
3.3.2	1.5U series.....	65
3.3.3	2U series (HD-SDI series, 960H)	65
3.4	Rack Installation	66
3.5	Connecting Power Supply	66
3.6	Connecting Video Input and Output Devices	66
3.6.1	Connecting Video Input.....	67
3.6.2	Connecting Video Output.....	67

3.7	Connecting Audio Input & Output, Bidirectional Audio	67
3.7.1	Audio Input.....	67
3.7.2	Audio Output.....	67
3.8	Alarm Input and Output Connection	68
3.8.1	Alarm Input and Output Details.....	68
3.8.2	Alarm Input Port	74
3.8.3	Alarm Output Port	75
3.9	RS232.....	75
3.10	RS485.....	75
3.11	Other Interfaces	76
4	OVERVIEW OF NAVIGATION AND CONTROLS	78
4.1	Login, Logout & Main Menu	78
4.1.1	Login	78
4.1.2	Main Menu	79
4.1.3	Logout.....	79
4.1.4	Auto Resume after Power Failure	80
4.1.5	Replace Button Battery	80
4.2	Live Viewing	80
4.3	Manual Record.....	81
4.3.1	Manual record menu	81
4.3.2	Basic operation.....	81
4.3.3	Enable/disable record.....	82
4.3.4	Enable all channel recording.....	82
4.3.5	Stop all channel recording	83
4.4	Search & Playback	84
4.5	Schedule	87
4.5.1	Schedule Menu	87

4.5.2	Snapshot	90
4.5.3	Image FTP	91
4.6	Detect	92
4.6.1	Go to Detect Menu.....	92
4.6.2	Motion Detect	92
4.6.3	Video Loss	94
4.6.4	Camera Masking.....	95
4.7	Alarm Setup and Alarm Activation	96
4.7.1	Go to alarm setup interface	96
4.7.2	Alarm setup.....	96
4.8	Backup	99
4.7.1	Detect Device.....	99
4.8.1	Backup.....	99
4.9	PTZ Control and Color Setup	100
4.8.1	Cable Connection	101
4.8.2	PTZ Setup.....	101
4.8.3	3D Intelligent Positioning Key.....	102
4.10	Preset/ Patrol/Pattern/Scan.....	103
4.9.1	Preset Setup	104
4.9.2	Activate Preset.....	104
4.9.3	Patrol setup (Tour Setup).....	104
4.9.4	Activate Patrol (tour).....	105
4.9.5	Pattern Setup	105
4.9.6	Activate Pattern Function	105
4.9.7	Auto Scan Setup	105
4.9.8	Activate Auto Scan.....	105
4.11	Flip	105
5	UNDERSTANDING OF MENU OPERATIONS AND CONTROLS	107
5.1	Menu Tree	107
5.2	Main Menu.....	107

5.3	Setting	108
5.3.1	General.....	108
5.3.2	Encode	110
5.3.3	Schedule	112
5.3.4	RS232.....	112
5.3.5	Network	113
5.3.6	Alarm.....	128
5.3.7	Detect	128
5.3.8	Pan/Tilt/Zoom	128
5.3.9	Display	129
5.3.10	Default.....	130
5.4	Search.....	131
5.5	Advanced.....	131
5.5.1	HDD Management.....	132
5.5.2	Abnormity	135
5.5.3	Alarm Output.....	136
5.5.4	Manual Record.....	136
5.5.5	Account.....	136
5.5.6	Auto Maintenance	138
5.5.7	TV Adjust.....	139
5.5.8	Video Matrix.....	139
5.5.9	Card Overlay.....	140
5.5.10	Config File Backup.....	141
5.6	Information.....	142
5.6.1	HDD Information	142
5.6.2	BPS.....	143
5.6.3	Log	143
5.6.4	Version	144
5.6.5	Online Users.....	145
5.7	Shutdown.....	145
6	ABOUT AUXILIARY MENU	147
6.1	Go to Pan/Tilt/Zoom Menu	147
6.1.1	3D Intelligent Positioning Key	147

6.2	Preset /Patrol / Pattern /Border Function.....	148
6.2.1	Preset Setup.....	149
6.2.2	Activate Preset	149
6.2.3	Patrol Setup.....	149
6.2.4	Activate Patrol	149
6.2.5	Pattern Setup.....	149
6.2.6	Activate Pattern Function.....	150
6.2.7	Border Setup.....	150
6.2.8	Activate Border Function	150
6.2.9	Flip	150
7	WEB CLIENT OPERATION	152
7.1	Network Connection.....	152
7.2	Login.....	152
7.3	LAN Mode.....	154
7.3.1	Real-time Monitor.....	155
7.3.2	PTZ	157
7.3.3	Color	160
7.3.4	Picture Path and Record Path	160
7.4	WAN Login.....	161
7.5	Configure	163
7.5.1	System Information.....	163
7.5.2	System Configuration	166
7.5.3	Advanced	187
7.5.4	Additional Function	194
7.6	Search.....	198
7.7	Alarm	201
7.8	About	202

7.9	Log out	202
7.10	Un-install Web Control.....	202
8	PROFESSIONAL SURVEILLANCE SYSTEM	204
9	FAQ.....	205
	APPENDIX A HDD CAPACITY CALCULATION	210
	APPENDIX B COMPATIBLE BACKUP DEVICE LIST.....	211
	APPENDIX C COMPATIBLE CD/DVD DEVICE LIST.....	215
	APPENDIX D COMPATIBLE DISPLAYER LIST	216
	APPENDIX E COMPATIBLE SWITCHER LIST	217
	APPENDIX F COMPATIBLE WIRELESS MOUSE LIST.....	218
	APPENDIX G EARTHING.....	219
	APPENDIX H TOXIC OR HAZARDOUS MATERIALS OR ELEMENTS.....	224

Welcome

Thank you for purchasing our DVR!

This user's manual is designed to be a reference tool for the installation and operation of your system.

Here you can find information about this series DVR features and functions, as well as a detailed menu tree.

Before installation and operation please read the following safeguards and warnings carefully!

Important Safeguards and Warnings

1 . Electrical safety

All installation and operation here should conform to your local electrical safety codes. We assume no liability or responsibility for all the fires or electrical shock caused by improper handling or installation.

2 . Transportation security

Heavy stress, violent vibration or water splash are not allowed during transportation, storage and installation.

3 . Installation

Keep upwards. Handle with care.

Do not apply power to the DVR before completing installation.

Do not place objects on the DVR

4 . Qualified engineers needed

All the examination and repair work should be done by the qualified service engineers.

We are not liable for any problems caused by unauthorized modifications or attempted repair.

5 . Environment

The DVR should be installed in a cool, dry place away from direct sunlight, inflammable, explosive substances and etc.

This series product shall be transported, storage and used in the environment ranging from 0°C to 55 °C

6. Accessories

Be sure to use all the accessories recommended by manufacturer.

Before installation, please open the package and check all the components are included.

Contact your local retailer ASAP if something is broken in your package.

7. Lithium battery

Improper battery use may result in fire, explosion, or personal injury!

When replace the battery, please make sure you are using the same model!

1 FEATURES AND SPECIFICATIONS

1.1 Overview

This series product is an excellent digital monitor product designed for security field. It adopts embedded Linux OS to maintain reliable operation. Popular H.264 compression algorithm and G.711 audio compression technology realize high quality, low bit stream. Unique frame by frame play function is suitable for detail analysis. It has various functions such as record, playback, monitor at the same time and can guarantee audio video synchronization. This series product has advanced technology and strong network data transmission function.

This series device adopts embedded design to achieve high security and reliability. It can work in the local end, and at the same time, when connecting it to the professional surveillance software (PSS), it can connect to security network to realize strong network and remote monitor function.

This series product can be widely used in various areas such as banking, telecommunication, electric power, interrogation, transportation, intelligent resident zone, factory, warehouse, resources, and water conservancy.

1.2 Features

This series product has the following features:

- **Real-time monitor**

It has analog output port, VGA port and HDMI port. You can use monitor or displayer to realize surveillance function.

System supports TV/VGA/HDMI output at the same time.

- **Storage function**

Special data format to guarantee data security and can avoid vicious data modification.

- **Compression format**

Support multiple-channel audio and video. An independent hardware decodes the audio and video signal from each channel to maintain video and audio synchronization.

- **Backup function**

Support backup operation via USB port (such as flash disk, portable HDD, burner).

Client-end user can download the file to local HDD to backup via network.

- **Record playback function**

Support each channel real-time record independently, and at the same time it can support search, forward play, network monitor, record search, download and etc.

Support various playback modes: slow play, fast play, backward play and frame by frame play.

Support time title overlay so that you can view event accurate occurred time

Support specified zone enlargement.

- **Network operation**

Support network remote real-time monitor, remote record search and remote PTZ control.

- **Alarm activation function**

Several relay alarm outputs to realize alarm activation and on-site light control.

The alarm input port and output has the protection circuit to guarantee device safety.

- **Communication port**

RS485 port can realize alarm input and PTZ control.

RS232 port can connect to keyboard to realize central control, and can also connect to PC COM to upgrade system and realize maintenance, and matrix control.

Standard Ethernet port can realize network access function.

Dual Ethernet ports support configuration modes such as multiple access, Fault-tolerance and load balancing.

- **PTZ control**

Support PTZ decoder via RS485.

Support various decode protocols to allow the PTZ to control the speed dome.

- **Intelligent operation**

Mouse operation function

In the menu, support copy and paste setup function

- **UPnP**

It is to establish the mapping relationship between the LAN and the WAN via the UPnP protocol.

Slight function differences may be found due to different series.

1.3 Specifications

1.3.1 General 1U Series

	Parameter	4-ch	8-ch	16-ch
System	Main Processor	High-performance industrial embedded micro controller		
	OS	Embedded LINUX		
	System Resources	Multiplex operations: Multiple-channel record, multiple-channel playback and network operation simultaneously		
	Interface	User-friendly graphical user interface		
	Input Devices	Front panel, USB mouse		
	Input Method	Arabic number, English character, donation and extension Chinese (optional)		
	Shortcut Function	Copy/paste operation, USB mouse right-key shortcut menu, double click USB mouse to switch screen.		
Compression Standard	Video Compression	H.264		

	Audio Compression	G.711A		
Video monitor	Video Input	4-CH composite video input: (NTSC/PAL) BNC (1.0V _{P-P} , 75Ω)	8-CH composite video input: (NTSC/PAL) BNC (1.0V _{P-P} , 75Ω)	16-CH composite video input: (NTSC/PAL) BNC (1.0V _{P-P} , 75Ω)
	Video Output	1-ch PAL/NTSC, BNC (1.0V _{P-P} , 75Ω) composite video signal output. 1-ch VGA output. 1-ch HDMI output. 1-ch matrix output. Support TV/VGA/HDMI video output at the same time.		
	Video Standard	PAL (625 line, 50f/s), NTSC (525 line, 60f/s)		
	Record Speed	Real-time Mode: PAL 1f/s to 25f/s per channel and NTSC 1f/s to 30f/s per channel		
	Video Partition	1/4 windows(Optional)	1/4/8/9 windows	1/4/8/9 /16 windows
	Monitor Touring	Support monitor tour functions such as alarm, motion detection, and schedule auto control.		
	Resolution (PAL/NTSC)	PAL/NTSC Real-time monitor: D1 704×576/704×480		
		Playback: 1/16-ch: D1 704×576/704×480, HD1 704×288/704×240, 2CIF 352×576/352×480, CIF 352×288/ 352×240 , QCIF 176×144/176×120		
		Support dual streams: extra stream resolution CIF 352×288/ 352×240, QCIF 176×144/176×120.		
	Image Quality	6-level image quality (Adjustable)		
	Privacy mask	Support one privacy mask of user-defined size in full screen. Support max 4 zones.		
	Image Information	Channel information, time information and privacy mask zone.		
	TV Adjust	Adjust TV output zone suitable to anamorphic video.		
Channel Lock	Cover secret channel with black screen though system is encoding normally. Screen-lock function to prevent unauthorized user seeing secret video.			
Channel Information	Channel name, recording status, screen lock status, video loss status and motion detection status are shown on the bottom left of display screen.			
Color Configuration	Hue, brightness, contrast, saturation and gain setup for each channel.			
Audio	Audio Input	4-ch 200-2000mv 10KΩ(BNC)	8-ch 200-2000mv 10KΩ(BNC)	4-ch 200-2000mv 10KΩ (BNC)
	Audio Output	1-ch audio output 200-3000mv 5KΩ(BNC)	1-ch audio output 200-3000mv 5KΩ(BNC)	1-ch audio output 200-3000mv 5KΩ(RCA)

	Bidirectional Audio	1-ch audio talk output 200-3000mv 5K Ω (BNC)	1-ch audio talk output 200-3000mv 5K Ω (BNC)	1-ch audio talk output 200-3000mv 5K Ω (RCA)
Hard disk	Hard Disk	2 built-in SATA port. Support 2 HDDs.		
	Hard Disk Occupation	Audio: PCM 28.8MByte/h Video: 56-900MByte/h		
Record and playback	Recording Mode	Manual recording, motion detection recording, schedule recording and alarm recording Priority: Manual recording> alarm recording>motion detection recording>schedule recording.		
	Recording Length	1 to 120 minutes single record duration (Default setup is 60 minutes)		
	Playback Repeat Way	When hard disk is full, system can overwrite previous video file.		
	Record Search	Various search engines such as time, type and channel.		
	Playback Mode	Various fast play, slow play speeds, manual frame by frame playback and reverse play mode.		
	Various File Switch Ways	Can switch to previous or next file or any file in current play list. Can switch to file on other channel of the same time. (If there is a file) Support file continuous play, when a file is end system auto plays the next file in the current channel		
	Multi-channel Playback	There is 1/4/9/16-channel playback mode. (It may vary due to different series.)		
	Window Zoom	Switch between self-adaptive screen/full screen when playback		
	Partial Enlargement	When in one-window full-screen playback mode, you can select any zone to activate partial enlargement function.		
	Backup function	Backup Mode	HDD backup	
Support peripheral USB backup device. (Flash disk, portable disk and etc.)				
Support peripheral USB burner.				
Support network download and backup				
Network Function	Network control	View monitor channel remotely.		
		DVR configuration through client-end and web browser		
		Upgrade via client or browser to realize remote maintenance.		
		View alarm information such as external alarm, motion detection and video loss via client.		
		Support network PTZ lens control		
		File download backup and playback		
		Multiple devices share information via corresponding software such as professional surveillance software (PSS)		
		Duplex transparent COM		
		Network alarm input and output		
		Bidirectional audio.		
Motion Detection and Alarm	Motion Detection	Zone setup: support 396((PAL 22 \times 18, NTSC 22 \times 15)) detection zones. Various sensitivity levels. Alarm can activate record or external alarm or screen message prompt.		
	Video Loss	Alarm can activate external alarm or screen message prompt.		
	External Alarm	Support record activation function or activate external alarm or screen message in specified period.		

	Manual Alarm Control	Enable or disable alarm input channel Support analog alarm signal to specific alarm output channel.		
	Alarm Input	4-ch alarm input (You can set normal open or normal close type to select the alarm type.)	8-ch alarm input (You can set normal open or normal close type to select the alarm type.)	16-ch alarm input (You can set normal open or normal close type to select the alarm type.)
	Alarm Output	3-channel relay output.		
	Alarm Relay	30V DC 2A, 125VAC 1A (activation alarm)		
Interface	USB Interface	2 USB 2.0 ports.		
	Network connection	RJ45 10M/100M/1000M self-adaptable Ethernet port		
	RS485	PTZ control port Support various PTZ control protocols.		
	RS232	Ordinary COM (Debug), keyboard connection and transparent serial port(COM input and output via network)		
System Information	Hard Disk Information	Display HDD current status		
	Data Stream Statistics	Data stream statistics for each channel (in wave mode)		
	Log statistics	Backup to 1024 log files. Support various search engines such as time and type.		
	Version	Display version information: channel amount, alarm input and output amount, system version and release date.		
	On-line user	Display current on-line user		
User Management	User Management	Multi-lever user management; various management modes Integrated management for local user, serial port user and network user. Configurable user power.		
		Support user /group and its corresponding rights modification. No limit to the user or group amount.		
	Password Authentication	Password modification Administrator can modify other user's password. Account lock strategy Five times login failure in thirty minutes may result in account lock.		
Upgrade		Web browser, client-end and update tool.		
Login, Logout and Shutdown		Password login protection to guarantee safety		
		User-friendly interface when login. Provide the following options: Logout /shutdown/ restart.		
		Right authentication when shut down to make sure only those proper people can turn off DVR		
General Parameter	Power	DC 12V		
	Power Consumption	≤25w (With adapter, exclude HDD)		
	Working Temperature	0℃ – +55℃		
	Working Humidity	10% – 90%		
	Air Pressure	86kpa – 106kpa		

	Dimension	1U standard industrial case. 375(W) x280 (D) x50mm(H)
	Weight	1.5-2.5KG(Exclude HDD)
	Installation Mode	Desktop installation

1.3.2 960H 1U Series

	Parameter	4-ch	8-ch	16-ch
System	Main Processor	High-performance industrial embedded micro controller		
	OS	Embedded LINUX		
	System Resources	Multiplex operations: Multiple-channel record, multiple-channel playback and network operation simultaneously		
	Interface	User-friendly graphical user interface		
	Input Devices	Front panel, USB mouse, remote control		
	Input Method	Arabic number, English character, donation and extension Chinese (optional)		
	Shortcut Function	Copy/paste operation, USB mouse right-key shortcut menu, double click USB mouse to switch screen.		
Compression Standard	Video Compression	H.264		
	Audio Compression	G711A, G711U, PCM		
Video monitor	Video Input	4-CH composite video input: (NTSC/PAL) BNC (1.0VB _{P-P, B} 75Ω)	8-CH composite video input: (NTSC/PAL) BNC (1.0VB _{P-P, B} 75Ω)	16-CH composite video input: (NTSC/PAL) BNC (1.0VB _{P-P, B} 75Ω)
	Video Output	1-ch PAL/NTSC, BNC (1.0VP- P, 75Ω) composite video signal output. 1-ch VGA output. 1-ch HDMI output. 1-ch matrix output. Support TV/VGA/HDMI video output at the same time.		
	Video Standard	PAL (625 line, 50f/s), NTSC (525 line, 60f/s)		
	Record Speed	Real-time Mode: PAL 1f/s to 25f/s per channel and NTSC 1f/s to 30f/s per channel		
	Video Partition	1/4 windows(Optional)	1/4/8/9 windows	1/4/8/9 /16 windows
	Monitor Touring	Support monitor tour functions such as alarm, motion detection, and schedule auto control.		
	Resolution (PAL/NTSC)	PAL(625TVL, 50f/s)/NTSC(525TVL, 60f/s) Real-time monitor: 960H 960 ×576/960×480		
		Playback channel 1/16: 960 ×576/960×480 D1 704×576/704×480 、 CIF 352×288/ 352×240 、 QCIF 176×144/176×120		
		Support dual streams. Extra stream resolution: CIF 352×288/ 352×240 QCIF 176×144/176×120		
	Image Quality	6-level image quality (Adjustable)		
Privacy mask	Support one privacy mask of user-defined size in full screen. Support max 4 zones.			

	Image Information	Channel information, time information and privacy mask zone.		
	TV Adjust	Adjust TV output zone suitable to anamorphic video.		
	Channel Lock	Cover secret channel with black screen though system is encoding normally. Screen-lock function to prevent unauthorized user seeing secret video.		
	Channel Information	Channel name, recording status, screen lock status, video loss status and motion detection status are shown on the bottom left of display screen.		
	Color Configuration	Hue, brightness, contrast, saturation and gain setup for each channel.		
Audio	Audio Input	4-ch 200-2000mv 10KΩ(RCA)	8-ch 200-2000mv 10KΩ(RCA)	4-ch 200-2000mv 10KΩ (RCA)
	Audio Output	1-ch audio output 200-3000mv 5KΩ(RCA)		
	Bidirectional Audio	1-ch audio talk input 200-3000mv 10KΩ (RCA) 1-ch audio talk output 200-3000mv 5KΩ(RCA)		
Hard disk	Hard Disk	2 built-in SATA port. Support 2 HDDs.		
	Hard Disk Occupation	Audio: PCM 28.8MByte/h Video: 56-900MByte/h		
Record and playback	Recording Mode	Manual recording, motion detection recording, schedule recording and alarm recording Priority: Manual recording> alarm recording>motion detection recording>schedule recording.		
	Recording Length	1 to 120 minutes single record duration (Default setup is 60 minutes)		
	Playback Repeat Way	When hard disk is full, system can overwrite previous video file.		
	Record Search	Various search engines such as time, type and channel.		
	Playback Mode	Various fast play, slow play speeds, manual frame by frame playback and reverse play mode.		
	Various File Switch Ways	Can switch to previous or next file or any file in current play list. Can switch to file on other channel of the same time. (If there is a file) Support file continuous play, when a file is end system auto plays the next file in the current channel		
	Multi-channel Playback	There is 1/4/9/16-channel playback mode. (It may vary due to different series.)		
	Window Zoom	Switch between self-adaptive screen/full screen when playback		
	Partial Enlargement	When in one-window full-screen playback mode, you can select any zone to activate partial enlargement function.		
Backup function	Backup Mode	HDD backup		
		Support peripheral USB backup device. (Flash disk, portable disk, USB burner and etc.)		
		Support network download and backup		
Network Function	Network control	View monitor channel remotely.		
		DVR configuration through client-end and web browser		
		Upgrade via client or browser to realize remote maintenance.		
		View alarm information such as external alarm, motion detection and video loss via client.		
		Support network PTZ lens control		
		File download backup and playback		

		Multiple devices share information via corresponding software such as professional surveillance software (PSS)		
		Duplex transparent COM		
		Network alarm input and output		
		Bidirectional audio.		
		Support dual network cards mode such as multiple-address mode, fault-tolerance, and load balance.		
Motion Detection and Alarm	Motion Detection	Zone setup: support 396/330((PAL 22×18, NTSC 22×15)) detection zones. Various sensitivity levels. Alarm can activate record or external alarm or screen message prompt.		
	Video Loss	Alarm can activate external alarm or screen message prompt.		
	External Alarm	Support record activation function or activate external alarm or screen message in specified period.		
	Manual Alarm Control	Enable or disable alarm input channel Support analog alarm signal to specific alarm output channel.		
	Alarm Input	4-ch alarm input (You can set normal open or normal close type to select the alarm type.)	8-ch alarm input (You can set normal open or normal close type to select the alarm type.)	16-ch alarm input (You can set normal open or normal close type to select the alarm type.)
	Alarm Output	3-channel relay output, including one controllable DC +12V output port.		
	Alarm Relay	30V DC 2A, 125V AC 1A (activation alarm)		
Interface	USB Interface	2 USB 2.0 ports.		
	Network connection	1 RJ45 10M/100M/1000M self-adaptable Ethernet port		
	RS485	PTZ control port Support various PTZ control protocols.		
	RS232	Ordinary COM (Debug),keyboard connection and transparent serial port(COM input and output via network)		
System Information	Hard Disk Information	Display HDD current status		
	Data Stream Statistics	Data stream statistics for each channel (in wave mode)		
	Log statistics	Backup to 1024 log files. Support various search engines such as time and type.		
	Version	Display version information: channel amount, alarm input and output amount, system version and release date.		
	On-line user	Display current on-line user		
User Management	User Management	Multi-lever user management; various management modes Integrated management for local user, serial port user and network user. Configurable user power.		
		Support user /group and its corresponding rights modification. No limit to the user or group amount.		
	Password Authentication	Password modification Administrator can modify other user's password.		
		Account lock strategy Five times login failure in thirty minutes may result in account lock.		
Upgrade		Web browser, client-end and update tool.		
Login, Logout and Shutdown		Password login protection to guarantee safety		
		User-friendly interface when login. Provide the following options: Logout /shutdown/ restart.		

		Right authentication when shut down to make sure only those proper people can turn off DVR
General Parameter	Power	DC 12V
	Power Consumption	≤25W (With adapter, exclude HDD)
	Working Temperature	0°C – +55°C
	Working Humidity	10% – 90%
	Air Pressure	86kpa – 106kpa
	Dimension	1U standard industrial case. 375(W) x280 (D) x50mm(H)
	Weight	1.5-2.5KG(Exclude HDD)
	Installation Mode	Desktop installation

1.3.3 Full-D1 1.5U Series

	Parameter	4-ch	8-ch	16-ch
System	Main Processor	High-performance industrial embedded micro controller		
	OS	Embedded LINUX		
	System Resources	Multiplex operations: Multiple-channel record, multiple-channel playback and network operation simultaneously		
	Interface	User-friendly graphical user interface		
	Input Devices	Front panel, USB mouse		
	Input Method	Arabic number, English character, donation and extension Chinese (optional)		
	Shortcut Function	Copy/paste operation, USB mouse right-key shortcut menu, double click USB mouse to switch screen.		
Compression Standard	Video Compression	H.264		
	Audio Compression	G.711A		
Video monitor	Video Input	4-CH composite video input: (NTSC/PAL) BNC (1.0V _{P-P} , 75Ω)	8-CH composite video input: (NTSC/PAL) BNC (1.0V _{P-P} , 75Ω)	16-CH composite video input: (NTSC/PAL) BNC (1.0V _{P-P} , 75Ω)
	Video Output	1-ch PAL/NTSC, BNC (1.0V _{P-P} , 75Ω) composite video signal output. 1-ch VGA output. 1-ch HDMI output. 1-ch matrix output. Support TV/VGA/HDMI video output at the same time.		
	Video Standard	PAL (625 line, 50f/s), NTSC (525 line, 60f/s)		
	Record Speed	Real-time Mode: PAL 1f/s to 25f/s per channel and NTSC 1f/s to 30f/s per channel		
	Video Partition	1/4 windows(Optional)	1/4/8/9 windows	1/4/8/9 /16 windows
	Monitor Touring	Support monitor tour functions such as alarm, motion detection, and schedule auto control.		

	Resolution (PAL/NTSC)	PAL/NTSC Real-time monitor: D1 704×576/704×480		
		Playback: 1/16-ch: D1 704×576/704×480 , CIF 352×288/ 352×240 , QCIF 176×144/176×120		
		Support dual streams: extra stream resolution CIF 352×288/ 352×240, QCIF 176×144/176×120.		
	Image Quality	6-level image quality (Adjustable)		
	Privacy mask	Support one privacy mask of user-defined size in full screen. Support max 4 zones.		
	Image Information	Channel information, time information and privacy mask zone.		
	TV Adjust	Adjust TV output zone suitable to anamorphic video.		
	Channel Lock	Cover secret channel with black screen though system is encoding normally. Screen-lock function to prevent unauthorized user seeing secret video.		
	Channel Information	Channel name, recording status, screen lock status, video loss status and motion detection status are shown on the bottom left of display screen.		
Color Configuration	Hue, brightness, contrast, saturation and gain setup for each channel.			
Audio	Audio Input	4-ch 200-2000mv 10KΩ(BNC)	4-ch 200-2000mv 10KΩ(BNC)	4-ch 200-2000mv 10KΩ(BNC)
	Audio Output	1-ch audio output 200-3000mv 5KΩ(BNC)		
	Bidirectional Audio	1-ch audio talk input 200-3000mv 10KΩ (BNC) 1-ch audio talk output 200-3000mv 5KΩ (BNC)		
Hard disk	Hard Disk	4 built-in SATA port. Support 4 HDDs.		
	Hard Disk Occupation	Audio: PCM 28.8MByte/h Video: 56-900MByte/h		
Record and playback	Recording Mode	Manual recording, motion detection recording, schedule recording and alarm recording Priority: Manual recording> alarm recording>motion detection recording>schedule recording.		
	Recording Length	1 to 120 minutes single record duration (Default setup is 60 minutes)		
	Playback Repeat Way	When hard disk is full, system can overwrite previous video file.		
	Record Search	Various search engines such as time, type and channel.		
	Playback Mode	Various fast play, slow play speeds, manual frame by frame playback and reverse play mode.		
	Various File Switch Ways	Can switch to previous or next file or any file in current play list. Can switch to file on other channel of the same time. (If there is a file) Support file continuous play, when a file is end system auto plays the next file in the current channel		
	Multi-channel Playback	There is 1/4/9/16-channel playback mode. (It may vary due to different series.)		
Window Zoom	Switch between self-adaptive screen/full screen when playback			

	Partial Enlargement	When in one-window full-screen playback mode, you can select any zone to activate partial enlargement function.			
Backup function	Backup Mode	HDD backup			
		Support peripheral USB backup device. (Flash disk, portable disk, USB burner and etc.)			
		Support peripheral eSATA backup device.			
		Support network download and backup			
Network Function	Network control	View monitor channel remotely.			
		DVR configuration through client-end and web browser			
		Upgrade via client or browser to realize remote maintenance.			
		View alarm information such as external alarm, motion detection and video loss via client.			
		Support network PTZ lens control			
		File download backup and playback			
		Multiple devices share information via corresponding software such as professional surveillance software (PSS)			
		Duplex transparent COM			
		Network alarm input and output			
Motion Detection and Alarm	Motion Detection	Zone setup: support 396/330((PAL 22×18, NTSC 22×15)) detection zones. Various sensitivity levels. Alarm can activate record or external alarm or screen message prompt.			
	Video Loss	Alarm can activate external alarm or screen message prompt.			
	External Alarm	Support record activation function or activate external alarm or screen message in specified period.			
	Manual Alarm Control	Enable or disable alarm input channel Support analog alarm signal to specific alarm output channel.			
	Alarm Input	4-ch alarm input (You can set normal open or normal close type to select the alarm type.)	8-ch alarm input (You can set normal open or normal close type to select the alarm type.)	16-ch alarm input (You can set normal open or normal close type to select the alarm type.)	
		Alarm Output	6-channel relay output, including one controllable DC +12V output port.		
	Alarm Relay	30V DC 2A, 125V AC 1A (activation alarm)			
	Interface	USB Interface	2 USB 2.0 ports.		
Network connection		RJ45 10M/100M/1000M self-adaptable Ethernet port			
RS485		PTZ control port Support various PTZ control protocols.			
RS232		Ordinary COM (Debug), keyboard connection and transparent serial port(COM input and output via network)			
System Information	Hard Disk Information	Display HDD current status			
	Data Stream Statistics	Data stream statistics for each channel (in wave mode)			
	Log statistics	Backup to 1024 log files. Support various search engines such as time and type.			
	Version	Display version information: channel amount, alarm input and output amount, system version and release date.			
	On-line user	Display current on-line user			

User Management	User Management	Multi-level user management; various management modes Integrated management for local user, serial port user and network user. Configurable user power.
		Support user /group and its corresponding rights modification. No limit to the user or group amount.
	Password Authentication	Password modification Administrator can modify other user's password. Account lock strategy Five times login failure in thirty minutes may result in account lock.
Upgrade		Web browser, client-end and update tool.
Login, Logout and Shutdown		Password login protection to guarantee safety
		User-friendly interface when login. Provide the following options: Logout /shutdown/ restart.
		Right authentication when shut down to make sure only those proper people can turn off DVR
General Parameter	Power	AC90~264V 50+2% Hz (Max 75W)
	Power Consumption	25W (Exclude HDD)
	Working Temperature	0°C – +55°C
	Working Humidity	10% – 90%
	Air Pressure	86kpa – 106kpa
	Dimension	1.5U standard industrial case. 440(W) x410 (D) x70mm(H)
	Weight	4.5-5.5KG(Exclude HDD)
	Installation Mode	Desktop/rack installation

1.3.4 HD-SDI 1080P 1.5U Series

	Parameter	4-ch	8-ch	16-ch
System	Main Processor	High-performance industrial embedded micro controller		
	OS	Embedded LINUX		
	System Resources	Multiplex operations: Multiple-channel record, multiple-channel playback and network operation simultaneously		
	Interface	User-friendly graphical user interface		
	Input Devices	Front panel, USB mouse		
	Input Method	Arabic number, English character, donation and extension Chinese (optional)		
	Shortcut Function	Copy/paste operation, USB mouse right-key shortcut menu, double click USB mouse to switch screen.		
Compression Standard	Video Compression	H.264		
	Audio Compression	G.711A		
	Video Input	4-CH HD-SDI video input: (NTSC/PAL) BNC (0.8VP-P, 75Ω)	8-CH HD-SDI video input: (NTSC/PAL) BNC (0.8VP-P, 75Ω)	16-CH HD-SDI video input: (NTSC/PAL) BNC (0.8VP-P, 75Ω)

Video monitor	Video Output	1-ch PAL/NTSC, BNC (1.0VP- P, 75Ω) composite video signal output. 1-ch VGA output. 1-ch HDMI output. Support TV/VGA/HDMI video output at the same time.		
	Video Standard	720P/25, 720P/30, 720P/50, 720P/60, 1080P/25, 1080P/30, 1080i/50、1080i/60		
	Record Speed	Real-time Mode: PAL 1f/s to 25f/s per channel and NTSC 1f/s to 30f/s per channel		In non real-time mode: when the resolution of the main stream is 1080P, the 1/5/9/13-channel max supports 25f/s or 30f/s and the resolution of the rest channels support 12f/s or 15f/s.
	Video Partition	1/4 windows	1/4/8/9 windows	1/4/8/9/16 windows
	Monitor Touring	Support monitor tour functions such as alarm, motion detection, and schedule auto control.		
	Resolution (PAL/NTSC)	PAL(50f/s), NTSC(60f/s) Real time 1080P(1920*1080) Recording playback 1/4- channel: 1080P 1920*1080 720P 1280*720 D1 704*576/704*480 ; CIF 352*288/ 352*240; QCIF 176*144/176*120 Dual-stream supported: Extra stream resolution: D1 704*576/704*480 ;CIF 352*288/ 352*240 ; QCIF 176*144/176*120		
	Image Quality	6-level image quality (Adjustable)		
	Privacy mask	Support one privacy mask of user-defined size in full screen. Support max 4 zones.		
	Image Information	Channel information, time information and privacy mask zone.		
	TV Adjust	Adjust TV output zone suitable to anamorphic video.		
	Channel Lock	Cover secret channel with black screen though system is encoding normally. Screen-lock function to prevent unauthorized user seeing secret video.		
	Channel Information	Channel name, recording status, screen lock status, video loss status and motion detection status are shown on the bottom left of display screen.		
	Audio	Audio Input	4-ch 200-2000mv 10KΩ(BNC)	8-ch 200-2000mv 10KΩ(BNC)
Audio Output		1-ch audio output 200-3000mv 5KΩ(BNC)		
Bidirectional Audio		1-ch audio talk input 200-3000mv 10KΩ (BNC) 1-ch audio talk output 200-3000mv 5KΩ (BNC)		
Hard disk	Hard Disk	4 built-in SATA ports. Support 4 HDDs.		
	Hard Disk Occupation	Audio: PCM 28.8MByte/h Video: 56-3600MByte/h		
Record and playback	Recording Mode	Manual recording, motion detection recording, schedule recording and alarm recording Priority: Manual recording> alarm recording>motion detection recording>schedule recording.		
	Recording Length	1 to 120 minutes single record duration (Default setup is 60 minutes)		

	Playback Repeat Way	When hard disk is full, system can overwrite previous video file.		
	Record Search	Various search engines such as time, type and channel.		
	Playback Mode	Various fast play, slow play speeds, manual frame by frame playback and reverse play mode.		
	Various File Switch Ways	Can switch to previous or next file or any file in current play list. Can switch to file on other channel of the same time. (If there is a file) Support file continuous play, when a file is end system auto plays the next file in the current channel		
	Multi-channel Playback	There is 1/4-channel playback mode.	There is 1/4-channel playback mode.	There is 1/4-channel playback mode.
	Window Zoom	Switch between self-adaptive screen/full screen when playback		
	Partial Enlargement	When in one-window full-screen playback mode, you can select any zone to activate partial enlargement function.		
Backup function	Backup Mode	HDD backup		
		Support peripheral USB backup device. (Flash disk, portable disk, USB burner and etc.)		
		Support peripheral eSATA backup device.		
		Support network download and backup		
Network Function	Network control	View monitor channel remotely.		
		DVR configuration through client-end and web browser		
		Upgrade via client or browser to realize remote maintenance.		
		View alarm information such as external alarm, motion detection and video loss via client.		
		Support network PTZ lens control		
		File download backup and playback		
		Multiple devices share information via corresponding software such as professional surveillance software (PSS)		
		Duplex transparent COM		
		Network alarm input and output		
Motion Detection and Alarm	Motion Detection	Zone setup: support 396/330((PAL 22×18, NTSC 22×15)) detection zones. Various sensitivity levels. Alarm can activate record or external alarm or screen message prompt.		
	Video Loss	Alarm can activate external alarm or screen message prompt.		
	External Alarm	Support record activation function or activate external alarm or screen message in specified period.		
	Manual Alarm Control	Enable or disable alarm input channel Support analog alarm signal to specific alarm output channel.		
	Alarm Input	4-ch alarm input (You can set normal open or normal close type to select the alarm type.)	8-ch alarm input (You can set normal open or normal close type to select the alarm type.)	16-ch alarm input (You can set normal open or normal close type to select the alarm type.)
	Alarm Output	6-channel relay output, including one controllable DC +12V output port.		
	Alarm Relay	30V DC 2A, 125V AC 1A (activation alarm)		
Interface	USB Interface	3 USB 2.0 ports.		
	Network connection	RJ45 10M/100M/1000M self-adaptable Ethernet port		

	RS485	Two RS485 ports. PTZ control port Support various PTZ control protocols.
	RS232	Ordinary COM (Debug), keyboard connection and transparent serial port (COM input and output via network)
System Information	Hard Disk Information	Display HDD current status
	Data Stream Statistics	Data stream statistics for each channel (in wave mode)
	Log statistics	Backup to 1024 log files. Support various search engines such as time and type.
	Version	Display version information: channel amount, alarm input and output amount, system version and release date.
	On-line user	Display current on-line user
User Management	User Management	Multi-level user management; various management modes Integrated management for local user, serial port user and network user. Configurable user power.
		Support user /group and its corresponding rights modification. No limit to the user or group amount.
	Password Authentication	Password modification Administrator can modify other user's password. Account lock strategy Five times login failure in thirty minutes may result in account lock.
Upgrade		Web browser, client-end and update tool.
Login, Logout and Shutdown		Password login protection to guarantee safety
		User-friendly interface when login. Provide the following options: Logout /shutdown/ restart.
		Right authentication when shut down to make sure only those proper people can turn off DVR
General Parameter	Power	AC90~264V 50+2% Hz (Max 220W)
	Power Consumption	40W (Exclude HDD)
	Working Temperature	0°C – +55°C
	Working Humidity	10% – 90%
	Air Pressure	86kpa – 106kpa
	Dimension	1.5U standard industrial case. 440(W) x410 (D) x70mm(H)
	Weight	4.5 – 5.5KG (Exclude HDD)
	Installation Mode	Desktop/rack installation

1.3.5 Simple 1.5 U Series

	Parameter	4-ch	8-ch	16-ch
System	Main Processor	High-performance industrial embedded micro controller		
	OS	Embedded LINUX		
	System Resources	Multiplex operations: Multiple-channel record, multiple-channel playback and network operation simultaneously		
	Interface	User-friendly graphical user interface		
	Input Devices	Front panel, USB mouse		

	Input Method	Arabic number, English character, donation and extension Chinese (optional)		
	Shortcut Function	Copy/paste operation, USB mouse right-key shortcut menu, double click USB mouse to switch screen.		
Compression Standard	Video Compression	H.264		
	Audio Compression	G.711A		
Video monitor	Video Input	4-CH composite video input: (NTSC/PAL) BNC (1.0V _{P-P} , 75Ω)	8-CH composite video input: (NTSC/PAL) BNC (1.0V _{P-P} , 75Ω)	16-CH composite video input: (NTSC/PAL) BNC (1.0V _{P-P} , 75Ω)
	Video Output	1-ch PAL/NTSC, BNC (1.0V _{P-P} , 75Ω) composite video signal output. 1-ch VGA output. 1-ch HDMI output. 1-ch matrix output. Support TV/VGA/HDMI video output at the same time.		
	Video Standard	PAL (625 line, 50f/s), NTSC (525 line, 60f/s)		
	Record Speed	Real-time Mode: PAL 1f/s to 25f/s per channel and NTSC 1f/s to 30f/s per channel		
	Video Partition	1/4 windows(Optional)	1/4/8/9 windows	1/4/8/9 /16 windows
	Monitor Touring	Support monitor tour functions such as alarm, motion detection, and schedule auto control.		
	Resolution (PAL/NTSC)	PAL/NTSC Real-time monitor: D1 704×576/704×480		
		Playback channel 1/16: D1 704×576/704×480 ; HD1 704×288/704×240; 2CIF 352×576/352×480; CIF 352×288/ 352×240; QCIF 176×144/176×120		
		Support dual streams. Extra stream resolution: CIF 352×288/ 352×240 QCIF 176×144/176×120		
	Image Quality	6-level image quality (Adjustable)		
	Privacy mask	Support one privacy mask of user-defined size in full screen. Support max 4 zones.		
	Image Information	Channel information, time information and privacy mask zone.		
	TV Adjust	Adjust TV output zone suitable to anamorphic video.		
Channel Lock	Cover secret channel with black screen though system is encoding normally. Screen-lock function to prevent unauthorized user seeing secret video.			
Channel Information	Channel name, recording status, screen lock status, video loss status and motion detection status are shown on the bottom left of display screen.			
Color Configuration	Hue, brightness, contrast, saturation and gain setup for each channel.			

Audio	Audio Input	4-ch 200-2000mv 10KΩ(BNC)	8-ch 200-2000mv 10KΩ(BNC)	4-ch 200-2000mv 10KΩ (RCA)
	Audio Output	1-ch audio output 200-3000mv 5KΩ(BNC)		1-ch audio output 200-3000mv 5KΩ(RCA)
	Bidirectional Audio	1-ch audio talk output 200-3000mv 5KΩ(BNC)		1-ch audio output 200-3000mv 5KΩ(RCA)
Hard disk	Hard Disk	2 built-in SATA port. Support 2 HDDs.		
	Hard Disk Occupation	Audio: PCM 28.8MByte/h Video: 56-900MByte/h		
Record and playback	Recording Mode	Manual recording, motion detection recording, schedule recording and alarm recording Priority: Manual recording> alarm recording>motion detection recording>schedule recording.		
	Recording Length	1 to 120 minutes single record duration (Default setup is 60 minutes)		
	Playback Repeat Way	When hard disk is full, system can overwrite previous video file.		
	Record Search	Various search engines such as time, type and channel.		
	Playback Mode	Various fast play, slow play speeds, manual frame by frame playback and reverse play mode.		
	Various File Switch Ways	Can switch to previous or next file or any file in current play list. Can switch to file on other channel of the same time. (If there is a file) Support file continuous play, when a file is end system auto plays the next file in the current channel		
	Multi-channel Playback	There is 1/4/9/16-channel playback mode. (It may vary due to different series.)		
	Window Zoom	Switch between self-adaptive screen/full screen when playback		
	Partial Enlargement	When in one-window full-screen playback mode, you can select any zone to activate partial enlargement function.		
Backup function	Backup Mode	HDD backup		
		Support peripheral USB backup device. (Flash disk, portable disk, USB burner and etc.)		
		Support peripheral eSATA backup device.		
		Support network download and backup		
Network Function	Network control	View monitor channel remotely.		
		DVR configuration through client-end and web browser		
		Upgrade via client or browser to realize remote maintenance.		
		View alarm information such as external alarm, motion detection and video loss via client.		
		Support network PTZ lens control		
		File download backup and playback		
		Multiple devices share information via corresponding software such as professional surveillance software (PSS)		
		Duplex transparent COM		
		Network alarm input and output		
		Bidirectional audio.		
Motion Detection and Alarm	Motion Detection	Zone setup: support 396/330((PAL 22×18, NTSC 22×15)) detection zones. Various sensitivity levels. Alarm can activate record or external alarm or screen message prompt.		

	Video Loss	Alarm can activate external alarm or screen message prompt.		
	External Alarm	Support record activation function or activate external alarm or screen message in specified period.		
	Manual Alarm Control	Enable or disable alarm input channel Support analog alarm signal to specific alarm output channel.		
	Alarm Input	4-ch alarm input (You can set normal open or normal close type to select the alarm type.)	8-ch alarm input (You can set normal open or normal close type to select the alarm type.)	16-ch alarm input (You can set normal open or normal close type to select the alarm type.)
	Alarm Output	3-channel relay output (The upper limit for rated current is 800mA)		
	Alarm Relay	30V DC 2A, 125V AC 1A (activation alarm)		
Interface	USB Interface	2 USB 2.0 ports.		
	Network connection	RJ45 10M/100M/1000M self-adaptable Ethernet port		
	RS485	PTZ control port Support various PTZ control protocols.		
	RS232	Ordinary COM (Debug), keyboard connection and transparent serial port(COM input and output via network)		
System Information	Hard Disk Information	Display HDD current status		
	Data Stream Statistics	Data stream statistics for each channel (in wave mode)		
	Log statistics	Backup to 1024 log files. Support various search engines such as time and type.		
	Version	Display version information: channel amount, alarm input and output amount, system version and release date.		
	On-line user	Display current on-line user		
User Management	User Management	Multi-lever user management; various management modes Integrated management for local user, serial port user and network user. Configurable user power.		
		Support user /group and its corresponding rights modification. No limit to the user or group amount.		
	Password Authentication	Password modification Administrator can modify other user's password. Account lock strategy Five times login failure in thirty minutes may result in account lock.		
Upgrade		Web browser, client-end and update tool.		
Login, Logout and Shutdown		Password login protection to guarantee safety		
		User-friendly interface when login. Provide the following options: Logout /shutdown/ restart.		
		Right authentication when shut down to make sure only those proper people can turn off DVR		
General Parameter	Power	DC 12V		
	Power Consumption	≤25W (Include adapter; Exclude HDD)		
	Working Temperature	0°C – +55°C		
	Working Humidity	10% – 90%		

	Air Pressure	86kpa – 106kpa
	Dimension	1.5U standard industrial case. 440(W) x410 (D) x70mm(H)
	Weight	3.9 – 4.5KG (Exclude HDD)
	Installation Mode	Desktop

1.3.6 960H 4HDD 1.5U Series

	Parameter	4-ch	8-ch	16-ch
System	Main Processor	High-performance industrial embedded micro controller		
	OS	Embedded LINUX		
	System Resources	Multiplex operations: Multiple-channel record, multiple-channel playback and network operation simultaneously		
	Interface	User-friendly graphical user interface		
	Input Devices	Front panel, USB mouse, remote control		
	Input Method	Arabic number, English character, donation and extension Chinese (optional)		
	Shortcut Function	Copy/paste operation, USB mouse right-key shortcut menu, double click USB mouse to switch screen.		
Compression Standard	Video Compression	H.264		
	Audio Compression	G711A, G711U, PCM		
Video monitor	Video Input	4-CH composite video input: (NTSC/PAL) BNC (1.0V _{P-P} , 75Ω)	8-CH composite video input: (NTSC/PAL) BNC (1.0V _{P-P} , 75Ω)	16-CH composite video input: (NTSC/PAL) BNC (1.0V _{P-P} , 75Ω)
	Video Output	1-ch PAL/NTSC, BNC (1.0V _{P-P} , 75Ω) composite video signal output. 1-ch VGA output. 1-ch HDMI output. 1-ch matrix output. Support TV/VGA/HDMI video output at the same time.		
	Video Standard	PAL (625 line, 50f/s), NTSC (525 line, 60f/s)		
	Record Speed	Real-time Mode: PAL 1f/s to 25f/s per channel and NTSC 1f/s to 30f/s per channel		
	Video Partition	1/4 windows(Optional)	1/4/8/9 windows	1/4/8/9 /16 windows
	Monitor Touring	Support monitor tour functions such as alarm, motion detection, and schedule auto control.		
	Resolution (PAL/NTSC)	PAL(625TVL, 50f/s)/NTSC(525TVL, 60f/s) Real-time monitor: 960H 960 ×576/960×480		
		Playback channel 1/16: 960 ×576/960×480 D1 704×576/704×480 、 CIF 352×288/ 352×240 、 QCIF 176×144/176×120		
		Support dual streams. Extra stream resolution: CIF 352×288/ 352×240 QCIF 176×144/176×120		
Image Quality	6-level image quality (Adjustable)			

	Privacy mask	Support one privacy mask of user-defined size in full screen. Support max 4 zones.		
	Image Information	Channel information, time information and privacy mask zone.		
	TV Adjust	Adjust TV output zone suitable to anamorphic video.		
	Channel Lock	Cover secret channel with black screen though system is encoding normally. Screen-lock function to prevent unauthorized user seeing secret video.		
	Channel Information	Channel name, recording status, screen lock status, video loss status and motion detection status are shown on the bottom left of display screen.		
	Color Configuration	Hue, brightness, contrast, saturation and gain setup for each channel.		
Audio	Audio Input	4-ch 200-2000mv 10KΩ(BNC)	4-ch 200-2000mv 10KΩ(BNC)	4-ch 200-2000mv 10KΩ (BNC)
	Audio Output	1-ch audio output 200-3000mv 5KΩ(BNC)		
	Bidirectional Audio	1-ch audio talk input 200-3000mv 10KΩ (BNC) 1-ch audio talk output 200-3000mv 5KΩ (BNC)		
Hard disk	Hard Disk	4 built-in SATA port. Support 4 HDDs.		
	Hard Disk Occupation	Audio: PCM 28.8MByte/h Video: 56-900MByte/h		
Record and playback	Recording Mode	Manual recording, motion detection recording, schedule recording and alarm recording Priority: Manual recording> alarm recording>motion detection recording>schedule recording.		
	Recording Length	1 to 120 minutes single record duration (Default setup is 60 minutes)		
	Playback Repeat Way	When hard disk is full, system can overwrite previous video file.		
	Record Search	Various search engines such as time, type and channel.		
	Playback Mode	Various fast play, slow play speeds, manual frame by frame playback and reverse play mode.		
	Various File Switch Ways	Can switch to previous or next file or any file in current play list. Can switch to file on other channel of the same time. (If there is a file) Support file continuous play, when a file is end system auto plays the next file in the current channel		
	Multi-channel Playback	There is 1/4/9/16-channel playback mode. (It may vary due to different series.)		
	Window Zoom	Switch between self-adaptive screen/full screen when playback		
	Partial Enlargement	When in one-window full-screen playback mode, you can select any zone to activate partial enlargement function.		
Backup function	Backup Mode	HDD backup		
		Support peripheral USB backup device. (Flash disk, portable disk, USB burner and etc.)		
		Support peripheral eSATA backup device.		
		Support network download and backup		
Network Function	Network control	View monitor channel remotely.		
		DVR configuration through client-end and web browser		
		Upgrade via client or browser to realize remote maintenance.		
		View alarm information such as external alarm, motion detection and video loss via client.		

		Support network PTZ lens control		
		File download backup and playback		
		Multiple devices share information via corresponding software such as professional surveillance software (PSS)		
		Duplex transparent COM		
		Network alarm input and output		
		Bidirectional audio.		
		Support dual network cards mode such as multiple-address mode, fault-tolerance, and load balance.		
Motion Detection and Alarm	Motion Detection	Zone setup: support 396/330((PAL 22×18, NTSC 22×15)) detection zones. Various sensitivity levels. Alarm can activate record or external alarm or screen message prompt.		
	Video Loss	Alarm can activate external alarm or screen message prompt.		
	External Alarm	Support record activation function or activate external alarm or screen message in specified period.		
	Manual Alarm Control	Enable or disable alarm input channel Support analog alarm signal to specific alarm output channel.		
	Alarm Input	4-ch alarm input (You can set normal open or normal close type to select the alarm type.)	8-ch alarm input (You can set normal open or normal close type to select the alarm type.)	16-ch alarm input (You can set normal open or normal close type to select the alarm type.)
	Alarm Output	6-channel relay output, including one controllable DC +12V output port.		
	Alarm Relay	30V DC 2A, 125V AC 1A (activation alarm)		
Interface	USB Interface	4 USB 2.0 ports.		
	Network connection	2 RJ45 10M/100M/1000M self-adaptable Ethernet port		
	RS485	PTZ control port Support various PTZ control protocols.		
	RS232	Ordinary COM (Debug),keyboard connection and transparent serial port(COM input and output via network)		
System Information	Hard Disk Information	Display HDD current status		
	Data Stream Statistics	Data stream statistics for each channel (in wave mode)		
	Log statistics	Backup to 1024 log files. Support various search engines such as time and type.		
	Version	Display version information: channel amount, alarm input and output amount, system version and release date.		
	On-line user	Display current on-line user		
User Management	User Management	Multi-lever user management; various management modes Integrated management for local user, serial port user and network user. Configurable user power.		
		Support user /group and its corresponding rights modification. No limit to the user or group amount.		
	Password Authentication	Password modification Administrator can modify other user's password.		
		Account lock strategy Five times login failure in thirty minutes may result in account lock.		
Upgrade		Web browser, client-end and update tool.		
Login, Logout and Shutdown		Password login protection to guarantee safety		

		User-friendly interface when login. Provide the following options: Logout /shutdown/ restart.
		Right authentication when shut down to make sure only those proper people can turn off DVR
General Parameter	Power	AC90~264V 50+2% Hz (Max 220W)
	Power Consumption	25W (Exclude HDD)
	Working Temperature	0°C – +55°C
	Working Humidity	10% – 90%
	Air Pressure	86kpa – 106kpa
	Dimension	1.5U standard industrial case. 440(W) x410 (D) x70mm(H)
	Weight	4.5-5.5KG(Exclude HDD)
	Installation Mode	Desktop/rack installation

1.3.7 960H 2HDD 1.5U Series

	Parameter	4-ch	8-ch	16-ch
System	Main Processor	High-performance industrial embedded micro controller		
	OS	Embedded LINUX		
	System Resources	Multiplex operations: Multiple-channel record, multiple-channel playback and network operation simultaneously		
	Interface	User-friendly graphical user interface		
	Input Devices	Front panel, USB mouse, remote control		
	Input Method	Arabic number, English character, donation and extension Chinese (optional)		
	Shortcut Function	Copy/paste operation, USB mouse right-key shortcut menu, double click USB mouse to switch screen.		
Compression Standard	Video Compression	H.264		
	Audio Compression	G711A, G711U, PCM		
Video monitor	Video Input	4-CH composite video input: (NTSC/PAL) BNC (1.0V _{P-P} , 75Ω)	8-CH composite video input: (NTSC/PAL) BNC (1.0V _{P-P} , 75Ω)	16-CH composite video input: (NTSC/PAL) BNC (1.0V _{P-P} , 75Ω)
	Video Output	1-ch PAL/NTSC, BNC (1.0V _{P-P} , 75Ω) composite video signal output. 1-ch VGA output. 1-ch HDMI output. 1-ch matrix output. Support TV/VGA/HDMI video output at the same time.		
	Video Standard	PAL (625 line, 50f/s), NTSC (525 line, 60f/s)		
	Record Speed	Real-time Mode: PAL 1f/s to 25f/s per channel and NTSC 1f/s to 30f/s per channel		
	Video Partition	1/4 windows(Optional)	1/4/8/9 windows	1/4/8/9 /16 windows
	Monitor Touring	Support monitor tour functions such as alarm, motion detection, and schedule auto control.		
	Resolution (PAL/NTSC)	PAL(625TVL, 50f/s)/NTSC(525TVL, 60f/s) Real-time monitor: 960H 960 ×576/960×480		

		Playback channel 1/16: 960 ×576/960×480 D1 704×576/704×480, CIF 352×288/ 352×240, QCIF 176×144/176×120		
		Support dual streams. Extra stream resolution: CIF 352×288/ 352×240 QCIF 176×144/176×120		
	Image Quality	6-level image quality (Adjustable)		
	Privacy mask	Support one privacy mask of user-defined size in full screen. Support max 4 zones.		
	Image Information	Channel information, time information and privacy mask zone.		
	TV Adjust	Adjust TV output zone suitable to anamorphic video.		
	Channel Lock	Cover secret channel with black screen though system is encoding normally. Screen-lock function to prevent unauthorized user seeing secret video.		
	Channel Information	Channel name, recording status, screen lock status, video loss status and motion detection status are shown on the bottom left of display screen.		
Color Configuration	Hue, brightness, contrast, saturation and gain setup for each channel.			
Audio	Audio Input	4-ch 200-2000mv 10KΩ(RCA)	8-ch 200-2000mv 10KΩ(RCA)	4-ch 200- 2000mv 10KΩ (RCA)
	Audio Output	1-ch audio output 200-3000mv 5KΩ(RCA)		
	Bidirectional Audio	1-ch audio talk input 200-3000mv 10KΩ (RCA) 1-ch audio talk output 200-3000mv 5KΩ (RCA)		
Hard disk	Hard Disk	2 built-in SATA port. Support 2 HDDs.		
	Hard Disk Occupation	Audio: PCM 28.8MByte/h Video: 56-900MByte/h		
Record and playback	Recording Mode	Manual recording, motion detection recording, schedule recording and alarm recording Priority: Manual recording> alarm recording>motion detection recording>schedule recording.		
	Recording Length	1 to 120 minutes single record duration (Default setup is 60 minutes)		
	Playback Repeat Way	When hard disk is full, system can overwrite previous video file.		
	Record Search	Various search engines such as time, type and channel.		
	Playback Mode	Various fast play, slow play speeds, manual frame by frame playback and reverse play mode.		
	Various File Switch Ways	Can switch to previous or next file or any file in current play list. Can switch to file on other channel of the same time. (If there is a file) Support file continuous play, when a file is end system auto plays the next file in the current channel		
	Multi-channel Playback	There is 1/4/9/16-channel playback mode. (It may vary due to different series.)		
	Window Zoom	Switch between self-adaptive screen/full screen when playback		
Partial Enlargement	When in one-window full-screen playback mode, you can select any zone to activate partial enlargement function.			
Backup	Backup Mode	HDD backup		

function		Support peripheral USB backup device. (Flash disk, portable disk, USB burner and etc.)		
		Support peripheral eSATA backup device.		
		Support network download and backup		
Network Function	Network control	View monitor channel remotely.		
		DVR configuration through client-end and web browser		
		Upgrade via client or browser to realize remote maintenance.		
		View alarm information such as external alarm, motion detection and video loss via client.		
		Support network PTZ lens control		
		File download backup and playback		
		Multiple devices share information via corresponding software such as professional surveillance software (PSS)		
		Duplex transparent COM		
		Network alarm input and output		
		Bidirectional audio.		
		Support dual network cards mode such as multiple-address mode, fault-tolerance, and load balance.		
Motion Detection and Alarm	Motion Detection	Zone setup: support 396/330((PAL 22×18, NTSC 22×15)) detection zones. Various sensitivity levels. Alarm can activate record or external alarm or screen message prompt.		
	Video Loss	Alarm can activate external alarm or screen message prompt.		
	External Alarm	Support record activation function or activate external alarm or screen message in specified period.		
	Manual Alarm Control	Enable or disable alarm input channel Support analog alarm signal to specific alarm output channel.		
	Alarm Input	4-ch alarm input (You can set normal open or normal close type to select the alarm type.)	8-ch alarm input (You can set normal open or normal close type to select the alarm type.)	16-ch alarm input (You can set normal open or normal close type to select the alarm type.)
	Alarm Output	3-channel relay output, including one controllable DC +12V output port.		
	Alarm Relay	30V DC 2A, 125V AC 1A (activation alarm)		
Interface	USB Interface	2 USB 2.0 ports.		
	Network connection	1 RJ45 10M/100M/1000M self-adaptable Ethernet port		
	RS485	PTZ control port Support various PTZ control protocols.		
	RS232	Ordinary COM (Debug),keyboard connection and transparent serial port(COM input and output via network)		
System Information	Hard Disk Information	Display HDD current status		
	Data Stream Statistics	Data stream statistics for each channel (in wave mode)		
	Log statistics	Backup to 1024 log files. Support various search engines such as time and type.		
	Version	Display version information: channel amount, alarm input and output amount, system version and release date.		
	On-line user	Display current on-line user		
User Management	User Management	Multi-lever user management; various management modes Integrated management for local user, serial port user and network user. Configurable user power.		

		Support user /group and its corresponding rights modification. No limit to the user or group amount.
	Password Authentication	Password modification Administrator can modify other user's password. Account lock strategy Five times login failure in thirty minutes may result in account lock.
Upgrade		Web browser, client-end and update tool.
Login, Logout and Shutdown		Password login protection to guarantee safety User-friendly interface when login. Provide the following options: Logout /shutdown/ restart. Right authentication when shut down to make sure only those proper people can turn off DVR
General Parameter	Power	DC 12V
	Power Consumption	≤25W (With adapter, exclude HDD)
	Working Temperature	0°C – +55°C
	Working Humidity	10% – 90%
	Air Pressure	86kpa – 106kpa
	Dimension	1.5U standard industrial case. 440(W) x410 (D) x70mm(H)
	Weight	4.5-5.5KG(Exclude HDD)
	Installation Mode	Desktop/rack installation

1.3.8 General 2U Series

	Parameter	4-ch	8-ch	16-ch	24-ch	32-ch
System	Main Processor	High-performance industrial embedded micro controller				
	OS	Embedded LINUX				
	System Resources	Multiplex operations: Multiple-channel record, multiple-channel playback and network operation simultaneously				
	Interface	User-friendly graphical user interface				
	Input Devices	Front panel, USB mouse				
	Input Method	Arabic number, English character, donation and extension Chinese (optional)				
	Shortcut Function	Copy/paste operation, USB mouse right-key shortcut menu, double click USB mouse to switch screen.				
Compression Standard	Video Compression	H.264				
	Audio Compression	G.711A				
Video monitor	Video Input	4-CH composite video input: (NTSC/PAL) BNC (1.0V _{P-P} , 75Ω)	8-CH composite video input: (NTSC/PAL) BNC (1.0V _{P-P} , 75Ω)	16-CH composite video input: (NTSC/PAL) BNC (1.0V _{P-P} , 75Ω)	24H composite video input: (NTSC/PAL) BNC (1.0V _{P-P} , 75Ω)	32H composite video input: (NTSC/PAL) BNC (1.0V _{P-P} , 75Ω)

	Video Output	1-ch PAL/NTSC, BNC (1.0VP- P, 75Ω) composite video signal output. 1-ch VGA output. 1-ch HDMI output. 1-ch matrix output. Support TV/VGA/HDMI video output at the same time.				
	Video Standard	PAL (625 line, 50f/s), NTSC (525 line, 60f/s)				
	Record Speed	Real-time Mode: PAL 1f/s to 25f/s per channel and NTSC 1f/s to 30f/s per channel				
	Video Partition	1/4 windows(Optional)	1/4/8/9 windows	1/4/8/9 /16 windows	1/4/8/9 /16/25 windows	1/4/8/9 /16/25/36 windows
	Monitor Touring	Support monitor tour functions such as alarm, motion detection, and schedule auto control.				
	Resolution (PAL/NTSC)	PAL/NTSC Real-time monitor: D1 704×576/704×480				
		Playback channel 1/16: D1 704×576/704×480 CIF 352×288/ 352×240 QCIF 176×144/176×120				
		Support dual streams. Extra stream resolution: CIF 352×288/ 352×240 QCIF 176×144/176×120				
	Image Quality	6-level image quality (Adjustable)				
	Privacy mask	Support one privacy mask of user-defined size in full screen. Support max 4 zones.				
	Image Information	Channel information, time information and privacy mask zone.				
	TV Adjust	Adjust TV output zone suitable to anamorphic video.				
	Channel Lock	Cover secret channel with black screen though system is encoding normally. Screen-lock function to prevent unauthorized user seeing secret video.				
	Channel Information	Channel name, recording status, screen lock status, video loss status and motion detection status are shown on the bottom left of display screen.				
	Color Configuration	Hue, brightness, contrast, saturation and gain setup for each channel.				
Audio	Audio Input	4-channel 200-2000mV 10KΩ (BNC)	8-channel 200-2000mV 10KΩ (BNC)	16-channel 200-2000mV 10KΩ (BNC)	16-channel 200-2000mV 10KΩ (BNC)	16-channel 200-2000mV 10KΩ (BNC)
	Audio Output	1-channel audio output 200-3000mv 5KΩ (BNC)				
	Bidirectional Audio	1-ch audio talk input 200-3000mv 10KΩ (BNC) 1-ch audio talk output 200-3000mv 5KΩ (BNC)				
Hard disk	Hard Disk	8 built-in SATA port. Support 8 HDDs.				
	Hard Disk Occupation	Audio: PCM 28.8MByte/h Video: 56-900MByte/h				
Record and	Recording Mode	Manual recording, motion detection recording, schedule recording and alarm recording Priority: Manual recording> alarm recording>motion detection recording>schedule recording.				

playback	Recording Length	1 to 120 minutes single record duration (Default setup is 60 minutes)				
	Playback Repeat Way	When hard disk is full, system can overwrite previous video file.				
	Record Search	Various search engines such as time, type and channel.				
	Playback Mode	Various fast play, slow play speeds, manual frame by frame playback and reverse play mode.				
	Various File Switch Ways	Can switch to previous or next file or any file in current play list. Can switch to file on other channel of the same time. (If there is a file) Support file continuous play, when a file is end system auto plays the next file in the current channel				
	Multi-channel Playback	There is 1/4/9/16-channel playback mode. (It may vary due to different series.)				
	Window Zoom	Switch between self-adaptive screen/full screen when playback				
	Partial Enlargement	When in one-window full-screen playback mode, you can select any zone to activate partial enlargement function.				
Backup function	Backup Mode	HDD backup				
		Support peripheral USB backup device. (Flash disk, portable disk, USB burner and etc.)				
		Support peripheral eSATA backup device.				
		Support network download and backup				
Network Function	Network control	View monitor channel remotely.				
		DVR configuration through client-end and web browser				
		Upgrade via client or browser to realize remote maintenance.				
		View alarm information such as external alarm, motion detection and video loss via client.				
		Support network PTZ lens control				
		File download backup and playback				
		Multiple devices share information via corresponding software such as professional surveillance software (PSS)				
		Duplex transparent COM				
		Network alarm input and output				
		Bidirectional audio.				
Motion Detection and Alarm	Motion Detection	Zone setup: support 396/330((PAL 22×18, NTSC 22×15)) detection zones. Various sensitivity levels. Alarm can activate record or external alarm or screen message prompt.				
	Video Loss	Alarm can activate external alarm or screen message prompt.				
	External Alarm	Support record activation function or activate external alarm or screen message in specified period.				
	Manual Alarm Control	Enable or disable alarm input channel Support analog alarm signal to specific alarm output channel.				
	Alarm Input	4-ch alarm input (You can set normal open or normal close type to select the alarm type.)	8-ch alarm input (You can set normal open or normal close type to select the alarm type.)	16-ch alarm input (You can set normal open or normal close type to select the alarm type.)	16-ch alarm input (You can set normal open or normal close type to select the alarm type.)	16-ch alarm input (You can set normal open or normal close type to select the alarm type.)

	Alarm Output	6-channel relay output, including one controllable DC +12V output port.	6-channel relay output, including one controllable DC +12V output port.	6-channel relay output, including one controllable DC +12V output port.	5-channel relay output., including one controllable DC +12V output port.	5-channel relay output, including one controllable DC +12V output port.
	Alarm Relay	30V DC 2A, 125V AC 1A (activation alarm)				
Interface	USB Interface	3 USB 2.0 ports.				
	Network connection	RJ45 10M/100M/1000M self-adaptable Ethernet port				
	RS485	PTZ control port Support various PTZ control protocols.				
	RS232	Ordinary COM (Debug), keyboard connection and transparent serial port (COM input and output via network)				
System Information	Hard Disk Information	Display HDD current status				
	Data Stream Statistics	Data stream statistics for each channel (in wave mode)				
	Log statistics	Backup to 1024 log files. Support various search engines such as time and type.				
	Version	Display version information: channel amount, alarm input and output amount, system version and release date.				
	On-line user	Display current on-line user				
User Management	User Management	Multi-lever user management; various management modes Integrated management for local user, serial port user and network user. Configurable user power.				
		Support user /group and its corresponding rights modification. No limit to the user or group amount.				
	Password Authentication	Password modification Administrator can modify other user's password.				
		Account lock strategy Five times login failure in thirty minutes may result in account lock.				
Upgrade		Web browser, client-end and update tool.				
Login, Logout and Shutdown		Password login protection to guarantee safety				
		User-friendly interface when login. Provide the following options: Logout /shutdown/ restart.				
		Right authentication when shut down to make sure only those proper people can turn off DVR				
General Parameter	Power	AC90~264V 50+2% Hz (Max 220W)				
	Power Consumption	25W (Exclude HDD)				
	Working Temperature	0°C – +55°C				
	Working Humidity	10% – 90%				
	Air Pressure	86kpa – 106kpa				
	Dimension	2U standard industrial case. 440(W) x460 (D) x89mm(H)				
	Weight	6.5-7.5KG(Exclude HDD)				
	Installation Mode	Desktop/rack installation				

1.3.9 HD-SDI 1080P 2U Series

	Parameter	4-ch	8-ch	16-ch
System	Main Processor	High-performance industrial embedded micro controller		
	OS	Embedded LINUX		
	System Resources	Multiplex operations: Multiple-channel record, multiple-channel playback and network operation simultaneously		
	Interface	User-friendly graphical user interface		
	Input Devices	Front panel, USB mouse		
	Input Method	Arabic number, English character, donation and extension Chinese (optional)		
	Shortcut Function	Copy/paste operation, USB mouse right-key shortcut menu, double click USB mouse to switch screen.		
Compression Standard	Video Compression	H.264		
	Audio Compression	G.711A		
Video monitor	Video Input	4-CH HD-SDI video input: (NTSC/PAL) BNC (0.8VP-P, 75Ω)	8-CH HD-SDI video input: (NTSC/PAL) BNC (0.8VP-P, 75Ω)	16-CH HD-SDI video input: (NTSC/PAL) BNC (0.8VP-P, 75Ω)
	Video Output	1-ch PAL/NTSC, BNC (1.0VP- P, 75Ω) composite video signal output. 1-ch VGA output. 1-ch HDMI output. Support TV/VGA/HDMI video output at the same time.		
	Video Standard	720P/25, 720P/30, 720P/50, 720P/60, 1080P/25, 1080P/30, 1080i/50、1080i/60		
	Record Speed	Real-time Mode: PAL 1f/s to 25f/s per channel and NTSC 1f/s to 30f/s per channel	Real-time Mode: PAL 1f/s to 25f/s per channel and NTSC 1f/s to 30f/s per channel	In non real-time mode: when the resolution of the main stream is 1080P, the 1/5/9/13/-channel max supports 25f/s or 30f/s and the resolution of the rest channels support 12f/s or 15f/s.
	Video Partition	1/4 windows	1/4/8/9 windows	1/4/8/9/16 windows
	Monitor Touring	Support monitor tour functions such as alarm, motion detection, and schedule auto control.		
	Resolution (PAL/NTSC)	Real time 1080P(1920*1080) Recording playback channel1/4: 1080P 1920*1080 720P 1280*720 D1 704×576/704×480 ; CIF 352×288/ 352×240; QCIF 176×144/176×120 Dual-stream supported: Extra stream resolution: D1 704×576/704×480 ;CIF 352×288/ 352×240 ; QCIF 176×144/176×120		
	Image Quality	6-level image quality (Adjustable)		
	Privacy mask	Support one privacy mask of user-defined size in full screen. Support max 4 zones.		

	Image Information	Channel information, time information and privacy mask zone.		
	TV Adjust	Adjust TV output zone suitable to anamorphic video.		
	Channel Lock	Cover secret channel with black screen though system is encoding normally. Screen-lock function to prevent unauthorized user seeing secret video.		
	Channel Information	Channel name, recording status, screen lock status, video loss status and motion detection status are shown on the bottom left of display screen.		
Audio	Audio Input	4-ch 200-2000mv 10KΩ(BNC)	8-ch 200-2000mv 10KΩ(BNC)	16-ch 200-2000mv 10KΩ(BNC)
	Audio Output	1-ch audio output 200-3000mv 5KΩ(BNC)		
	Bidirectional Audio	1-ch audio talk input 200-3000mv 10KΩ (BNC) 1-ch audio talk output 200-3000mv 5KΩ (BNC)		
Hard disk	Hard Disk	8 built-in SATA port. Support 8 HDDs.		
	Hard Disk Occupation	Audio: PCM 28.8MByte/h Video: 56-3600MByte/h		
Record and playback	Recording Mode	Manual recording, motion detection recording, schedule recording and alarm recording Priority: Manual recording> alarm recording>motion detection recording>schedule recording.		
	Recording Length	1 to 120 minutes single record duration (Default setup is 60 minutes)		
	Playback Repeat Way	When hard disk is full, system can overwrite previous video file.		
	Record Search	Various search engines such as time, type and channel.		
	Playback Mode	Various fast play, slow play speeds, manual frame by frame playback and reverse play mode.		
	Various File Switch Ways	Can switch to previous or next file or any file in current play list. Can switch to file on other channel of the same time. (If there is a file) Support file continuous play, when a file is end system auto plays the next file in the current channel		
	Multi-channel Playback	There is 1/4-channel playback mode.	There is 1/4-channel playback mode.	There is 1/4-channel playback mode.
	Window Zoom	Switch between self-adaptive screen/full screen when playback		
	Partial Enlargement	When in one-window full-screen playback mode, you can select any zone to activate partial enlargement function.		
Backup function	Backup Mode	HDD backup		
		Support peripheral USB backup device. (Flash disk, portable disk, USB burner and etc.)		
		Support peripheral eSATA backup device.		
		Support network download and backup		
Network Function	Network control	View monitor channel remotely.		
		DVR configuration through client-end and web browser		
		Upgrade via client or browser to realize remote maintenance.		
		View alarm information such as external alarm, motion detection and video loss via client.		
		Support network PTZ lens control		
		File download backup and playback		

		Multiple devices share information via corresponding software such as professional surveillance software (PSS)		
		Duplex transparent COM		
		Network alarm input and output		
		Bidirectional audio.		
Motion Detection and Alarm	Motion Detection	Zone setup: support 396/330((PAL 22×18, NTSC 22×15)) detection zones. Various sensitivity levels. Alarm can activate record or external alarm or screen message prompt.		
	Video Loss	Alarm can activate external alarm or screen message prompt.		
	External Alarm	Support record activation function or activate external alarm or screen message in specified period.		
	Manual Alarm Control	Enable or disable alarm input channel Support analog alarm signal to specific alarm output channel.		
	Alarm Input	4-ch alarm input (You can set normal open or normal close type to select the alarm type.)	8-ch alarm input (You can set normal open or normal close type to select the alarm type.)	16-ch alarm input (You can set normal open or normal close type to select the alarm type.)
	Alarm Output	6-channel relay output, including one controllable DC +12V output port.		
	Alarm Relay	30V DC 2A, 125V AC 1A (activation alarm)		
Interface	USB Interface	4 USB 2.0 ports.		
	Network connection	RJ45 10M/100M/1000M self-adaptable Ethernet port		
	RS485	Two RS485 ports. PTZ control port Support various PTZ control protocols.		
	RS232	Ordinary COM (Debug), keyboard connection and transparent serial port(COM input and output via network)		
System Information	Hard Disk Information	Display HDD current status		
	Data Stream Statistics	Data stream statistics for each channel (in wave mode)		
	Log statistics	Backup to 1024 log files. Support various search engines such as time and type.		
	Version	Display version information: channel amount, alarm input and output amount, system version and release date.		
	On-line user	Display current on-line user		
User Management	User Management	Multi-lever user management; various management modes Integrated management for local user, serial port user and network user. Configurable user power.		
		Support user /group and its corresponding rights modification. No limit to the user or group amount.		
	Password Authentication	Password modification Administrator can modify other user's password. Account lock strategy Five times login failure in thirty minutes may result in account lock.		
Upgrade		Web browser, client-end and update tool.		
Login, Logout and Shutdown		Password login protection to guarantee safety		
		User-friendly interface when login. Provide the following options: Logout /shutdown/ restart.		
		Right authentication when shut down to make sure only those proper people can turn off DVR		
	Power	AC90~264V 50+2% Hz (Max 220W)		

General Parameter	Power Consumption	50W (Exclude HDD)
	Working Temperature	0°C – +55°C
	Working Humidity	10% – 90%
	Air Pressure	86kpa – 106kpa
	Dimension	2U standard industrial case. 440(W) x460 (D) x89mm(H)
	Weight	7.0 – 8.0KG (Exclude HDD)
	Installation Mode	Desktop/rack installation

1.3.10 960H 2U Series

	Parameter	4-ch	8-ch	16-ch
System	Main Processor	High-performance industrial embedded micro controller		
	OS	Embedded LINUX		
	System Resources	Multiplex operations: Multiple-channel record, multiple-channel playback and network operation simultaneously		
	Interface	User-friendly graphical user interface		
	Input Devices	Front panel, USB mouse		
	Input Method	Arabic number, English character, donation and extension Chinese (optional)		
	Shortcut Function	Copy/paste operation, USB mouse right-key shortcut menu, double click USB mouse to switch screen.		
Compression Standard	Video Compression	H.264		
	Audio Compression	G.711A		
Video monitor	Video Input	4-CH composite video input: (NTSC/PAL) BNC (1.0V _{P-P} , 75Ω)	8-CH composite video input: (NTSC/PAL) BNC (1.0V _{P-P} , 75Ω)	16-CH composite video input: (NTSC/PAL) BNC (1.0V _{P-P} , 75Ω)
	Video Output	1-ch PAL/NTSC, BNC (1.0V _{P-P} , 75Ω) composite video signal output. 1-ch VGA output. 1-ch HDMI output. 1-ch matrix output. Support TV/VGA/HDMI video output at the same time.		
	Video Standard	PAL (625 line, 50f/s), NTSC (525 line, 60f/s)		
	Record Speed	Real-time Mode: PAL 1f/s to 25f/s per channel and NTSC 1f/s to 30f/s per channel		
	Video Partition	1/4 windows(Optional)	1/4/8/9 windows	1/4/8/9 /16 windows
	Monitor Touring	Support monitor tour functions such as alarm, motion detection, and schedule auto control.		
	Resolution (PAL/NTSC)	PAL(625TVL, 50f/s)/NTSC(525TVL, 60f/s) Real-time monitor: 960H 960 ×576/960×480		

		Playback channel 1/16: 960 ×576/960×480 D1 704×576/704×480 、 CIF 352×288/ 352×240 、 QCIF 176×144/176×120		
		Support dual streams. Extra stream resolution: CIF 352×288/ 352×240 QCIF 176×144/176×120		
	Image Quality	6-level image quality (Adjustable)		
	Privacy mask	Support one privacy mask of user-defined size in full screen. Support max 4 zones.		
	Image Information	Channel information, time information and privacy mask zone.		
	TV Adjust	Adjust TV output zone suitable to anamorphic video.		
	Channel Lock	Cover secret channel with black screen though system is encoding normally. Screen-lock function to prevent unauthorized user seeing secret video.		
	Channel Information	Channel name, recording status, screen lock status, video loss status and motion detection status are shown on the bottom left of display screen.		
	Color Configuration	Hue, brightness, contrast, saturation and gain setup for each channel.		
Audio	Audio Input	4-ch 200-2000mv 10KΩ(BNC)	8-ch 200-2000mv 10KΩ(BNC)	16-ch 200- 2000mv 10KΩ (BNC)
	Audio Output	1-ch audio output 200-3000mv 5KΩ(BNC)		
	Bidirectional Audio	1-ch audio talk input 200-3000mv 10KΩ (BNC) 1-ch audio talk output 200-3000mv 5KΩ (BNC)		
Hard disk	Hard Disk	8 built-in SATA port. Support 8 HDDs.		
	Hard Disk Occupation	Audio: PCM 28.8MByte/h Video: 56-900MByte/h		
Record and playback	Recording Mode	Manual recording, motion detection recording, schedule recording and alarm recording Priority: Manual recording> alarm recording>motion detection recording>schedule recording.		
	Recording Length	1 to 120 minutes single record duration (Default setup is 60 minutes)		
	Playback Repeat Way	When hard disk is full, system can overwrite previous video file.		
	Record Search	Various search engines such as time, type and channel.		
	Playback Mode	Various fast play, slow play speeds, manual frame by frame playback and reverse play mode.		
	Various File Switch Ways	Can switch to previous or next file or any file in current play list. Can switch to file on other channel of the same time. (If there is a file) Support file continuous play, when a file is end system auto plays the next file in the current channel		
	Multi-channel Playback	There is 1/4/9/16-channel playback mode. (It may vary due to different series.)		
	Window Zoom	Switch between self-adaptive screen/full screen when playback		
	Partial Enlargement	When in one-window full-screen playback mode, you can select any zone to activate partial enlargement function.		
Backup	Backup Mode	HDD backup		

function		Support peripheral USB backup device. (Flash disk, portable disk, USB burner and etc.)		
		Support peripheral eSATA backup device.		
		Support network download and backup		
Network Function	Network control	View monitor channel remotely.		
		DVR configuration through client-end and web browser		
		Upgrade via client or browser to realize remote maintenance.		
		View alarm information such as external alarm, motion detection and video loss via client.		
		Support network PTZ lens control		
		File download backup and playback		
		Multiple devices share information via corresponding software such as professional surveillance software (PSS)		
		Duplex transparent COM		
		Network alarm input and output		
		Bidirectional audio.		
Motion Detection and Alarm	Motion Detection	Zone setup: support 396/330((PAL 22×18, NTSC 22×15)) detection zones. Various sensitivity levels. Alarm can activate record or external alarm or screen message prompt.		
	Video Loss	Alarm can activate external alarm or screen message prompt.		
	External Alarm	Support record activation function or activate external alarm or screen message in specified period.		
	Manual Alarm Control	Enable or disable alarm input channel Support analog alarm signal to specific alarm output channel.		
	Alarm Input	4-ch alarm input (You can set normal open or normal close type to select the alarm type.)	8-ch alarm input (You can set normal open or normal close type to select the alarm type.)	16-ch alarm input (You can set normal open or normal close type to select the alarm type.)
	Alarm Output	6-channel relay output, including one controllable DC +12V output port.		
	Alarm Relay	30V DC 2A, 125V AC 1A (activation alarm)		
Interface	USB Interface	3 USB 2.0 ports.		
	Network connection	2 RJ45 10M/100M/1000M self-adaptable Ethernet port		
	RS485	PTZ control port Support various PTZ control protocols.		
	RS232	Ordinary COM (Debug),keyboard connection and transparent serial port(COM input and output via network)		
System Information	Hard Disk Information	Display HDD current status		
	Data Stream Statistics	Data stream statistics for each channel (in wave mode)		
	Log statistics	Backup to 1024 log files. Support various search engines such as time and type.		
	Version	Display version information: channel amount, alarm input and output amount, system version and release date.		
	On-line user	Display current on-line user		
User Management	User Management	Multi-lever user management; various management modes Integrated management for local user, serial port user and network user. Configurable user power.		
		Support user /group and its corresponding rights modification. No limit to the user or group amount.		

	Password Authentication	Password modification Administrator can modify other user's password. Account lock strategy Five times login failure in thirty minutes may result in account lock.
Upgrade		Web browser, client-end and update tool.
Login, Logout and Shutdown		Password login protection to guarantee safety User-friendly interface when login. Provide the following options: Logout /shutdown/ restart. Right authentication when shut down to make sure only those proper people can turn off DVR
General Parameter	Power	AC90~264V 50+2% Hz (Max 220W)
	Power Consumption	25W (Exclude HDD)
	Working Temperature	0°C – +55°C
	Working Humidity	10% – 90%
	Air Pressure	86kpa – 106kpa
	Dimension	2U standard industrial case. 440(W) x460 (D) x89mm(H)
	Weight	6.5-7.5KG(Exclude HDD)
	Installation Mode	Desktop/rack installation

2 Overview and Controls

This section provides information about front panel and rear panel. When you install this series DVR for the first time, please refer to this part first.

2.1 Front Panel

2.1.1 1U series

The front panel is shown as in Figure 2-1.

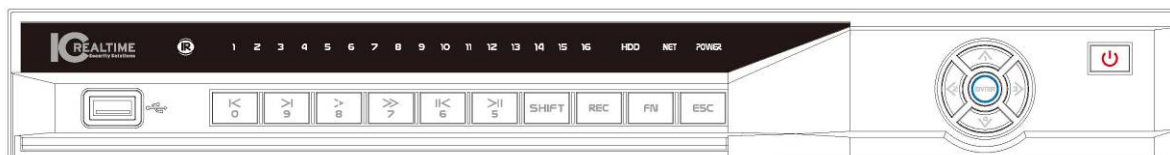



Figure 2-1

Please refer to the following sheet for front panel button information.

Name	Icon	Function
Power button		Power button, press this button for three seconds to boot up or shut down DVR.
Shift	Shift	In textbox, click this button to switch between numeral, English(Small/Capitalized),donation and etc.
Up/1 Down/4		Activate current control, modify setup, and then move up and down.
		Increase/decrease numeral.
		Assistant function such as PTZ menu.
		In text mode, input number 1/4 (English character G/H/I)
Left/2 Right/3		Shift current activated control,
		When playback, click these buttons to control playback bar. In text mode, input number 2(English character A/B/C) /3(English character D/E/F)
ESC	ESC	Go to previous menu, or cancel current operation.
		When playback, click it to restore real-time monitor mode.
Enter	ENTER	Confirm current operation
		Go to default button
		Go to menu
Record	REC	Manually stop/start recording, working with direction keys or numeral keys to select the recording channel.
Slow play/8		Multiple slow play speeds or normal playback. In text mode, input number 8 (English character T/U/V).
Assistant	Fn	One-window monitor mode, click this button to display assistant function: PTZ control and image color.

		<p>Backspace function: in numeral control or text control, press it for 1.5seconds to delete the previous character before the cursor.</p> <p>In motion detection setup, working with Fn and direction keys to realize setup.</p> <p>In text mode, click it to switch between numeral, English character(small/capitalized) and etc.</p> <p>Realize other special functions.</p>
Fast play/7	▶▶	<p>Various fast speeds and normal playback. In text mode, input number 7 (English character P/Q/R/S).</p>
Play previous/0	◀	<p>In playback mode, playback the previous video In text mode, input number 0.</p>
Reverse/Pause/6	◀	<p>In normal playback or pause mode, click this button to reverse playback In reverse playback, click this button to pause playback. In text mode, input number 6 (English character M/N/O)</p>
Play Next/9	▶	<p>In playback mode, playback the next video In menu setup, go to down ward of the dropdown list. In text mode, input number 9 (English character W/X/Y/Z)</p>
Play/Pause /5	▶	<p>In normal playback click this button to pause playback In pause mode, click this button to resume playback. In text mode, input number 5(English character J/K/L).</p>
USB port		To connect USB storage device, USB mouse.
Network abnormal indication light	Net	Network error occurs or there is no network connection, the light becomes red to alert you.
HDD abnormal indication light	HDD	HDD error occurs or HDD capacity is below specified threshold value, the light becomes red to alert you.
Record light	1-16	System is recording or not. It becomes on when system is recording.
IR Receiver	IR	It is to receive the signal from the remote control.
Alarm indication light	Alarm	Here you can view there is external alarm input or not. The light becomes on when there is an external alarm. The light become off when the external alarm stops.

2.1.2 1.5U series

The front panel is shown as below. See Figure 2-2.

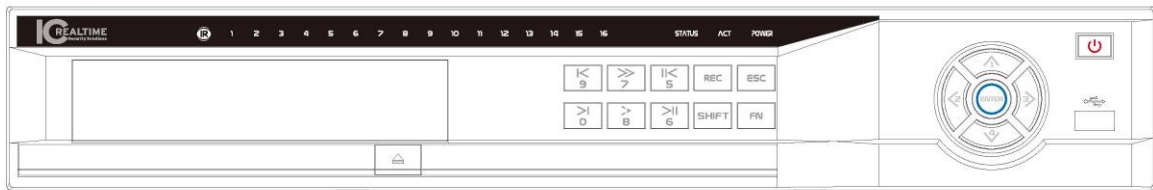

Figure 2-2

Please refer to the following sheet for front panel button information.

Name	Icon	Function
Power button		Power button, press this button for three seconds to boot up or shut down DVR.
USB port		To connect USB storage device, USB mouse.
Up/Down		Activate current control, modify setup, and then move up and down.
		Increase/decrease numeral.
		Assistant function such as PTZ menu.
Left/Right		Shift current activated control, and then move left and right.
		When playback, click these buttons to control playback bar.
		Input number 2/3.
Enter	ENTER	Confirm current operation
		Go to default button
		Go to menu
Reverse/Pause		In normal playback or pause mode, click this button to reverse Playback Input number 5.
Play/Pause		In normal playback click this button to pause playback In pause mode, click this button to resume playback. Input number 6.
Slow play		Multiple slow play speeds or normal playback. Input number 8.
Fast play		Various fast speeds and normal playback. Input number 7.
Play previous		In playback mode, playback the previous video. Input number 9.
Play Next		In playback mode, playback the next video Input number 0.
ESC	ESC	Go to previous menu, or cancel current operation.
		When playback, click it to restore real-time monitor mode.
Assistant	Fn	One-window monitor mode, click this button to display assistant function: PTZ control and image color.

		Backspace function: in numeral control or text control, press it for 1.5 seconds to delete the previous character before the cursor.
		In motion detection setup, working with Fn and direction keys to realize setup.
		In text mode, click it to switch between numeral, English character(small/capitalized) and etc.
		In HDD management interface, you can click it to switch HDD record information and other information (Menu prompt)
		Realize other special functions.
Shift	↑	In textbox, click this button to switch between numeral, English(Small/Capitalized),donation and etc.
Record	REC	Manually stop/start recording, working with direction keys or numeral keys to select the recording channel.
Remote control indication light	ACT	Remote control indication light
Status indication light	Status	If there is Fn indication light, current status indication light is null.
Power indication light	Power	Power indication light
Record light	1-16	System is recording or not. It becomes on when system is recording.
IR Receiver	IR	It is to receive the signal from the remote control.
CD-ROM button	⏏	Pop-up or insert the CD.

2.1.3 2U series

The Front panel is shown as follows. See Figure 2-3.





Figure 2-3

Please refer to the following sheet for front panel button information.

Name	Icon	Function
Power button	⏻	Power button, press this button for three seconds to boot up or shut down DVR.
Number and Character	0	In text mode, input number 0. It is the space button.
	1,.	In text mode, input number 1 and denotation.

	2ABC	In text mode, input number 2(English character A/B/C)
	3DEF	In text mode, input number 3(English character D/E/F)
	4GHI	In text mode, input number 4 (English character G/H/I)
	5JKL	In text mode, input number 5(English character J/K/L).
	6MNO	In text mode, input number 6 (English character M/N/O)
	7PQRS	In text mode, input number 7 (English character P/Q/R/S).
	8TUV	In text mode, input number 8 (English character T/U/V).
	9WXYZ	In text mode, input number 9 (English character W/X/Y/Z)
	-/--	If you want to input a number more than 10, please click this button and then input.
Shift	↑	In textbox, click this button to switch between numeral, English(Small/Capitalized),donation and etc.
Up Down	▲、▼	Activate current control, modify setup, and then move up and down.
		Increase/decrease numeral.
		Assistant function such as PTZ menu.
Left Right	◀ ▶	Shift current activated control,
		When playback, click these buttons to control playback bar.
ESC	ESC	Go to previous menu, or cancel current operation.
		When playback, click it to restore real-time monitor mode.
Enter	ENTER	Confirm current operation
		Go to default button
		Go to menu
Record	REC	Manually stop/start recording, working with direction keys or numeral keys to select the recording channel.
Window switch	Mult	Click it to switch one-window/multiple-window.
Slow play/8	▶	Multiple slow play speeds or normal playback.
Assistant	Fn	One-window monitor mode, click this button to display assistant function: PTZ control and image color.
		Backspace function: in numeral control or text control, press it for 1.5seconds to delete the previous character before the cursor.
		In motion detection setup, working with Fn and direction keys to realize setup.
		In text mode, click it to switch between numeral, English character(small/capitalized) and etc.

		Realize other special functions.
Fast play	▶▶	Various fast speeds and normal playback.
Play previous	◀	In playback mode, playback the previous video
Reverse/Pause	◀	In normal playback or pause mode, click this button to reverse playback In reverse playback, click this button to pause playback.
Play Next	▶	In playback mode, playback the next video In menu setup, go to down ward of the dropdown list.
Play/Pause	▶	In normal playback click this button to pause playback In pause mode, click this button to resume playback.
USB port		To connect USB storage device, USB mouse.
Status indication light	Status	If there is Fn indication light, current status indication light is null.
HDD abnormal indication	HDD	HDD error occurs or HDD capacity is below specified threshold value, the light becomes red to alert you.
Remote control indication light	ACT	Remote control indication light
Power indication light	Power	Power indication light
Record light	1-16	System is recording or not. It becomes on when system is recording. For this series product, the last 12 lights are null since there is only four channels.
IR Receiver	IR	It is to receive the signal from the remote control.
Shuttle(outer ring)		In real-time monitor mode it works as left/right direction key. Playback mode, counter clockwise to forward and clock wise to backward.
Jog(inner dial)		Up/down direction key. Playback mode, turn the inner dial to realized frame by frame playback. (Only applies to some special versions.)
CD-ROM button		Pop-up or insert the CD.

2.2 Rear Panel

2.2.1 1U series

The 4/8-channel series DVR rear panel is shown as below. See Figure 2-4.

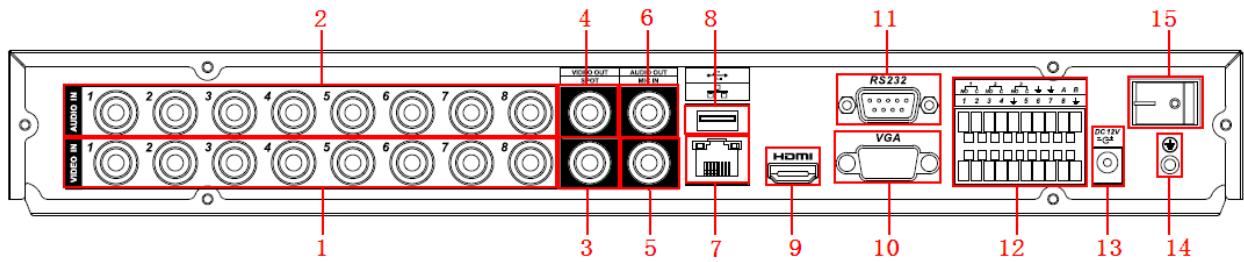

Figure 2-4

The 16-channel series DVR rear panel is shown as below. See Figure 2-5.

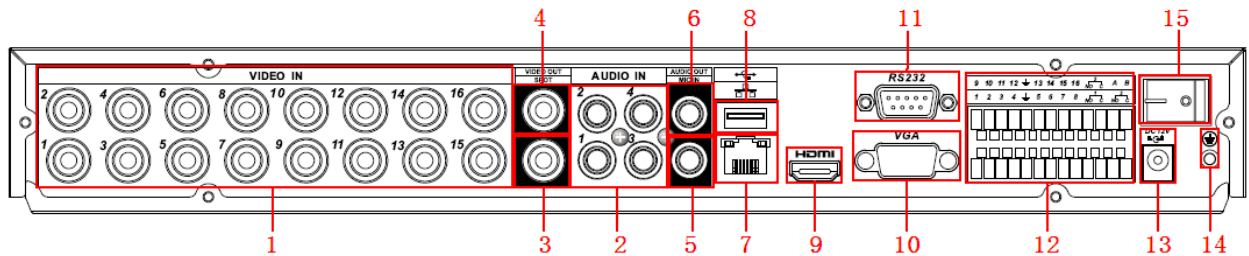

Figure 2-5

Please refer to the following sheet for detailed information.

1	Video input
2	Audio input
3	Video spot output
4	Video CVBS output
5	Bidirectional talk input
6	Audio output
7	Network port
8	USB port
9	HDMI port
10	Video VGA output
11	RS232 port
12	Alarm input/alarm output/RS485 port
13	Power socket
14	GND port
15	On/off button

2.2.2 960H 1U Series

The 8-channel series DVR rear panel is shown as below. See Figure 2-6.

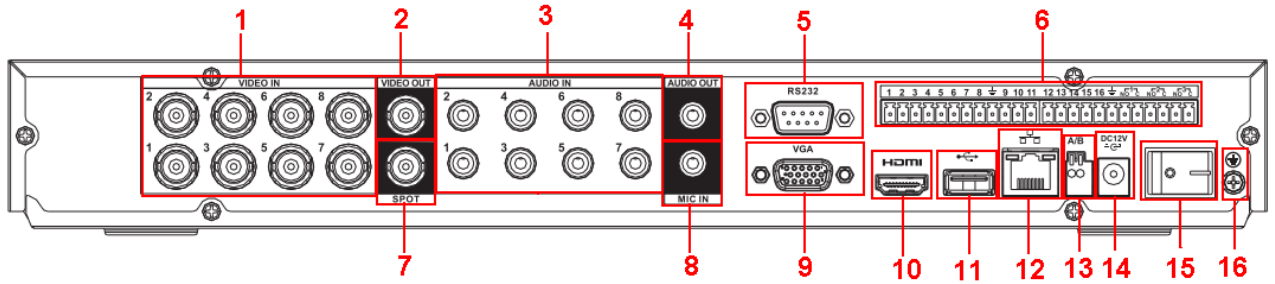

Figure 2-6

Please refer to the following sheet for detailed information.

1	Video input
2	Video output
3	Audio input
4	Audio output
5	RS232 port
6	Alarm input/alarm output
7	Video SPOT output
8	Bidirectional talk input
9	Video VGA output
10	HDMI port
11	USB port
12	Network port
13	RS485 port
14	Power input port
15	Power button
16	GND port

2.2.3 Full-D1 1.5U series

The rear panel is shown as in Figure 2-7.

The following figure is based on the 16-channel series product.

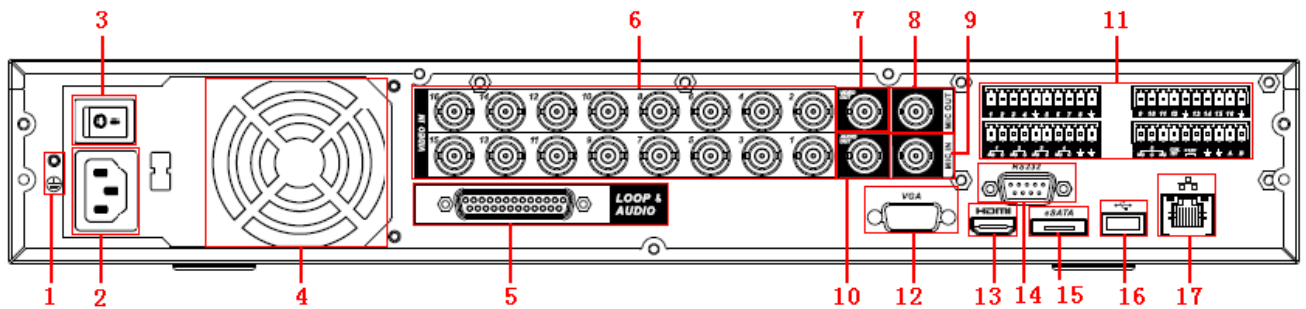

Figure 2-7

Please refer to the following sheet for detailed information.

1	GND port
2	Power input port
3	Power button
4	Fan
5	Audio input /Matrix video output/Loop video output
6	Video input

7	Video CVBS output
8	Bidirectional talk input port
9	Bidirectional talk output port
10	Audio output
11	Alarm input/Alarm output/RS485 port
12	Video VGA output
13	HDMI port
14	RS232 port
15	eSATA port
16	USB port
17	Network port

2.2.4 HD-SDI 1080P 1.5U Series

The rear panel of 4/8-channel series product is shown as in Figure 2-8.

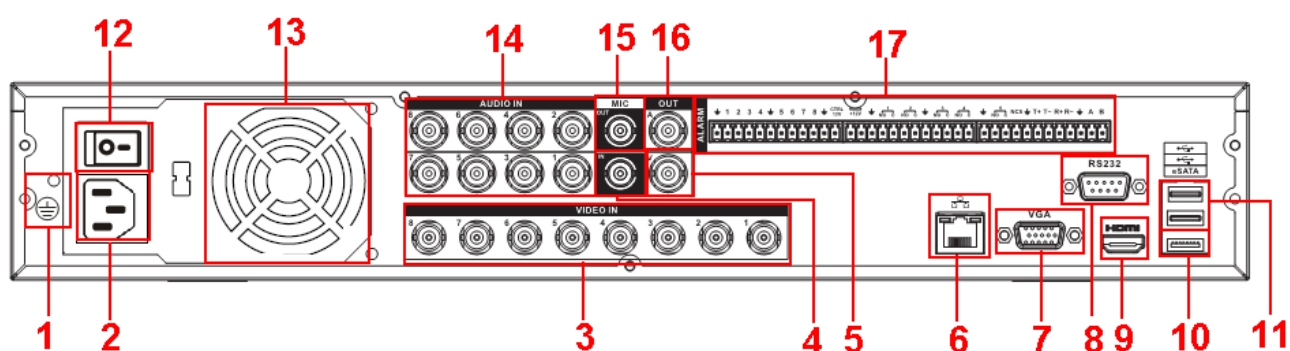

Figure 2-8

Please refer to the following sheet for detailed information.

1	GND port
2	Power input port
3	Video input
4	Bidirectional talk input port
5	Video output
6	Network port
7	Video VGA output
8	RS232 port
9	HDMI port
10	eSATA port
11	USB port
12	Power button
13	Fan
14	Audio input
15	Bidirectional talk output port
16	Audio output
17	Alarm input/Alarm output/RS485 port

The rear panel of the 16-channel series product is shown as in Figure 2-9.

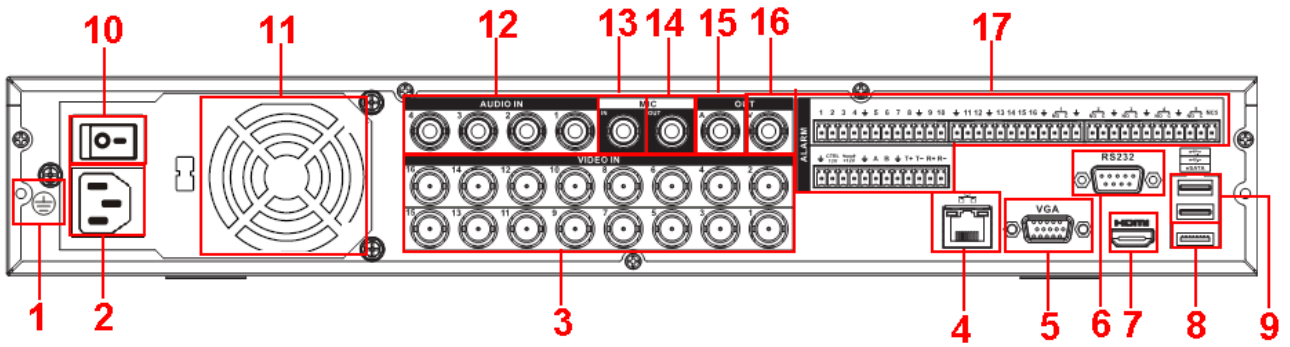

Figure 2-9

Please refer to the following sheet for detailed information.

1	GND port
2	Power input port
3	Video input
4	Network port
5	Video VGA output
6	RS232 port
7	HDMI port
8	eSATA port
9	USB port
10	Power on/off button
11	Fan
12	Audio input
13	Bidirectional talk input port
14	Bidirectional talk output port
15	Audio output
16	Video output
17	Alarm input/Alarm output/RS485 port

2.2.5 Simple 1.5U Series

This series DVR rear panel is shown as below. See Figure 2-10.

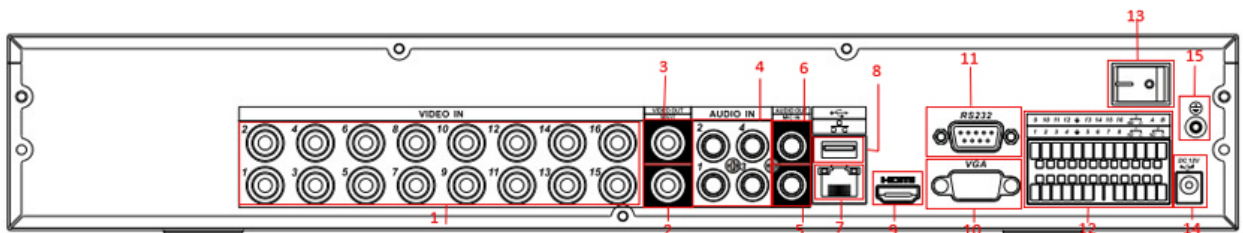

Figure 2-10

Please refer to the following sheet for detailed information.

1	Video input
2	Video spot output
3	Video CVBS output
4	Audio input
5	Bidirectional talk input
6	Audio output

7	Network port
8	USB port
9	HDMI port
10	Video VGA output
11	RS232 port
12	Alarm input/alarm output/RS485 port
13	On/off button
14	Power socket
15	GND port

2.2.6 960H 4HDD 1.5U Series

The 16-channel series DVR rear panel is shown as in Figure 2-11.

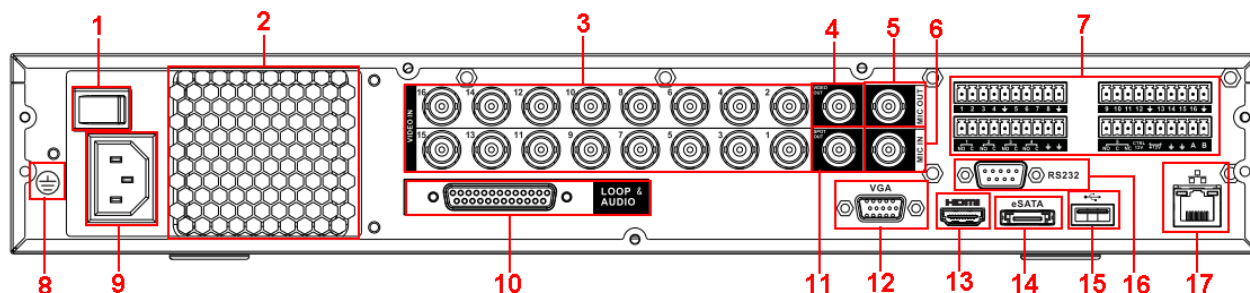

Figure 2-11

Please refer to the following sheet for detailed information.

1	Power button
2	Power
3	Video input
4	Audio output
5	Bidirectional talk output port
6	Bidirectional talk input port
7	Alarm input/Alarm output/RS485 port
8	GND port
9	Power input port
10	Audio input /Matrix video output/Loop video output
11	Video SPOT output
12	Video VGA output
13	HDMI port
14	eSATA port
15	USB port
16	RS232 port
17	Network port

2.2.7 960H 2HDD 1.5U Series

This series DVR rear panel is shown as below. See Figure 2-12.

Please note the following figure is based on the 8-channel series product.

5	DB25 port (5 th to 16 th -channel audio input port)
6	1 st to 4 th -channel audio input
7	Loop video output
8	Video input
9	Video CVBS output
10	Matrix video output
11	Audio output
12	Bidirectional talk input port
13	Bidirectional talk output port
14	Alarm input/Alarm output/RS485 port HDMI port
15	Video VGA output
16	HDMI port
17	Video CVBS output RS232 port
18	Video matrix output eSATA port
19	USB port
20	Network port

The 32-channel series DVR rear panel is shown as below. See Figure 2-14.

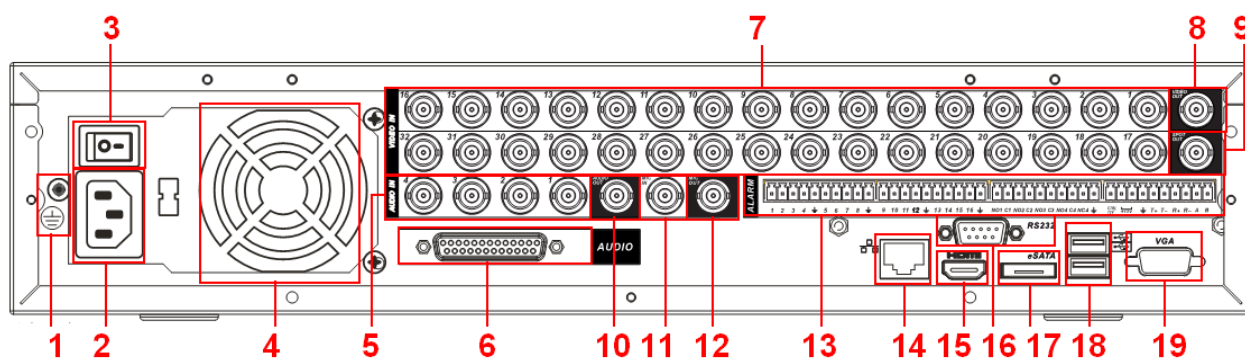

Figure 2-14

Please refer to the following sheet for detailed information.

1	GND port
2	Power input port
3	Power button
4	Fan
5	1 st to 4 th -channel audio input
6	DB25 port (5 th to 16 th -channel audio input port)
7	Video input
8	Video CVBS output
9	Matrix video output
10	Audio output
11	Bidirectional talk input port
12	Bidirectional talk output port
13	Alarm input/Alarm output/RS485 port
14	Network port
15	HDMI port
16	RS232 port
17	eSATA port
18	USB port
19	Video VGA output

2.2.9 HD-SDI 1080P 2U Series

The rear panel 4/8-channel series product is shown as in Figure 2-15.

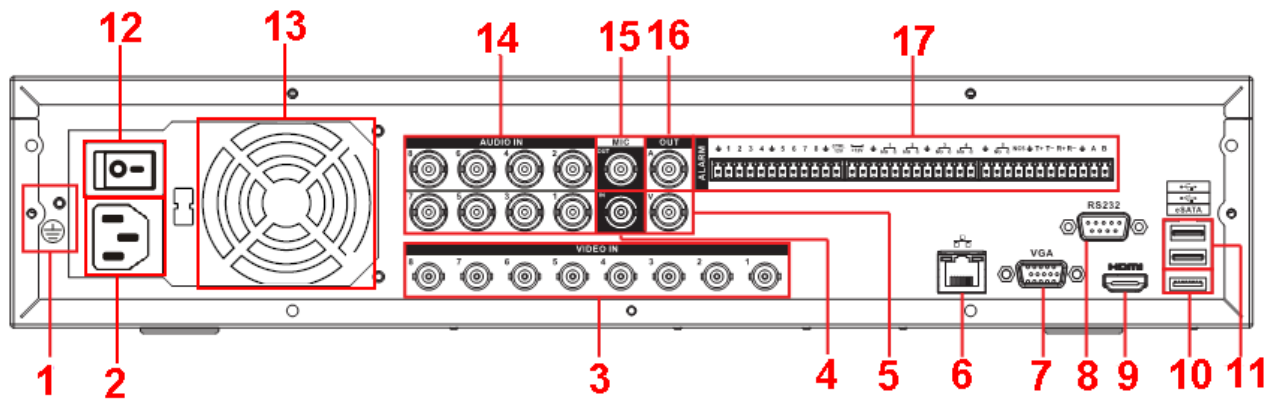

Figure 2-15

Please refer to the following sheet for detailed information.

1	GND port
2	Power input port
3	Video input
4	Bidirectional talk input port
5	Video output
6	Network port
7	Video VGA output
8	RS232 port
9	HDMI port
10	eSATA port
11	USB port
12	Power button
13	Fan
14	Audio input
15	Bidirectional talk output port
16	Audio output
17	Alarm input/Alarm output/RS485 port

The rear panel of the 16-channel series product is shown as in Figure 2-16.

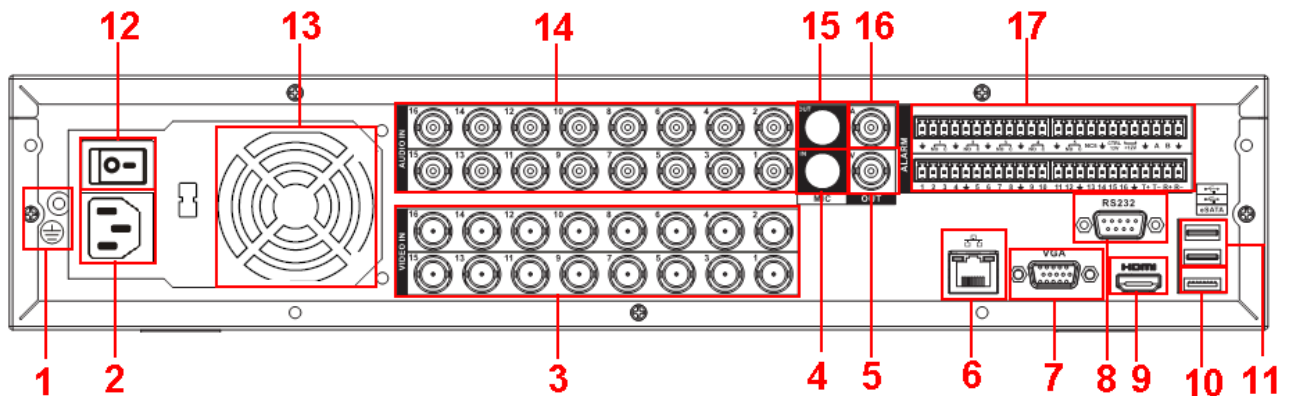

Figure 2-16

Please refer to the following sheet for detailed information.

1	GND port
---	----------

2	Power input port
3	Video input
4	Bidirectional talk input port
5	Video output
6	Network port
7	Video VGA output
8	RS232 port
9	HDMI port
10	eSATA port
11	USB port
12	Power on/off button
13	Fan
14	Audio input
15	Bidirectional talk output port
16	Audio output
17	Alarm input/Alarm output/RS485 port

2.2.10 960H 2U Series

The rear panel is shown as in Figure 2-17.

Please note the following figure is based on the 16-channel series product.

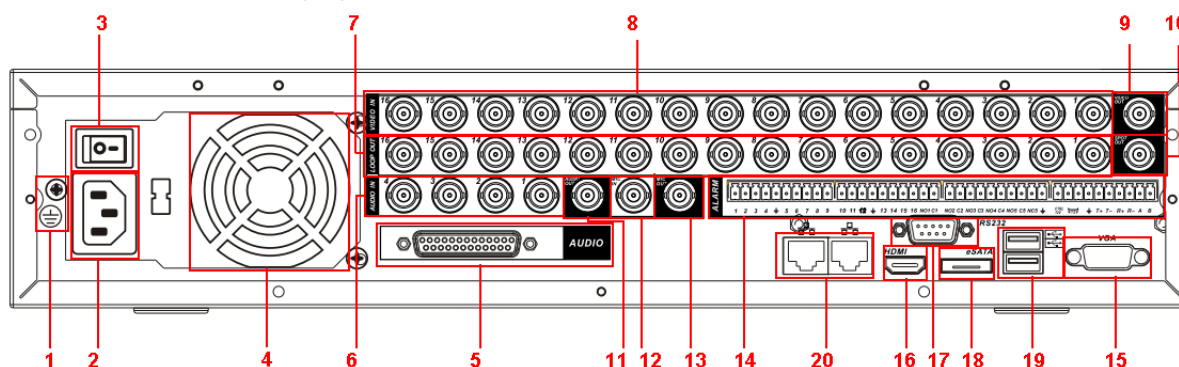

Figure 2-17

Please refer to the following sheet for detailed information.

1	GND port
2	Power input port
3	Power button
4	Fan
5	DB25 port (5-16 channel audio input)
6	1-4channel audio input
7	Loop video output
8	Video input
9	Video CVBS output
10	Matrix video output
11	Audio output
12	Bidirectional talk input port
13	Bidirectional talk output port
14	Alarm input/Alarm output/RS485 port
15	Video VGA output
16	HDMI port
17	RS-232
18	eSATA port

19	USB port
20	Network port

When connect the Ethernet port, please use crossover cable to connect the PC and use the straight cable to connect to the switcher or router.

2.3 Connection Sample

2.3.1 General 1U series

Please refer to Figure 2-18 for connection sample.

The following figure is based on the 8-channel series product.

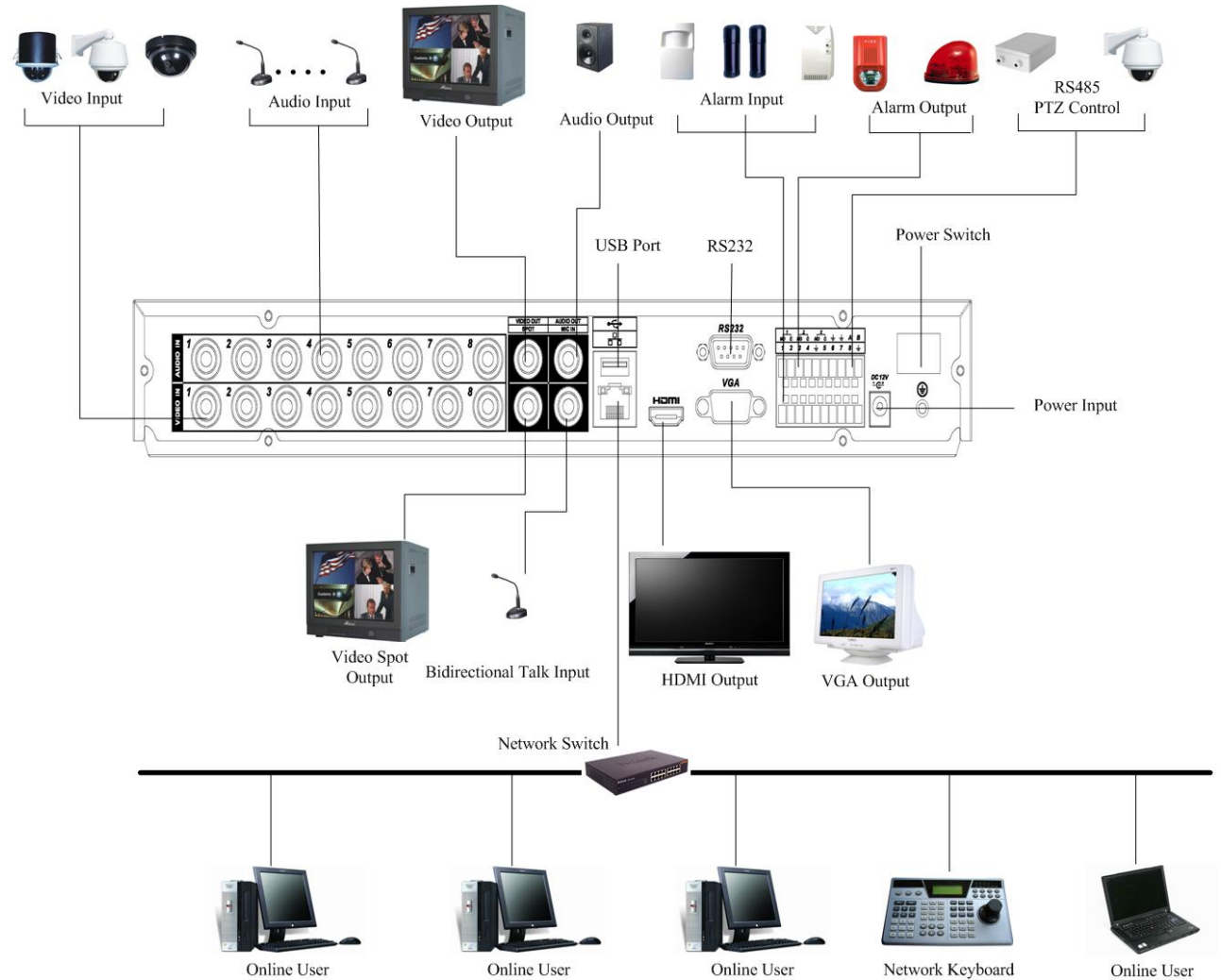

Figure 2-18

2.3.2 960H 1U Series

Please refer to Figure 2-19 for connection sample.

The following figure is based on the 8-channel series product.

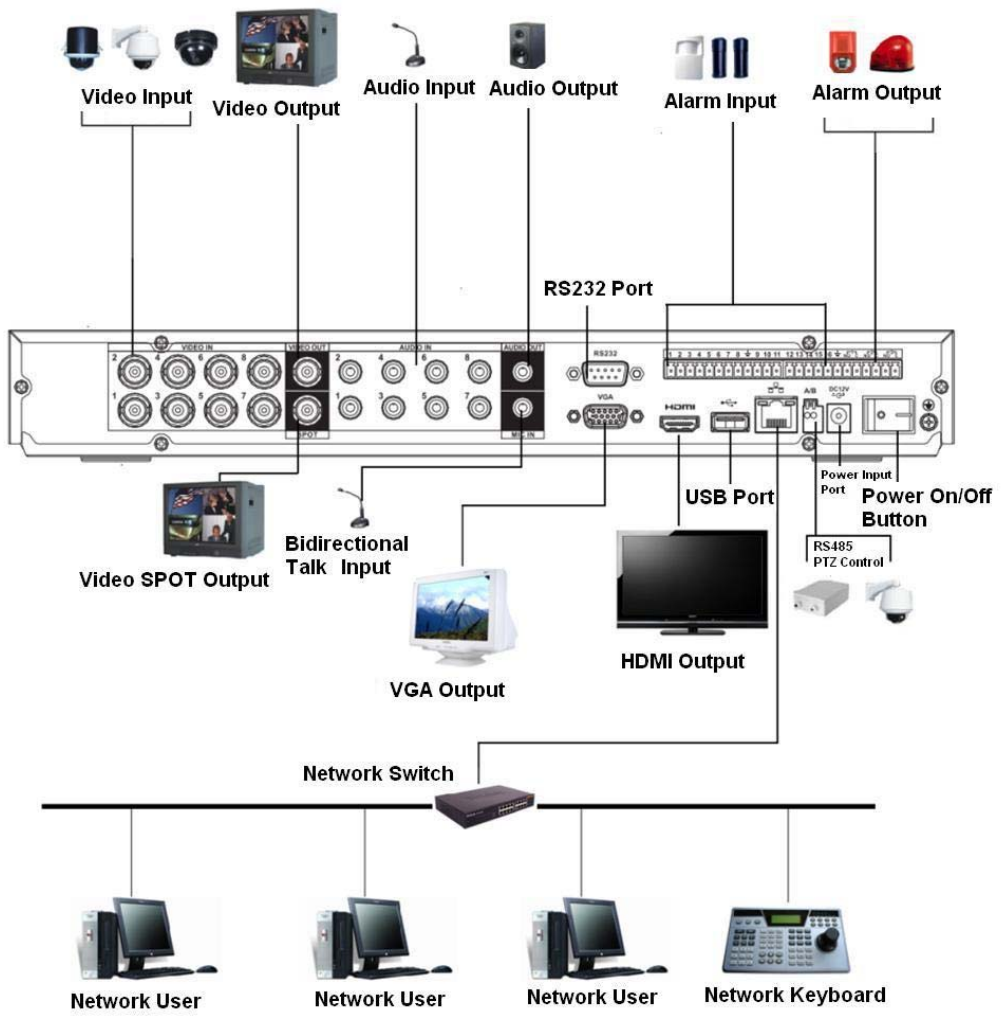

Figure 2-19

2.3.3 General 1.5U series

Please refer to Figure 2-20 for connection sample.

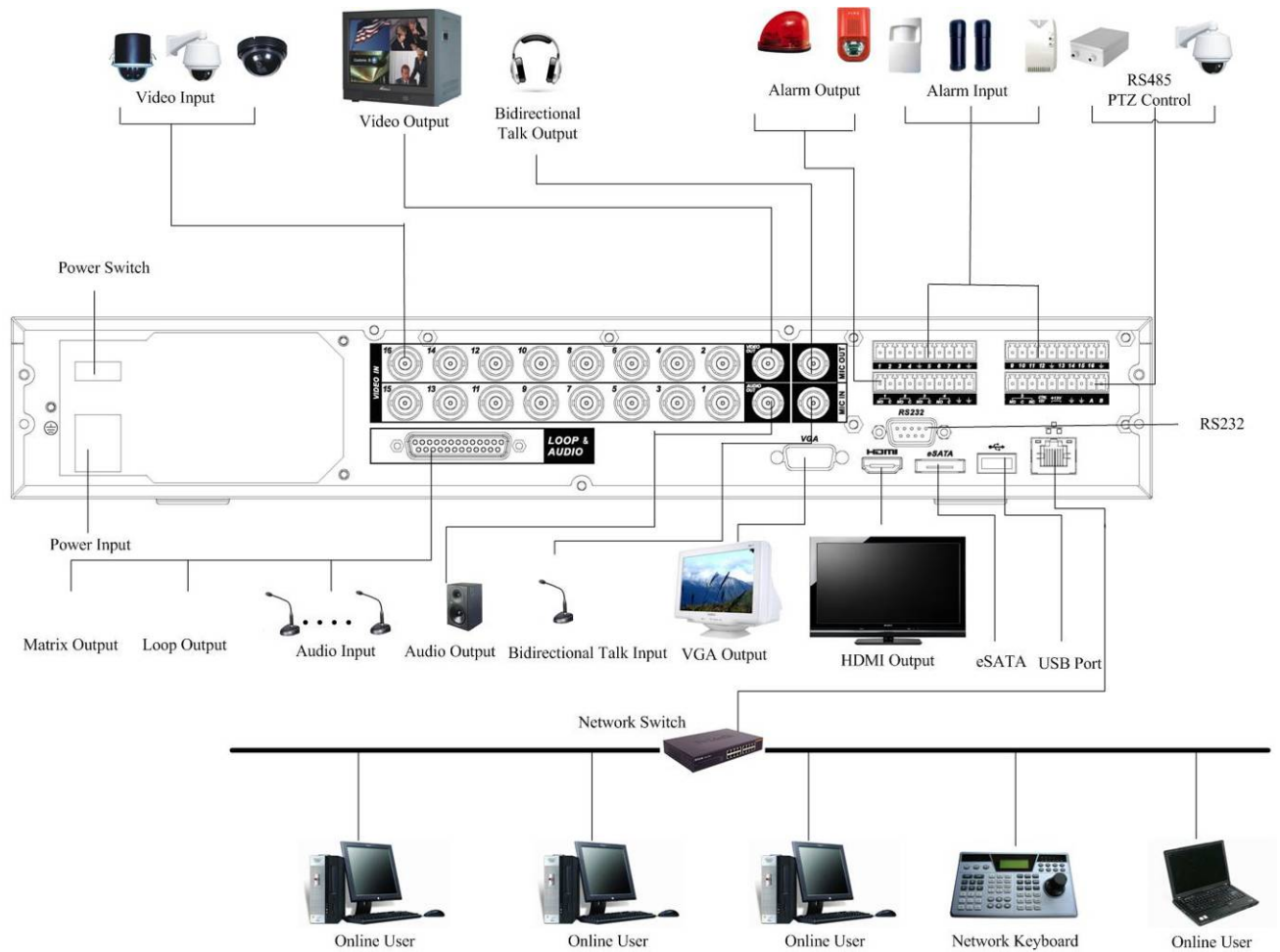

Figure 2-20

Note: There are slight differences for simple 1.5U connection.

2.3.4 HD-SDI 1.5U Series

Please refer to Figure 2-21 for connection sample.

The following figure is based on the 16-channel series product.

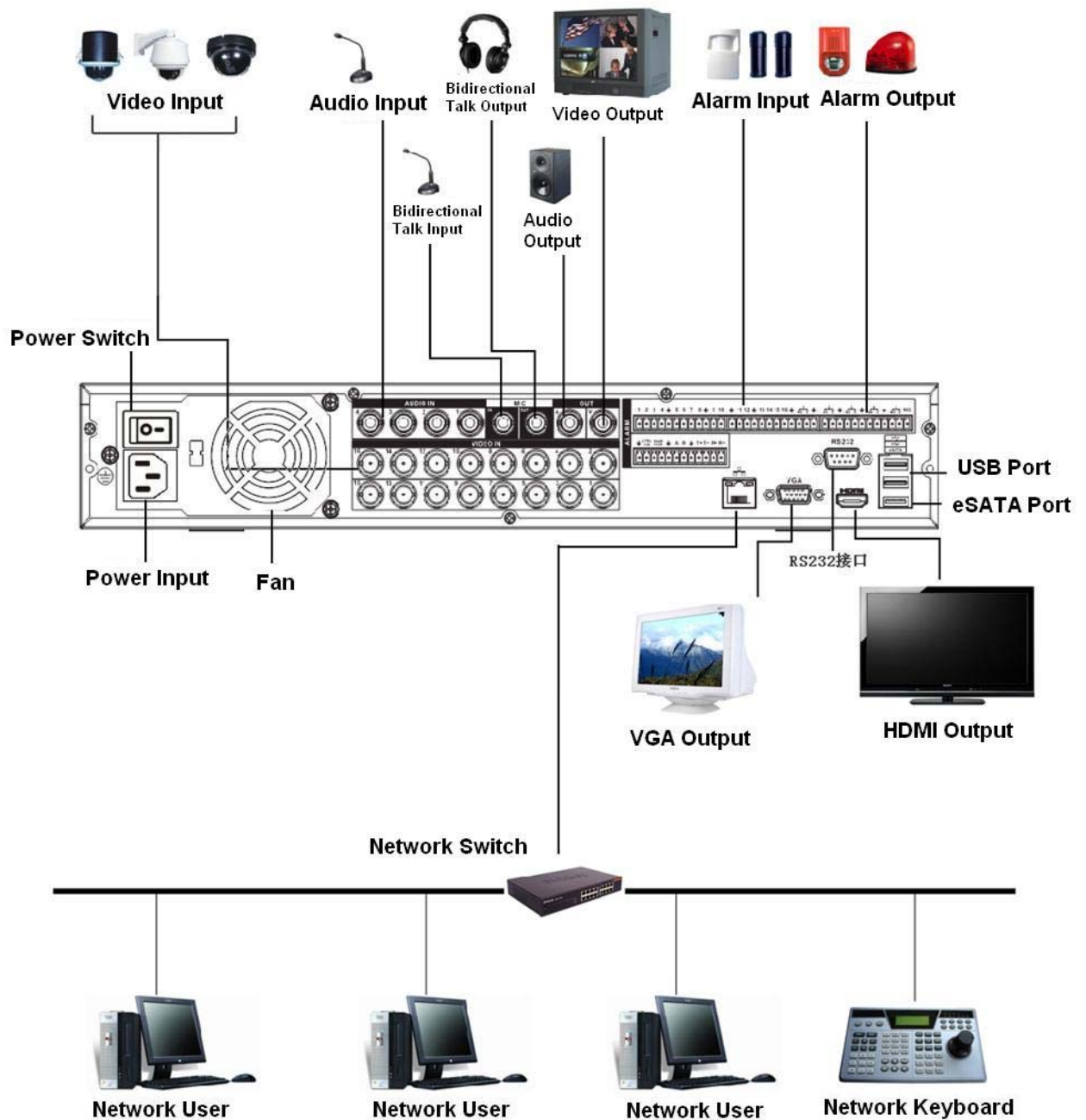

Figure 2-21

2.3.5 960H 4HDD 1.5U Series

Please refer to Figure 2-22 for connection sample.

The following figure is based on the 16-channel series product.

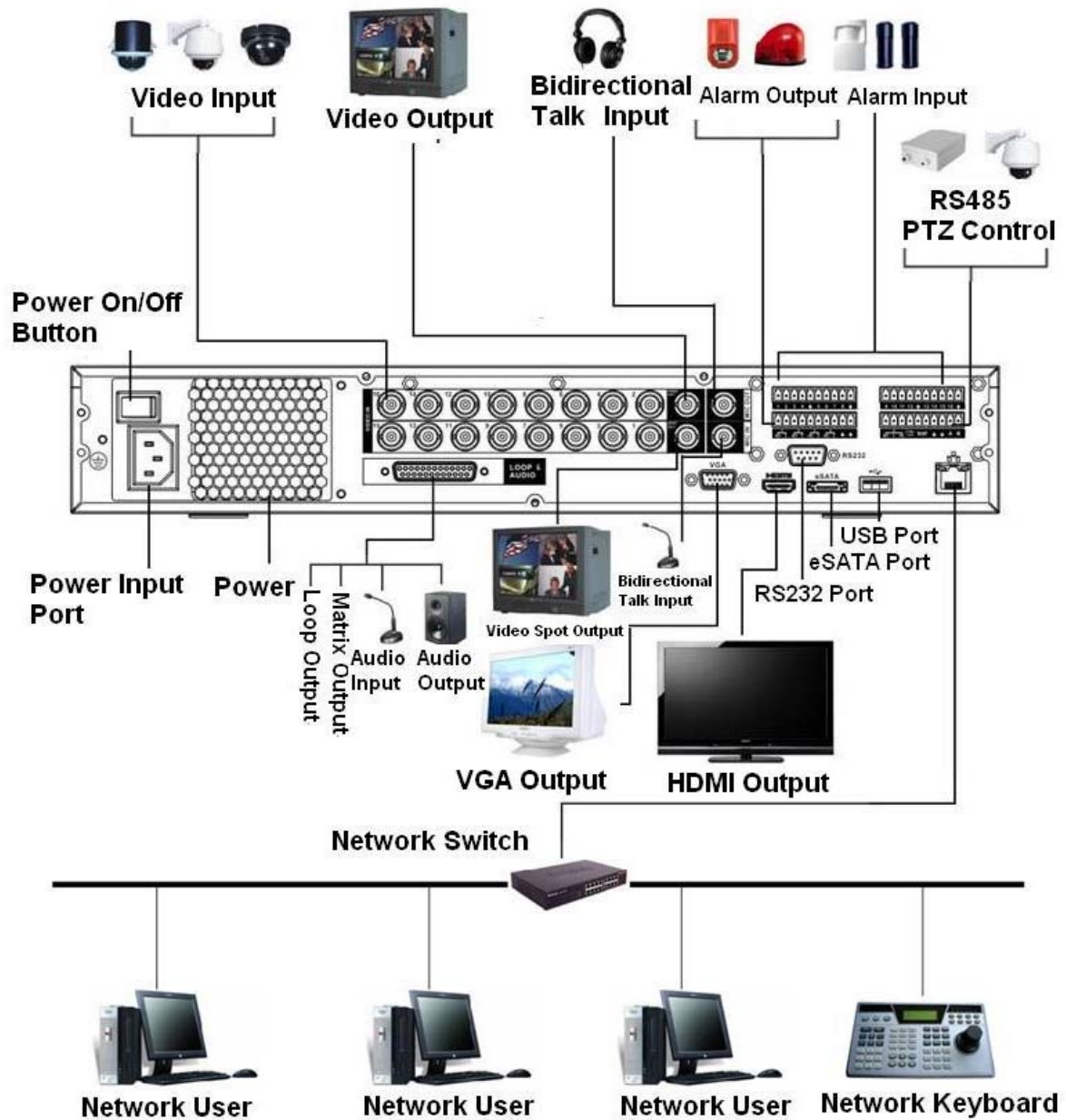

Figure 2-22

2.3.6 960H 2HDD 1.5U Series

Please refer to Figure 2-23 for connection sample.

The following figure is based on the 8-channel series product.

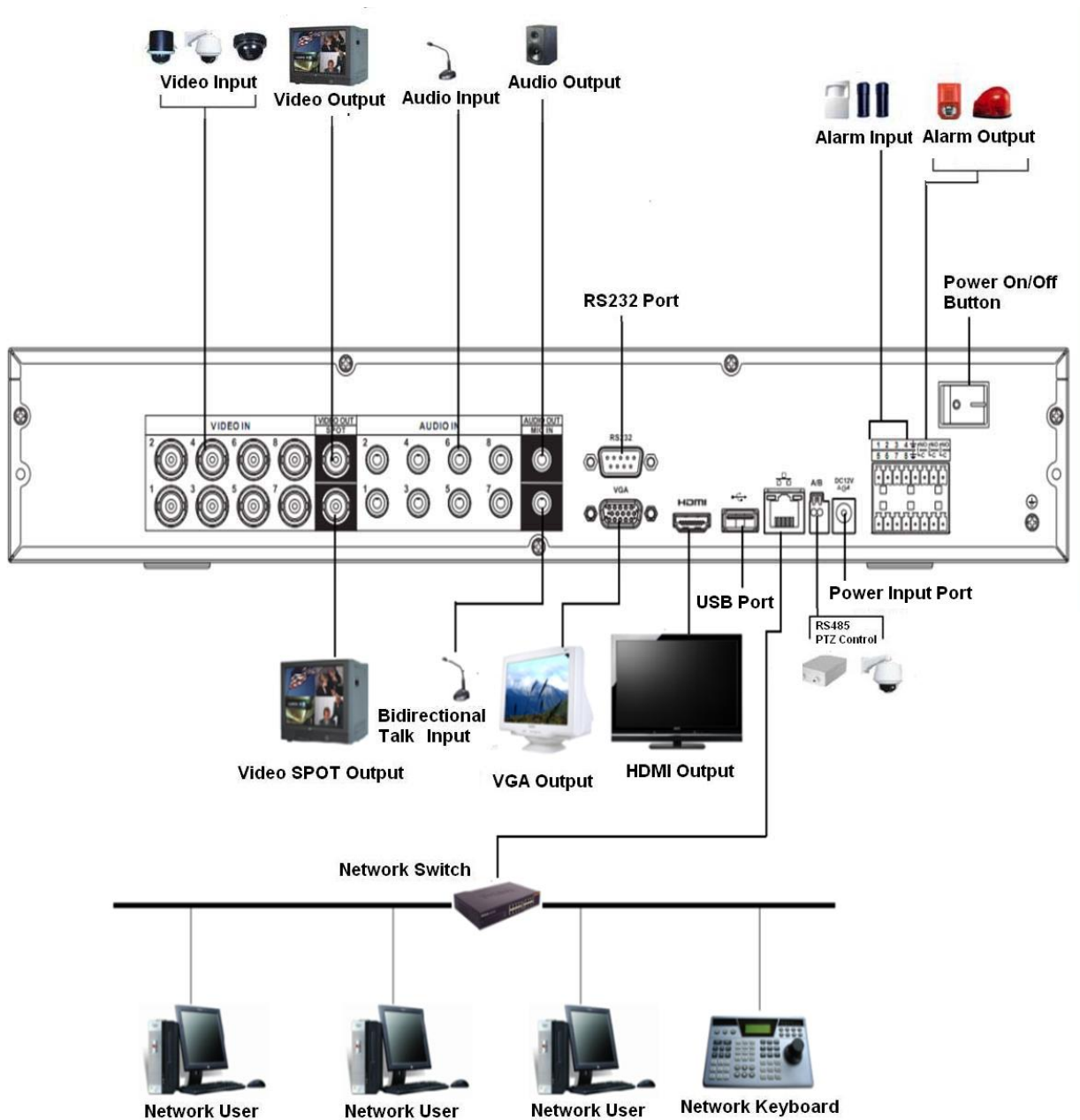

Figure 2-23

2.3.7 General 2U series

Please refer to Figure 2-24 for connection sample.

The following figure is based on the 16-channel series product.

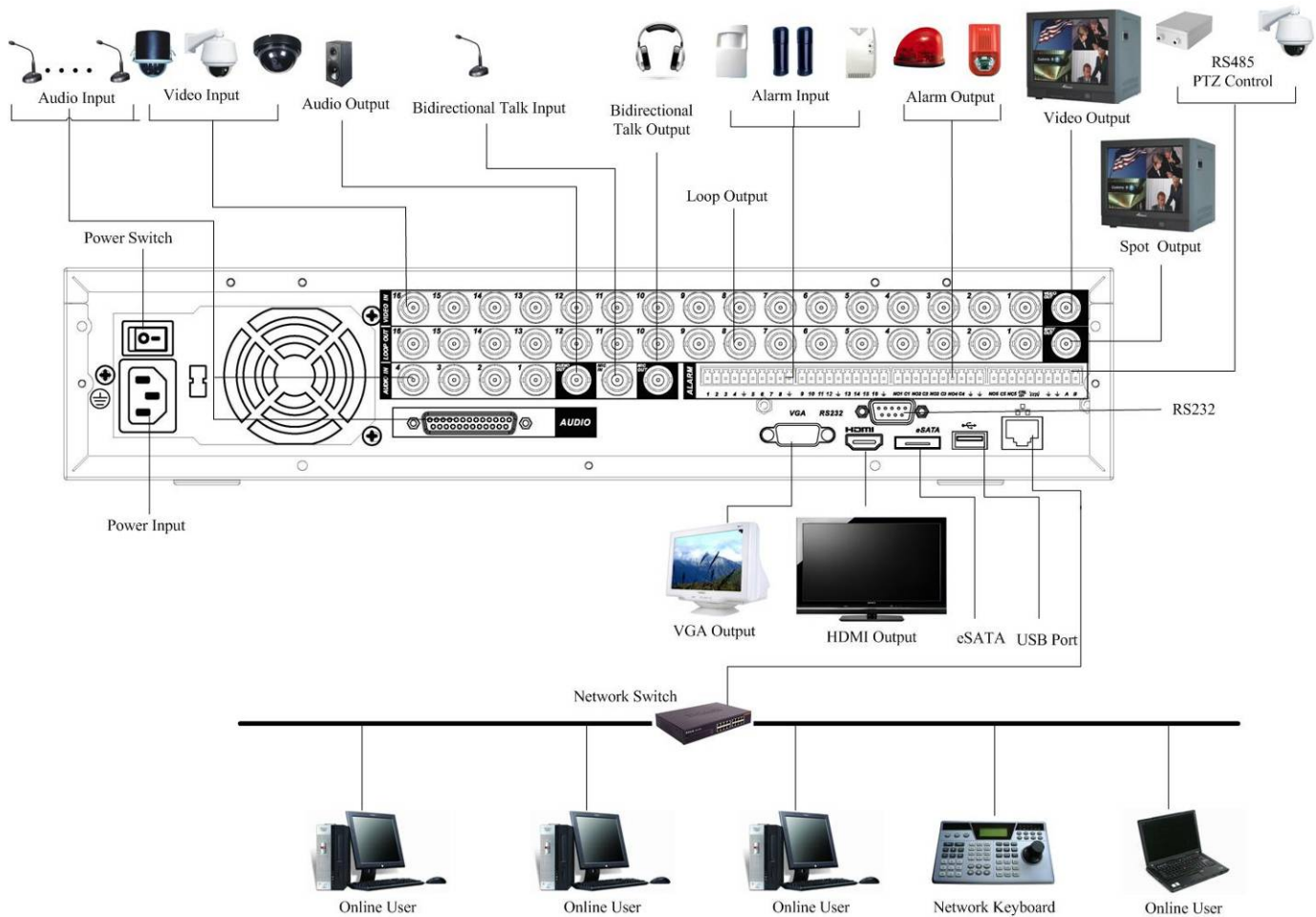

Figure 2-24

2.3.4 HD-SDI 1080P 2U Series

Please refer to the following figure for detailed information. See Figure 2-25.

The following figure is based on the 4-channel series product.

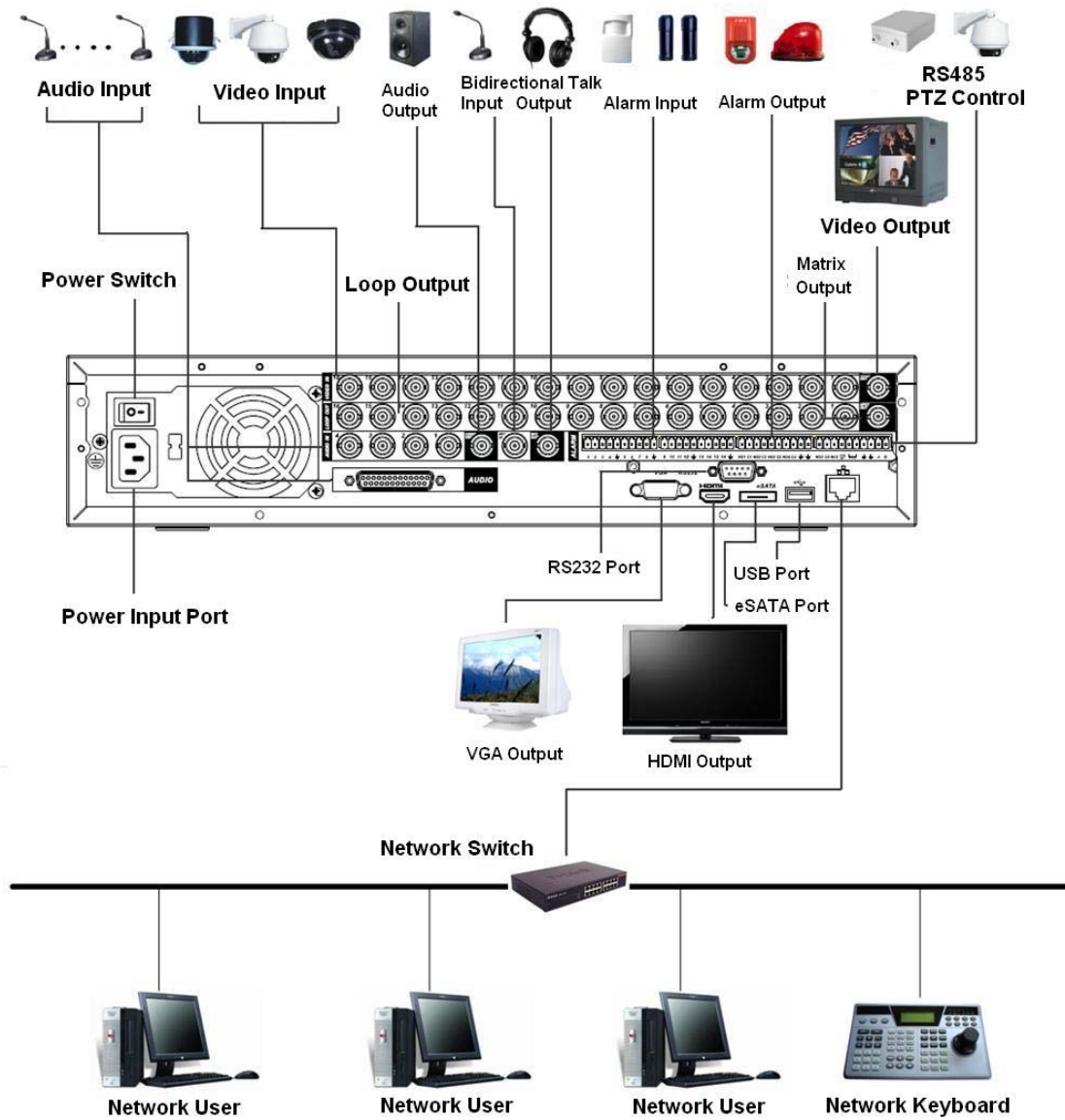

Figure 2-25

2.3.4 960H 2U Series

Please refer to the following figure for detailed information. See Figure 2-26.

The following figure is based on the 16-channel series product.

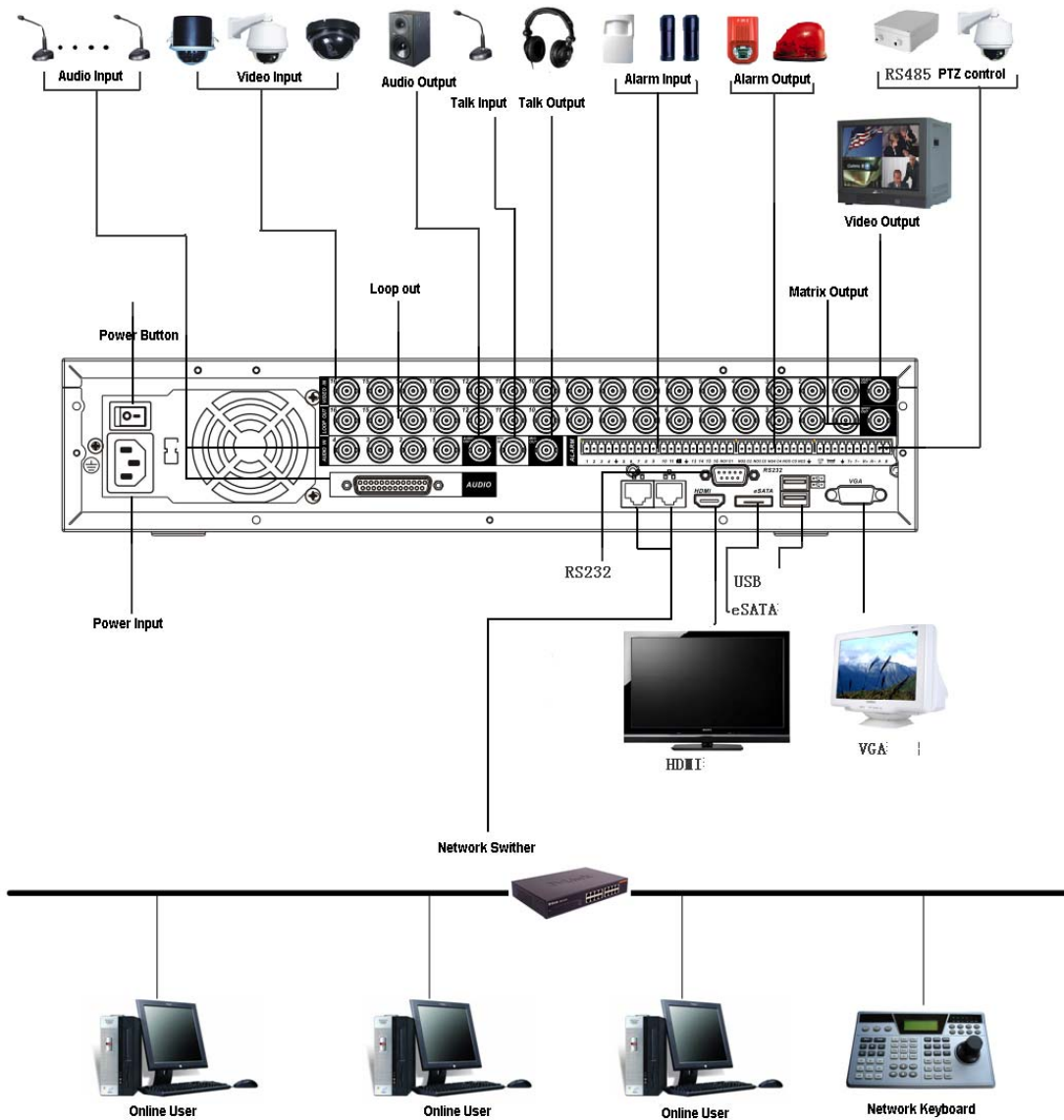

Figure 2-26

2.4 Remote Control

The remote control interface is shown as in Figure 2-27.

Please note remote control is not our standard accessory and it is not included in the accessory bag.

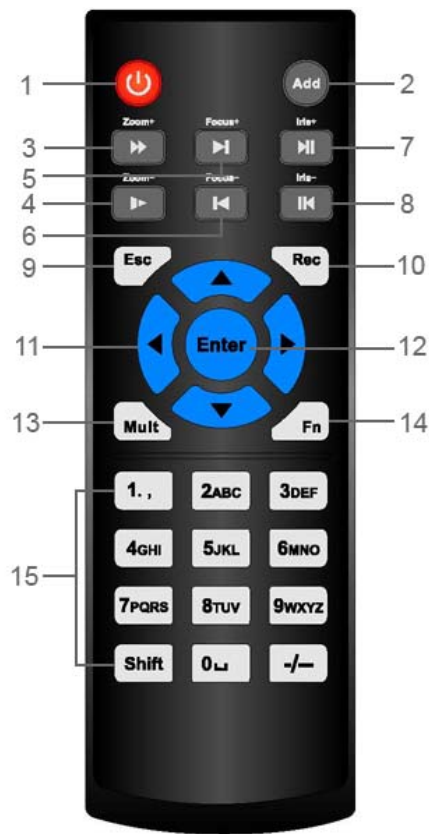

Figure 2-27





Please refer to the following sheet for detailed information.

Serial Number	Name	Function
1	Power button	Click it to boot up or shut down the device.
2	Address	Click it to input device number, so that you can control it.
3	Forward	Various forward speeds and normal speed playback.
4	Slow play	Multiple slow play speeds or normal playback.
5	Next record	In playback mode, playback the next video.
6	Previous record	In playback mode, playback the previous video.
7	Play/Pause	In pause mode, click this button to realize normal playback.
		In normal playback click this button to pause playback.
		In real-time monitor mode, click this button to enter video search menu.
8	Reverse/pause	Reverse playback pause mode, click this button to realize normal playback.
		In reverse playback click this button to pause playback.

9	Cancel	Go back to previous menu or cancel current operation (close upper interface or control)
10	Record	Start or stop record manually In record interface, working with the direction buttons to select the record channel. Click this button for at least 1.5 seconds, system can go to the Manual Record interface.
11	Direction keys	Switch current activated control, go to left or right. In playback mode, it is to control the playback process bar. Aux function(such as switch the PTZ menu)
12	Confirm /menu key	go to default button go to the menu
13	Multiple-window switch	Switch between multiple-window and one-window.
14	Auxiliary key	In 1-ch monitor mode: pop up assistant function: PTZ control and Video color.
		Switch the PTZ control menu in PTZ control interface.
		In motion detection interface, working with direction keys to complete setup.
15	0-9 number key	Input password, channel or switch channel.
		Shift is the button to switch the input method.

2.5 Mouse Control

Left click mouse	System pops up password input dialogue box if you have not logged in. In real-time monitor mode, you can go to the main menu.
	When you have selected one menu item, left click mouse to view menu content.
	Implement the control operation.
	Modify checkbox or motion detection status.
	Click combo box to pop up drop down list

	<p>In input box, you can select input methods. Left click the corresponding button on the panel you can input numeral/English character (small/capitalized). Here ← stands for backspace button. _ stands for space button.</p> <p>In English input mode: _ stands for input a backspace icon and ← stands for deleting the previous character.</p> <div style="display: flex; justify-content: space-around; align-items: center;">   </div> <p>In numeral input mode: _ stands for clear and ← stands for deleting the previous numeral.</p> <p>When input special sign, you can click corresponding numeral in the front panel to input. For example, click numeral 1 you can input“/” , or you can click the numeral in the on-screen keyboard directly.</p> 
Double left click mouse	<p>Implement special control operation such as double click one item in the file list to playback the video.</p> <p>In multiple-window mode, double left click one channel to view in full-window. Double left click current video again to go back to previous multiple-window mode.</p>
Right click mouse	<p>In real-time monitor mode, pops up shortcut menu: one-window, four-window, nine-window and sixteen-window, Pan/Tilt/Zoom, color setting, search, record, alarm input, alarm output, main menu. Among which, Pan/Tilt/Zoom and color setting applies for current selected channel.</p> <p>If you are in multiple-window mode, system automatically switches to the corresponding channel.</p>  <p>Exit current menu without saving the modification.</p>
Press middle button	<p>In numeral input box: Increase or decrease numeral value.</p> <p>Switch the items in the check box.</p> <p>Page up or page down</p>
Move mouse	Select current control or move control
Drag mouse	<p>Select motion detection zone</p> <p>Select privacy mask zone.</p>

2.6 Virtual Keyboard & Front Panel

2.6.1 Virtual Keyboard

The system supports two input methods: numeral input and English character (small and capitalized) input.

Move the cursor to the text column, the text is shown as blue, input button pops up on the right. Click that button to switch between numeral input and English input (capitalized and small), Use > or < to shift between small character and capitalized character.

2.6.2 Front Panel

Move the cursor to the text column. Click Fn key and use direction keys to select number you wanted. Please click enter button to input.

3 Installation and Connections

Note: All the installation and operations here should conform to your local electric safety rules.

3.1 Check Unpacked DVR

When you receive the DVR from the forwarding agent, please check whether there is any visible damage. The protective materials used for the package of the DVR can protect most accidental clashes during transportation. Then you can open the box to check the accessories.

Please check the items in accordance with the list. Finally you can remove the protective film of the DVR.

3.2 About Front Panel and Rear Panel

The model label in the front panel is very important; please check according to your purchase order.

The label in the rear panel is very important too. Usually we need you to represent the serial number when we provide the service after sales.

3.3 HDD Installation

You can refer to the Appendix for recommended HDD brand.

Please follow the instructions below to install hard disk.

3.3.1 1U series

This series DVR has two SATA HDDs. Please use HDD of 7200rpm or higher.



1. Loosen the screws of the upper cover and side panel.

2. Fix four screws in the HDD (Turn just three rounds).

3. Place the HDD in accordance with the four holes in the bottom.

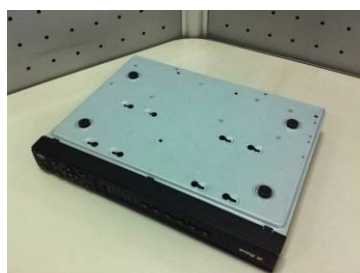

4. Turn the device upside down and then turn the screws in firmly.

5. Fix the HDD firmly.

6. Connect the HDD cable and power cable.



7. Put the cover in accordance with the clip and then place the upper cover back.



8. Secure the screws in the rear panel and the side panel.

3.3.2 1.5U series

This series DVR has four SATA HDDs. Please use HDD of 7200rpm or higher.



1. Loosen the screws of the upper cover.



2. Line up the HDD to the four holes of the HDD bracket.



3. Use four screws to fix HDD.

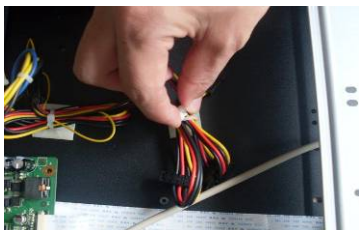

4. Unfasten the HDD power cable.

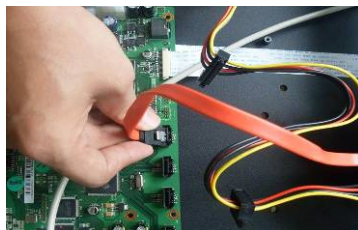

5. Use the special data cable to connect the HDD and the SATA port



6. Insert the HDD power cable. Close the chassis and fix the screws to secure firmly.

3.3.3 2U series (HD-SDI series, 960H)

This series DVR max supports 8 SATA HDDs. Please use HDD of 7200rpm or higher.



1. Loosen the screws of the upper cover.



2. Remove the HDD upper bracket



3. Now you can see the bottom bracket



4. Line up the HDD to the four holes of the HDD bracket.



5. Use screws to fix HDD.



6. Install the upper bracket and then Use screws to fix HDD in the bracket.



7. Unfasten the HDD power cable.

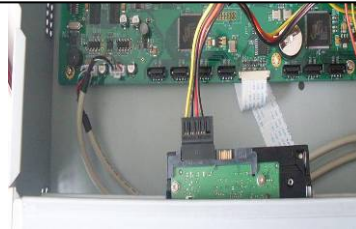

8. Insert the HDD power cable.

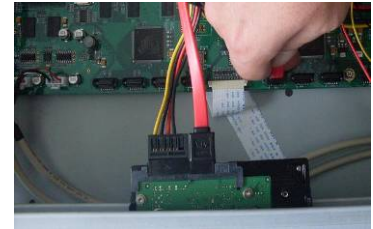

9. Use the special data cable to connect the HDD and the SATA port. Close the chassis and fix the screws to secure firmly.

Important:

If the HDD amount is less than four, you do not need to install the HDD bracket.
When there is a bracket, please make sure the installation direction of HDDs is the same.

3.4 Rack Installation

Please note this installation mode is for 1.5U/2U series product.
Please follow the steps listed below.

- Use twelve screws to fix the unit
- Please make sure the indoor temperature is below 35°C (95°F).
- Please make sure there is 15cm (6 inches) space around the device to guarantee sound ventilation.
- Please install from the bottom to the top.
- If there are more accessories connected in the rack, please take precaution measures in case the rack power is overload.

3.5 Connecting Power Supply

Please check input voltage and device power button match or not.
We recommend you use UPS to guarantee steady operation, DVR life span, and other peripheral equipments operation such as cameras.

3.6 Connecting Video Input and Output Devices

3.6.1 Connecting Video Input

The video input interface is BNC. The input video format includes: PAL/NTSC BNC (1.0V_{P-P}, 75Ω) ; For HD-SDI series product: BNC (0.8VP-P, 75Ω)

The video signal should comply with your national standards.

The input video signal shall have high SNR, low distortion; low interference, natural color and suitable lightness.

Guarantee the stability and reliability of the camera signal:

The camera shall be installed in a cool, dry place away from direct sunlight, inflammable, explosive substances and etc.

The camera and the DVR should have the same grounding to ensure the normal operation of the camera.

Guarantee stability and reliability of the transmission line

Please use high quality, sound shielded BNC. Please select suitable BNC model according to the transmission distance.

If the distance is too long, you should use twisted pair cable, and you can add video compensation devices or use optical fiber to ensure video quality.

You should keep the video signal away from the strong electromagnetic interference, especially the high tension current.

Keep connection lugs in well contact

The signal line and shielded wire should be fixed firmly and in well connection. Avoid dry joint, lap welding and oxidation.

3.6.2 Connecting Video Output

Video output includes a BNC(PAL/NTSC1.0V_{P-P}, 75Ω) output ,a VGA output and HDMI output. System supports BNC, VGA and HDMI output at the same time.

When you are using pc-type monitor to replace the monitor, please pay attention to the following points:

- To defer aging, do not allow the pc monitor to run for a long time.
- Regular demagnetization will keep device maintain proper status.
- Keep it away from strong electromagnetic interference devices.

Using TV as video output device is not a reliable substitution method. You also need to reduce the working hour and control the interference from power supply and other devices. The low quality TV may result in device damage.

3.7 Connecting Audio Input & Output, Bidirectional Audio

3.7.1 Audio Input

These series products audio input port adopt BNC port.

Due to high impedance of audio input, please use active sound pick-up.

Audio transmission is similar to video transmission. Try to avoid interference, dry joint, loose contact and it shall be away from high tension current.

3.7.2 Audio Output

The audio output signal parameter is usually over 200mv 1KΩ (BNC). It can directly connect to low impedance earphone, active sound box or amplifier-drive audio output device.

If the sound box and the pick-up cannot be separated spatially, it is easy to arouse squeaking. In this case you can adopt the following measures:

- Use better sound pick-up with better directing property.
- Reduce the volume of the sound box.
- Using more sound-absorbing materials in decoration can reduce voice echo and improve acoustics environment.
- Adjust the layout to reduce happening of the squeaking.

3.8 Alarm Input and Output Connection

Please refer to the following sheet for alarm input and output connection.

There are two alarm input types for you to select: normal open (NO) and normal close (NC).

1. Alarm input

- Please make sure alarm input mode is grounding alarm input.
- Grounding signal is needed for alarm input.
- Alarm input needs the low level voltage signal.
- Alarm input mode can be either NC (normal Open) or NO (Normal Close)
- When you are connecting two DVRs or you are connecting one DVR and one other device, please use a relay to separate them,

2. Alarm output

The alarm output port should not be connected to high power load directly (It shall be less than 1A) to avoid high current which may result in relay damage. Please use the co contactor to realize the connection between the alarm output port and the load.

3. How to connect PTZ decoder

- Ensure the decoder has the same grounding with DVR, otherwise you may not control the PTZ. Shielded twisted wire is recommended and the shielded layer is used to connect to the grounding.
- Avoid high voltage. Ensure proper wiring and some thunder protection measures.
- For too long signal wires, 120Ω should be parallel connected between A, B lines on the far end to reduce reflection and guarantee the signal quality.
- “485 A, B” of DVR cannot parallel connect with “485 port” of other device.
- The voltage between of A,B lines of the decoder should be less than 5v.

4. Please make sure the front-end device has soundly earthed.

Improper grounding may result in chip damage.

3.8.1 Alarm Input and Output Details

You can refer to the following sheet for alarm input and output information.

Important

Please refer to the specifications for the alarm input and output channel amount. Do not merely count the alarm input and out channel amount according to the ports on the rear panel.

3.8.1.1 General 1U Series

The 4/8-channel series product interface is shown as below. See Figure 3-1.

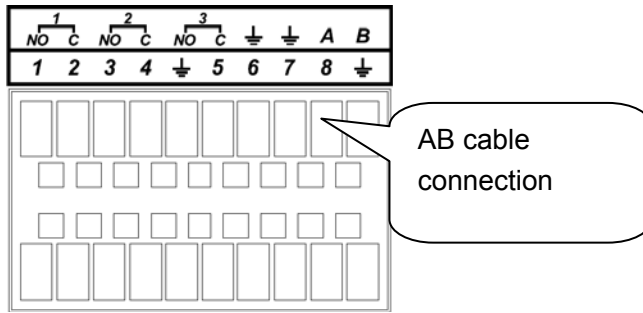



Figure 3-1

Please refer to the following sheet and Figure 3-1 for detailed information.

In the second line, from the left to the right: 1, 2, 3, 4, 5, 6, 7, 8.	ALARM 1 to ALARM 8. The alarm becomes active in low voltage.
In the first line, from the left to the right: 1-NO C, 2-NO C, 3-NO C	There are three groups of normal open activation output (on/off button)
	Earth cable.
485 A/B	485 communication port. They are used to control devices such as PTZ. Please parallel connect 120TΩ between A/B cables if there are too many PTZ decoders.

The 16-channel interface is shown as in Figure 3-2.

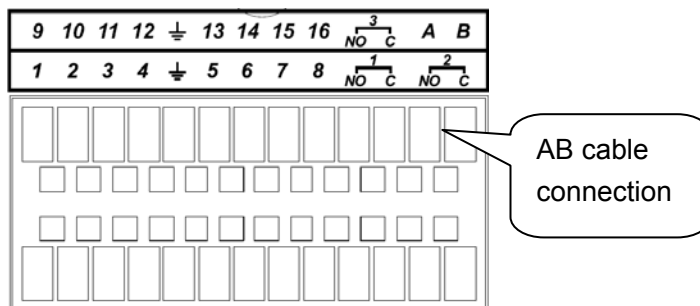



Figure 3-2

Please refer to the following sheet and Figure 3-2 for detailed information.

In the second line, from the left to the right: 1, 2, 3, 4, 5, 6, 7, 8. and the first line from the left to the right : 9, 10, 11, 12, 13, 14, 15, 16	ALARM 1 to ALARM 16. The alarm becomes active in low voltage.
In the first line, from the left to the right: 3-NO C, and the second line from the left to the right 1-NO C, 2-NO C.	There are three groups of normal open activation output (on/off button)
	Earth cable.

485 A/B	485 communication port. They are used to control devices such as PTZ. Please parallel connect 120TΩ between A/B cables if there are too many PTZ decoders.
---------	--

3.8.1.2 960H 1U Series

The interface is shown as below. See Figure 3-3.

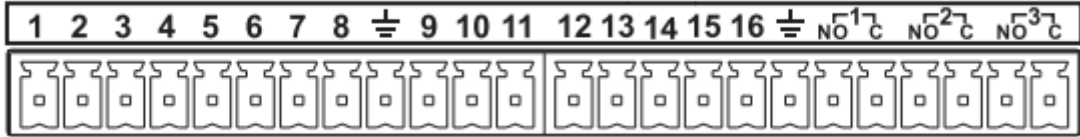

Figure 3-3

Please refer to the following sheet and Figure 3-3 for detailed information.

1, 2, 3, 4, 5, 6, 7, 8, 9, 10, 11, 12, 13, 14, 15, 16	ALARM 1 to ALARM 8. The alarm becomes active in low voltage.
NO1 C1, NO2 C2, NO3 C3	There are three groups of normal open activation output (on/off button)
	Earth cable.

3.8.1.3 Full-D1 1.5U and Simple 1.5U Series

The 1.5U series product interface is shown as in Figure 3-4.

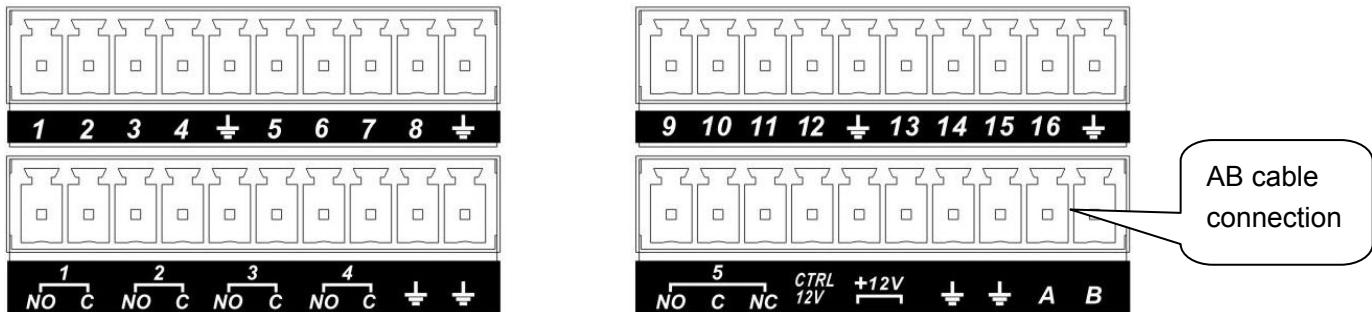



Figure 3-4

You can refer to the following sheet and Figure 3-4 for alarm input and output information.

In the first line, from the left to the right,,: 1, 2, 3, 4, 5, 6, 7, 8, 9, 10, 11, 12, 13, 14, 15, 16	ALARM 1 to ALARM 16. The alarm becomes active in low voltage.
In the second line, from the left to the right: NO1 C1, NO2 C2, NO3 C3, NO4 C4, NO5 C5 NC5	The first four are four groups of normal open activation output (on/off button) NO5 C5 NC5 is a group of NO/NC activation output (on/off button)

CTRL 12V	Control power output. The power output is off when the alarm is canceled.
+12V	It is rated power output.
	Earth cable.
485 A/B	485 communication port. They are used to control devices such as PTZ. Please parallel connect 120TΩ between A/B cables if there are too many PTZ decoders.

3.8.1.4 HD-SDI 1080P 1.5U Series

The HD-SDI 1080P 1.5U series product interface is shown as in Figure 3-5.

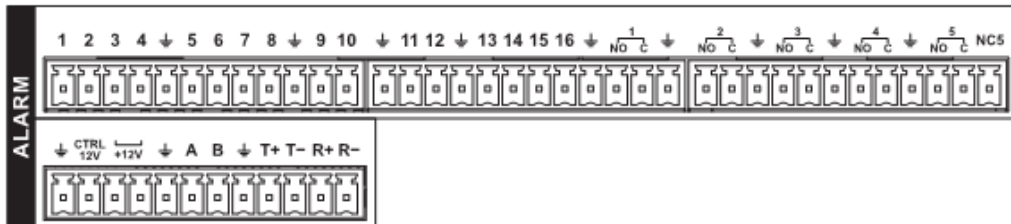



Figure 3-5

You can refer to the following sheet for alarm input and output information.

1, 2, 3, 4, 5, 6, 7, 8, 9, 10, 11, 12, 13, 14, 15, 16	ALARM 1 to ALARM 16. The alarm becomes active in low voltage.
NO1 C1, NO2 C2, NO3 C3, NO4 C4, NO5 C5 NC5	The first four are four groups of normal open activation output (on/off button) NO5 C5 NC5 is a group of NO/NC activation output (on/off button)
CTRL 12V	Control power output. The power output is off when the alarm is canceled.
+12V	It is rated power output.
	Earth cable.
485 A/B	485 communication port. They are used to control devices such as PTZ. Please parallel connect 120TΩ between A/B cables if there are too many PTZ decoders.
T+, T-, R+, R-	4-pin full-duplex RS485 port. T+, T- are the output cable and R+, R- are input cable.

3.8.1.5 960H 4HDD 1.5U Series

The 960H 4HDD 1.5U series product interface is shown as in Figure 3-6.

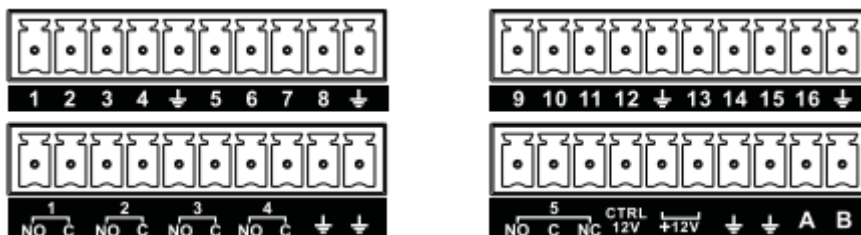



Figure 3-6

You can refer to the following sheet and Figure 3-4 for alarm input and output information.

1, 2, 3, 4, 5, 6, 7, 8, 9, 10, 11, 12, 13, 14, 15, 16	ALARM 1 to ALARM 16. The alarm becomes active in low voltage.
NO1 C1, NO2 C2, NO3 C3, NO4 C4, NO5 C5 NC5	The first four are four groups of normal open activation output (on/off button) NO5 C5 NC5 is a group of NO/NC activation output (on/off button)
CTRL 12V	Control power output. The power output is off when the alarm is canceled.
+12V	It is rated power output.
	Earth cable.
485 A/B	485 communication port. They are used to control devices such as PTZ. Please parallel connect 120Ω between A/B cables if there are too many PTZ decoders.

3.8.1.6 960H 2HDD 1.5U Series

The 960H 2HDD 1.5U series product interface is shown as in Figure 3-7.

The following interface is based on the 16-channel series product.

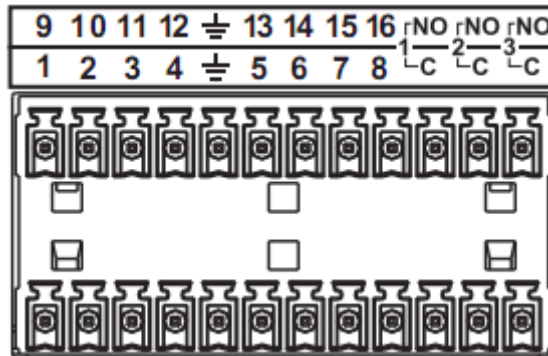



Figure 3-7

You can refer to the following sheet and Figure 3-4 for alarm input and output information.

1, 2, 3, 4, 5, 6, 7, 8, 9, 10, 11, 12, 13, 14, 15, 16	ALARM 1 to ALARM 16. The alarm becomes active in low voltage.
NO1 C1, NO2 C2, NO3 C3,	There are three groups of normal open activation output (on/off button).
	Earth cable.

3.8.1.7 General 2U Series

The general 2U series product interface is shown as in Figure 3-8.

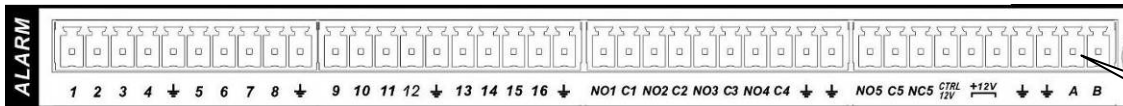



Figure 3-8

You can refer to the following sheet for alarm input and output information.

1, 2, 3, 4, 5, 6, 7, 8, 9, 10, 11, 12, 13, 14, 15, 16	ALARM 1 to ALARM 16. The alarm becomes active in low voltage.
NO1 C1, NO2 C2, NO3 C3, NO4 C4, NO5 C5 NC5	The first four are four groups of normal open activation output (on/off button) NO5 C5 NC5 is a group of NO/NC activation output (on/off button)
CTRL 12V	Control power output. The power output is off when the alarm is canceled.
+12V	It is rated power output.
	Earth cable.
485 A/B	485 communication port. They are used to control devices such as PTZ. Please parallel connect 120TΩ between A/B cables if there are too many PTZ decoders.

3.8.1.8 HD-SDI 1080P 2U Series

HD-SDI 1080P 2U series interface is shown as below. See Figure 3-9.

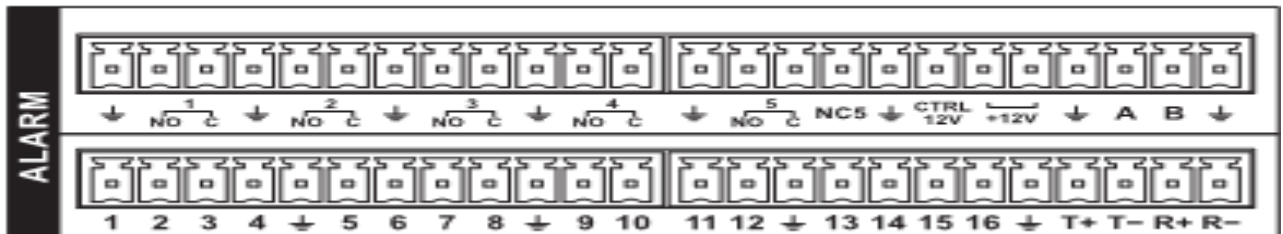



Figure 3-9

You can refer to the following sheet for alarm input and output information.

1, 2, 3, 4, 5, 6, 7, 8, 9, 10, 11, 12, 13, 14, 15, 16	ALARM 1 to ALARM 16. The alarm becomes active in low voltage.
NO1 C1, NO2 C2, NO3 C3, NO4 C4, NO5 C5 NC5	The first four are four groups of normal open activation output (on/off button) NO5 C5 NC5 is a group of NO/NC activation output (on/off button)
CTRL 12V	Control power output. The power output is off when the alarm is canceled.
+12V	It is rated power output.
	Earth cable.
485 A/B	485 communication port. They are used to control devices such as PTZ. Please parallel connect 120TΩ between A/B cables if there are too many PTZ decoders.

T+, T-, R+, R-	4-pin full-duplex RS485 port. T+, T- are the output cable and R+, R- are input cable.
485 A/B	485 communication port. They are used to control devices such as PTZ. Please parallel connect 120TΩ between A/B cables if there are too many PTZ decoders.

3.8.1.9 960H 2U Series

960H 2U series product interface is shown as in Figure 3-10.



Figure 3-10

You can refer to the following sheet for alarm input and output information.

1, 2, 3, 4, 5, 6, 7, 8, 9, 10, 11, 12, 13, 14, 15, 16	ALARM 1 to ALARM 16. The alarm becomes active in low voltage.
NO1 C1, NO2 C2, NO3 C3, NO4 C4, NO5 C5 NC5	The first four are four groups of normal open activation output (on/off button) NO5 C5 NC5 is a group of NO/NC activation output (on/off button)
CTRL 12V	Control power output. The power output is off when the alarm is canceled.
+12V	It is rated power output.
	Earth cable.
T+, T-, R+, R-	4-pin full-duplex RS485 port. T+, T- are the output cable and R+, R- are input cable.
485 A/B	485 communication port. They are used to control devices such as PTZ. Please parallel connect 120TΩ between A/B cables if there are too many PTZ decoders.

3.8.2 Alarm Input Port

Please refer to the following sheet for more information.

- Normal open or Normal close type.
- Please parallel connect COM end and GND end of the alarm detector (Provide external power to the alarm detector).
- Please parallel connect the Ground of the DVR and the ground of the alarm detector.
- Please connect the NC port of the alarm sensor to the DVR alarm input(ALARM)
- Use the same ground with that of DVR if you use external power to the alarm device.

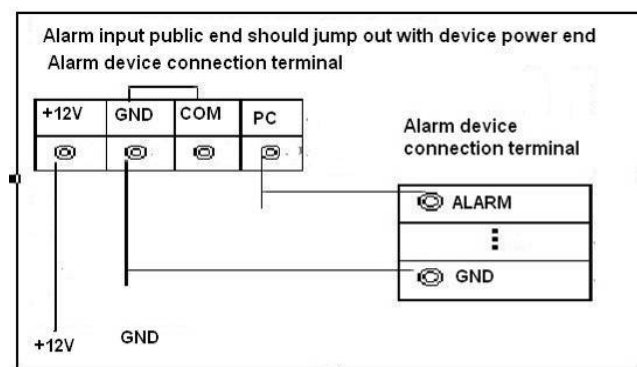

Figure 3-11

3.8.3 Alarm Output Port

- Provide power to peripheral alarm device.
- To avoid overloading, please read the following relay parameters sheet carefully.
- RS485 A/B cable is for the A/B cable of the PTZ decoder.

Relay Specification

Model:	JRC-27F	
Material of the touch	Silver	
Rating (Resistance Load)	Rated switch capacity	30VDC 2A, 125VAC 1A
	Maximum switch power	125VA 160W
	Maximum switch voltage	250VAC, 220VDC
	Maximum switch currenxy	1A
Insulation	Between touches with same polarity	1000VAC 1minute
	Between touches with different polarity	1000VAC 1minute
	Between touch and winding	1000VAC 1minute
Surge voltage	Between touches with same polarity	1500V (10×160us)
Length of open time	3ms max	
Length of close time	3ms max	
Longevity	Mechanical	50×10 ⁶ times (3Hz)
	Electrical	200×10 ³ times (0.5Hz)
Temperature	-40℃ ~+70℃	

3.9 RS232

You can connect the DVR with POS or Keyboard through RS232.

With POS system, the DVR can communicate through RS232 and network. For the POS system, the DVR can integrate the text content and even search the record through the info.

The series DVR also support NKB operation. You can operate the DVR from the keyboard controls instead of using the control pad on the front panel of the unit.

To connect a NKB keyboard to the DVR:

1. Assemble the KBD keyboard according to the instructions in its accompanying installation manual.
2. Connect the KBD keyboard into one of the RS232 ports on the DVR or through network.

3.10 RS485

When the DVR receives a camera control command, it transmits that command up the coaxial cable to the PTZ device. RS485 is a single-direction protocol; the PTZ device can't return any data to the unit. To enable the operation, connect the PTZ device to the RS485 (A,B) input on the DVR. See Figure 3-8.

Since RS485 is disabled by default for each camera, you must enable the PTZ settings first. This series DVRs support multiple protocols such as Pelco-D, Pelco-P.

To connect PTZ devices to the DVR:

1. Connect RS485 A,B on the DVR rear panel.
2. Connect the other end of the cable to the proper pins in the connector on the camera.
3. Please follow the instructions to configure a camera to enable each PTZ device on the DVR.

3.11 Other Interfaces

There are still other interfaces on the DVR, such as USB ports. You can refer to the Figure 3-12 for more information.

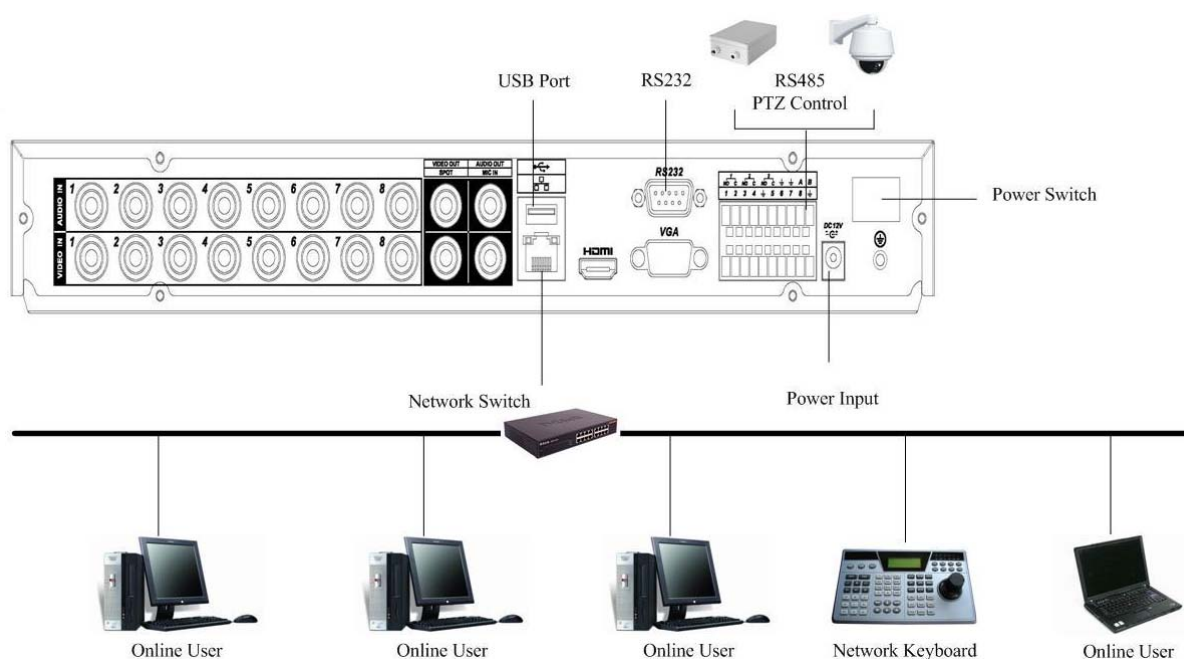

1U series

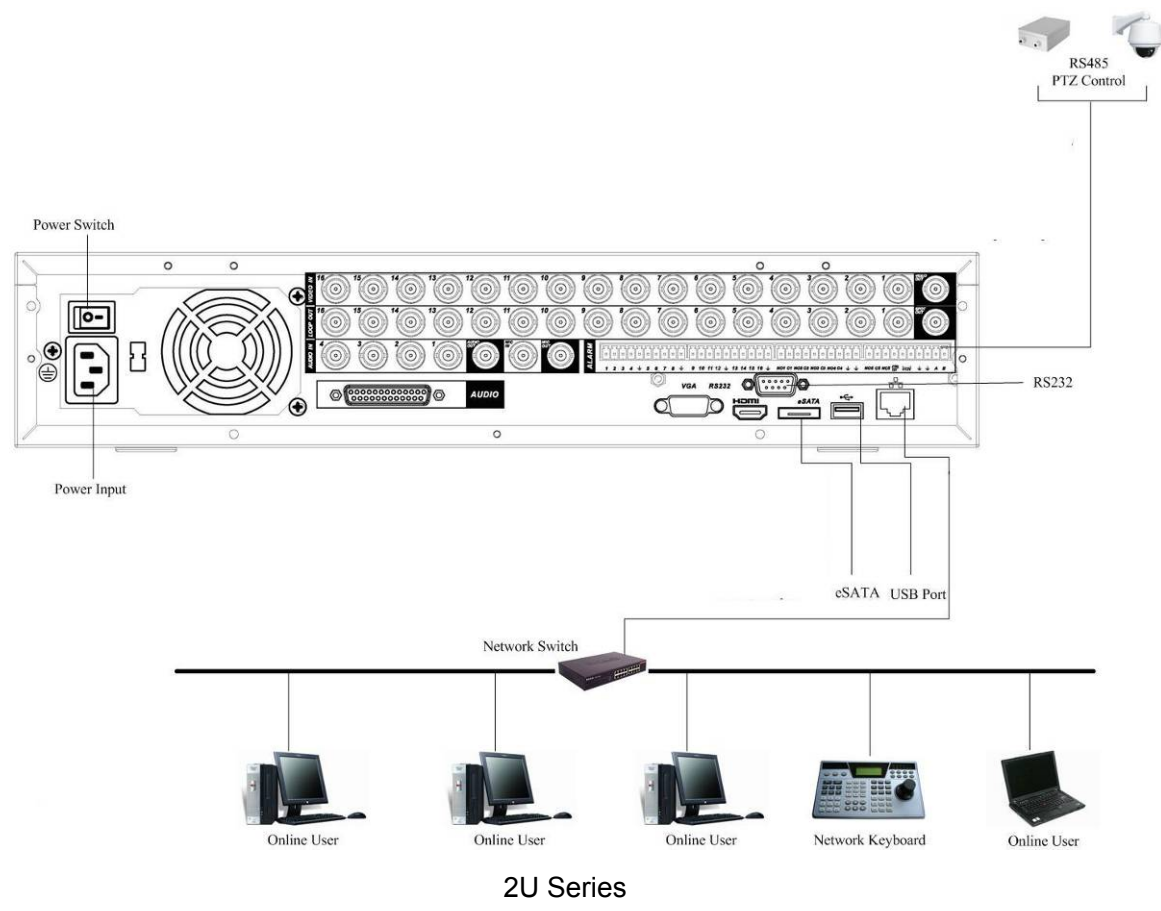
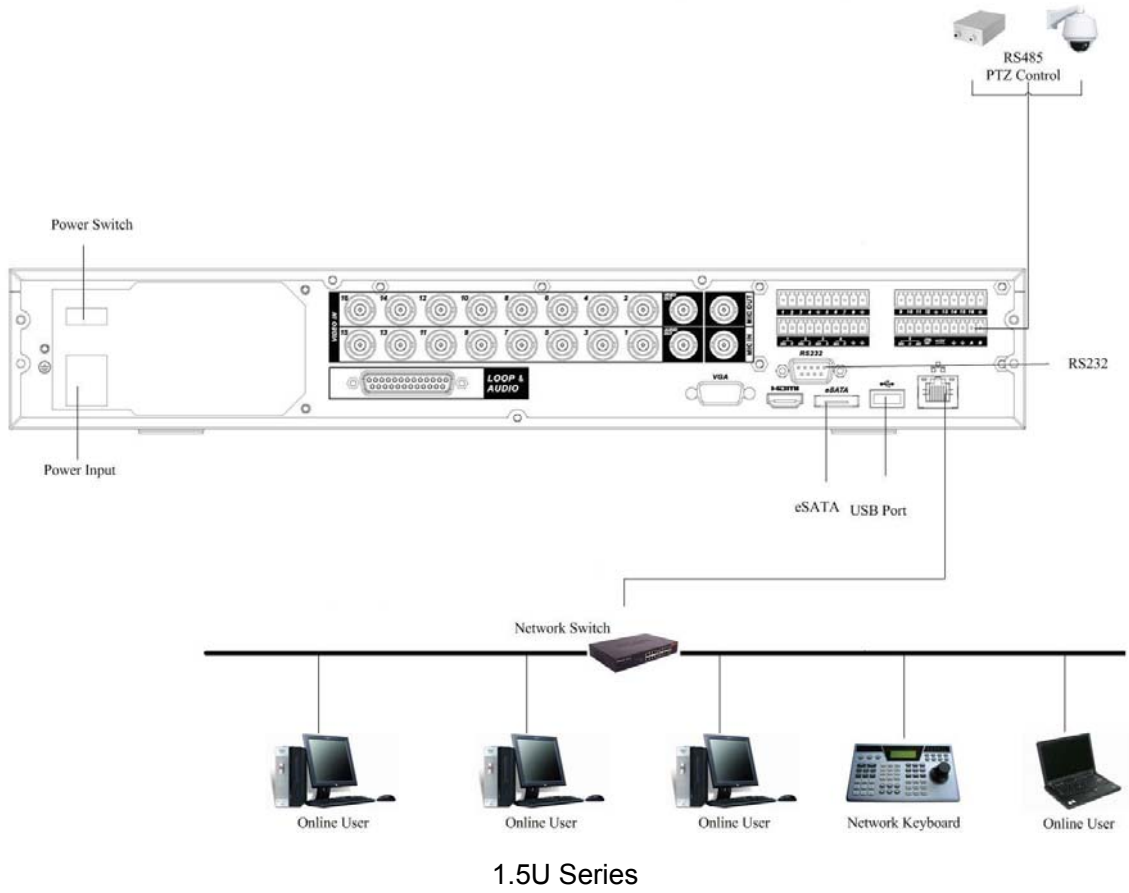

Figure 3-12

4 Overview of Navigation and Controls

Note:

All the operations listed below are based on the 2U series product.

Before operation, please make sure:

- You have properly installed HDD and all the cable connections.
- The provided input power and the device power are matched.
- The external power shall be DC 12V (For 1U series product only) or AC90~264V 50+2% Hz. For 1.5U and 2U series product).
- Always use the stable current, if necessary UPS is a best alternative measure.

4.1 Login, Logout & Main Menu

4.1.1 Login

After system booted up, system pops up the startup wizard.

Click the Cancel button; you can go to the system login interface.

Click the Next Step button; you can go to the startup wizard interface. Here you can set the system basic information. See Figure 4-1.



Figure 4-1

The system login interface is shown as in Figure 4-2.

System consists of four accounts:

- **Username:** admin. **Password:** admin. (administrator, local and network)
- **Username:** 888888. **Password:** 888888. (administrator, local only)
- **Username:** 666666. **Passwords:** 666666 (Lower authority user who can only monitor, playback, backup and etc.)
- **Username:** default. **Password:** default (hidden user)

You can use USB mouse, front panel, or keyboard to input. About input method: Click  to switch between numeral, English character (small/capitalized) and denotation.

Note:

For security reason, please modify password after you first login.

Within 30 minutes, three times login failure will result in system alarm and six times login failure will result in account lock!



Figure 4-2

4.1.2 Main Menu

After you logged in, the system main menu is shown as below. See Figure 4-3.

There are total six icons: search, information, setting, backup, advanced and shutdown.

You can move the cursor to highlight the icon, and then double click mouse to enter the sub-menu.

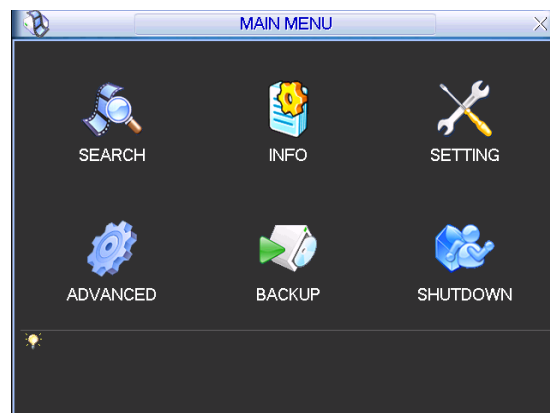

Figure 4-3

4.1.3 Logout

There are two ways for you to log out.

One is from menu option:

In the main menu, click shutdown button, you can see an interface is shown as below. See Figure 4-4.

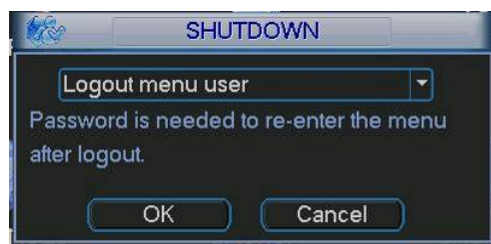

Figure 4-4

There are several options for you. See Figure 4-5.

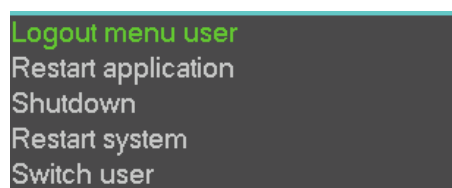

Figure 4-5

The other ways is to press power button on the front panel for at least 3 seconds, system will stop all operations. Then you can click the power button in the rear panel to turn off the DVR.

4.1.4 Auto Resume after Power Failure

The system can automatically backup video and resume previous working status after power failure.

4.1.5 Replace Button Battery

Please make sure to use the same battery model if possible.





We recommend replace battery regularly (such as one-year) to guarantee system time accuracy.

Note:

Before replacement, please save the system setup, otherwise, you may lose the data completely!

4.2 Live Viewing

After you logged in, the system is in live viewing mode. You can see system date, time and channel name. If you want to change system date and time, you can refer to general settings (Main Menu->Setting->General). If you want to modify the channel name, please refer to the display settings (Main Menu->Setting->Display).

1		Recording status	3		Video loss
2		Motion detection	4		Camera lock

Preview Control

The preview control function has the following features.

- Support preview playback.
 - ✧ In the preview desktop, system can playback previous 5-60 minutes record of current channel. Please go to the Main Menu->General to set real-time playback time.
 - ✧ Support drag and play function. You can use your mouse to select any playback start time.
 - ✧ Support playback, pause and exit function.
 - ✧ Right now, system does not support slow playback and backward playback function.
- Support digital zoom function.
- Support real-time backup function.

You can follow the contents listed below for the operation instruction.





Preview control interface

Move you mouse to the top centre of the video of current channel, you can see system pops up the preview control interface. See Figure 4-6. If your mouse stays in this area for more than 6 seconds and has no operation, the control bar automatically hides.



Figure 4-6

You can refer to the following sheet for detailed information.

SN	Name	Function
1	Realtime playback	It is to playback the previous 5-60 minutes record of current channel. Please go to the Main Menu->General to set real-time playback time. System may pop up a dialogue box if there is no such record in current channel.
2	Digital zoom	It is to zoom in specified zone of current channel. It supports zoom in function of multiple-channel. The selected area has an icon as  and the free area is shown as an icon as  .
3	Real-time backup function	It is to backup the video of current channel to the USB device. System can not backup the video of multiple-channel at the same time. Current selected backup channel has an icon as  and the free channel is shown as an icon as  . Once the backup started, you can see the free channel is shown as an icon as  .
4	Exit	

Playback control

The playback control has the following features.

- Support play, pause, and exit and drag function.
- During the preview playback process, you can not see the channel title and record status of current channel. It will display the channel title and the record status once you exit the preview playback.
- During the preview playback, you can not switch the displayed channel or change current window-display mode.
- Please note, the tour function has the higher priority than the preview playback. System automatically exits the preview playback function and its corresponding interface when the tour function started. You can not control the preview playback until the tour function ended.

4.3 Manual Record

Note:

You need to have proper rights to implement the following operations. Please make sure the HDD has been properly installed.

4.3.1 Manual record menu

There are two ways for you to go to manual record menu.

- Right click mouse or in the main menu, Advanced->Manual Record.
- In live viewing mode, click record button in the front panel or record button in the remote control.

Manual record menu is shown as in Figure 4-7.

4.3.2 Basic operation

There are three statuses: schedule/manual/stop. Please highlight icon “○” to select corresponding channel.

- Manual: The highest priority. After manual setup, all selected channels will begin ordinary recording.
- Schedule: Channel records as you have set in recording setup (Main Menu->Setting->Schedule)
- Stop: All channels stop recording.

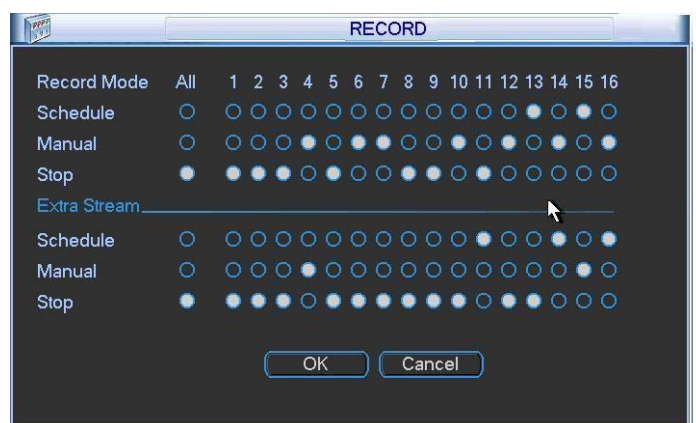

Figure 4-7

4.3.3 Enable/disable record

Please check current channel status: “○” means it is not in recording status, “●” means it is in recording status.

You can use mouse or direction key to highlight channel number. See Figure 4-8.

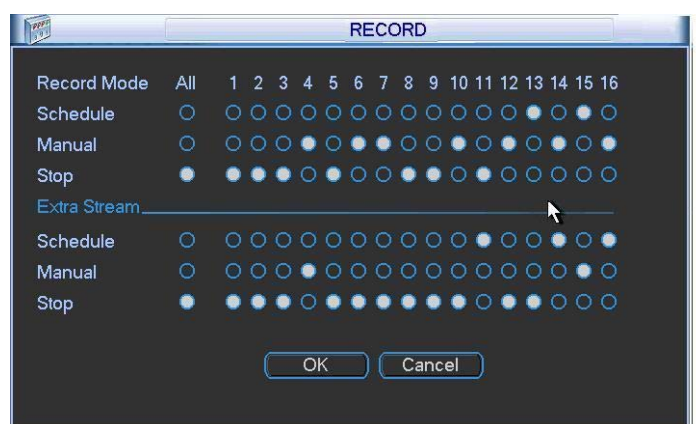

Figure 4-8

4.3.4 Enable all channel recording

Highlight ○ below All, you can enable all channel recording.

- All channel schedule record

Please highlight “ALL” after “Schedule”. See Figure 4-9.

When system is in schedule recording, all channels will record as you have previously set (Main menu->Setting->Schedule).

The corresponding indication light in front panel will turn on.

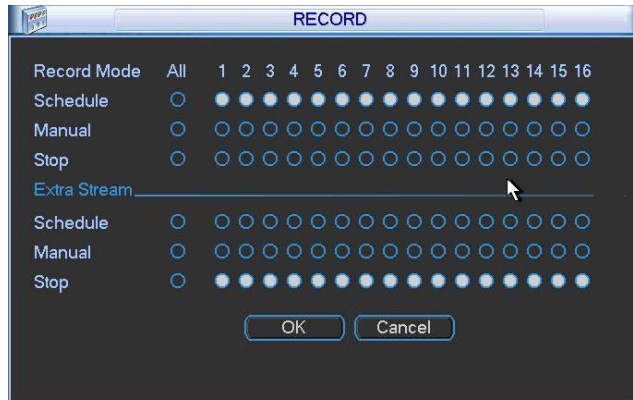

Figure 4-9

- All channel manual record

Please highlight “ALL” after “Manual.” See Figure 4-10.

When system is in manual recording, all scheduled set up you have set in will be null ((Main menu->Setting->Schedule)).

You can see indication light in front panel turns on, system begins manual record now.

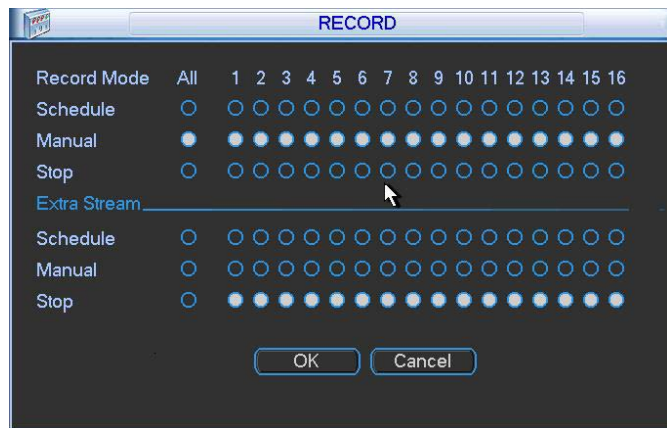

Figure 4-10

4.3.5 Stop all channel recording

Please highlight “ALL” after “Stop”. See Figure 4-11.

System stops all channel recording no matter what mode you have set in the menu (Main menu->Setting->Schedule)

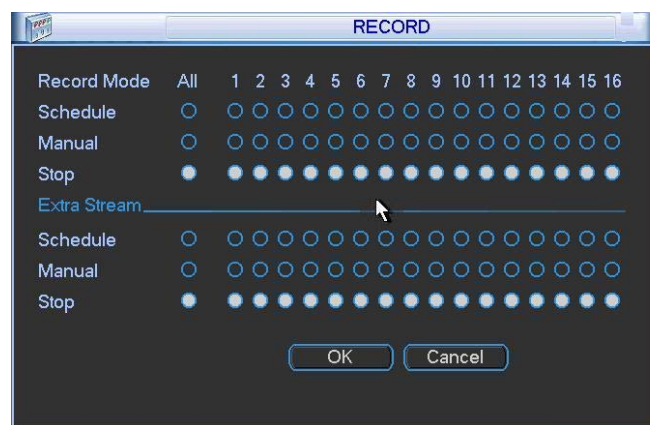

Figure 4-11

4.4 Search & Playback

Click search button in the main menu, search interface is shown as below. See Figure 4-12.

Usually there are three file types:

- R: Regular recording file.
- A: External alarm recording file.
- M: Motion detection recording file.

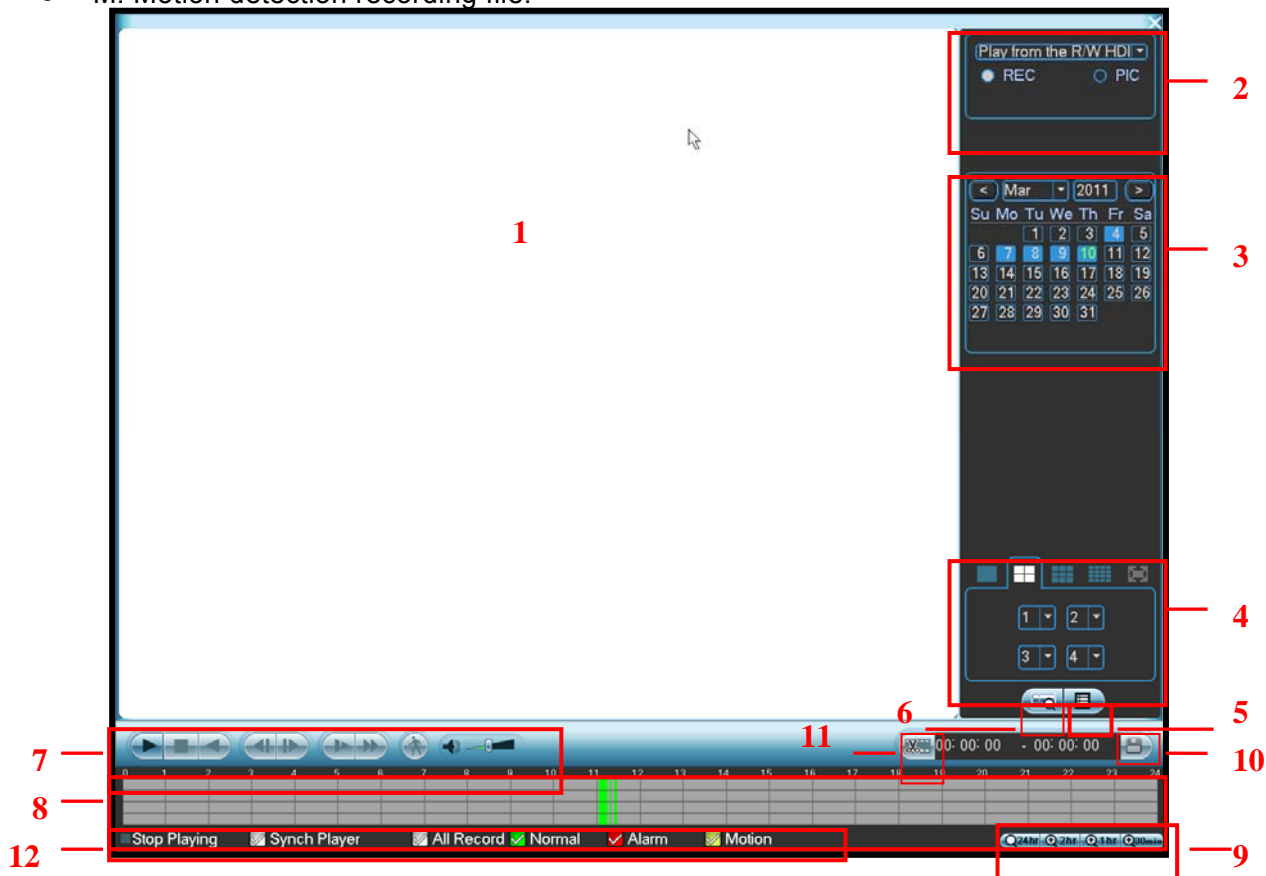



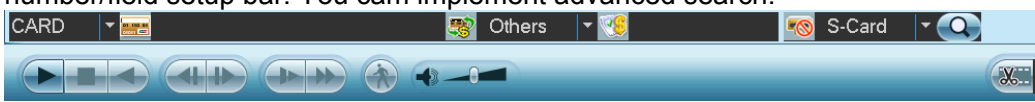







































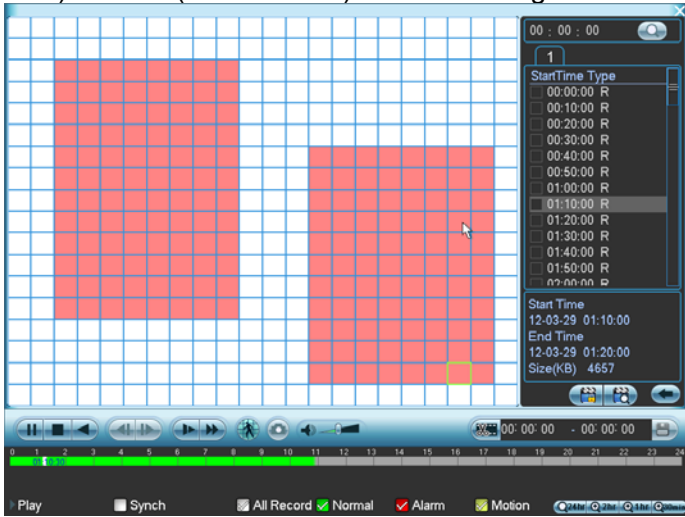



Figure 4-12

Please refer to the following sheet for more information.

SN	Name	Function
1	Display window	<ul style="list-style-type: none"> ●Here is to display the searched picture or file. ●Support 1/4/9/16-window playback.
2	Search type	<ul style="list-style-type: none"> ●Here you can select to search the picture or the recorded file. ●You can select to play from the read-write HDD or the connected external device.
3	Calendar	<ul style="list-style-type: none"> ●The blue highlighted date means there is picture or file. Otherwise, there is no picture or file. ●In any play mode, click the date you want to see, you can see the corresponding record file trace in the time bar.
4	Playback mode and channel selection pane.	<ul style="list-style-type: none"> ●Playback mode: 1/4/9/16. (It may vary due to different series.) ◇ In 1-window playback mode: you can select 1-16 channels. ◇ In 4-window playback mode: you can select 4 channels according to your requirement. ◇ In 9-window playback mode, you can switch between 1-8 and 9-16 channels. ◇ In 16-window playback mode, you can switch between 1-16 and 17-32 channels. ●The time bar will change once you modify the playback mode or the channel

		option.																				
5	File list switch button	<ul style="list-style-type: none"> ●Double click it, you can view the picture/record file list of current day. ●The file list is to display the first channel of the record file. ●The system can display max 128 files in one time. Use the ▲/▼ or the mouse to view the file. Select one item, and then double click the mouse or click the ENTER button to playback. ●You can input the period in the following interface to begin accurate search. ●File type: R—regular record; A—external alarm record; M—Motion detect record.  <ul style="list-style-type: none"> ●Lock file. Click the file you want to lock and click the button  to lock. The file you locked will not be overwritten. ●Search locked file: Click the button  to view the locked file. ●Return: Click button , system goes back to the calendar and channel setup interface. <p>Please note:</p> <ul style="list-style-type: none"> ●System max locks 16 files. The size of the locked file shall be less than the 1/4 of the HDD total space. The first 16G of each partition can not be locked. ●System can only lock one file at one time and can not lock the extra stream. For the file that is writing or overwriting, it can not be locked. 																				
6	Card number search	<p>The card number search interface is shown as below. Here you can view card number/field setup bar. You can implement advanced search.</p> 																				
7	Playback control pane.	<table border="1"> <tr> <td></td> <td> <p>Play/Pause There are three ways for you to begin playback.</p> <ul style="list-style-type: none"> ● The play button ● Double click the valid period of the time bar. ● Double click the item in the file list. <p>In slow play mode, click it to switch between play/pause.</p> </td> </tr> <tr> <td></td> <td> <p>Stop</p> </td> </tr> <tr> <td></td> <td> <p>Backward play In normal play mode, left click the button, the file begins backward play. Click it again to pause current play. In backward play mode, click  to restore normal play.</p> </td> </tr> <tr> <td></td> <td> <p>In playback mode, click it to play the next or the previous section. You can click continuously when you are watching the files from the same channel. In normal play mode, when you pause current play, you can click  and  to begin frame by frame playback. In frame by frame playback mode, click  to restore normal playback.</p> </td> </tr> <tr> <td></td> <td> <p>Slow play In playback mode, click it to realize various slow play modes such as slow play 1, slow play 2, and etc.</p> </td> </tr> <tr> <td></td> <td> <p>Fast forward In playback mode, click to realize various fast play modes such as fast play 1, fast play 2 and etc.</p> </td> </tr> <tr> <td colspan="2"> <p>Note: The actual play speed has relationship with the software version.</p> </td> </tr> <tr> <td></td> <td> <p>Smart search</p> </td> </tr> <tr> <td></td> <td> <p>The volume of the playback</p> </td> </tr> <tr> <td></td> <td> <p>Click the snapshot button in the full-screen mode, the system can snapshot</p> </td> </tr> </table>		<p>Play/Pause There are three ways for you to begin playback.</p> <ul style="list-style-type: none"> ● The play button ● Double click the valid period of the time bar. ● Double click the item in the file list. <p>In slow play mode, click it to switch between play/pause.</p>		<p>Stop</p>		<p>Backward play In normal play mode, left click the button, the file begins backward play. Click it again to pause current play. In backward play mode, click  to restore normal play.</p>		<p>In playback mode, click it to play the next or the previous section. You can click continuously when you are watching the files from the same channel. In normal play mode, when you pause current play, you can click  and  to begin frame by frame playback. In frame by frame playback mode, click  to restore normal playback.</p>		<p>Slow play In playback mode, click it to realize various slow play modes such as slow play 1, slow play 2, and etc.</p>		<p>Fast forward In playback mode, click to realize various fast play modes such as fast play 1, fast play 2 and etc.</p>	<p>Note: The actual play speed has relationship with the software version.</p>			<p>Smart search</p>		<p>The volume of the playback</p>		<p>Click the snapshot button in the full-screen mode, the system can snapshot</p>
	<p>Play/Pause There are three ways for you to begin playback.</p> <ul style="list-style-type: none"> ● The play button ● Double click the valid period of the time bar. ● Double click the item in the file list. <p>In slow play mode, click it to switch between play/pause.</p>																					
	<p>Stop</p>																					
	<p>Backward play In normal play mode, left click the button, the file begins backward play. Click it again to pause current play. In backward play mode, click  to restore normal play.</p>																					
	<p>In playback mode, click it to play the next or the previous section. You can click continuously when you are watching the files from the same channel. In normal play mode, when you pause current play, you can click  and  to begin frame by frame playback. In frame by frame playback mode, click  to restore normal playback.</p>																					
	<p>Slow play In playback mode, click it to realize various slow play modes such as slow play 1, slow play 2, and etc.</p>																					
	<p>Fast forward In playback mode, click to realize various fast play modes such as fast play 1, fast play 2 and etc.</p>																					
<p>Note: The actual play speed has relationship with the software version.</p>																						
	<p>Smart search</p>																					
	<p>The volume of the playback</p>																					
	<p>Click the snapshot button in the full-screen mode, the system can snapshot</p>																					

		1 picture per second.
8	Time bar	<ul style="list-style-type: none"> ●It is to display the record type and its period in current search criteria. ●In 4-window playback mode, there are corresponding four time bars. In other playback mode, there is only one time bar. ●Use the mouse to click one point of the color zone in the time bar, system begins playback. ●The time bar is beginning with 0 o'clock when you are setting the configuration. The time bar zooms in the period of the current playback time when you are playing the file. ●The green color stands for the regular record file. The red color stands for the external alarm record file. The yellow stands for the motion detect record file.
9	Time bar unit	<ul style="list-style-type: none"> ●The option includes: 24H, 12H, 1H and 30M. The smaller the unit, the larger the zoom rate. You can accurately set the time in the time bar to playback the record. ●The time bar is beginning with 0 o'clock when you are setting the configuration. The time bar zooms in the period of the current playback time when you are playing the file.
10	Backup	Select the file(s) you want to backup from the file list. System max supports files from four channels. Then click the backup button, now you can see the backup menu. Click the start button to begin the backup operation. Check the file again you can cancel current selection. System max supports to display 32 files from one channel.
11	Clip	<ul style="list-style-type: none"> ●It is to edit the file. ●Please play the file you want to edit and then click this button when you want to edit. You can see the corresponding slide bar in the time bar of the corresponding channel. You can adjust the slide bar or input the accurate time to set the file end time. Click this button again and then save current contents in a new file. .
12	Record type	In any play mode, the time bar will change once you modify the search type.
13	Smart search	<p>Click the  button, system begins smart search. System supports 396(22*18 PAL) and 330(22*15 NTSC) zones. See Figure 4-13.</p>  <p style="text-align: center;">Figure 4-13</p> <p>Click the , you can go to the smart search playback. Click it again, system stops smart search playback.</p> <p>Please note:</p> <ul style="list-style-type: none"> ● When system is playing, you can select a zone in the window to begin motion detect. Click the motion detect button to begin play. ● Once the motion detect play has begun, click button again will terminate current motion detect file play. ● The system will take the whole play zone as the motion detect region by

		<p>default.</p> <ul style="list-style-type: none"> ● If you select to play other file in the file list, system switches to motion detect play pf other file. ● During the motion detect play process, you can not implement operations such as change time bar, begin backward playback or frame by frame playback. . <p>Important System does not support motion detect zone setup during the full-screen mode.</p>
Other Functions		
14	Other channel synchronization switch to play when playback	When playing the file, click the number button, system can switch to the same period of the corresponding channel to play.
15	Digital zoom	When the system is in full-screen playback mode, left click the mouse in the screen. Drag your mouse in the screen to select a section and then left click mouse to realize digital zoom. You can right click mouse to exit.

Note:

All the operations here (such as playback speed, channel, time and progress) have relationship with hardware version. Some series DVRs do not support some functions or playback speeds.

4.5 Schedule

After system booted up, it is in default 24-hour regular mode. You can set record type and time in schedule interface.

4.5.1 Schedule Menu

In the main menu, from setting to schedule, you can go to schedule menu. See Figure 4-14.

- Channel: Please select the channel number first. You can select “all” if you want to set for the whole channels.
- Week day: There are eight options: ranges from Saturday to Sunday and all.
- Pre-record: System can pre-record the video before the event occurs into the file. The value ranges from 1 to 30 seconds depending on the bit stream.
- Redundancy: System supports redundancy backup function. It allows you backup recorded file in two disks. You can highlight Redundancy button to activate this function. Please note, before enable this function, please set at least one HDD as redundant. (Main menu->Advanced->HDD Management) Please refer to chapter 4.5.1.2 for detailed information.
Please note this function is null if there is only one HDD. The 4/8-channel HD-SDI 1080P 1.5U series product and the 4/8-channel HD-SDI 2U series product do not support redundancy function.
- Snapshot: You can enable this function to snapshot image when alarm occurs.
- Record types: There are four types: regular, motion detection (MD), Alarm, MD & alarm.
- Holiday setting: Click it you can see an interface shown as in Figure 4-15. Here you can set holiday date. Check the box, it means current channel shall record as your holiday setup. Please go to the Period interface to set the holiday date record setup.

Please highlight icon  to select the corresponding function. After completing all the setups please click save button, system goes back to the previous menu.

At the bottom of the menu, there are color bars for your reference. Green color stands for regular recording, yellow color stands for motion detection and red color stands for alarm recording. The white means the MD and alarm record is valid. Once you have set to record when the MD and alarm occurs, system will not record neither motion detect occurs nor the alarm occurs.

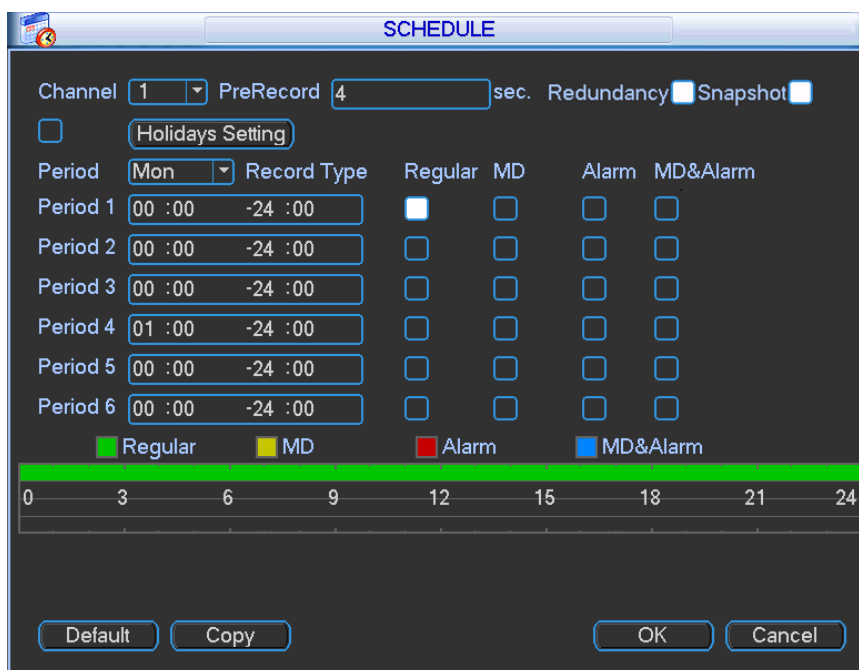

Figure 4-14

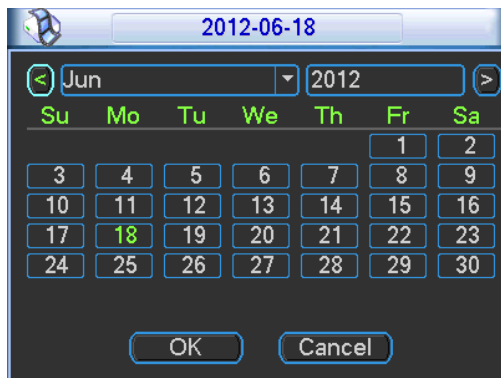

Figure 4-15

4.5.1.1 Quick Setup

Copy function allows you to copy one channel setup to another. After setting in channel 1, click Copy button, you can go to interface Figure 4-16. You can see current channel name is grey such as channel 1. Now you can select the channel you want to paste such as channel 5/6/7. If you want to save current setup of channel 1 to all channels, you can click the first box "ALL". Click the OK button to save current copy setup. Click the OK button in the Encode interface, the copy function succeeded.

Please note, if you select ALL in Figure 4-16, the record setup of all channels are the same and the Copy button becomes hidden.

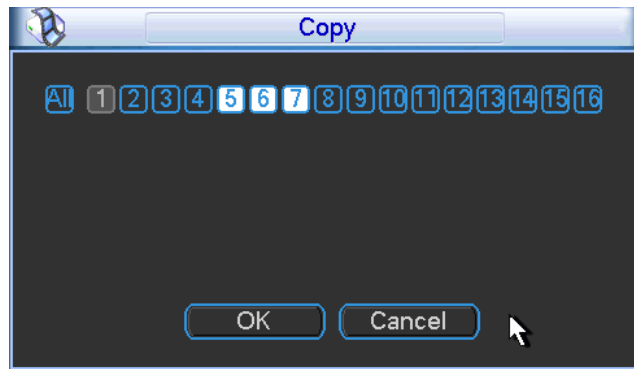

Figure 4-16

4.5.1.2 Redundancy

Redundancy function allows you to memorize record file in several disks. When there is file damage occurred in one disk, there is a spare one in the other disk. You can use this function to maintain data reliability and safety.

In the main menu, from Setting to Schedule, you can highlight redundancy button to enable this function. See Figure 4-14.

In the main menu, from Advanced to HDD management, you can set one or more disk(s) as redundant. You can select from the dropdown list. See Figure 4-17. System auto overwrites old files once hard disk is full.

Please note only read/write disk or read-only disk can backup file and support file search function, so you need to set at least one read-write disk otherwise you can not record video.

Note

About redundancy setup:

- If current channel is not recording, current setup gets activated when the channel begin recording the next time.
- If current channel is recording now, current setup will get activated right away, the current file will be packet and form a file, then system begins recording as you have just set.

After all the setups please click save button, system goes back to the previous menu.

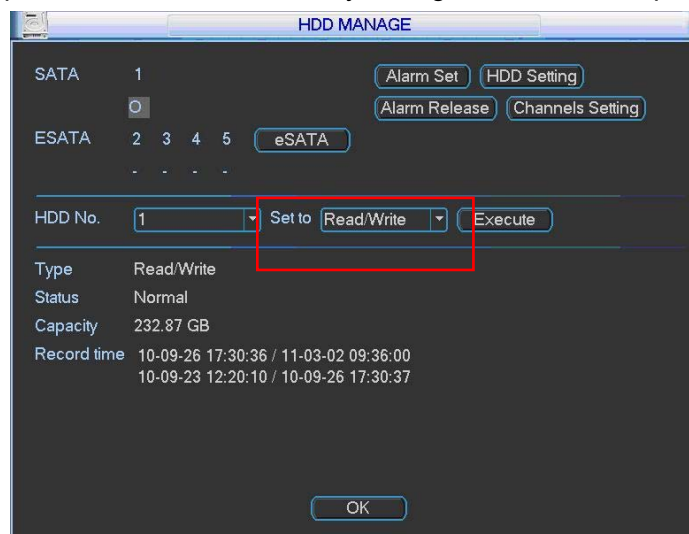

Figure 4-17

Playback or search in the redundant disk.

There are two ways for you to playback or search in the redundant disk.

- Set redundant disk(s) as read-only disk or read-write disk (Main menu->Advanced->HDD management). See Figure 4-17. System needs to reboot to get setup activated. Now you can search or playback file in redundant disk.
- Dismantle the disk and play it in another PC.

4.5.2 Snapshot

4.5.2.1 Schedule Snapshot

In Encode interface, click snapshot button to input snapshot mode, size, quality and frequency. See the interface on the left of Figure 4-18.

Note:

The HD-SDI 1080P 1.5U series product and the HD-SDI 2U series product support 1080P, 720P, D1, HD1, 2CIF, CIF, QCIF resolution.

The 960H supports 960H, D1, HD1, 2CIF, CIF, QCIF resolution.

In FTP (Main Menu->Network->Network Setting) interface, please input upload interval. See the interface in the middle of Figure 4-18.

In Schedule interface, please enable snapshot function. See interface on the right of Figure 4-18.

Please refer to the following figure for detailed information. See Figure 4-18.

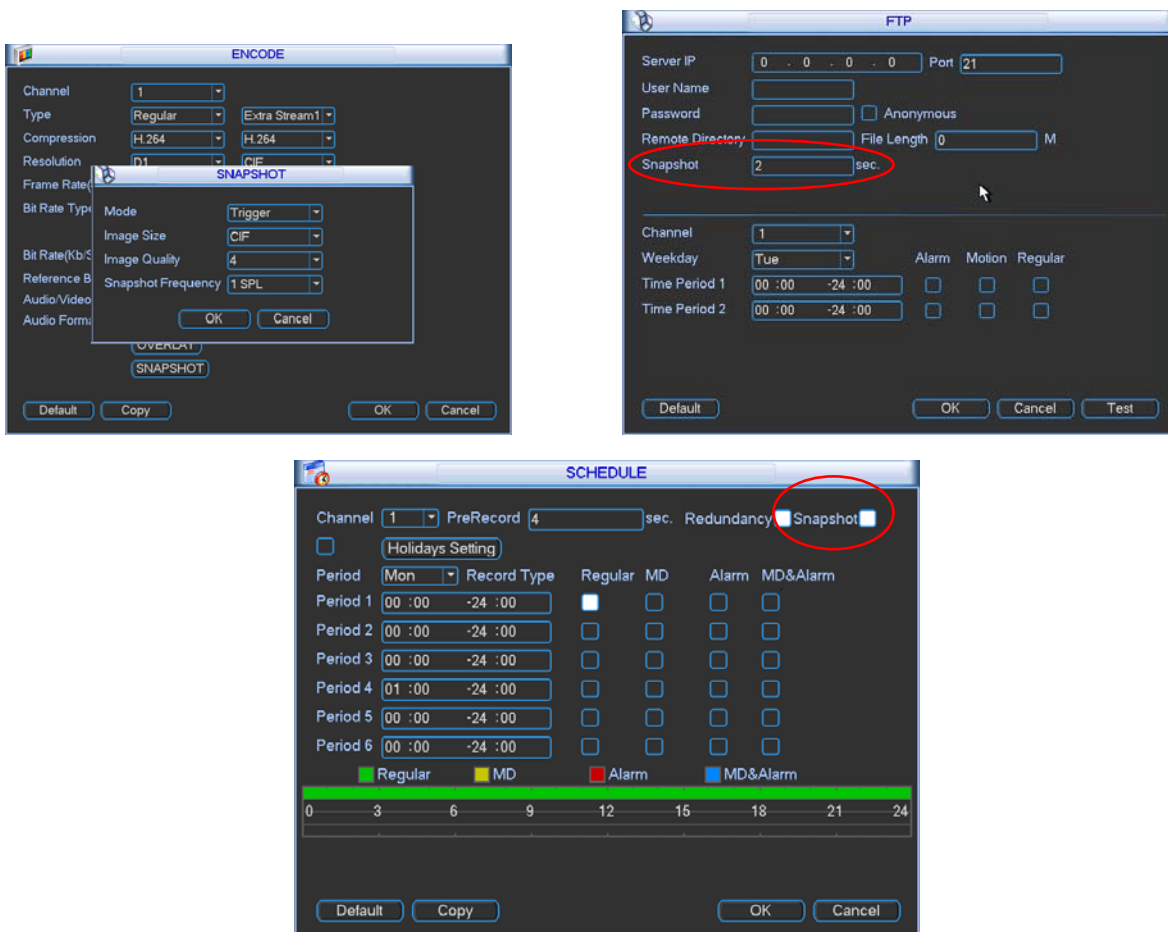

Figure 4-18

4.5.2.2 Activation Snapshot

Please follow the steps listed below to enable the activation snapshot function. After you enabled this function, system can snapshot when the corresponding alarm occurred.

- In Encode interface, click snapshot button to input snapshot mode, size, quality and frequency. See the interface on the left of Figure 4-19.
- In FTP interface please input upload interval. See the interface in the middle of Figure 4-18.
- In Detect interface please enable snapshot function for specified channels (interface in the middle of Figure 4-19). Or in alarm interface (interface on the right of Figure 4-19) please enable snapshot function for specified channels.

Please refer to the following figure for detailed information. See Figure 4-19.

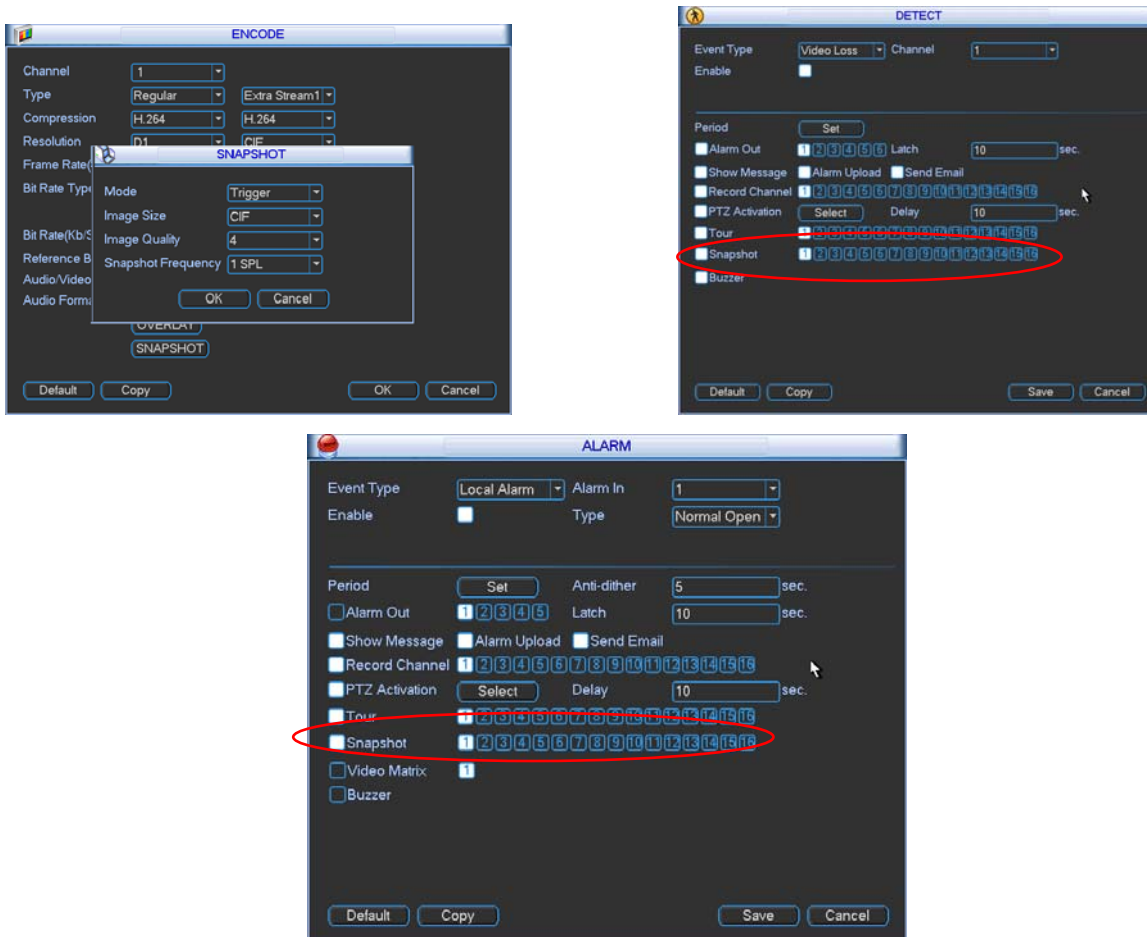

Figure 4-19

4.5.2.3 Priority

Please note the activation snapshot has the higher priority than schedule snapshot. If you have enabled these two types at the same time, system can activate the activation snapshot when alarm occurs, and otherwise system just operates the schedule snapshot.

4.5.3 Image FTP

In Network interface, you can set FTP server information. Please enable FTP function and then click save button. See Figure 4-20.

Please boot up corresponding FTP server.

Please enable schedule snapshot (Chapter 4.5.2.1) or activation snapshot (Chapter 4.5.2.2) first, now system can upload the image file to the FTP server.

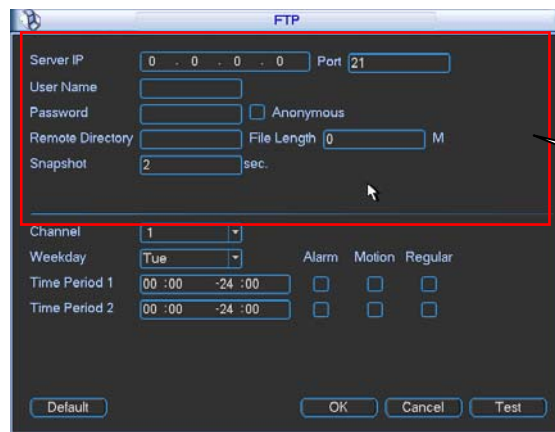

Please input the corresponding information here, if you just upload the image FTP.

Figure 4-20

4.6 Detect

4.6.1 Go to Detect Menu

In the main menu, from Setting to Detect, you can see motion detect interface. See Figure 4-21. There is three detection types: motion detection, video loss, camera masking.

4.6.2 Motion Detect

Detection menu is shown as below. See Figure 4-21

- Event type: from the dropdown list you can select motion detection type.
- Channel: select the channel to activate recording function once alarm occurred. Please make sure you have set MD record in encode interface(Main Menu->Setting->Schedule) and schedule record in manual record interface(Main Menu->Advanced->Manual Record)
- Latch: when motion detection complete, system auto delays detecting for a specified time. The value ranges from 10-300(Unit: second)
- Region: Click select button, the interface is shown as in Figure 4-22. Here you can set motion detection zone. There are 396(PAL)/330(NTSC) small zones. The green zone is current cursor position. Grey zone is the motion detection zone. Black zone is the disarmed zone. You can click Fn button to switch between the arm mode and disarm mode. In arm mode, you can click the direction buttons to move the green rectangle to set the motion detection zone. After you completed the setup, please click ENTER button to exit current setup. Do remember click save button to save current setup. If you click ESC button to exit the region setup interface system will not save your zone setup.
- Sensitivity: System supports 6 levels. The sixth level has the highest sensitivity.
- Show message: System can pop up a message to alarm you in the local host screen if you enabled this function.
- Alarm upload: System can upload the alarm signal to the network (including alarm centre) if you enabled current function.
- Send email: System can send out email to alert you when alarm occurs.
- PTZ activation: Here you can set PTZ movement when alarm occurs. Such as go to preset, tour & pattern when there is an alarm. Click “select” button, you can see an interface is shown as in Figure 4-23.

- Period: Click set button, you can see an interface is shown as in Figure 4-24. Here you can set for business day and non-business day. In Figure 4-24 click set button, you can see an interface is shown as in Figure 4-25. Here you can set your own setup for business day and non-business day.
- Anti-dither: Here you can set anti-dither time.
- Alarm output: when alarm occurred, system enables peripheral alarm devices.
- Tour: Here you can enable tour function when alarm occurs. System one-window tour. Please go to chapter 5.3.9 Display for tour interval setup.
- Snapshot: You can enable this function to snapshot image when alarm occurs.

Please highlight icon  to select the corresponding function. After all the setups please click save button, system goes back to the previous menu.

Note:

In motion detection mode, you can not use copy/paste to set channel setup since the video in each channel may not be the same.

In Figure 4-22, you can left click mouse and then drag it to set a region for motion detection.

Click Fn to switch between arm/withdraw motion detection. After setting, click enter button to exit.

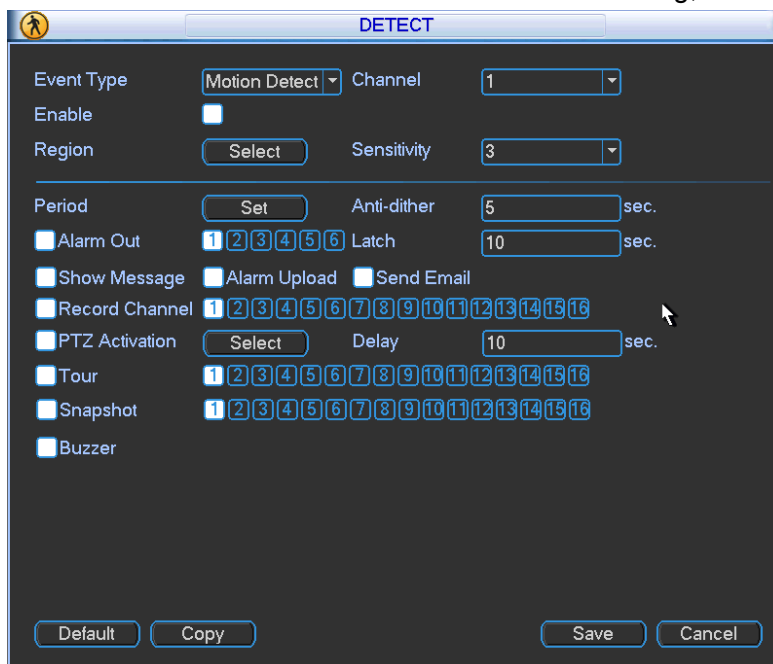

Figure 4-21

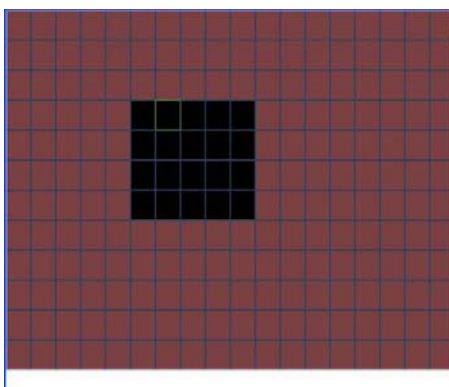

Figure 4-22



Figure 4-23

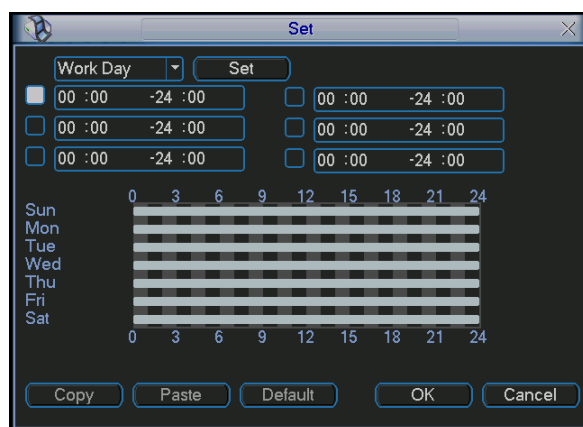

Figure 4-24

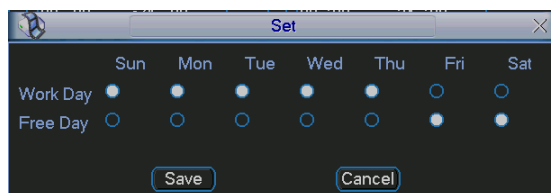

Figure 4-25

4.6.3 Video Loss

In Figure 4-21, select video loss from the type list. You can see the interface is shown as in Figure 4-26. This function allows you to be informed when video loss phenomenon occurred. You can enable alarm output channel and then enable show message function.

Tips:

You can enable preset activation operation when video loss occurs. Please refer to chapter 4.6.2 motion detection for detailed information.

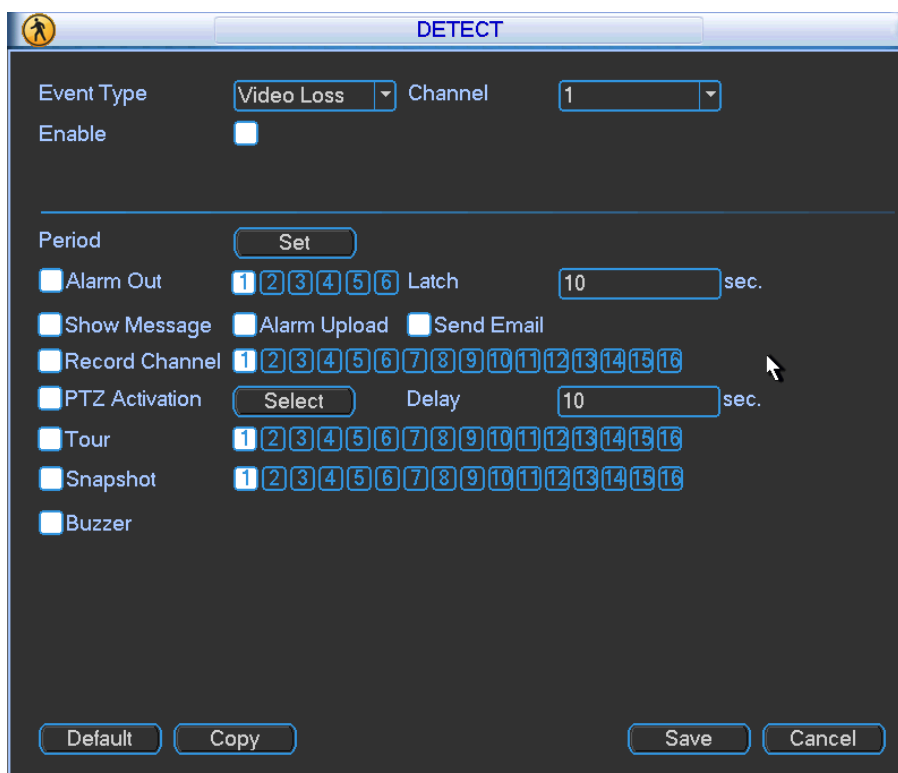

Figure 4-26

4.6.4 Camera Masking

When someone viciously masks the lens, or the output video is in one-color due to the environments light change, the system can alert you to guarantee video continuity. Camera masking interface is shown as in Figure 4-27.

Tips:

You can enable preset/tour/pattern activation operation when video loss occurs. Please refer to chapter 4.6.2 motion detection for detailed information.

Note:

In Detect interface, copy/paste function is only valid for the same type, which means you can not copy a channel setup in video loss mode to camera masking mode.

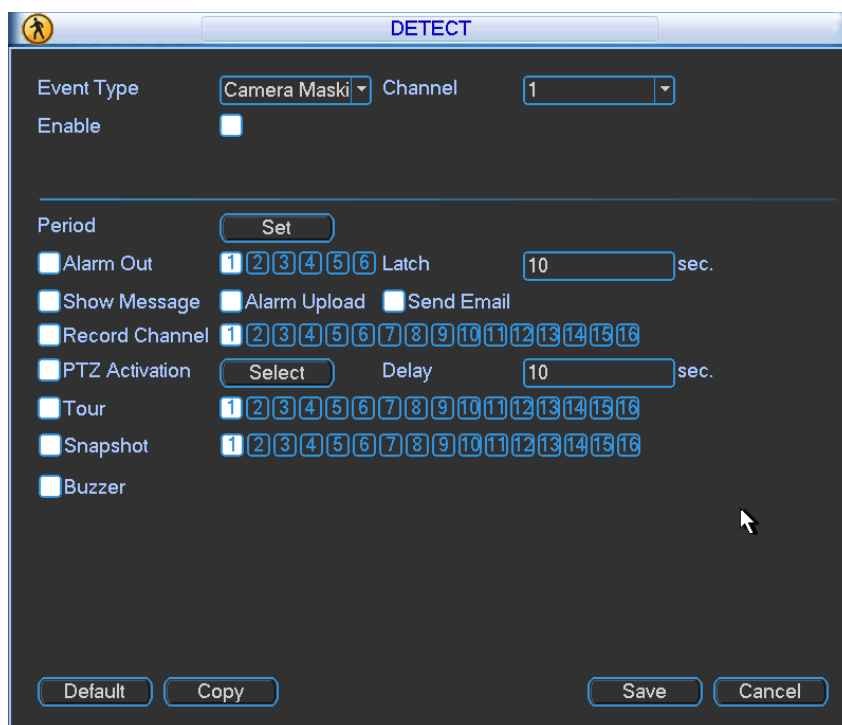

Figure 4-27

4.7 Alarm Setup and Alarm Activation

Before operation, please make sure you have properly connected alarm devices such as buzzer.

4.7.1 Go to alarm setup interface

In the main menu, from Setting to Alarm, you can see alarm setup interface. See Figure 4-28.

4.7.2 Alarm setup

Alarm interface is shown as below. See Figure 4-28.

- Alarm in: Here is for you to select channel number.
- Event type: There are two types. One is local input and the other is network input.
- Type: normal open or normal close.
- PTZ activation: When an alarm occurred, system can activate the PTZ operation. The PTZ activation lasts an anti-dither period.
 - ✧ In the Pan/Tilt/Zoom interface (Main menu->Setting-> Pan/Tilt/Zoom), please set video channel, speed dome protocol and etc.
 - ✧ Select the channel of current speed dome as current monitor video and the right click mouse to select Pan/Tilt/Zoom item. Now you can set preset, tour pattern.
 - ✧ In Figure 4-28, click “select” button, you can see an interface is shown as in Figure 4-29. Here you can set the activation operation such as preset tour, pattern and enable.
- Period: Click set button, you can see an interface is shown as in Figure 4-30. Here you can set for business day and non-business day. In Figure 4-30, click set button, you can see an interface is shown as in Figure 4-31. Here you can set your own setup for business day and non-business day.
- Anti-dither: Here you can set anti-dither time. The value ranges from 5 to 600s. The anti-dither time refers to the alarm signal lasts time. It can be seem as the alarm signal activation stays such as the buzzer, tour, PTZ activation, snapshot, channel record. The stay time

here does not include the latch time. During the alarm process, the alarm signal can begin an anti-dither time if system detects the local alarm again. The screen prompt, alarm upload, email and etc will not be activated. For example, if you set the anti-dither time as 10 second, you can see the each activation may last 10s if the local alarm is activated. During the process, if system detects another local alarm signal at the fifth second, the buzzer, tour, PTZ activation, snapshot, record channel will begin another 10s while the screen prompt, alarm upload, email will not be activated again. After 10s, if system detects another alarm signal, it can generate an alarm since the anti-dither time is out.

- Show message: System can pop up a message to alarm you in the local host screen if you enabled this function.
- Alarm upload: System can upload the alarm signal to the network (including alarm centre) if you enabled current function.
- Send email: System can send out email to alert you when alarm occurs.
- Record channel: you can select proper channel to record alarm video (Multiple choices).
 - ✧ You need to set alarm record mode as Schedule in Record interface (Main Menu->Advanced->Record). Please note the manual record has the highest priority. System record all the time no matter there is an alarm or not if you select Manual mode.
 - ✧ Now you can go to the Schedule interface (Main Menu->Setting->Schedule) to set the record type, corresponding channel number, week and date. You can select the record type:Regular/MD/Alarm/MD&Alarm. Please note, you can not select the MD&Alarm and MD(or Alarm) at the same time.
 - ✧ Now you can go to the Encode interface to select the alarm record and set the encode parameter (Main Menu->Setting->Encode).
 - ✧ Finally, you can set the alarm input as the local alarm and then select the record channel. The select channel begins alarm record when an alarm occurred. Please note system begins the alarm record instead of the MD record if the local alarm and MD event occurred at the same time.
- Latch: When the anti-dither time ended, the channel alarm you select in the alarm output may last the specified period. The value ranges from 1 to 300 seconds. This function is not for other alarm activation operations. The latch is still valid even you disable the alarm event function directly. .
- Tour: Here you can enable tour function when alarm occurs. System supports one-window tour. Please go to chapter 5.3.9 Display for tour interval setup.
- Snapshot: You can enable this function to snapshot image when alarm occurs.
- Video matrix: Check the box to enable this function. The video matrix output can display the alarm video of current channel when there is an alarm signal.
- Buzzer: Highlight the icon to enable this function. The buzzer beeps when alarm occurs.
- Snapshot: For snapshot operation, please refer to chapter 4.5.2.

Note: The network alarm means the alarm signal from the TCP/IP. You can enable the network alarm function via the net SDK. The network alarm does not have the device type; anti-dither and alarm upload function. The rest items are the same.

Please highlight icon  to select the corresponding function. After setting all the setups please click save button, system goes back to the previous menu.

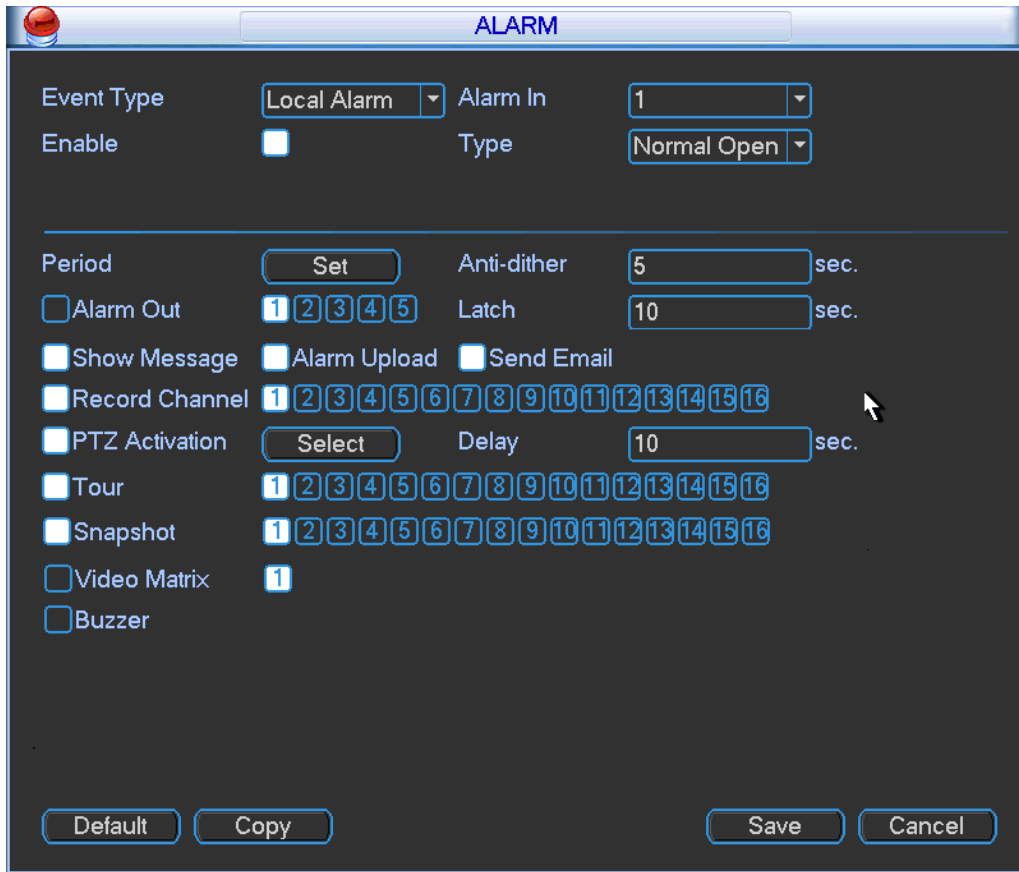

Figure 4-28

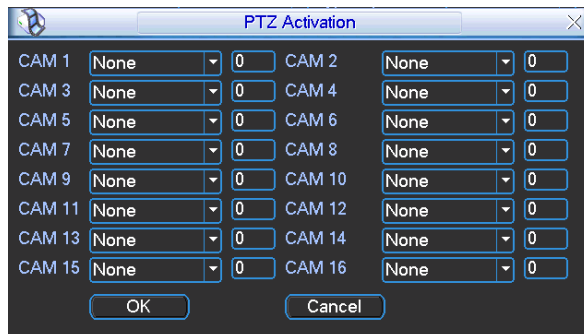

Figure 4-29

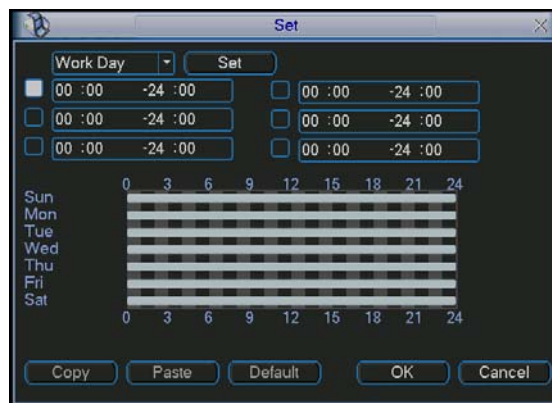

Figure 4-30

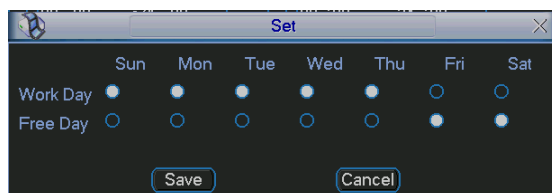

Figure 4-31

4.8 Backup

DVR support USB device backup and network download. Here we introduce USB backup. You can refer to Chapter 7 Web Client Operation for network download backup operation.

4.7.1 Detect Device

Click backup button, you can see an interface is shown as in Figure 4-32. Here is for you to view devices information.

You can view backup device name and its total space and free space. The device includes USB burner, flash disk, SD card, and portable HDD.

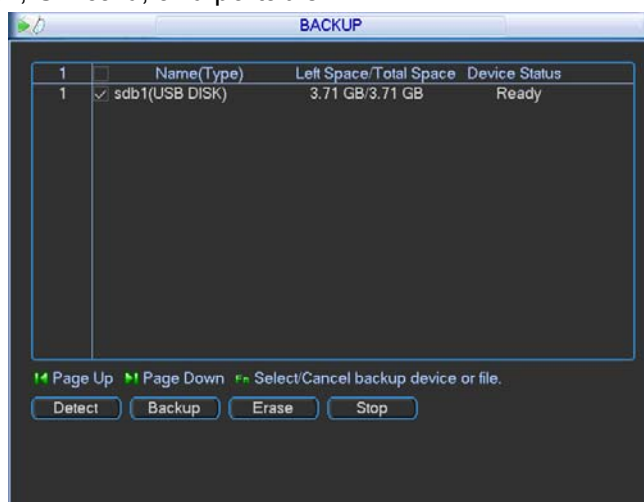

Figure 4-32

4.8.1 Backup

Select backup device and then set channel, file start time and end time.

Click add button, system begins search. All matched files are listed below. System automatically calculates the capacity needed and remained. See Figure 4-33.

system only backup files with a ✓ before channel name. You can use Fn or cancel button to delete ✓ after file serial number.

Click backup button, you can backup selected files. There is a process bar for you reference. When the system completes backup, you can see a dialogue box prompting successful backup.

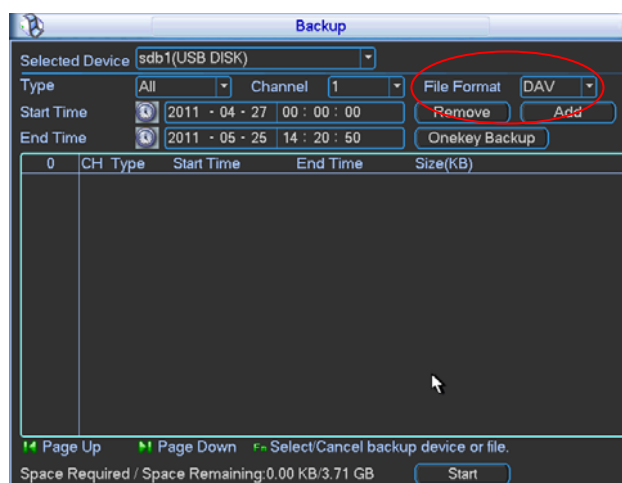

Figure 4-33

Click backup button, system begins burning. At the same time, the backup button becomes stop button. You can view the remaining time and process bar at the left bottom.

- File format: Click the file format; you can see there are two options: DAV/ASF.
- Picture backup: Please set the corresponding time, channel and then select the type as PIC from the dropdown list. See Figure 4-34. Please click the Add button and then select the pictures. Click the Start button; you can copy the specified pictures to the selected portable devices.

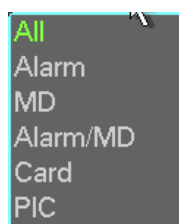

Figure 4-34

- One key backup: It includes three steps: the search, select all, start the backup. You can skip the above three steps and then copy all the searched files directly.

The file name format usually is: SN_CH+channel number+time Y+M+D+H+M+S. In the file name, the YDM format is the same as you set in general interface. (Main Menu ->Setting ->General).File extension name is .dav.

Tips:

During backup process, you can click ESC to exit current interface for other operation. The system will not terminate backup process.

Note:

When you click stop button during the burning process, the stop function becomes activated immediately. For example, if there are ten files, when you click stop system just backup five files, system only save the previous 5 files in the device (But you can view ten file names).

4.9 PTZ Control and Color Setup

Note: All the operations here are based on PELCOD protocol. For other protocols, there might be a little difference.

4.8.1 Cable Connection

Please follow the procedures below to go on cable connection

- Connect the dome RS485 port to DVR 485 port.
- Connect dome video output cable to DVR video input port.
- Connect power adapter to the dome.

4.8.2 PTZ Setup

Note: The camera video should be in the current screen. Before setup, please check the following connections are right:

- PTZ and decoder connection is right. Decoder address setup is right.
- Decoder A (B) line connects with DVR A (B) line.

Boot up the DVR, input user name and password.

In the main menu, click setting, and then click Pan/Tilt Control button. The interface is shown as in Figure 4-35. Here you can set the following items:

- Channel: select the current camera channel.
- Protocol: select corresponding PTZ protocol(such as PELCOD)
- Address: default address is 1.
- Baud rate: select corresponding baud rate. Default value is 9600.
- Data bits: select corresponding data bits. Default value is 8.
- Stop bits: select corresponding stop bits. Default value is 1.
- Parity: there are three options: odd/even/none. Default setup is none.



Figure 4-35

After completing all the setting please click save button.

In one window display mode, right click mouse (click “Fn” Button in the front panel or click “Fn” key in the remote control). The interface is shown as in Figure 4-36.



Figure 4-36

Click Pan/Tilt/Zoom, the interface is shown as below. See Figure 4-37.

Here you can set the following items:

- Step: value ranges from 1 to 8.
- Zoom
- Focus
- Iris



Please click icon  and  to adjust zoom, focus and iris.



Figure 4-37

In Figure 4-37, please click direction arrows (See Figure 4-38) to adjust PTZ position. There are total 8 direction arrows.



Figure 4-38

4.8.3 3D Intelligent Positioning Key

In the middle of the eight direction arrows, there is a 3D intelligent positioning key. See Figure 4-39. Please make sure your protocol supports this function and you need to use mouse to control.

Click this key, system goes back to the single screen mode. Drag the mouse in the screen to adjust section size. The dragged zone supports 4X to 16X speeds. It can realize PTZ automatically. The smaller zone you dragged, the higher the speed.



Figure 4-39

Here is a sheet for you reference.

Name	Function key	function	Shortcut key	Function key	function	Shortcut Key
Zoom		Near			Far	
Focus		Near			Far	
Iris		close			Open	

4.10 Preset/ Patrol/Pattern/Scan

In Figure 4-37, please click the “set” button. The interface is shown as below. See Figure 4-40. Here you can set the following items:

- Preset
- Tour
- Pattern
- Border

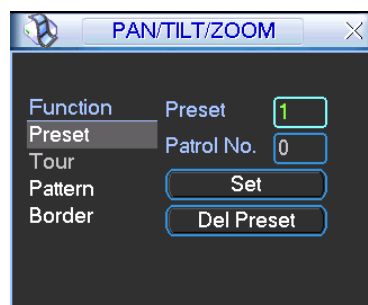

Figure 4-40

In Figure 4-37, click page switch button, the interface is shown as in Figure 4-41. Here you can activate the following functions:

- Preset
- Tour
- Pattern
- Auto scan
- Auto pan
- Flip
- Reset
- Page switch

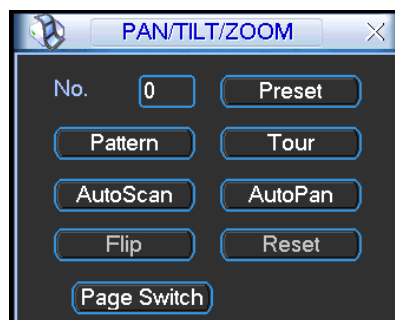

Figure 4-41

Note:

- Preset, tour and pattern all need the value to be the control parameter. You can define it as you require.
- You need to refer to your speed dome user's manual for Aux definition. In some cases, it can be used for special process.
- The following setups are usually operated in the Figure 4-37, Figure 4-40 and Figure 4-41.

4.9.1Preset Setup

In Figure 4-37, use eight direction arrows to adjust camera to the proper position.

In Figure 4-40, click preset button and input preset number. The interface is shown as in Figure 4-42.

Now you can add this preset to one tour.



Figure 4-42

4.9.2 Activate Preset

In Figure 4-41, please input preset number in the No. blank, and click preset button.

4.9.3 Patrol setup (Tour Setup)

In Figure 4-38, click patrol button. The interface is shown as in Figure 4-43. Input preset number and add this preset to a patrol (tour). For each patrol (tour), you can input max 80 presets.



Figure 4-43

4.9.4 Activate Patrol (tour)

In Figure 4-40, input patrol (tour) number in the No. blank and click patrol button

4.9.5 Pattern Setup

In Figure 4-40, click pattern button and then click “begin” button. The interface is shown as in Figure 4-44. Then you can go to Figure 4-37 X to modify zoom, focus, and iris.

Go back to Figure 4-44 and click “end” button. You can memorize all these operations as pattern 1.



Figure 4-44

4.9.6 Activate Pattern Function

In Figure 4-39, input mode value in the No. blank, and click pattern button.

4.9.7 Auto Scan Setup

In Figure 4-38, click border button. The interface is shown as in Figure 4-43.

Please go to Figure 4-35, use direction arrows to select camera left limit

Then please go to Figure 4-43 and click left limit button

Repeat the above procedures to set right limit.



Figure 4-45

4.9.8 Activate Auto Scan

In Figure 4-41, click “Auto Scan” button, the system begins auto scan. Correspondingly, the auto scan button becomes Stop button. Click stop button to terminate scan operation.

4.11 Flip

In Figure 4-41, click page switch button, you can see an interface is shown as below. See Figure 4-46. Here you can set auxiliary function. The aux value has relationship with the Aux button of the decoder.

Click page switch button again, system goes back to Figure 4-37.

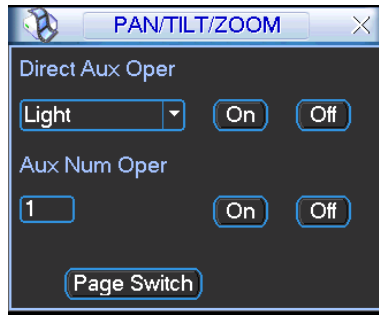
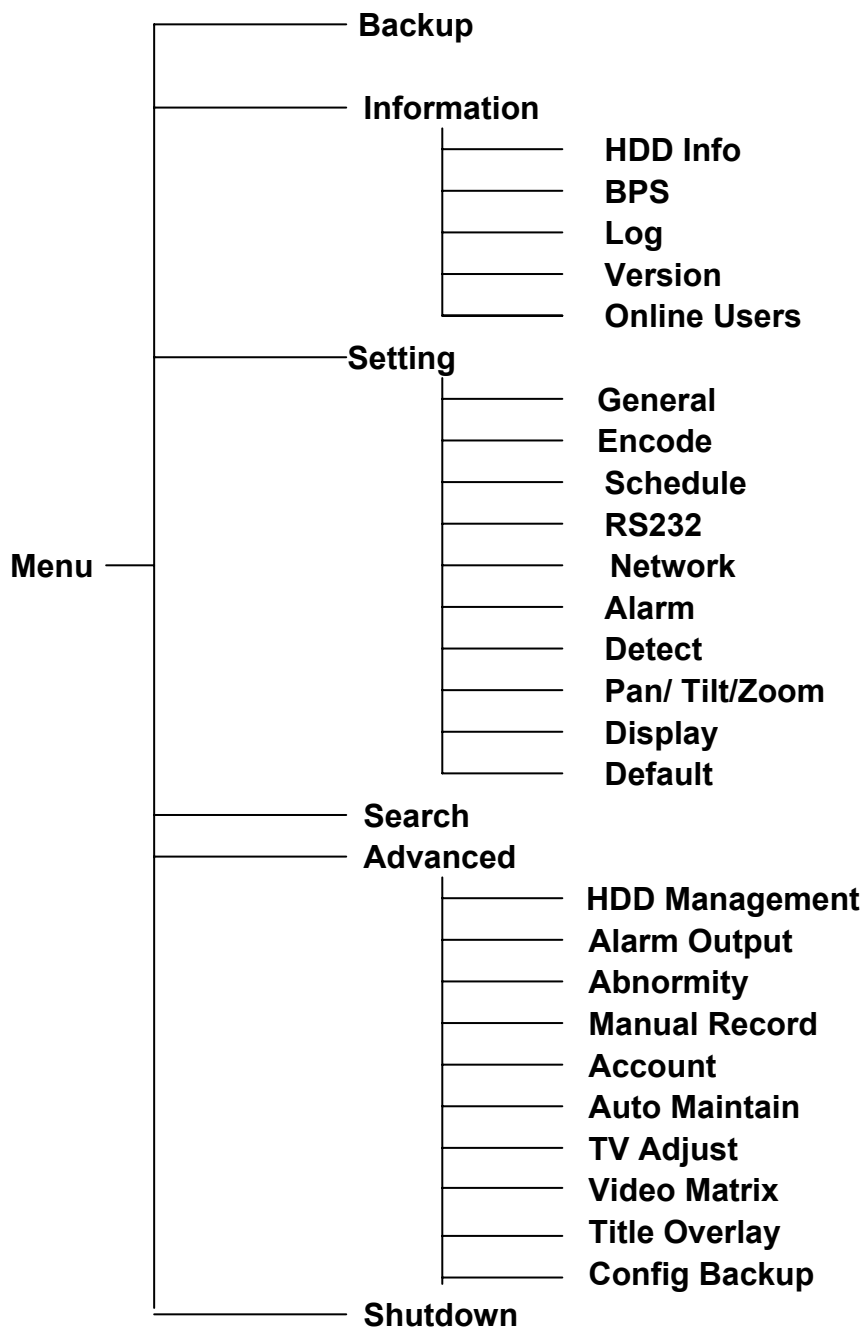

Figure 4-46

5 Understanding of Menu Operations and Controls

5.1 Menu Tree

This series DVR menu tree is shown as below.



5.2 Main Menu

After you logged in, the system main menu is shown as below. See Figure 5-1. There are total six icons: search, Information, setting, backup, advanced and shutdown. Move the cursor to highlight the icon, then double click mouse to enter the sub-menu.

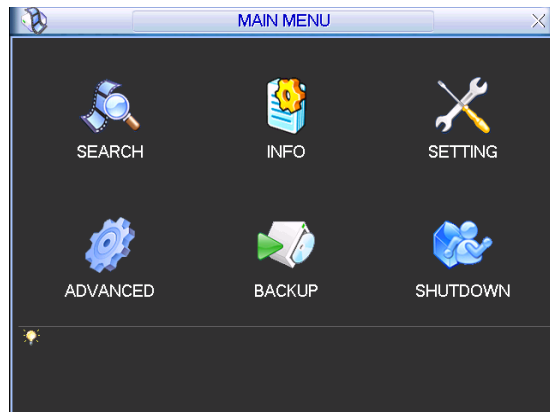

Figure 5-1

5.3 Setting

In main menu, highlight setting icon and double click mouse. System setting interface is shown as below. See Figure 5-2.

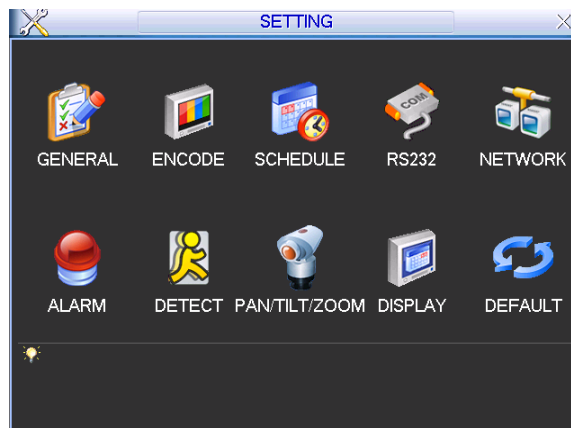

Figure 5-2

5.3.1 General

General setting includes the following items. See Figure 5-3.

- System time: Here is for you to set system time
- Date format: There are three types: YYYY-MM-DD: MM-DD-YYYYY or DD-MM-YYYY.
- Date separator: There are three denotations to separate date: dot, beeline and solidus.
- DST: Here you can set DST time and date. Please enable DST function and then click set button. You can see an interface is shown as in Figure 5-4. Here you can set start time and end time by setting corresponding week setup. In Figure 5-4, enable date button, you can see an interface is shown as in Figure 5-5. Here you can set start time and end time by setting corresponding date setup.
- Time format: There are two types: 24-hour mode or 12-hour mode.
- Language: System supports various languages: Chinese (simplified), Chinese (Traditional), English, Italian, Japanese, French, Spanish (All languages listed here are optional. Slight difference maybe found in various series.)
- HDD full: Here is for you to select working mode when hard disk is full. There are two options: stop recording or rewrite. If current working HDD is overwritten or the current HDD is full

while the next HDD is no empty, then system stops recording, If the current HDD is full and then next HDD is not empty, then system overwrites the previous files.

- Pack duration: Here is for you to specify record duration. The value ranges from 1 to 120 minutes. Default value is 60 minutes.
- Video standard: There are two formats: NTSC and PAL.
- Auto logout: Here is for you to set auto logout interval once login user remains inactive for a specified time. Value ranges from 0 to 60 minutes.
- Startup wizard: Once you check the box here, system will go to the startup wizard directly when the system restarts the next time. Otherwise, it will go to the login interface.
- Device ID: Please input a corresponding device name here.
- Real-time playback: It is to set playback time you can view in the preview interface (chapter 4.2 Live Viewing). The value ranges from 5 to 60 minutes.
- Startup wizard: Check the box here, system goes to the startup wizard when the device boots up the next time. Otherwise, it goes to the system login interface directly.
- Navigation bar: Check the box here, system displays the navigation bar on the interface.

Note:

Since system time is very important, do not modify time casually unless there is a must!

Before your time modification, please stop record operation first!

After completing all the setups please click save button, system goes back to the previous menu.

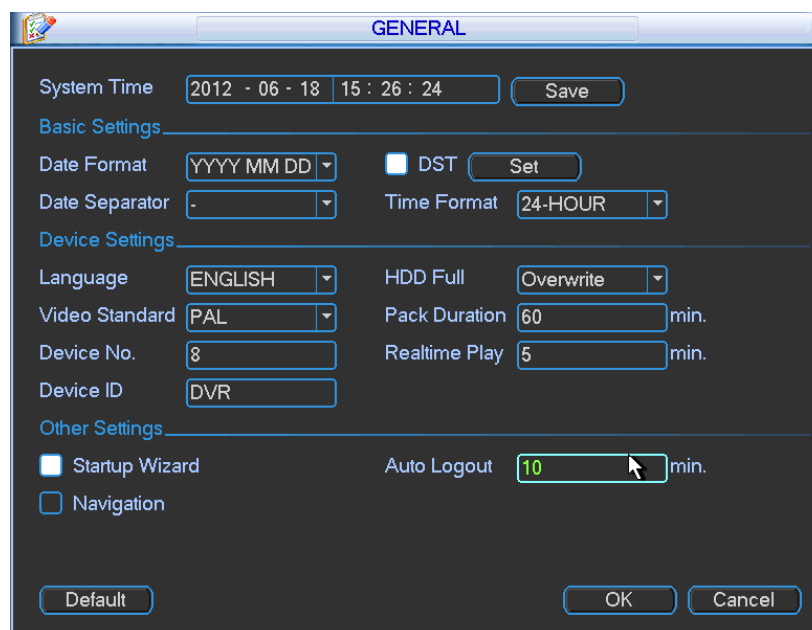

Figure 5-3

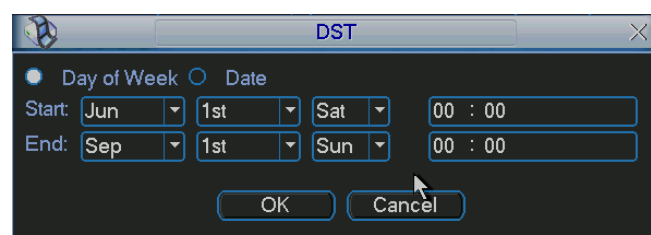

Figure 5-4

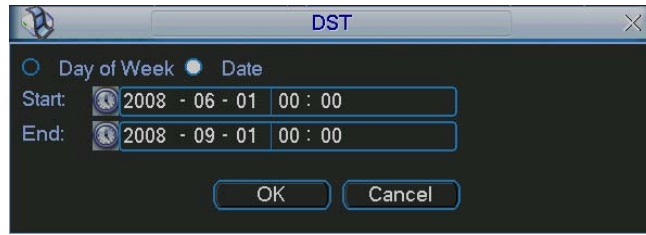

Figure 5-5

5.3.2 Encode

Encode setting includes the following items. See Figure 5-6.

Please note some series do not support extra stream.

- Channel: Select the channel you want.
- Type: Please select from the dropdown list. There are three options: regular/motion detect/alarm. You can set the various encode parameters for different record types.
- Compression: System supports H.264.
- Resolution: System supports various resolutions, you can select from the dropdown list. The main stream supports D1/HD1/2CIF/CIF/QCIF and the extra stream supports CIF/QCIF. Please note the option may vary due to different series.

Note:

a). For HD-SDI series, the main code-stream types are 1080P/720P/D1/HD1/2CIF/CIF/QCIF; Extra stream resolution supports D1/CIF/QCIF.

b). For 960H series, the main code-stream types are 960H/D1/HD1/2CIF/CIF/QCIF; Extra stream resolution supports 960H/D1/HD1/2CIF/CIF/QCIF.

- Frame rate: It ranges from 1f/s to 25f/s in NTSC mode and 1f/s to 30f/s in PAL mode.

Note:

For the 16-channel series product of the HD-SDI 1080P 1.5U series product and the HD-SDI 1080P 2U series product, when the main stream resolution is 1080P, the frame rate of the 1/5/9/13-channel max supports 25f/s or 30f/s and the frame rate of the rest channels support 12f/s or 15f/s. The extras stream of the HD-SDI 1080P 1.5U series product and the HD-SDI 1080P 2U series product support D1 (6fps or 7f/s.)

- Bit rate type: System supports two types: CBR and VBR. In VBR mode, you can set video quality.
- Quality: There are six levels ranging from 1 to 6. The sixth level has the highest image quality.
- Video/audio: You can enable or disable the video/audio.
- Overlay: Click overlay button, you can see an interface is shown in Figure 5-7.
- ✧ Cover area (Privacy mask): Here is for you to set privacy mask section. You can drag you mouse to set proper section size. In one channel video, system max supports 4 zones in one channel.
- ✧ Preview/monitor: privacy mask has two types. Preview and Monitor. Preview means the privacy mask zone can not be viewed by user when system is in preview status. Monitor means the privacy mask zone can not be view by the user when system is in monitor status.
- ✧ Time display: You can select system displays time or not when you playback. Please click set button and then drag the title to the corresponding position in the screen.

- ✧ Channel display: You can select system displays channel number or not when you playback. Please click set button and then drag the title to the corresponding position in the screen.
- ✧ Copy: After you complete the setup, you can click Copy button to copy current setup to other channel(s). You can see an interface is shown as in Figure 5-8. You can see current channel number is grey. Please check the number to select the channel or you can check the box ALL. Please click the OK button in Figure 5-8 and Figure 5-6 respectively to complete the setup. Please note, once you check the All box, you set same encode setup for all channels. Audio/video enable box, overlay button and the copy button is shield. See Figure 5-9.

Please highlight icon  to select the corresponding function.

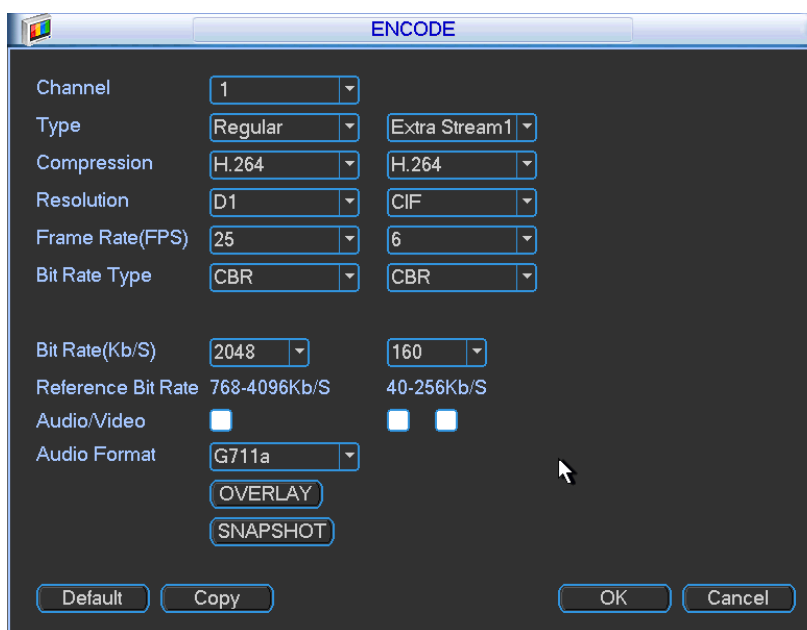

Figure 5-6

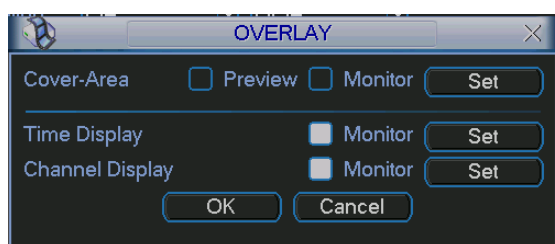

Figure 5-7

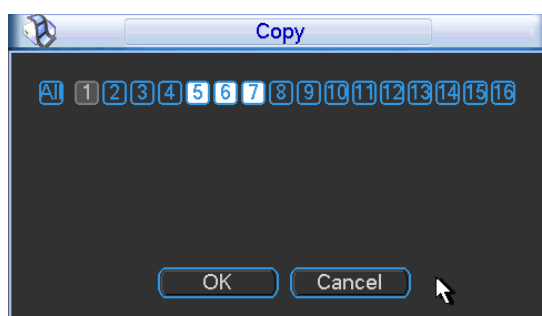

Figure 5-8

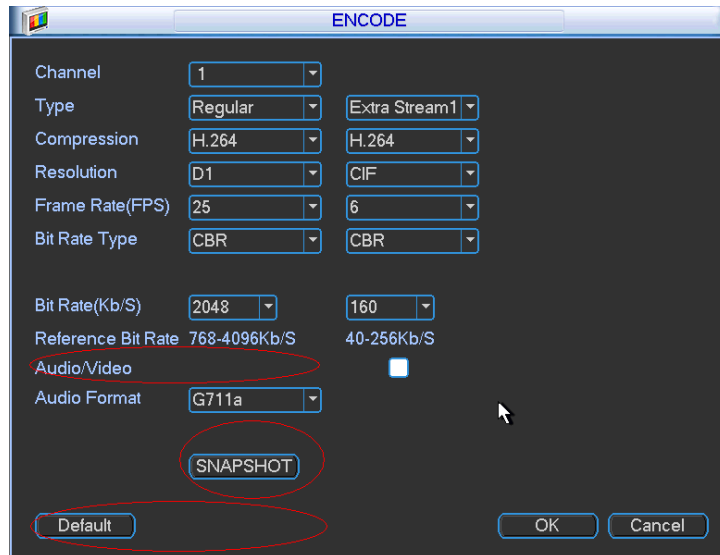

Figure 5-9

5.3.3 Schedule

Please refer to chapter 4.5 schedule.

5.3.4 RS232

RS232 interface is shown as below. There are five items. See Figure 5-10.

- Function: There are various devices for you to select. Console is for you to use the COM or mini-end software to upgrade or debug the program. The control keyboard is for you to control the device via the special keyboard. Transparent COM (adapter) is to connect to the PC to transfer data directly. Protocol COM is for card overlay function. Network keyboard is for you to use the special keyboard to control the device. PTZ matrix is to connect to the peripheral matrix control.
- Baud rate: You can select proper baud rate.
- Data bit: You can select proper data bit. The value ranges from 5 to 8.
- Stop bit: There are three values: 1/1.5/2.
- Parity: there are five choices: none/odd/even/space mark.

System default setup is:

- Function: Console
- Baud rate:115200
- Data bit:8
- Stop bit:1
- Parity: None

After completing all the setups please click save button, system goes back to the previous menu.

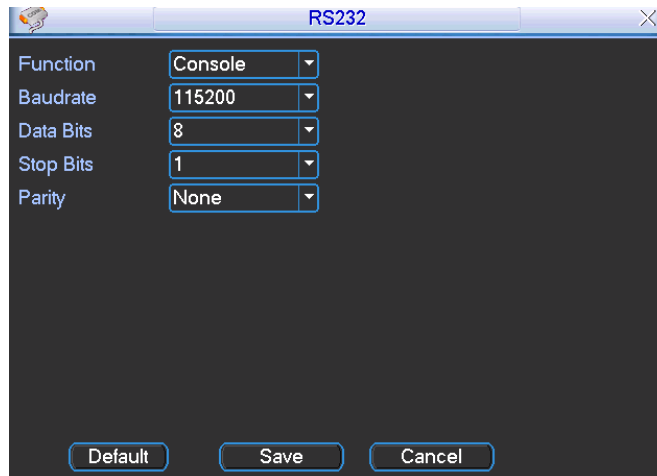

Figure 5-10

5.3.5 Network

Here is for you to input network information.

The single network adapter interface is shown as in Figure 5-11 and the dual network adapters interface is shown as in Figure 5-12.

- IP Version: There are two options: IPv4 and IPv6. Right now, system supports these two IP address format and you can access via them.
- MAC address: The host in the LAN can get a unique MAC address. It is for you to access in the LAN. It is read-only.
- IP address: Here you can use up/down button (▲▼) or input the corresponding number to input IP address. Then you can set the corresponding subnet mask the default gateway.
- Subnet prefix: The input value ranges from 0 to 128. It is to mark a specified network MAC address. Usually it includes an organization of multiple-level.
- Default gateway: Here you can input the default gateway. **Please note system needs to check the validity of all IPv6 addresses. The IP address and the default gateway shall be in the same IP section. That is to say, the specified length of the subnet prefix shall have the same string.**
- DHCP: It is to auto search IP. When enable DHCP function, you can not modify IP/Subnet mask /Gateway. These values are from DHCP function. If you have not enabled DHCP function, IP/Subnet mask/Gateway display as zero. You need to disable DHCP function to view current IP information. Besides, when PPPoE is operating, you can not modify IP/Subnet mask /Gateway.
- TCP port: Default value is 37777. You can change if necessary.
- UDP port: Default value is 37778. You can change if necessary.
- HTTP port: Default value is 80.
- RTSP port: Default value is 554.

Important: System needs to reboot after you changed and saved any setup of the above four ports. Please make sure the port values here do not conflict.

- Max connection: system support maximal 20 users. 0 means there is no connection limit.
- Preferred DNS server: DNS server IP address.
- Alternate DNS server: DNS server alternate address.
- Transfer mode: Here you can select the priority between fluency/video qualities.

- LAN download: System can process the downloaded data first if you enable this function. The download speed is 1.5X or 2.0X of the normal speed.
- Dual network adapters mode:
 - ✧ Multiple-address mode: eth0 and eth1 operate separately. You can use the services such as HTTP, RTP service via eth0 or the eth1 usually you need to set one default card(default setup is eth0) to request the auto network service form the device-end such as DHCP, email ,FTP and etc. In multiple-address mode, system network status is shown as offline once one card is offline.
 - ✧ Network fault-tolerance: In this mode, device uses bond0 to communicate with the external devices. You can focus on one host IP address. At the same time, you need to set one master card. Usually there is only one running card (master card).System can enable alternate card when the master card is malfunction. The system is shown as offline once these two cards are both offline. Please note these two cards shall be in the same LAN.
 - ✧ Load balance: In this mode, device uses bond0 to communicate with the external device. The eth0 and eth1 are both working now and bearing the network load. Their network load are general the same. The system is shown as offline once these two cards are both offline. Please note these two cards shall be in the same LAN.

Important

For the IP address of IPv6 version, default gateway, preferred DNS and alternate DNS, the input value shall be 128-digit. It shall not be left in blank.

After completing all the setups please click save button, system goes back to the previous menu.

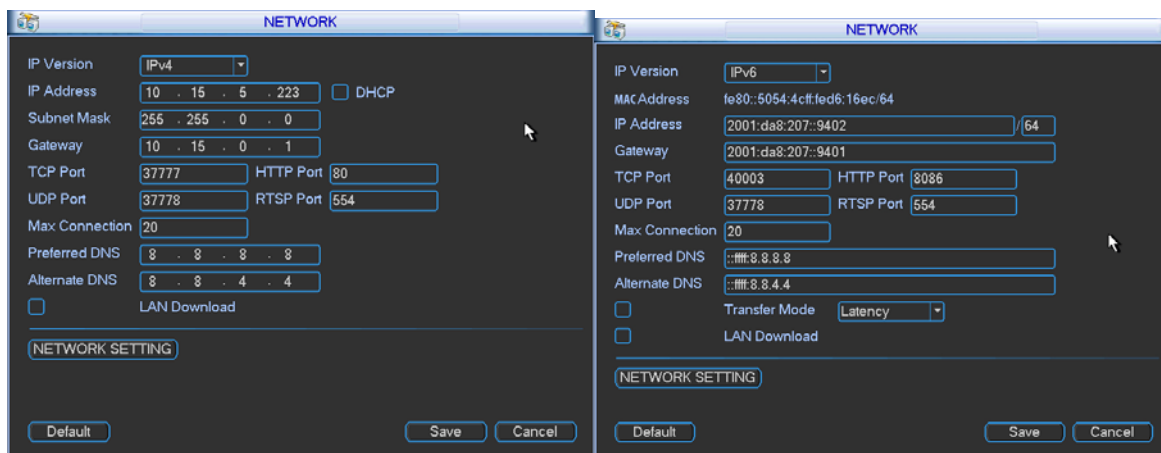

Figure 5-11

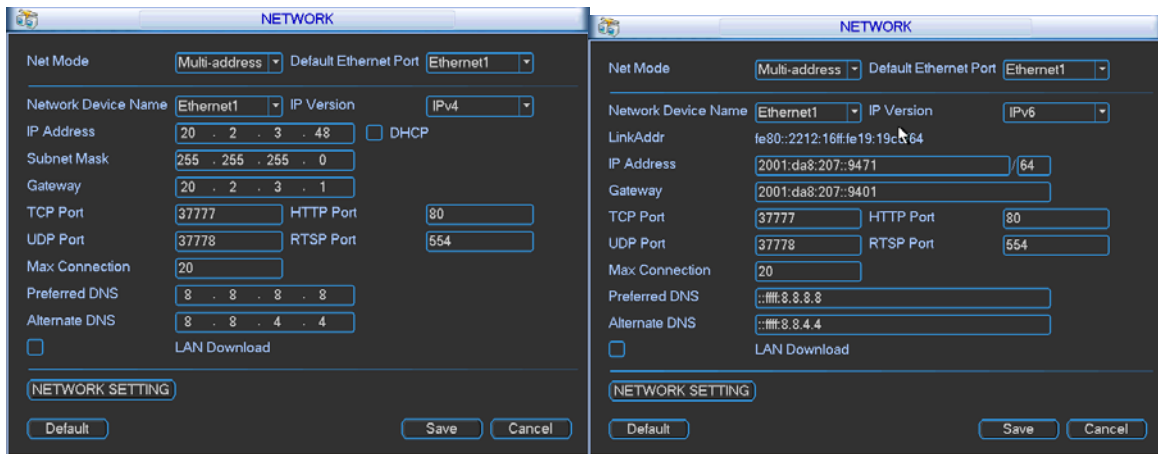

Figure 5-12

5.3.5.1 Network Setting

Network setting interface is shown as in Figure 5-13. Please check the box to enable corresponding function and then double click current item to go to setup interface.

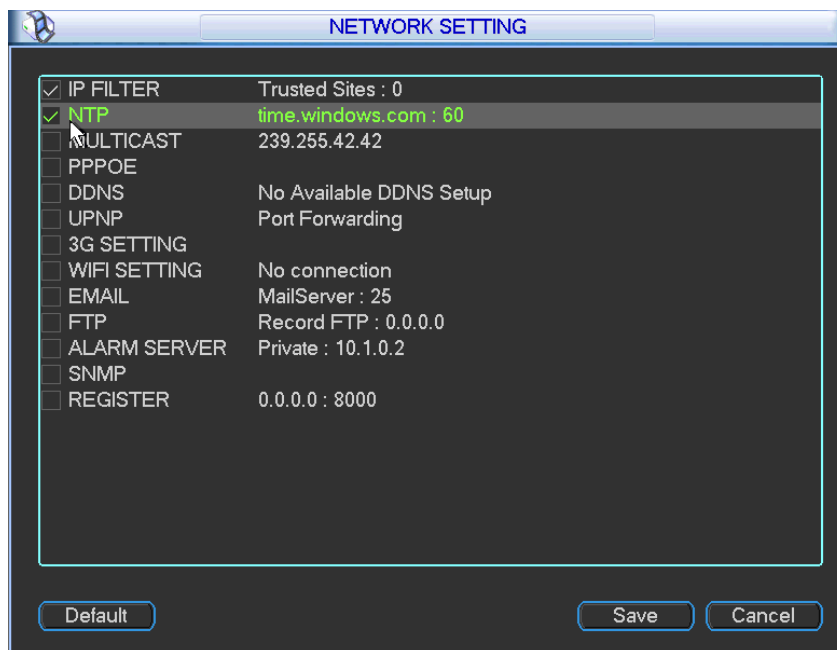

Figure 5-13

5.3.5.2 IP Filter

IP filter interface is shown as in Figure 5-14 (IPv4) and Figure 5-15 (IPv6). You can add IP in the following list. The list supports max 64 IP addresses.

Please note after you enabled this function, only the IP listed below can access current DVR.

If you disable this function, all IP addresses can access current DVR.

The system supports IPv4 and IPv6 address format.

Please note:

- If you input the IPv6 address format, system needs to check its validity and optimize its format. For example, it can optimize IP:"fe80::0054:0cff:fefa:1682" to "fe80::54:cff:fefa:1682".

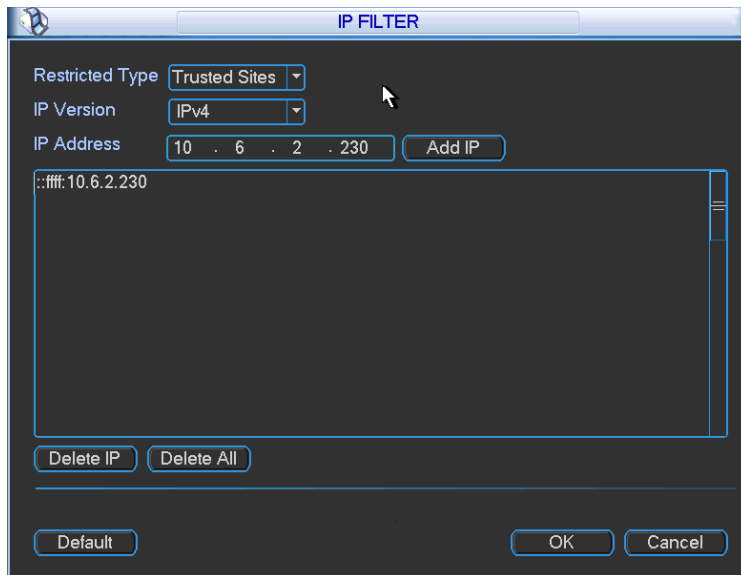

Figure 5-14

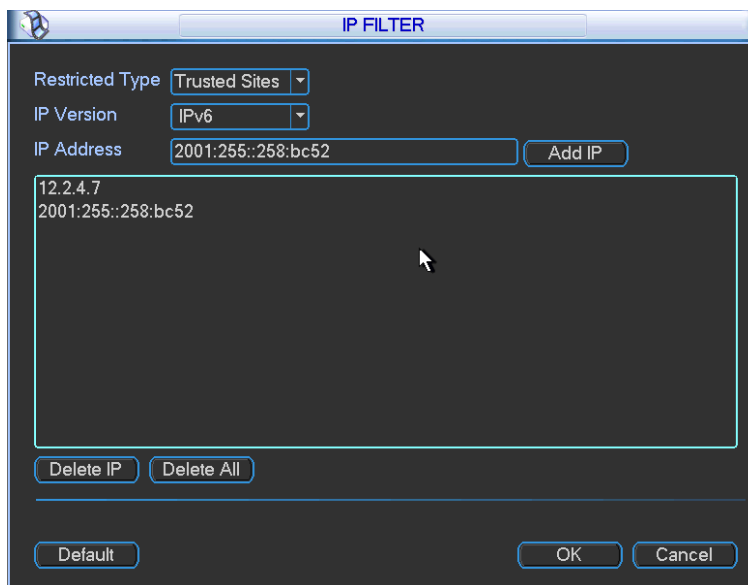

Figure 5-15

5.3.5.3 NTP Setup

You need to install SNTP server (Such as Absolute Time Server) in your PC first. In Windows XP OS, you can use command “net start w32time” to boot up NTP service.

NTP setup interface is shown as in Figure 5-16.

- Host IP: Input your PC address.
- Port: This series DVR supports TCP transmission only. Port default value is 123.
- Update interval: minimum value is 1. Max value is 65535. (Unit: minute)
- Time zone: select your corresponding time zone here.
- Manual update: It allows you to synchronize the time with the server manually.

Here is a sheet for your time zone setup.

City /Region Name	Time Zone
London	GMT+0
Berlin	GMT+1
Cairo	GMT+2

Moscow	GMT+3
New Deli	GMT+5
Bangkok	GMT+7
Beijing (Hong Kong)	GMT+8
Tokyo	GMT+9
Sydney	GMT+10
Hawaii	GMT-10
Alaska	GMT-9
Pacific Time(P.T)	GMT-8
American Mountain Time(M.T)	GMT-7
American Central Time(C.T)	GMT-6
American Eastern Time(E.T)	GMT-5
Atlantic Time	GMT-4
Brazil	GMT-3
Middle Atlantic Time	GMT-2

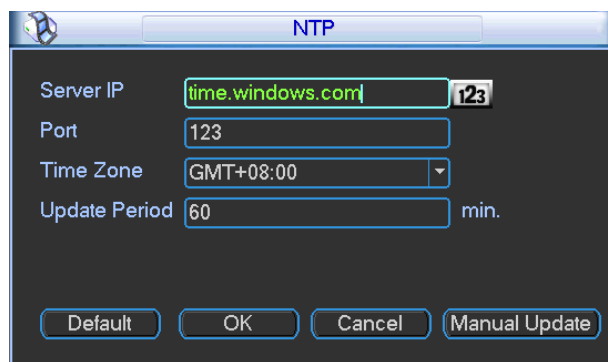

Figure 5-16

5.3.5.4 Multiple Cast Setup

Multiple-cast setup interface is shown as in Figure 5-17.



Figure 5-17

Here you can set a multiple cast group. Please refer to the following sheet for detailed information.

- IP multiple cast group address
-224.0.0.0-239.255.255.255
“D” address space
 - The higher four-bit of the first byte=“1110”
- Reserved local multiple cast group address
-224.0.0.0-224.0.0.255
-TTL=1 When sending out telegraph

-For example

224.0.0.1 All systems in the sub-net

224.0.0.2 All routers in the sub-net

224.0.0.4 DVMRP router

224.0.0.5 OSPF router

224.0.0.13 PIMv2 router

- Administrative scoped addressees

-239.0.0.0-239.255.255.255

-Private address space

- Like the single broadcast address of RFC1918
- Can not be used in Internet transmission
- Used for multiple cast broadcast in limited space.

Except the above mentioned addresses of special meaning, you can use other addresses. For example:

Multiple cast IP: 235.8.8.36

Multiple cast PORT: 3666.

After you logged in the Web, the Web can automatically get multiple cast address and add it to the multiple cast groups. You can enable real-time monitor function to view the view.

Please note multiple cast function applies to special series only.

5.3.5.5 PPPoE

PPPoE interface is shown as in Figure 5-18.

Input "PPPoE name" and "PPPoE password" you get from your ISP (Internet service provider). Click save button, you need to restart to activate your configuration.

After rebooting, DVR will connect to internet automatically. The IP in the PPPoE is the DVR dynamic value. You can access this IP to visit the unit.

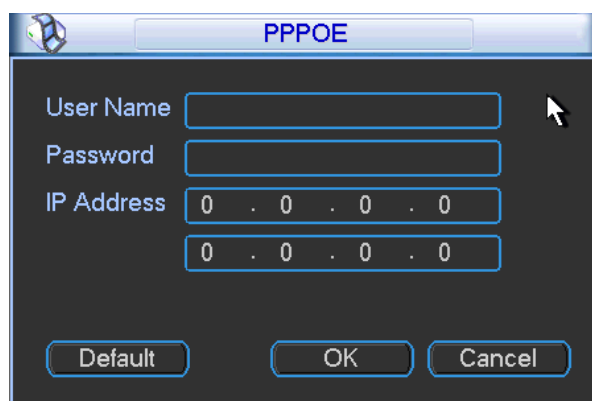

Figure 5-18

5.3.5.6 DDNS Setup

DDNS setup interface is shown as in Figure 5-19.

You need a PC of fixed IP in the internet and there is the DDNS software running in this PC. In other words, this PC is a DNS (domain name server).

In network DDNS, please select DDNS type and highlight enable item. Then please input your PPPoE name you get from you IPS and server IP (PC with DDNS). Click save button and then reboot system.

Click save button, system prompts for rebooting to get all setup activated.

After rebooting, open IE and input as below:

http: //(DDNS server IP)/(virtual directory name)/webtest.htm

e.g.: http: //10.6.2.85/DVR_DDNS/webtest.htm.)

Now you can open DDNSServer web search page.

DDNS

DDNS Type: Private DDNS Enable

Server IP: www.dahuaddns.com

Port: 80

Domain Mode: Default Domain Custom Domain Name

Domain Name: 52544CFAADAF.dahuaddns.com

User Name: Please input email address.

Note: System will reclaim the domain that is idle for more than one year. You can get a notification email one month before the reclaim if your email address setup is right.

Default Test OK Cancel

Figure 5-19

Please note NNDS type includes: CN99 DDNS, NO-IP DDNS, Private DDNS and Dyndns DDNS.

All the DDNS can be valid at the same time, you can select as you requirement.

Private DDNS function shall work with special DDNS server and special Professional Surveillance Software (PSS).

Private DDNS and Client-end Introduction

1) Background Introduction

Device IP is not fixed if you use ADSL to login the network. The DDNS function allows you to access the DVR via the registered domain name. Besides the general DDNS ,the private DDNS works with the device from the manufacturer so that it can add the extension function.

2) Function Introduction

The private DDNS client has the same function as other DDNS client end. It realizes the bonding of the domain name and the IP address. Right now, current DDNS server is for our own devices only. You need to refresh the bonding relationship of the domain and the IP regularly. There is no user name, password or the ID registration on the server. At the same time, each device has a default domain name (Generated by MAC address) for your option. You can also use customized valid domain name (has not registered.).

3) Operation

Before you use our private DDNS, you need to enable this service and set proper server address, port value and domain name.

- Server address: www.dahuaddns.com
- Port number: 80
- Domain name: There are two modes: Default domain name and customized domain name.

Except default domain name registration, you can also use customized domain name (You can input your self-defined domain name.) After successful registration, you can use domain name to login installed of the device IP.

- User name: It is optional. You can input your commonly used email address.

Important

- Do not register frequently. The interval between two registrations shall be more than 60 seconds. Too many registration requests may result in server attack.
- System may take back the domain name that is idle for one year. You can get a notification email before the cancel operation if your email address setup is OK.

5.3.5.7 UPNP

The UPNP protocol is to establish a mapping relationship between the LAN and the WAN. Please input the router IP address in the LAN in Figure 5-12. Double click the UPNP item in Figure 5-13, you can see the following interface. See Figure 5-20.

- UPNP on/off : Turn on or off the UPNP function of the device.
- Status: When the UPNP is offline, it shows as “Unknown”. When the UPNP works it shows “Success”
- Router LAN IP: It is the router IP in the LAN.
- WAN IP: It is the router IP in the WAN.
- Port Mapping list: The port mapping list here is the one to one relationship with the router’s port mapping setting.
- Enable Switch : It shows that the function of port mapping is enabled in this port.
- List:
 - ◇ Service name: Defined by user.
 - ◇ Protocol: Protocol type
 - ◇ Internal port: Port that has been mapped in the router.
 - ◇ External port: Port that has been mapped locally.
- Default: UPNP default port setting is the HTTP, TCP and UDP of the DVR.
- Add to the list: Click it to add the mapping relationship.
- Delete: Click it to remove one mapping item.

Double click one item; you can change the corresponding mapping information. See Figure 5-21.

Important:

When you are setting the router external port, please use 1024~5000 port. Do not use well-known port 1~255 and the system port 256~1023 to avoid conflict.

For the TCP and UDP, please make sure the internal port and external port are the same to guarantee the proper data transmission.

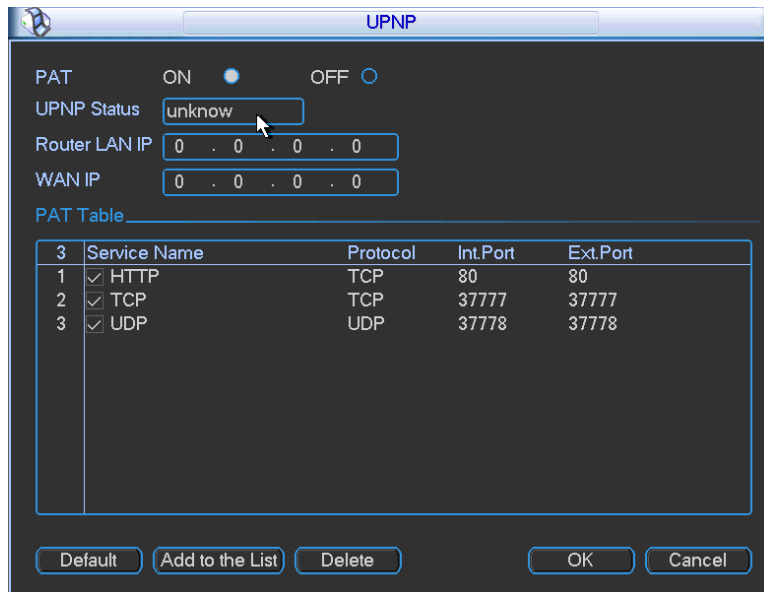

Figure 5-20

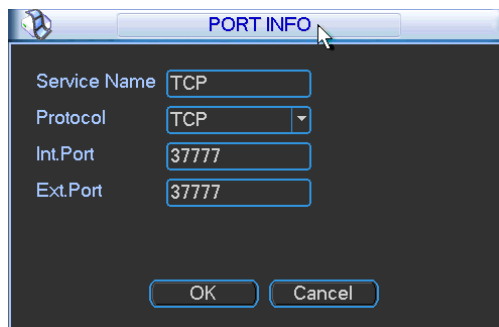

Figure 5-21

5.3.5.8 WIFI Setting

You can view the WIFI connection status in the Network Setting interface. See Figure 5-22. You can view current connection status and IP address if there is a connection.

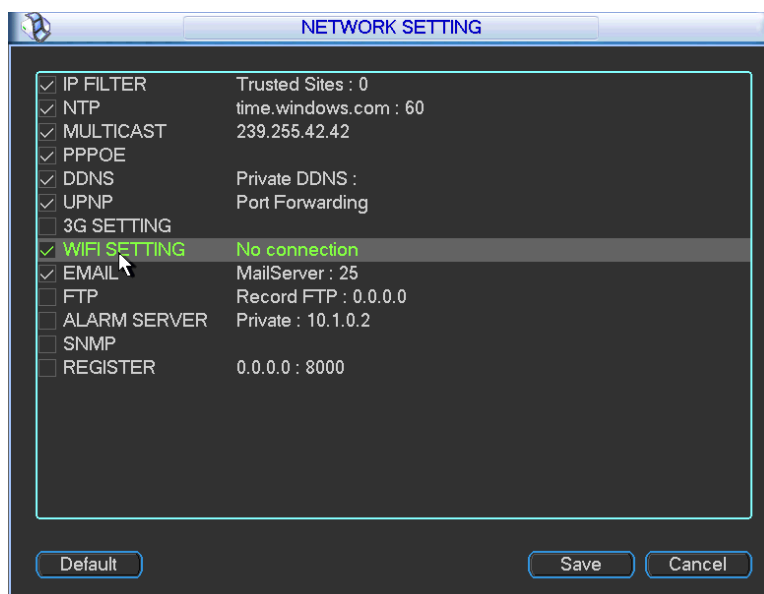

Figure 5-22

The WIFI interface is shown as below. See Figure 5-23.

- Auto connect WIFI: Check the box here, system automatically connects to the previous WIFI hotspot.
 - Refresh: You can click it to search the hotspot list again. It can automatically add the information such as the password if you have set it before.
 - Disconnect: Here you can click it to turn off the connection.
 - Connect: Here you can click it to connect to the hotspot. System needs to turn off current connection and then connect to a new hotspot if there is connection of you selected one.
- See Figure 5-24.

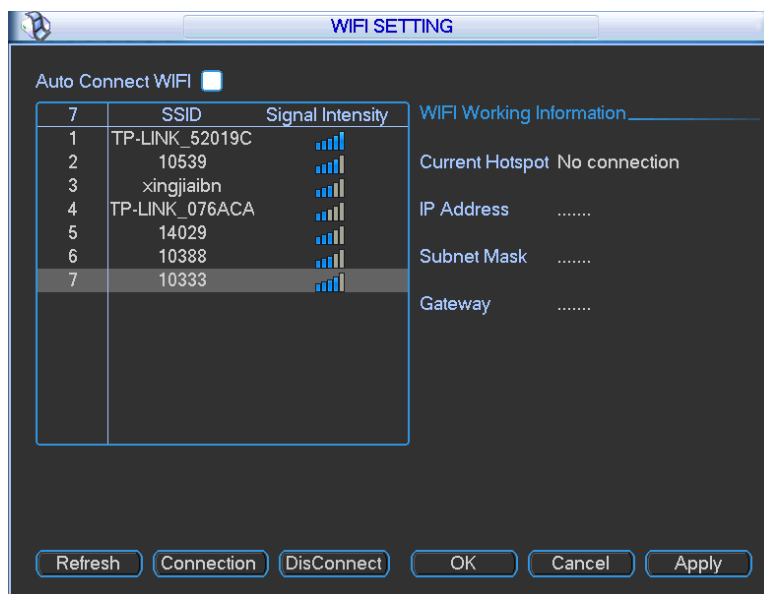

Figure 5-23

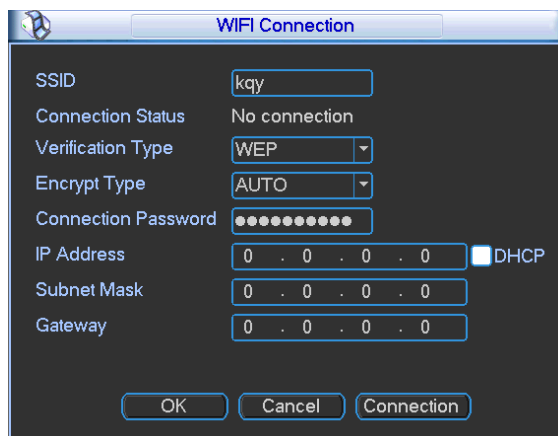

Figure 5-24

After successfully connection, you can see the following interface. You can see it is connected now. See Figure 5-24.

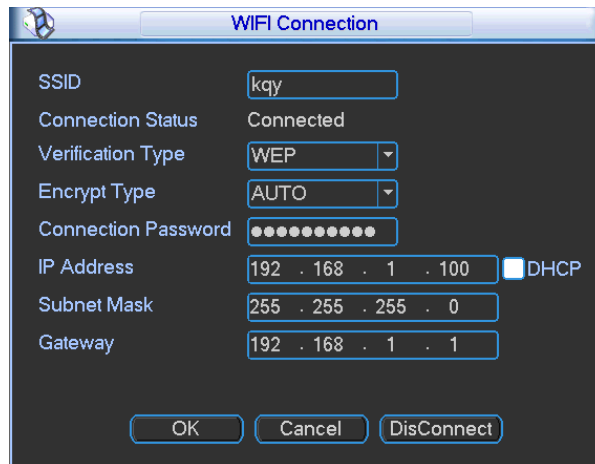

Figure 5-25

- WIFI working status: Here you can view current connection status.

Please note:

- After successful connection, you can see WIFI connection icon at the top right corner of the preview interface.
- When the hotspot verification type is WEP, system displays as AUTO since the device can not detect its encryption type.
- System does not support verification type WPA and WPA2. The display may become abnormal for the verification type and encryption type.

After device successfully connected to the WIFI, you can view the hotspot name, IP address, subnet mask, default gateway and etc. See Figure 5-26.

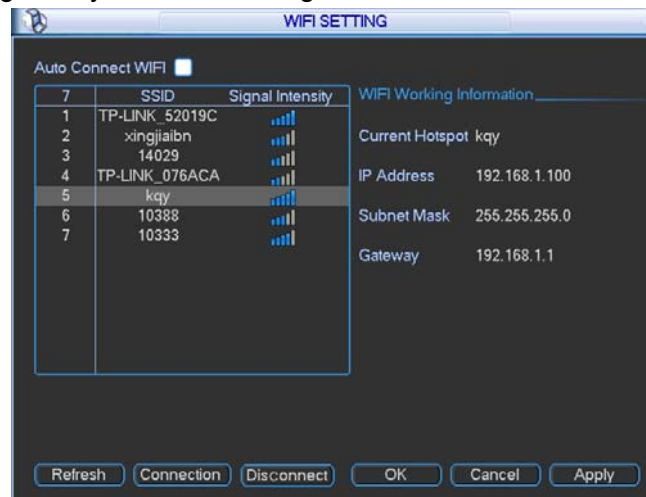

Figure 5-26

5.3.5.9 Email

The email interface is shown as below. See Figure 5-27.

- SMTP server: Please input your email SMTP server IP here.
- Port: Please input corresponding port value here.
- User name: Please input the user name to login the sender email box.
- Password: Please input the corresponding password here.
- Sender: Please input sender email box here.

- Title: Please input email subject here. System support English character and Arabic number. Max 32-digit.
- Receiver: Please input receiver email address here. System max supports 3 email boxes.
- SSL enable: System supports SSL encryption box.
- Interval: The send interval ranges from 0 to 3600 seconds. 0 means there is no interval.
- Health email enable: Please check the box here to enable this function. This function allows the system to send out the test email to check the connection is OK or not.
- Interval: Please check the above box to enable this function and then set the corresponding interval. System can send out the email regularly as you set here. Click the Test button, you can see the corresponding dialogue box to see the email connection is OK or not. See Figure 5-28.

Please note system will not send out the email immediately when the alarm occurs. When the alarm, motion detection or the abnormality event activates the email, system sends out the email according to the interval you specified here. This function is very useful when there are too many emails activated by the abnormality events, which may result in heavy load for the email server.

Figure 5-27

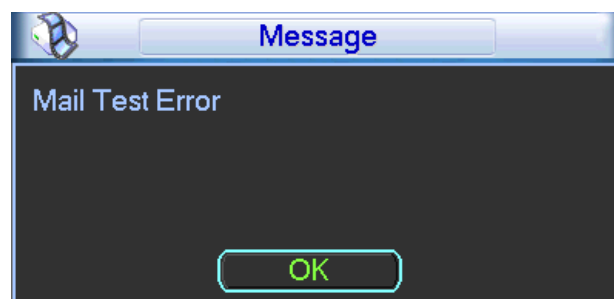

Figure 5-28

5.3.5.10 FTP

You need to download or buy FTP service tool (such as Ser-U FTP SERVER) to establish FTP service.

Please install Ser-U FTP SERVER first. From “start” -> “program” -> Serv-U FTP Server -> Serv-U Administrator. Now you can set user password and FTP folder. Please note you need to grant write right to FTP upload user. See Figure 5-29.

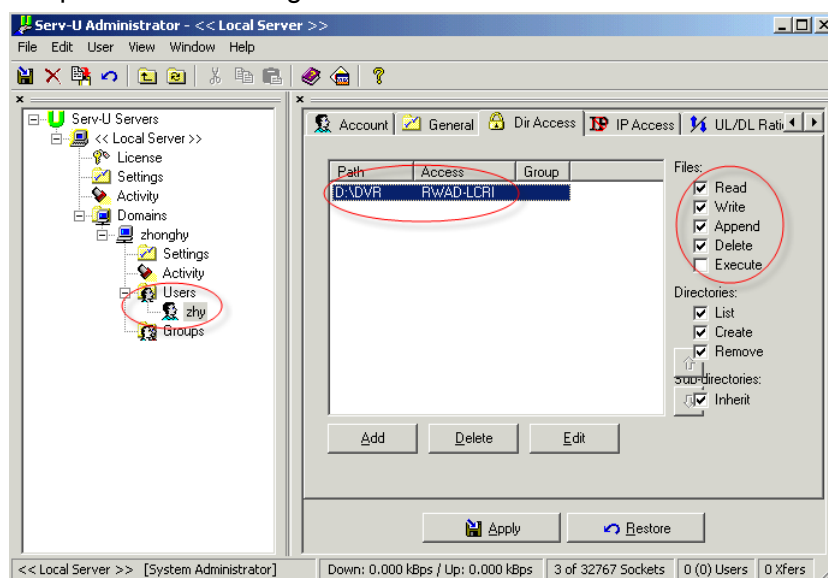

Figure 5-29

You can use a PC or FTP login tool to test setup is right or not.

For example, you can login user ZHY to [FTP://10.10.7.7](ftp://10.10.7.7) and then test it can modify or delete folder or not. See Figure 5-30.



Figure 5-30

System also supports upload multiple DVRs to one FTP server. You can create multiple folders under this FTP.

In Figure 5-209, select FTP and then double click mouse. You can see the following interface. See Figure 5-31.

- Please highlight the icon  in front of Enable to activate FTP function.
- Here you can input FTP server address, port and remote directory. When remote directory is null, system automatically create folders according to the IP, time and channel.
- User name and password is the account information for you to login the FTP.
- Now you can set upload file length, picture upload interval, upload file channel, time and type.
 - ✧ File length is upload file length. When setup is larger than the actual file length, system will upload the whole file. When setup here is smaller than the actual file length, system

only uploads the set length and auto ignore the left section. When interval value is 0, system uploads all corresponding files.

- ✧ At the same time, you can set two periods, three record files for different channels.
- Click the Test button, you can see the corresponding dialogue box to see the FTP connection is OK or not. See Figure 5-32.

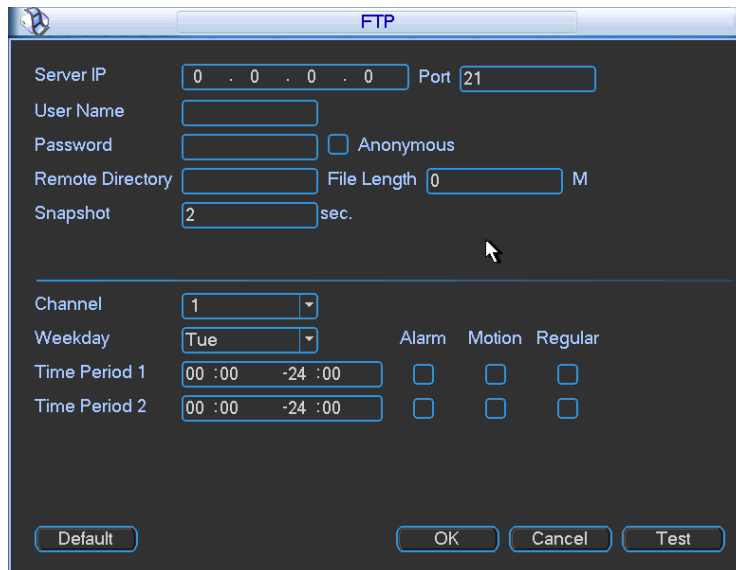

Figure 5-31

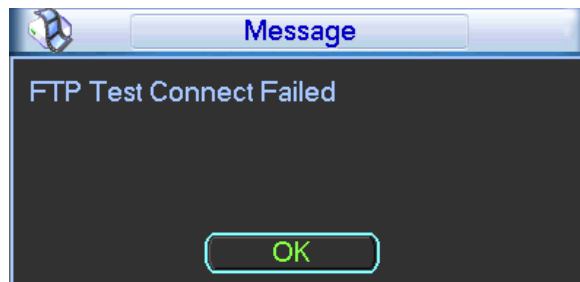

Figure 5-32

5.3.5.11 Alarm Centre

This interface is reserved for you to develop.

5.3.5.12 SNMP

SNMP is an abbreviation of Simple Network Management Protocol. It provides the basic network management frame of the network management system. The SNMP widely used in many environments. It is used in many network device, software and system.

You can set in the following interface. See Figure 5-33.

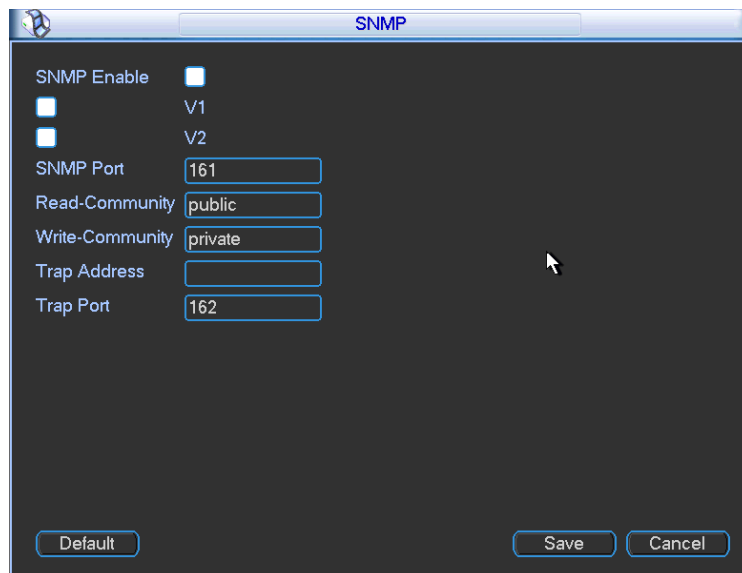

Figure 5-33

Please enable the SNMP function. Use the corresponding software tool (MIB Builder and MG-SOFT MIB Browser). You still need two MIB file: DAHUA-BASE-SNMP-MIB, DAHUA-DVR-SNMP-MIB) to connect to the device. You can get the device corresponding configuration information after successfully connection.

Please follow the steps listed below to configure.

- In Figure 5-33, check the box to enable the SNMP function. Input the IP address of the PC than is running the software in the Trap address. You can use default setup for the rest items.
- Compile the above mentioned two MIB file via the software MIB Builder.
- Run MG-SOFT MIB Browser to load the file from the previous step to the software.
- Input the device IP you want to manage in the MG-SOFT MIB Browser. Please set the corresponding version for your future reference.
- Open the tree list on the MG-SOFT MIB Browser; you can get the device configuration. Here you can see the device has how many video channels, audio channels, application version and etc.

5.3.5.13 Auto register

This function allows the device to auto register to the proxy you specified. In this way, you can use the client-end to access the DVR and etc via the proxy. Here the proxy has a switch function. In the network service, device supports the server address of IPv4 or domain.

Please follow the steps listed below to use this function.

Please set proxy server address, port, and sub-device name at the device-end. Please enable the auto register function, the device can auto register to the proxy server.

1) The setup interface is shown as in Figure 5-34.

Important

Do not input network default port such as TCP port number.

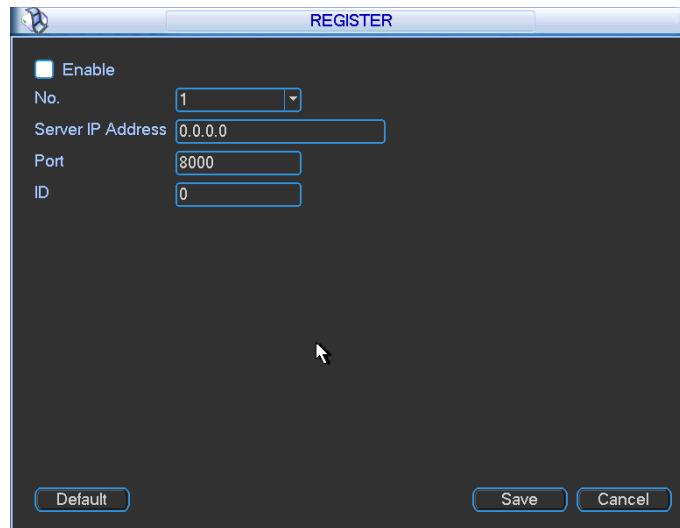

Figure 5-34

2) The proxy server software developed from the SDK. Please open the software and input the global setup. Please make sure the auto connection port here is the same as the port you set in the previous step.

3) Now you can add device. Please do not input default port number such as the TCP port in the mapping port number. The device ID here shall be the same with the ID you input in Figure 5-34. Click Add button to complete the setup.

4) Now you can boot up the proxy server. When you see the network status is Y, it means your registration is OK. You can view the proxy server when the device is online.

Important

The server IP address can also be domain. But you need to register a domain name before you run proxy device server.

5.3.6 Alarm

Please refer to chapter 4.7 Alarm Setup and Activation.

5.3.7 Detect

Please refer to chapter 4.6 Detect.

5.3.8 Pan/Tilt/Zoom

The pan/tilt/zoom setup includes the following items. Please select channel first. See Figure 5-35.

- Protocol: Select corresponding PTZ protocol such as PELCOD.
- Address: input corresponding PTZ address.
- Baud rate: Select baud rate.
- Data bit: Select data bit.
- Stop bit: Select stop bit.
- Parity: There are three choices: none/odd/even.

After completed all the setups please click save button, system goes back to the previous menu.



For detailed setup, please refer to chapter 4.10 preset/patrol/pattern/scan.



Figure 5-35

5.3.9 Display

Display setup interface is shown as below. See Figure 5-36.

- Transparency: Here is for you to adjust transparency. The value ranges from 128 to 255.
- Channel name: Here is for you to modify channel name. System max support 25-digit (The value may vary due to different series). Please note all your modification here only applies to DVR local end. You need to open web or client end to refresh channel name.
- Time display: You can select to display time or not when system is playback.
- Channel display: You can select to channel name or not when system is playback.
- Resolution: There are four options: 1280×1024(default),1280×720,1024×768,800×600. Please note the system needs to reboot to activate current setup.
- Image enhanced: Check the box; you can optimize the margin of the preview video.
- Enable tour: Activate tour function.
- Interval: System supports 1/4/8/9/16-window tour. Input proper interval value here. The value ranges from 5-120 seconds. In tour process, you can use mouse or click Shift to turn on window switch function.  Stands for opening switch function,  stands for closing switch function.
- Monitor tour type: System support 1/8-window tour.
- Alarm tour type: System support 1/8-window tour.

Please highlight icon  to select the corresponding function.

After completing all the setups please click save button, system goes back to the previous menu.

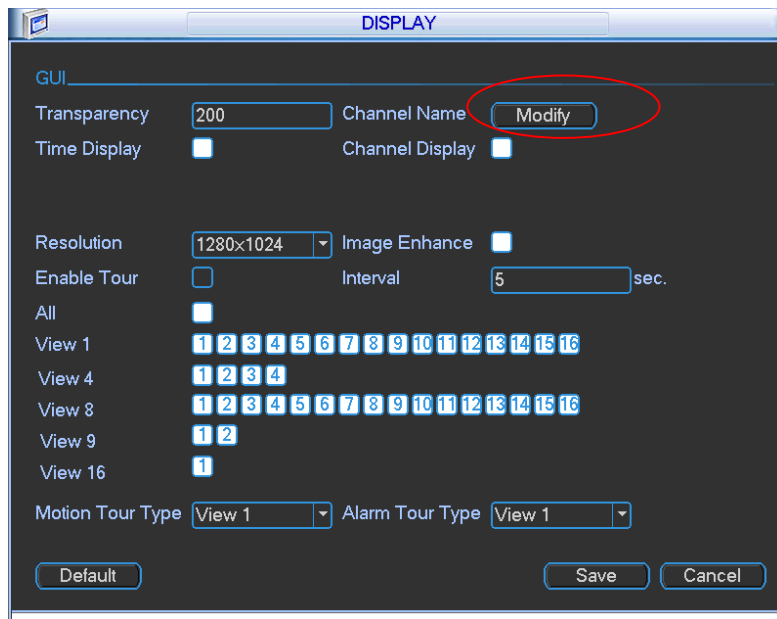

Figure 5-36

In Figure 5-36, click modify button after channel. You can see an interface is shown as in Figure 5-37. Please note all your modification here applies to local end only. You need to refresh web or client-end to get the latest channel name. System max support 25-digital character.

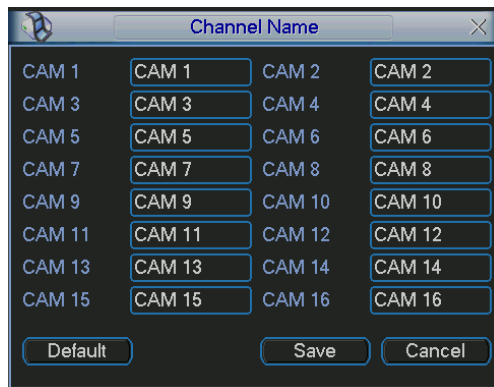



Figure 5-37

In tour mode, you can see the following interface. On the right corner, right click mouse or click shift button, you can control the tour. There are two icons:  stands for enabling window switch and  stands for disabling window function. See Figure 5-38.

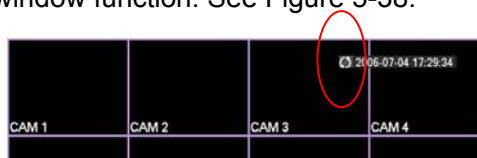



Figure 5-38

5.3.10 Default

Click default icon, system pops up a dialogue box. You can highlight  to restore default factory setup. See Figure 5-26.

- Select all
- General
- Encode
- Schedule
- RS232
- Network
- Alarm
- Detect
- Pan/tilt/zoom
- Display
- Channel name

Please highlight icon  to select the corresponding function.

After all the setups please click save button, system goes back to the previous menu.

Warning!

System menu color, language, time display mode, video format, IP address, user account will not maintain previous setup after default operation!

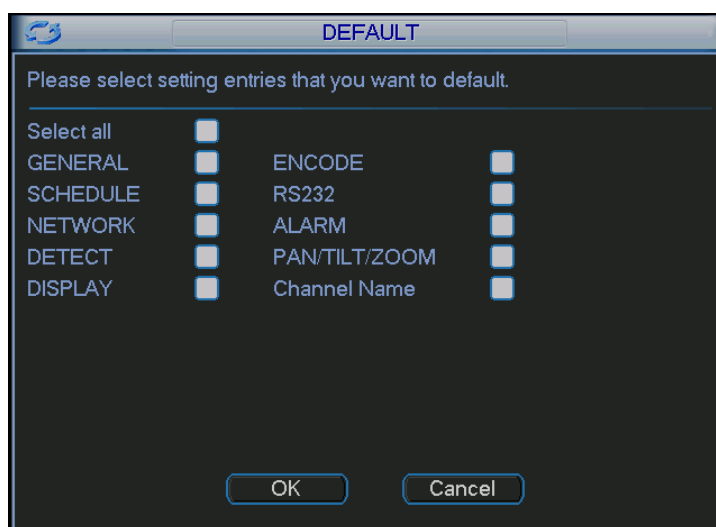

Figure 5-39

5.4 Search

Please refer to chapter 4.4 Search.

5.5 Advanced

Double click advanced icon in the main window, the interface is shown as below. See Figure 5-40. There are total eight function keys: HDD management, alarm output, abnormality, manual record, account, auto maintenance, TV adjust and video matrix.



Figure 5-40

5.5.1 HDD Management

Here is for you to view and implement hard disk management. See Figure 5-41.

You can see current HDD type, status, capacity and record time. When HDD is working properly, system is shown as O. When HDD error occurred, system is shown as X.

- Alarm set: Click alarm set button, the interface is shown as below. See Figure 5-42. (This interface is just like the abnormality setup). Please refer to chapter 5.5.2 for detailed information.
- HDD operation: You can select HDD mode from the dropdown list such as read-only or you can erase all data in the HDD. Please note system needs to reboot to get all the modification activated.

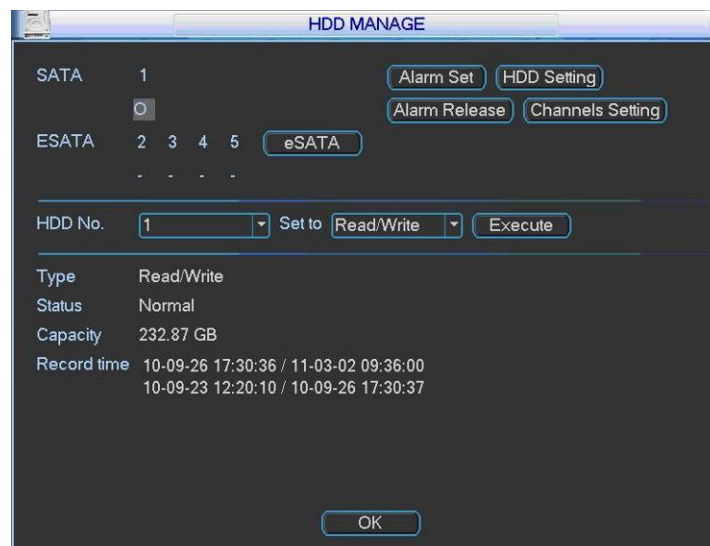

Figure 5-41

Please highlight icon  to select the corresponding function.

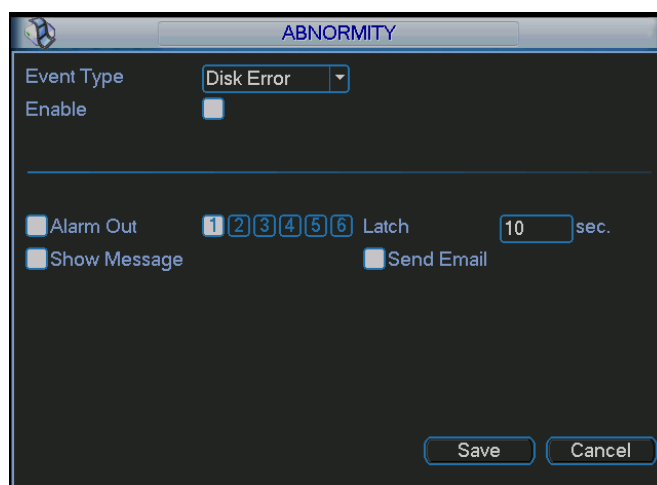

Figure 5-42

For the HDD group setup operation, please note:

- Each channel's records can be stored into the specified HDD Group.
- Each HDD Group is corresponding to several hard disks, while one hard disk is only included in one HDD Group.
- Each channel is only corresponding with one HDD Group, while one HDD Group can store records from several channels.
- HDD Group is only available for read-write HDD and self-defined disks, other types of hard disks cannot be set as HDD Group.

Important:

- Current series software version can only set the HDD group operation of the read-write HDDs. It is not for the redundancy HDD or read-only HDD.

HDD Setting

Click the button "HDD Settings" at the top right corner of the Figure 5-41, system will pop up an interface as below. See Figure 5-43.

- HDD: Here you can view the HDD amount the device can support. If there is a mark  in the front of the number, it means current position has installed a HDD.
- HDD Group: It lists the HDD Group number of current hard disk.

When you are setting the HDD Group, please check the box of the hard disk, and then choose the corresponding HDD Group number and save the settings.

Please note, one HDD is corresponding to one group, while one group can have many HDDs. The HDD group No. is corresponding HDD port, the HDD group No. may vary if you change the HDD.

In Figure 5-43, you can see the system has two working hard disks at the first and second position, and the first hard disk belongs to HDD Group 1, the second hard disk belongs to HDD Group 2.

Important

Once you change the HDD Group settings, system will reboot!



Figure 5-43

Channels Setting

Click the button named with “Channels Settings” at the top right corner of the Figure 5-41, system will pop up an interface shown as in Figure 5-44.

Channel: Here you can view the actual channel amount of the device.

Group No.:It is the SN in the HDD group management. Here we can set HDD 1 and HDD 2 sets to as HDD group 1 and HDD group 2 respectively. You can see the HDD group option has only two options 1 and 2 when you set corresponding HDD group of the channel.

When you set the channel setup, please select the corresponding channel such as 1 and 2, and then select the HDD group such as 1. Click the Save button, you can complete the setup.

In the Figure 5-44, you set channel 1 and channel 3 to the corresponding HDD group2 and set channel 2 and channel 4 to channel 16 to HDD group 1. In this setup, the records from channel 1 and channel 3 are both saved in HDD of the group 2. The records from channel 2 and channel 4 to channel 16 are all saved in HDD of the group 1.

When you are setting the configurations of the channels setting, please select relevant channels first (such as channel 1 to 16), and then select the HDD Group NO. Please click the Save button to save current setup.

Important

- Please make sure you have set HDD group for each channel, otherwise you can not save current setup!
- Once you change the HDD Group settings, system will pack the records and then reboot!

Tips

There is an easy way for you to test whether the records from the corresponding channel is saved in the specified HDD. You can remove the HDD and then check the channel can record or not. You can see the channel does not record and you can not search the previous record now.

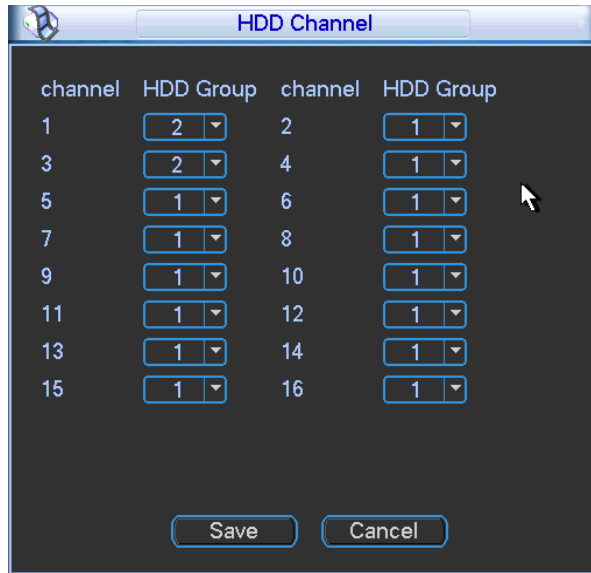

Figure 5-44

5.5.2 Abnormity

Abnormity interface is shown as in Figure 5-45.

- Event type: There are several options for you such as disk error, no disk, disconnection, IP conflict, MAC conflict and etc.
- Alarm output: Please select alarm activation output port (multiple choices).
- Latch: Here you can set corresponding delaying time. The value ranges from 10s-300s. System automatically delays specified seconds in turning off alarm and activated output after external alarm cancelled.
- Show message: system can pop up the message in the local screen to alert you when alarm occurs.
- Alarm upload: System can upload the alarm signal to the network (including alarm centre) if you enabled current function.
- Send email: System can send out email to alert you when alarm occurs.
- Buzzer: Highlight the icon to enable this function. The buzzer beeps when alarm occurs.

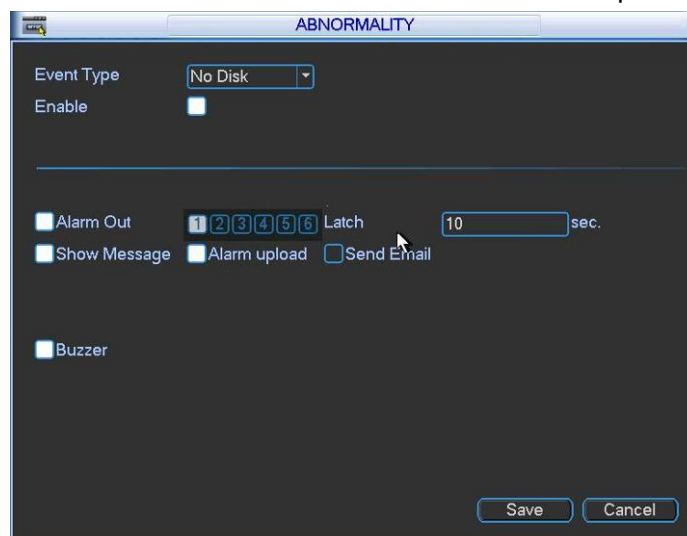



Figure 5-45

5.5.3 Alarm Output

Here is for you to set proper alarm output.

Please highlight icon  to select the corresponding alarm output.

After all the setups please click OK button, system goes back to the previous menu. See Figure 5-46.

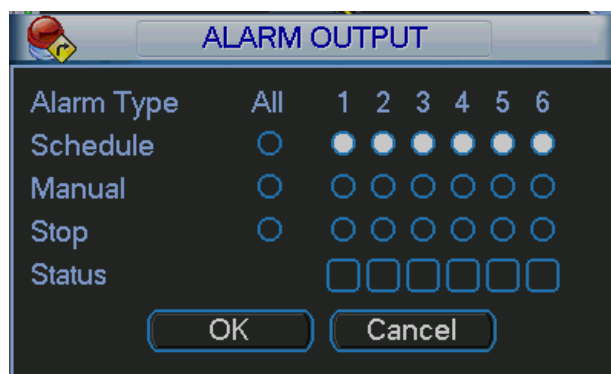

Figure 5-46

5.5.4 Manual Record

Please refer to chapter 4.3 manual record.

5.5.5 Account

Here is for you to implement account management. See Figure 5-47. Here you can:

- Add new user
- Modify user
- Add group
- Modify group
- Modify password.

For account management please note:

- For the user account name and the user group, the string max length is 6-byte. The backspace in front of or at the back of the string is invalid. There can be backspace in the middle. The string includes the valid character, letter, number, underline, subtraction sign, and dot.
- System account adopts two-level management: group and user. No limit to group or user amount.
- For group or user management, there are two levels: admin and user.
- The user name and group name can consist of eight bytes. One name can only be used once. There are four default users: admin/888888/666666 and hidden user "default". Except user 6666, other users have administrator right.
- Hidden user "default" is for system interior use only and can not be deleted. When there is no login user, hidden user "default" automatically login. You can set some rights such as monitor for this user so that you can view some channel view without login.
- One user should belong to one group. User right can not exceed group right.
- About reusable function: this function allows multiple users use the same account to login.

After all the setups please click save button, system goes back to the previous menu.

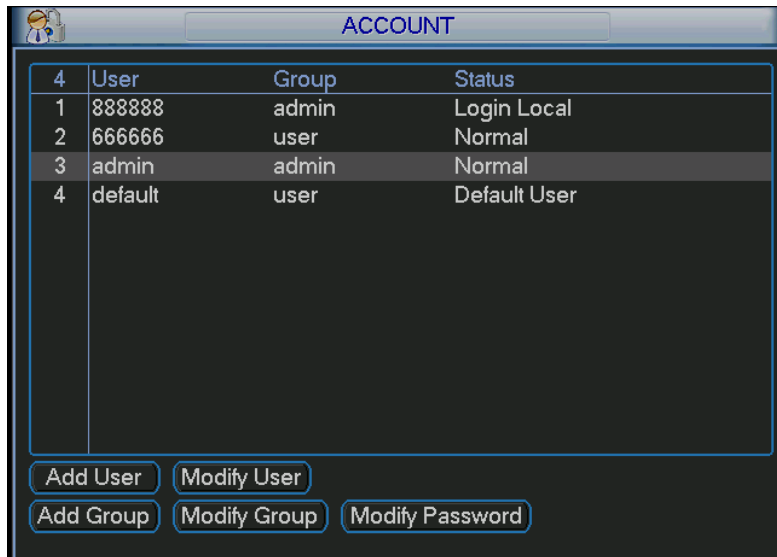

Figure 5-47

5.5.5.1 Modify Password

Click password button, the interface is shown as in Figure 5-48.

Here you can modify account password.

Please select the account from the dropdown list, input the old password and then input the new password twice. Click the Save button to confirm current modification.

For the users of user account right, it can modify password of other users.

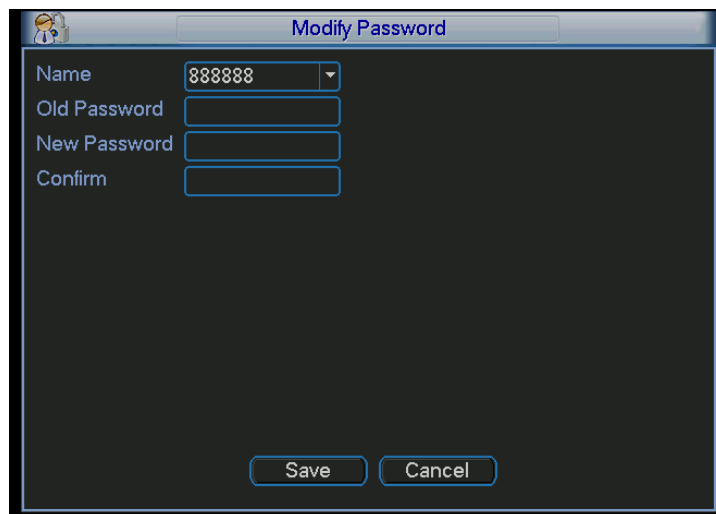

Figure 5-48

5.5.5.2 Add/Modify Group

Click add group button, the interface is shown as below. See Figure 5-49.

Here you can input group name and then input some memo information if necessary.

There are total 60 rights such as control panel, shut down, real-time monitor, playback, record, record file backup, PTZ, user account, system information view, alarm input/output setup, system setup, log view, clear log, upgrade system, control device and etc.

The modify group interface is similar to the Figure 5-49.

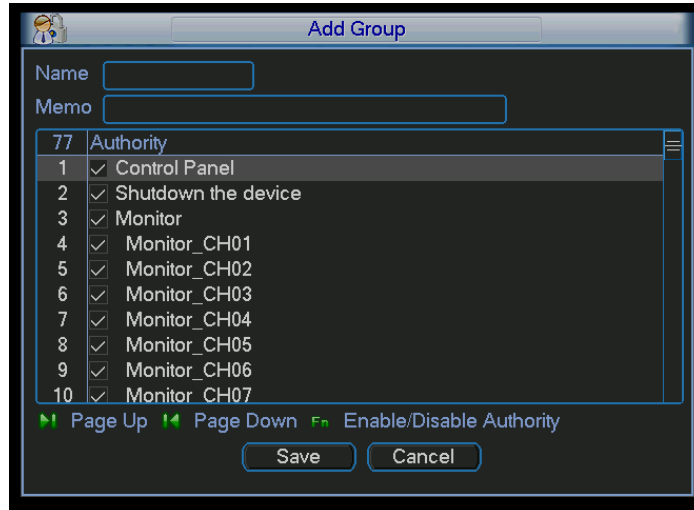

Figure 5-49

5.5.5.3 Add/Modify User

Click add user button, the interface is shown as in Figure 5-50.

Please input the user name, password, select the group it belongs to from the dropdown list.

Then you can check the corresponding rights for current user.

For convenient user management, usually we recommend the general user right is lower than the admin account.

The modify user interface is similar to Figure 5-50.

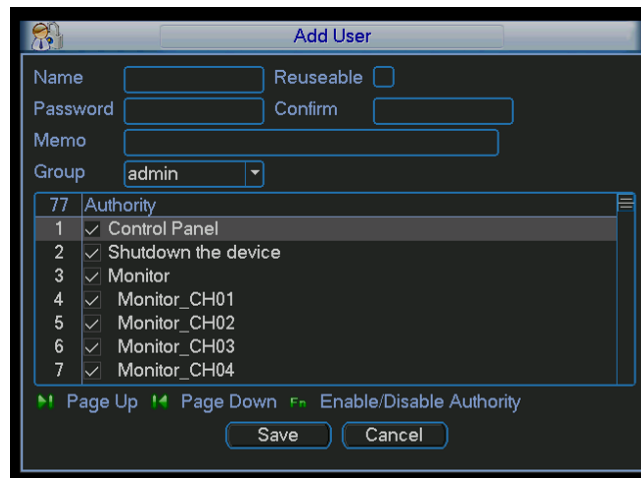

Figure 5-50

5.5.6 Auto Maintenance

Here you can set auto-reboot time and auto-delete old files setup. You can set to delete the files for the specified days. See Figure 5-51.

You can select proper setup from dropdown list.

After all the setups please click save button, system goes back to the previous menu.

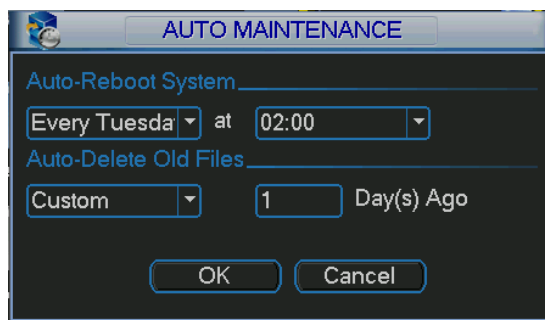

Figure 5-51

5.5.7 TV Adjust

Here is for you to adjust TV output setup. See Figure 5-52.

Please drag slide bar to adjust each item.

After all the setups please click OK button, system goes back to the previous menu.

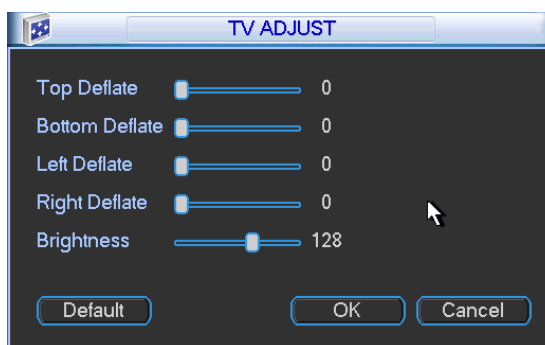

Figure 5-52

5.5.8 Video Matrix

Here you can set matrix output channel and its interval. See Figure 5-53.

It can support the 1/4/9/16-window sport tour and you can specify the interval.

Note:

- HD-SDI series product does not support this function,
- 960H series only supports single-window spot tour.

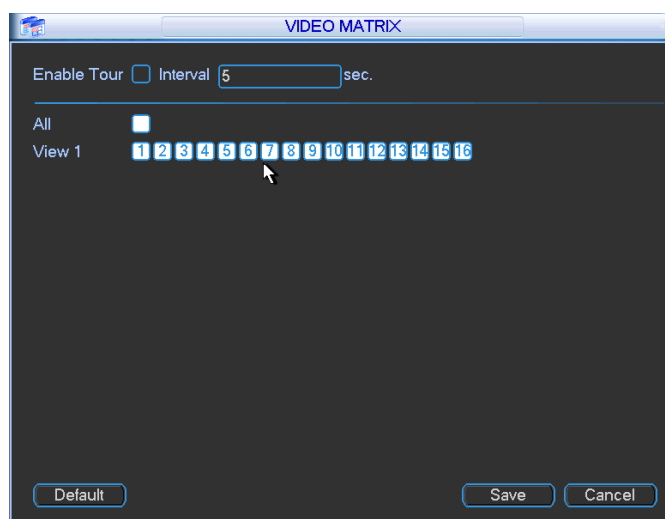

Figure 5-53

5.5.9 Card Overlay

The card overlay function is for financial areas. It includes Sniffer, information analysis and title overlay function. The Sniffer mode includes COM and network.

5.5.9.1 COM Type

The COM interface is shown as below. See Figure 5-54.

- Protocol: Please select from the dropdown list.
- Setting: Click COM setting button, the interface is shown as in RS232 interface. Please refer to Chapter 5.3.4 RS232.
- Overlay channel: Please select the channel you want to overlay the card number.
- Overlay mode: There are two options: preview and encode. Preview means overlay the card number in the local monitor video. Encode means overlay the card number in the record file.
- Overlay Position: Here you can select the proper overlay position from the dropdown list.

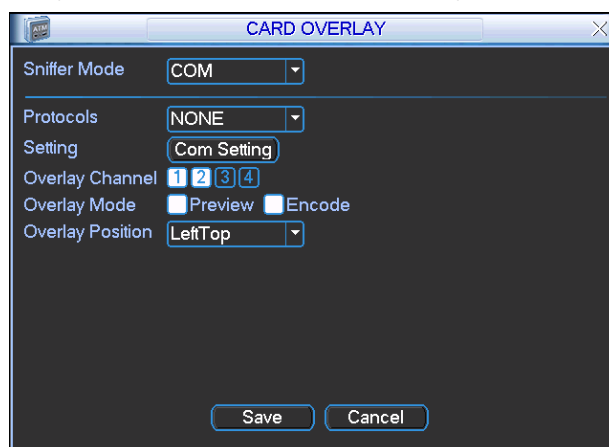

Figure 5-54

5.5.9.2 Network Type

The network type interface is shown as below. See Figure 5-55.

Here we take the ATM/POS protocol to continue.

There are two types: with or without the protocol according to client's requirements.

With the protocol

For ATM/POS with the protocol, you just need to set the source IP, destination IP (sometimes you need to input corresponding port number).

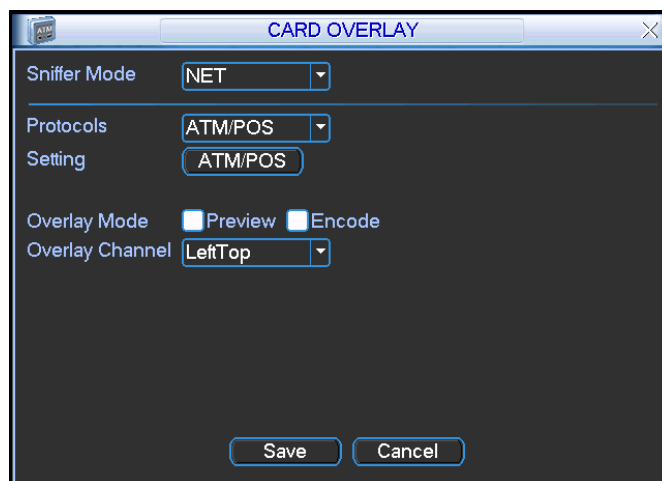

Figure 5-55

Without the protocol

For the ATM/POS without the protocol, the interface is shown as in Figure 5-56.

Source IP refers to host IP address that sends out information (usually it is the device host.)

Destination IP refers to other systems that receive information.

Usually you do not need to set source port and target port.

There are total four groups IP. The record channel applies to one group (optional) only.

Six frame ID groups verification can guarantee information validity and legal.

	StartPosition	Length	Key	
Frame ID1	1	1	bank	Data
Frame ID2	1	0		Data
Frame ID3	1	0		Data
Frame ID4	1	0		Data
Frame ID5	1	0		Data
Frame ID6	1	0		Data

Figure 5-56

Click Data button you can see an interface is shown as in Figure 5-57.

Here you can set offset value, length, title according to your communication protocol and data package. .

	StartPosition	Length	Title
Field1	5	10	card
Field2	1	0	
Field3	1	0	
Field4	1	0	

Figure 5-57

5.5.10 Config File Backup

The configuration file backup interface is shown as below. See Figure 5-58.

This function allows you to copy current system configuration to other devices.

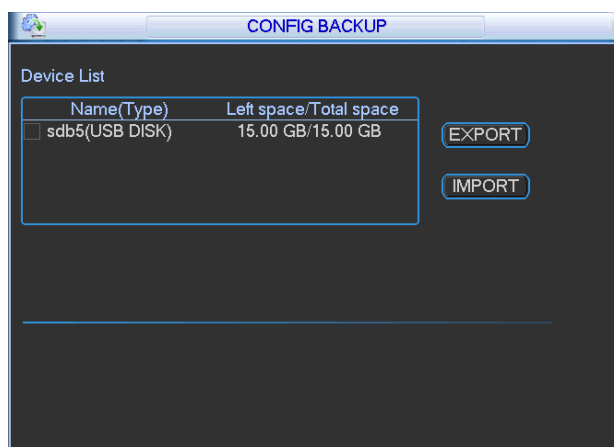

Figure 5-58

5.6 Information

Here is for you to view system information. There are total five items: HDD (hard disk information), BPS (data stream statistics), Log and version, and online user. See Figure 5-59.

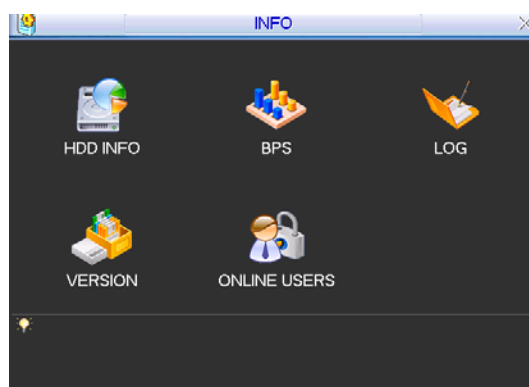

Figure 5-59

5.6.1 HDD Information

Here is to list hard disk type, total space, free space, video start time and status. See See Figure 5-60. ○ means current HDD is normal. X means there is error. - means there is no HDD.

If disk is damaged, system shows as “?”. Please remove the broken hard disk before you add a new one.

Once there is a hard disk conflict, please check hard disk time and system time is the same or not. Please go to setting then general to modify system time. At last, reboot the system to solve this problem.

After system booted up, if there is any conflict, system goes to HDD information interface directly. Please note, system does not ask you to deal with it forcedly.

When HDD conflict occurs, you can check system time and HDD time are identical or not. If they are not identical, please go to General (Chapter 5.3.1) to adjust system time or go to HDD Management (Chapter 5.5.1) to format HDD and then reboot the DVR.

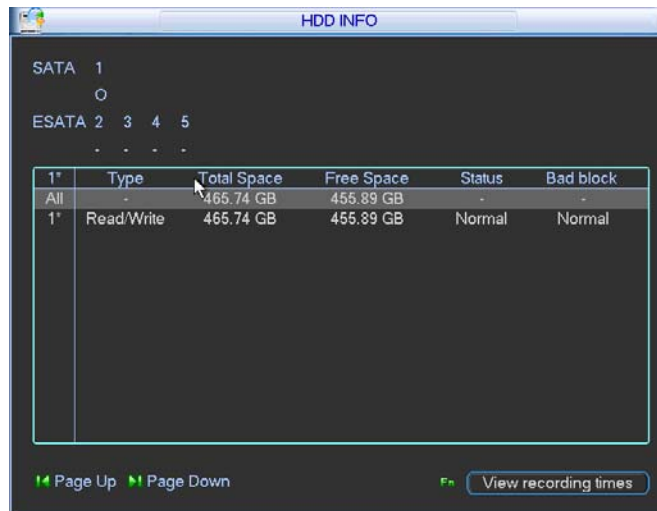

Figure 5-60

Tips:

Please click Fn button or left click mouse to view HDD record time and HDD type and time.

Double click one HDD information; you can see the HDD SMART information.

5.6.2 BPS

Here is for you to view current video data stream (KB/s) and occupied hard disk storage (MB/h). See Figure 5-61.

The screenshot shows the 'BPS' utility window. It displays a table with the following data:

Channel	Kb/S	MB/H	Wave
1	16202	5344	
2	16192	5341	
3	16192	5341	
4	16192	5341	
5	16192	5341	
6	16192	5341	
7	16192	5341	
8	16192	5341	
9	16192	5341	
10	16192	5341	
11	16192	5341	
12	16192	5341	
13	16192	5341	
14	16192	5341	
15	16192	5341	
16	16192	5341	

The 'Wave' column contains a vertical line of small green waveforms for each channel.

Figure 5-61

5.6.3 Log

Here is for you to view system log file. System lists the following information. See Figure 5-62. Log types include system operation, configuration operation, data management, alarm event, record operation, log clear and etc.

Please select start time and end time, then click search button. You can view the log files.

System max displays 100 logs in one page. It can max save 1024 log files.

Please page up/down button to view if there are more than ten files.

System also supports the backup function; you can click the backup button to save the log files in the USB devices.

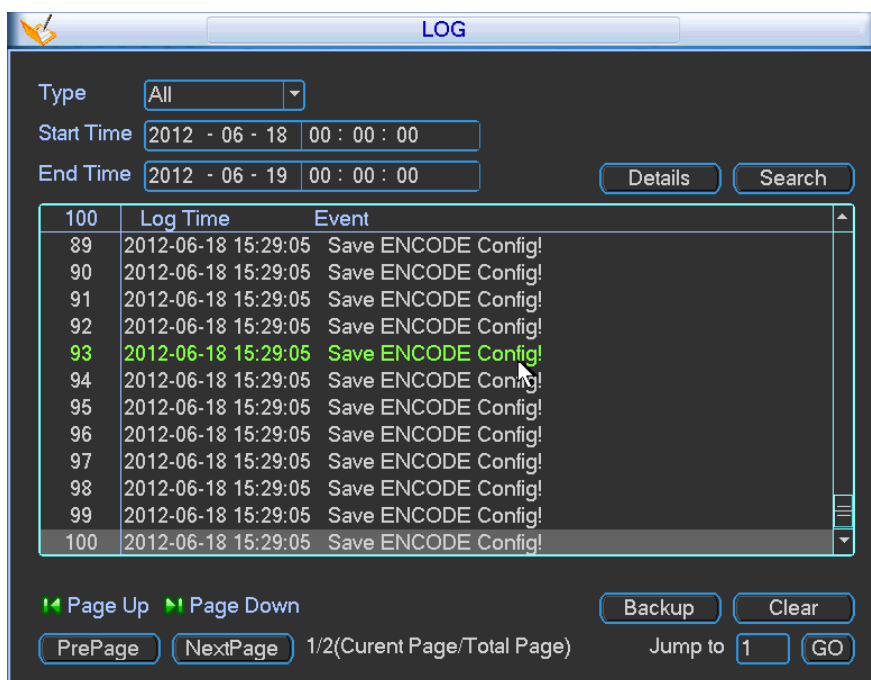

Figure 5-62

Click the Details button or double click the log item, you can view the detailed information. See Figure 5-63.

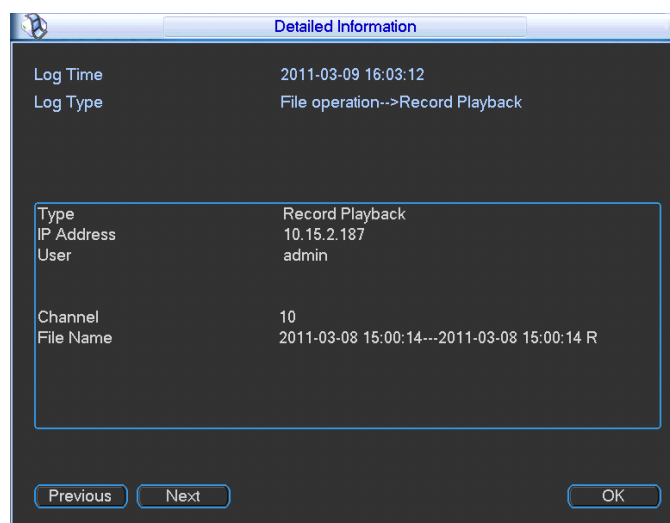

Figure 5-63

5.6.4 Version

Here is for you to view hardware features, software version, built date, release SN information and etc. You can also update system here. See Figure 5-64.

- Start: Please insert the USB device that have the update file to the device and then click the Start button to begin the update.

Important

Please make sure the upgrade file name shall be update.bin.

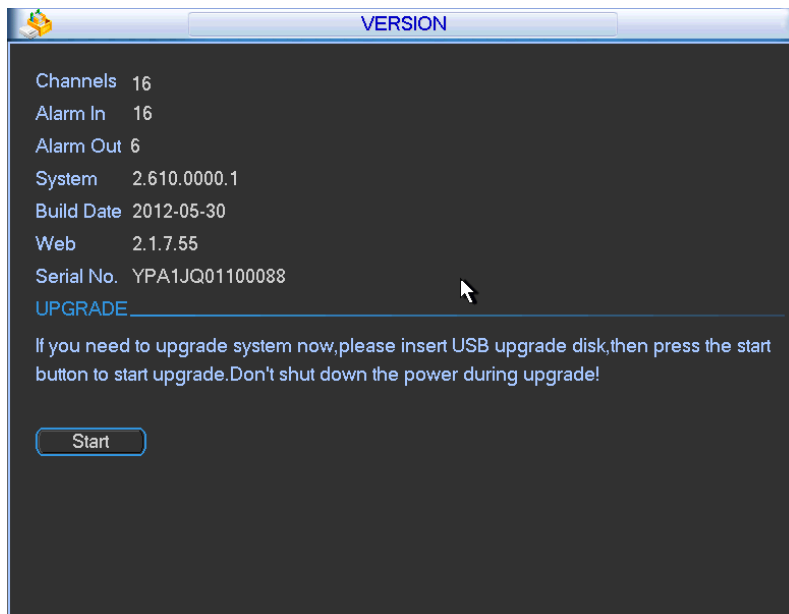

Figure 5-64

5.6.5 Online Users

Here is for you manage online users. See Figure 5-65.

You can disconnect one user or block one user if you have proper system right. Max disconnection setup is 65535 seconds.

System refreshes current interface every five seconds to detect there is any newly added or deleted user.

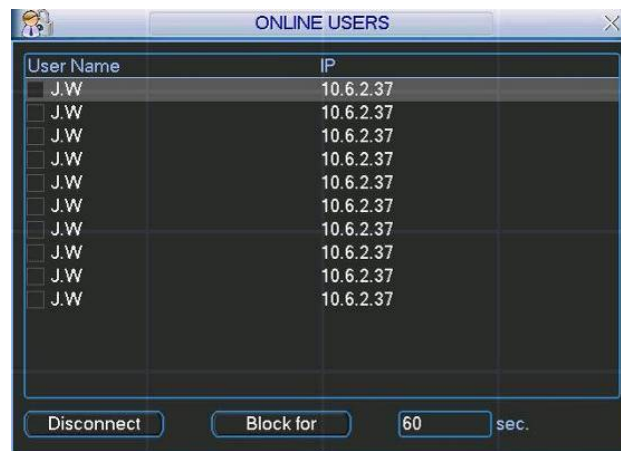

Figure 5-65

5.7 Shutdown

Double click shutdown button, system pops up a dialogue box for you to select. See Figure 5-66

- Logout menu user: log out menu. You need to input password when you login the next time.
- Restart application: reboot DVR.
- Shutdown: system shuts down and turns off power.
- Restart system: system begins rebooting.
- Switch user: you can use another account to log in.

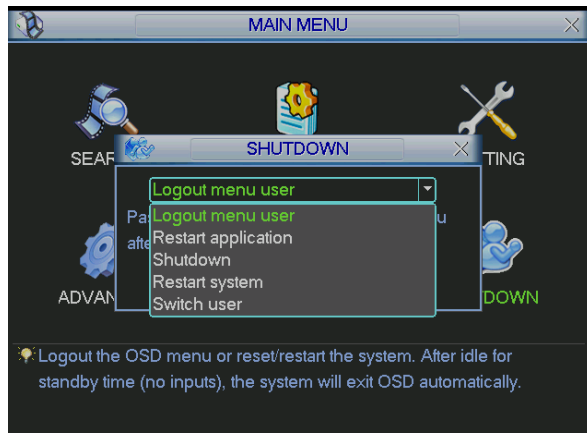

Figure 5-66

6 About Auxiliary Menu

6.1 Go to Pan/Tilt/Zoom Menu

In the one-window surveillance mode, right click mouse (click “fn” Button in the front panel or click AUX key in the remote control). The interface is shown as below: See Figure 6-1.



Figure 6-1

Click Pan/Tilt/Zoom, the interface is shown as in Figure 6-2.

Here you can set the following items:

- Zoom
- Focus
- Iris

Please click icon  and  to adjust zoom, focus and Iris.



Figure 6-2

In Figure 6-2, please click direction arrows (See Figure 6-3) to adjust PTZ position. There are totally eight direction arrows. (Please note there are only four direction arrows in DVR front panel.)



Figure 6-3

6.1.1 3D Intelligent Positioning Key

In the middle of the eight direction arrows, there is a 3D intelligent positioning key. See Figure 6-4 . Please make sure your protocol supports this function and you need to use mouse to control.

Click this button, system goes back to the single screen mode. Drag the mouse in the screen to adjust section size.



Figure 6-4

Here is a sheet for you reference.

Name	Function key	function	Shortcut key	Function key	function	Shortcut key
Zoom		Near			Far	
Focus		Near			Far	
Iris		close			Open	

6.2 Preset /Patrol / Pattern /Border Function

In Figure 6-2 click the set button. The interface is shown as below:

Here you can set the following items:

- Preset
- Patrol
- Pattern
- Border



Figure 6-5

In Figure 6-2, click page switch button, you can see an interface as in Figure 6-6.

Here you can activate the following functions:

- Preset
- Tour(Patrol)
- Pattern
- Auto scan
- Auto pan
- Flip
- Page Switch

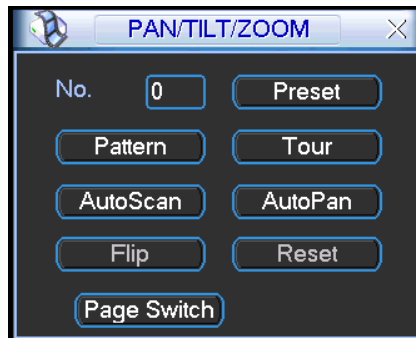

Figure 6-6

6.2.1 Preset Setup

Note: The following setups are usually operated in the Figure 6-2, Figure 6-5 and Figure 6-6.

In Figure 6-2, use eight direction arrows to adjust camera to the proper position.

In Figure 6-5, click preset button and input preset number. The interface is shown as in Figure 6-7.

Add this preset to one patrol number



Figure 6-7

6.2.2 Activate Preset

In Figure 6-6 please input preset number in the No. blank, and click preset button.

6.2.3 Patrol Setup

In Figure 6-5, click patrol button. The interface is shown as in Figure 6-8.

Input preset number and then add this preset to one patrol.



Figure 6-8

6.2.4 Activate Patrol

In Figure 6-6, input patrol number in the No. blank and click patrol button

6.2.5 Pattern Setup

In Figure 6-5, click pattern button and then click begin button. The interface shows like Figure 6-9.

Please go to Figure 6-2 to modify zoom, focus, and iris. Go back to Figure 6-9 and click end button.

You can memorize all these setups as pattern 1.



Figure 6-9

6.2.6 Activate Pattern Function

In Figure 6-6 input mode value in the No. blank, and click pattern button.

6.2.7 Border Setup

In Figure 6-5, click border button. The interface is shown as in Figure 6-10.

Please go to Figure 6-2, use direction arrows to select camera left limit, and then please go to Figure 6-10 and click left limit button

Repeat the above procedures to set right limit.



Figure 6-10

6.2.8 Activate Border Function

In Figure 6-6, click auto scan button, the system begins auto scan. Correspondingly, the auto scan button changes to stop button.

Click stop button to terminate scan operation.

6.2.9 Flip

In Figure 6-6, click page switch button, you can see an interface is shown as below. See Figure 6-11. Here you can set auxiliary function.

Click page switch button again, system goes back to Figure 6-2.

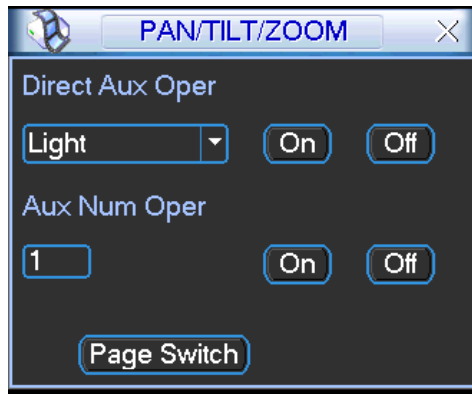

Figure 6-11

7 WEB CLIENT OPERATION

There might be slightly difference in the interface due to different series.

7.1 Network Connection

Before web client operation, please check the following items:

- Network connection is right
- DVR and PC network setup is right. Please refer to network setup(main menu->setting->network)
- Use order ping `***.***.***.***`(* DVR IP address) to check connection is OK or not. Usually the return TTL value should be less than 255.
- Open the IE and then input DVR IP address.
- System can automatically download latest web control and the new version can overwrite the previous one.
- If you want to un-install the web control, please run `uninstall webrec2.0.bat`. Or you can go to `C:\Program Files\webrec` to remove single folder. Please note, before you un-install, please close all web pages, otherwise the un-installation might result in error.
- Current series product supports various browsers such as Safari, firebox browser, Google browser. Device only support 1-channel monitor on the Apple PC.

7.2 Login

Open IE and input DVR address in the address column. For example, if your DVR IP is 10.10.3.16, then please input `http:// 10.10.3.16` in IE address column. See Figure 7-1

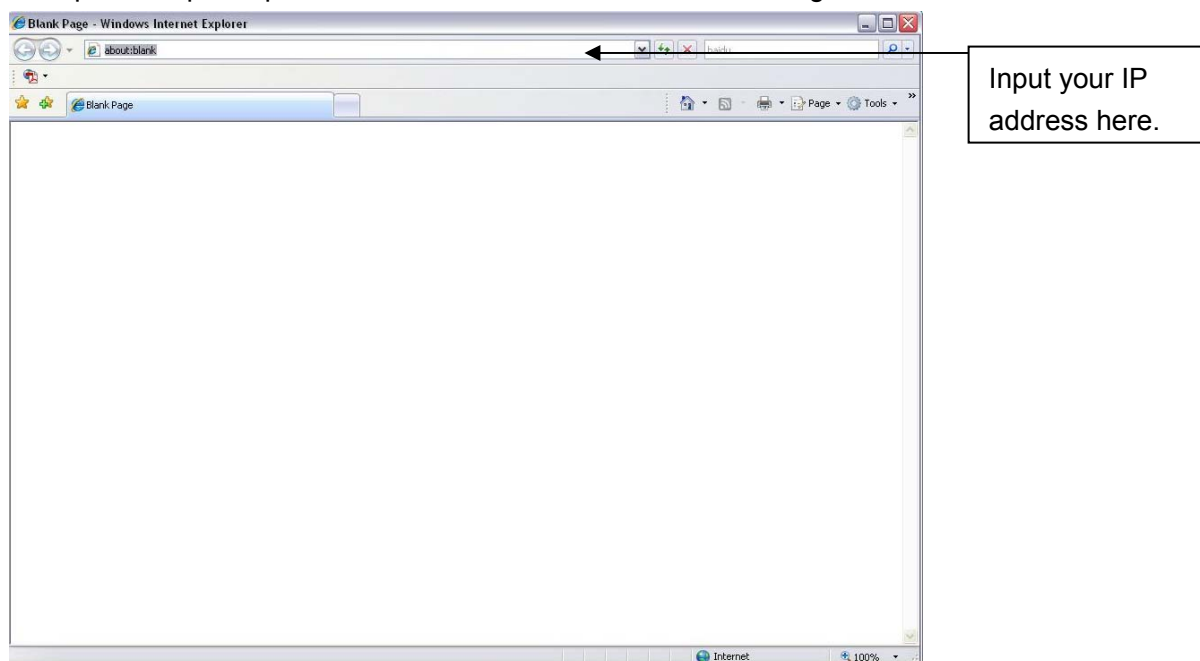

Figure 7-1

System pops up warning information to ask you whether install webrec.cab control or not. Please click yes button.

If you can't download the ActiveX file, please modify your settings as follows. See Figure 7-2.

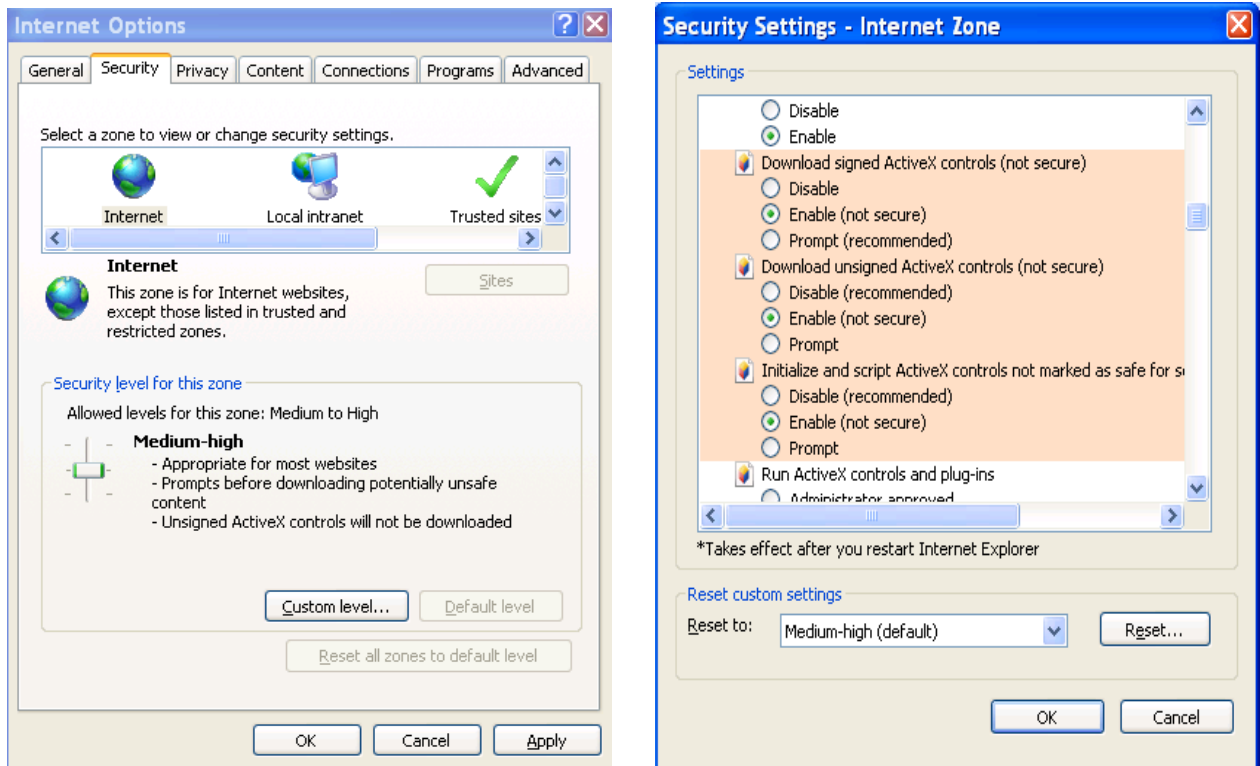

Figure 7-2

After installation, the interface is shown as below. See Figure 7-3.

Please input your user name and password.

Default factory name is **admin** and password is **admin**.

Then you can select the login mode: LAN and WAN.

Note: For security reasons, please modify your password after you first login.

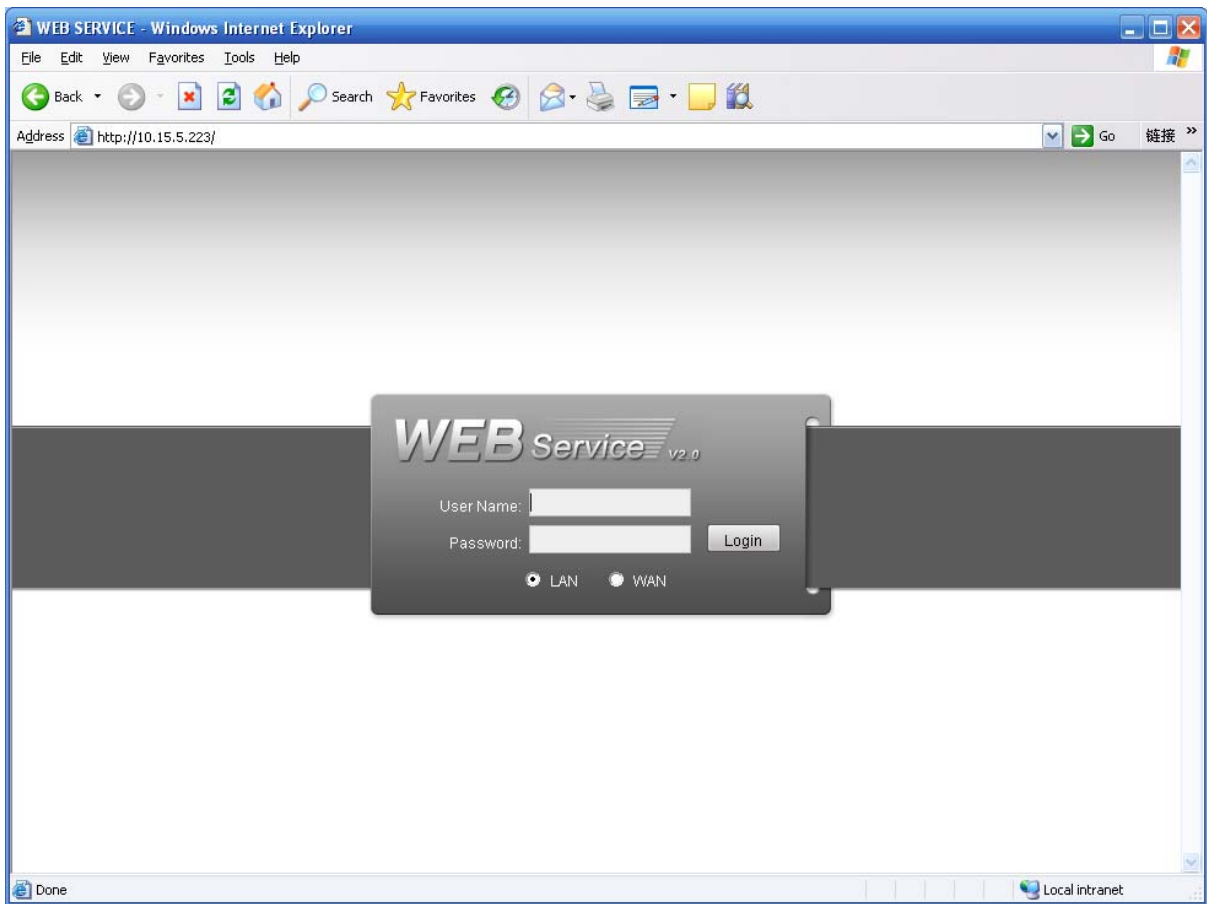

Figure 7-3

7.3 LAN Mode

For the LAN mode, after you logged in, you can see the main window. See Figure 7-6.

This main window can be divided into the following sections.

- Section 1: there are five function buttons: configuration (chapter 7.5), search (chapter 7.6), alarm (chapter 7.7), about (chapter 7.8), log out (chapter 7.9).
- Section 2: there are channel number and three function buttons: start dialog and local play, refresh.
- Section3: there are PTZ (chapter 7.3.2), color (chapter7.3.3) button and you can also select picture path and record path.
- Section 4:real-time monitor window. Please note current preview window is circled by a green rectangle zone.
- Section 5: Here you can view window switch button. You can also select video priority between fluency or real-time.
 - ◇ System monitor window switch supports full screen/1-window/4-window/6-window/8-window/9-window/13-window/16-window/20-window/25-window/36-window. See Figure 7-4.



Figure 7-4

- ❖ Preview window switch. System support 1/4/8/9/16-window real-time preview. Please you need to have the proper rights to implement preview operation. You can not preview if you have no right to preview the either channel. See Figure 7-5. Please note this series device does not support this function.



Figure 7-5



Figure 7-6

7.3.1 Real-time Monitor

In section 2, left click the channel name you want to view, you can see the corresponding video in current window.

On the top left corner, you can view device IP, channel number, network monitor bit stream.

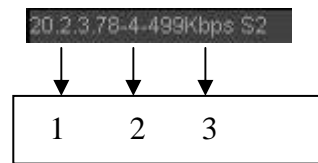

Figure 7-7

On the top right corer, there are six unction buttons. See Figure 7-8.

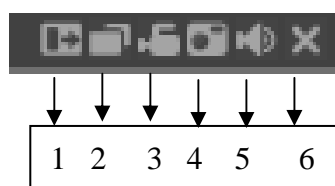

Figure 7-8

- 1: Digital zoom: Click this button and then left drag the mouse in the zone to zoom in. right click mouse system restores original status.
- 2: Change show mode: resize or switch to full screen mode.
- 3: Local record. When you click local record button, the system begins recording and this button becomes highlighted. You can go to system folder RecordDownload to view the recorded file.
- 4: Capture picture. You can snapshot important video. All images are memorized in system client folder \download\picture (default).
- 5: Audio :Turn on or off audio.(It has no relationship with system audio setup)
- 6: Close video.

Please refer to Figure 7-9 for main stream and extra stream switch information.

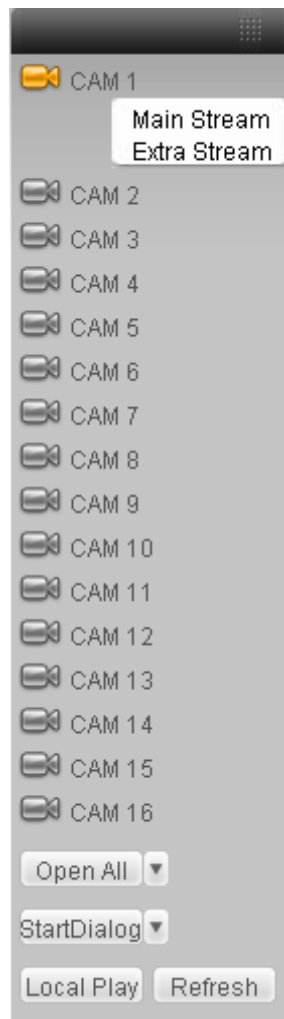

Figure 7-9

Open All

You can click it to open all channels.

Refresh

You can use button to refresh camera list.

Start Dialogue

You can click this button to enable audio talk. Click 【▼】 to select bidirectional talk mode.

There are four options: DEFAULT, G711a, G711u and PCM.

Please note, the audio input port from the device to the client-end is using the first channel audio input port. During the bidirectional talk process, system will not encode the audio data from the 1-channel.

Local Play

The Web can playback the saved (Extension name is dav) files in the PC-end.

Click local play button, system pops up the following interface for you to select local play file. See Figure 7-10.



Figure 7-10

7.3.2 PTZ

Before PTZ operation, please make sure you have properly set PTZ protocol. (Please refer to chapter 7.5.2.8 Setting-> Pan/Tilt/Zoom).

Click PTZ button, the interface is shown as in Figure 7-11.

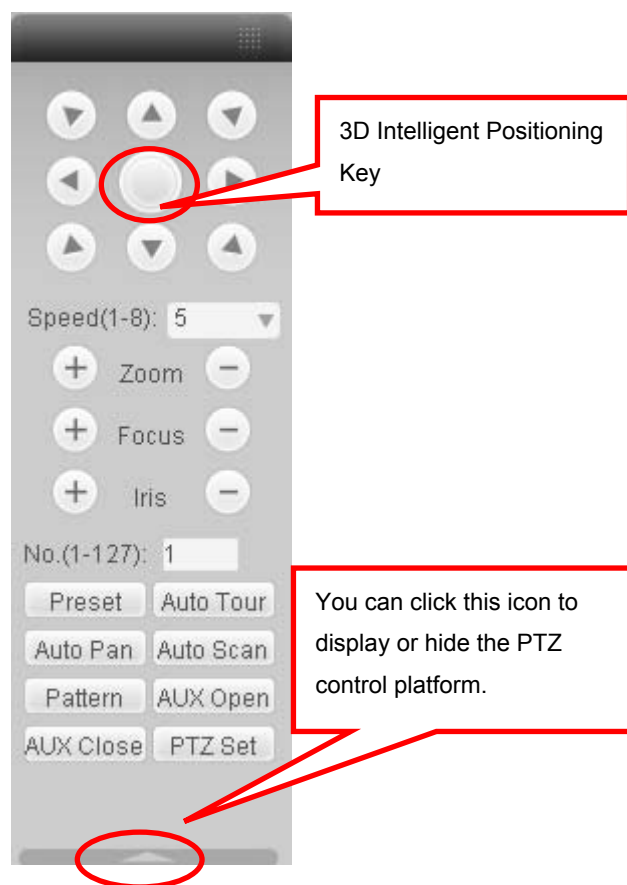

Figure 7-11

7.3.2.1 Direction key and 3D positioning key

In Figure 7-10, there are eight direction keys.

In the middle of the eight direction keys, there is a 3D intelligent positioning key.

Click 3D intelligent positioning key, system goes back to the single screen mode. Drag the mouse in the screen to adjust section size. It can realize PTZ automatically.

7.3.2.2 Speed

System supports eight-level speed. You can select from the dropdown list. Speed 2 is faster than speed 1.

7.3.2.3 Zoom/Focus/Iris

Here is a sheet for you reference.

Name	Function key	Function	Function key	Function
Zoom		Near		Far
Focus		Near		Far
Iris		close		Open

In Figure 7-11, click PTZ setup button you can see the following interface. See Figure 7-12.

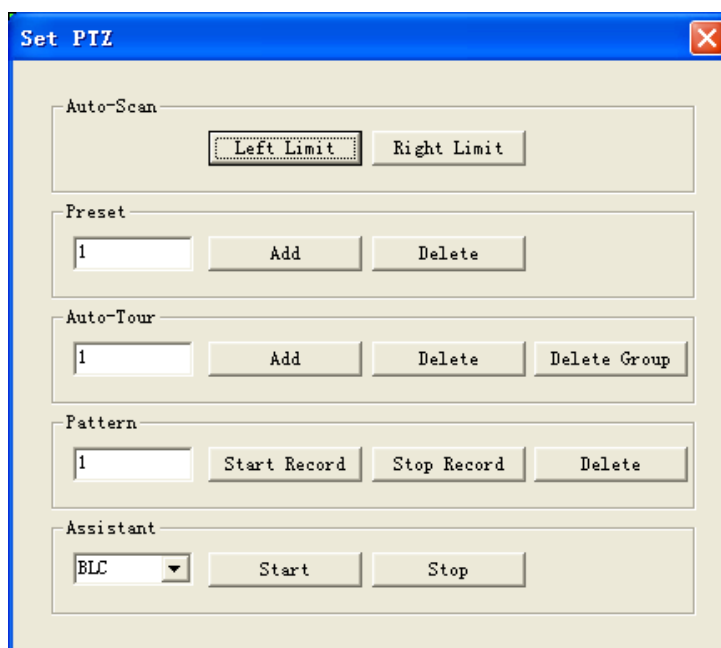

Figure 7-12

7.3.2.4 Auto Scan

In Figure 7-12, move the camera to you desired location and then click left limit button. Then move the camera again and then click right limit button to set a right limit.

7.3.2.5 Pattern

In Figure 7-12, you can input pattern value and then click start record button to begin PTZ movement. Please go back to Figure 7-11 to implement camera operation. Then you can click stop record button. Now you have set one pattern.

7.3.2.6 Preset

In Figure 7-12, move the camera to your desired location and then input preset value. Click add button, you have set one preset.

7.3.2.7 Auto tour

In Figure 7-12, input auto tour value and preset value. Click add button, you have added one preset in the tour.

Repeat the above procedures you can add more presets in one tour.

7.3.2.8 Assistant

You can select the assistant item from the dropdown list. See Figure 7-13.

7.3.2.9 Matrix

This series product supports matrix extension function. You can control the video input and output switch

7.3.2.10 Light and wiper

If your PTZ protocol supports the light and wiper control function. You can enable/disable the light or the wiper.

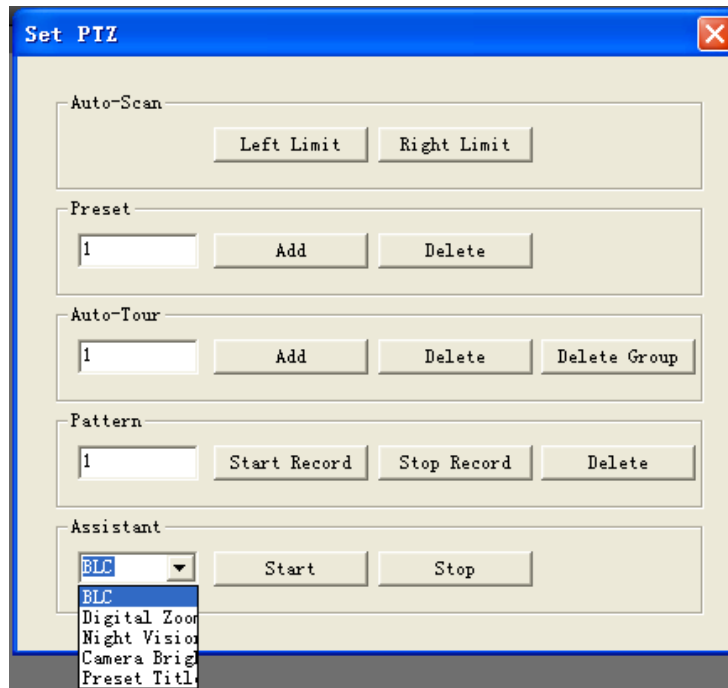

Figure 7-13

7.3.3 Color

Click color button in section 3, the interface is shown as Figure 7-14.

Here you can select one channel and then adjust its brightness, contrast, hue and saturation. (Current channel border becomes green).

Or you can click default button to use system default setup.

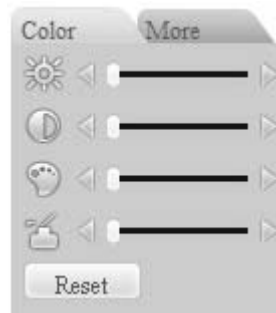

Figure 7-14

7.3.4 Picture Path and Record Path

Click more button in Figure 7-14, you can see an interface is shown as in Figure 7-15.

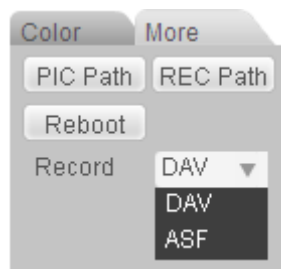

Figure 7-15

Click the record item; you can see there are two options: DAV/ASF.

Click picture path button, you can see an interface is shown as in Figure 7-16. Please click choose button to modify path.

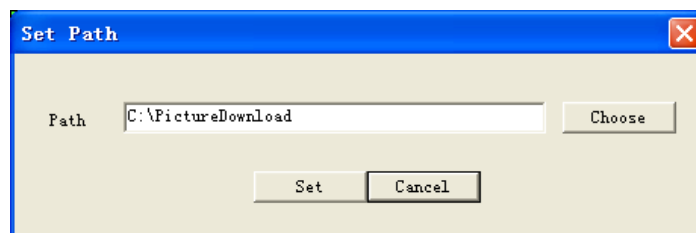

Figure 7-16

Click record path button, you can see an interface is shown as in Figure 7-17. Please click choose button to modify path.

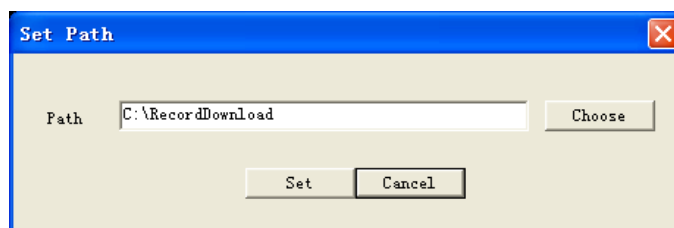

Figure 7-17

Click reboot button, system pops up the following dialogue box. See Figure 7-18, Please click OK to reboot.

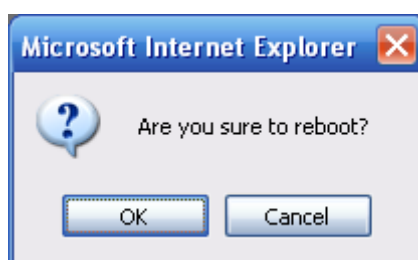

Figure 7-18

If there is local use logged in the system menu, or the Web logged in user has no right to reboot the device system pops up a dialogue box to alert you.

7.4 WAN Login

In WAN mode, after you logged in, the interface is shown as below. See Figure 7-19.

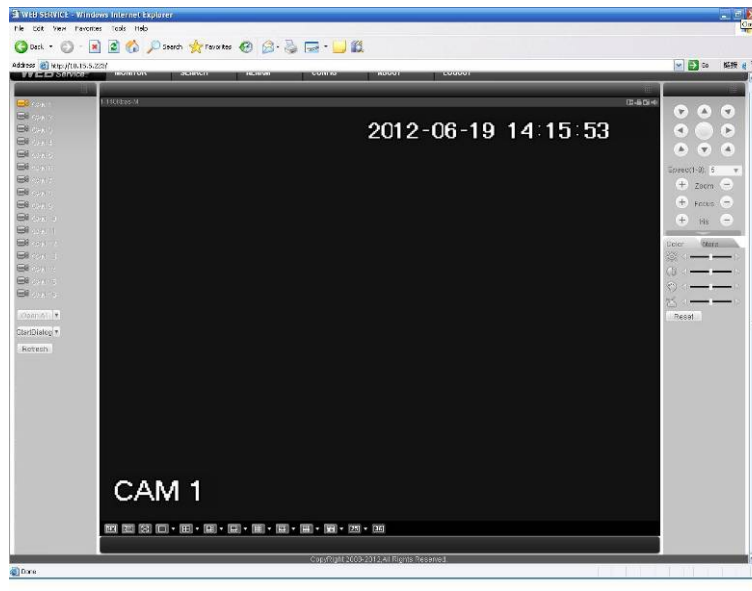

Figure 7-19

Please refer to the following contents for LAN and WAN login difference.

- 1) In the WAN mode, system opens the main stream of the first channel to monitor by default. The open/close button on the left pane is null.
- 2) You can select different channel and different monitor mode at the bottom of the interface. See Figure 7-20.

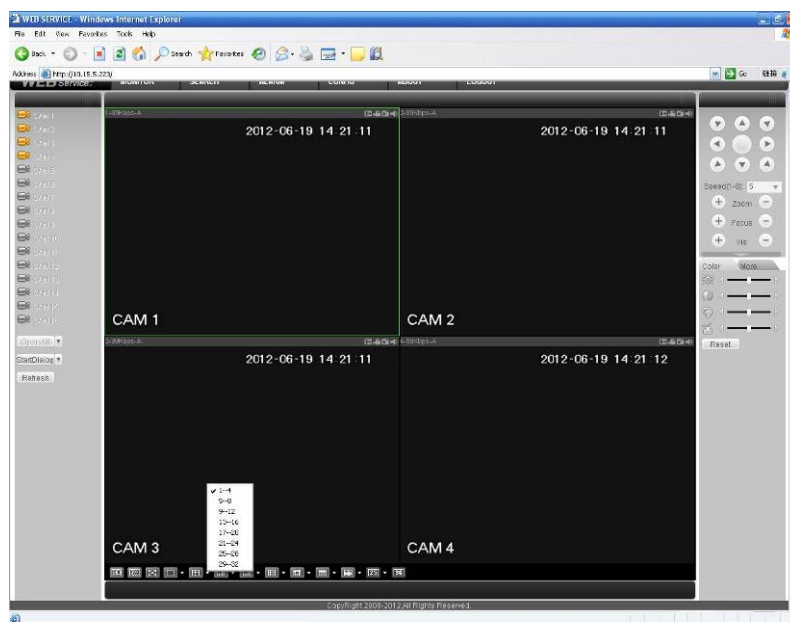

Figure 7-20

Important

The window display mode and the channel number are by default. For example, for the 16-channel, the max window split mode is 16.

- 3) Multiple-channel monitor, system adopts extra stream to monitor by default. Double click one channel, system switches to single channel and system uses main stream to monitor. You can

view there are two icon at the left top corner of the channel number for you reference. M stands for main stream. A stands for

4) When you switch from Monitor to Search or Configuration, system pops a dialogue box asking you leave current interface or not. See Figure 7-21. Click the OK button, system will close current monitor window. For example, you click the Config button when you are monitoring, system pos up a following dialogue. Click the OK button, system closes current monitor interface and open the configuration interface. The monitor interface appears automatically after you close configuration interface. When you switch from Search to the Configuration interface, system also pops up the same dialogue box for your confirmation. Click OK button, you can see system close playback interface and open the configuration interface. Please note, system will not open the playback interface again after you close the configuration interface.



Figure 7-21

5) If you login via the WAN mode, system does not support alarm activation to open the video function in the Alarm setup interface.

Important

- For multiple-channel monitor mode, system adopts extra stream to monitor by default. You can not modify manually. All channels are trying to synchronize. Please note the synchronization effect still depends on your network environments.
- For bandwidth consideration, system can not support monitor and playback at the same time. System auto closes monitor or playback interface when you are searching setup in the configuration interface. It is to enhance search speed.

7.5 Configure

7.5.1 System Information

7.5.1.1 Version Information

Here you can view device hardware feature and software version information. See Figure 7-22.

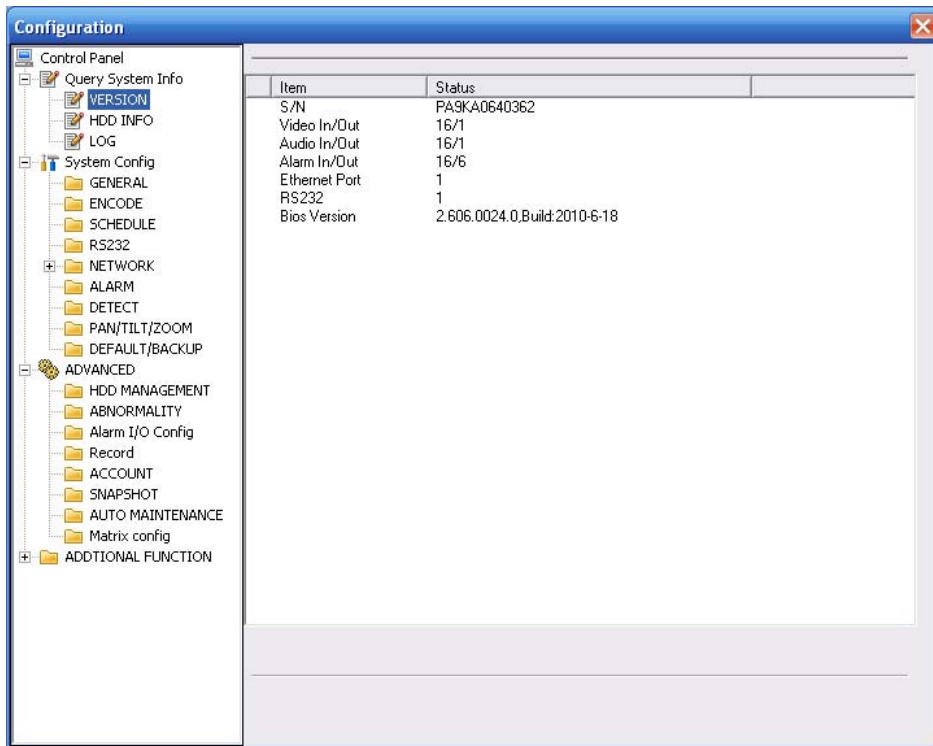

Figure 7-22

7.5.1.2 HDD information

Here you can view local storage status and network status including, free capacity and total capacity. See Figure 7-23.

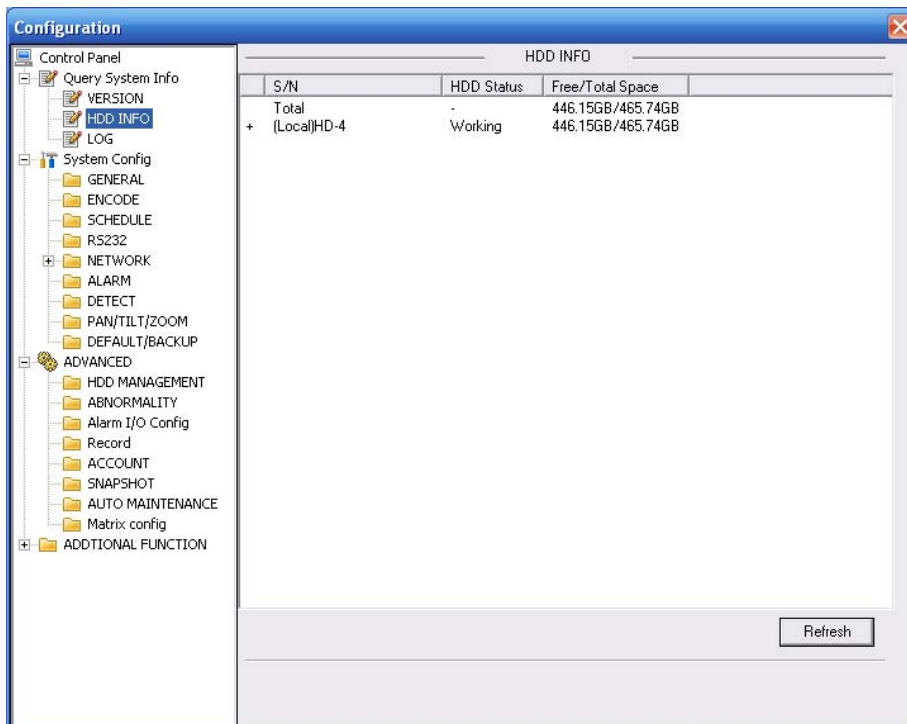

Figure 7-23

7.5.1.3 Log

Here you can view system log. See Figure 7-24.

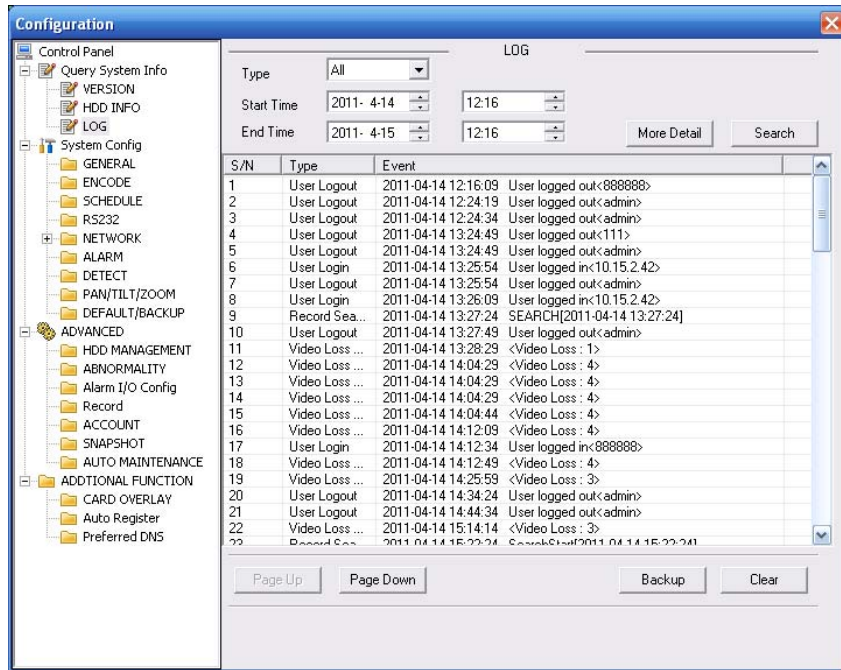

Figure 7-24

Click backup button, the interface is shown as in Figure 7-25.

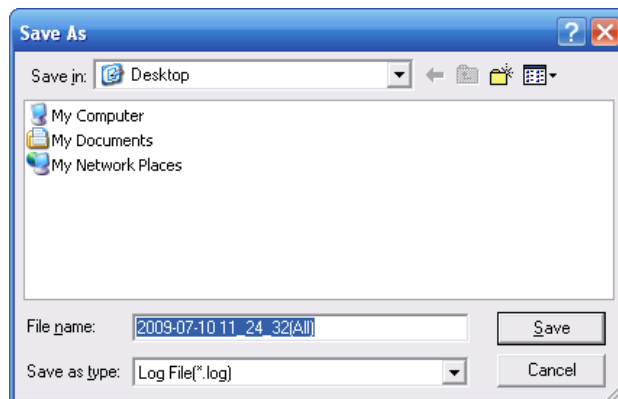

Figure 7-25

Please refer to the following sheet for log parameter information.

Parameter	Function
Type	Log types include: system operation, configuration operation, data management, alarm event, record operation, user management, log clear and file operation.
Search	You can select log type from the drop down list and then click search button to view the list.
Start time	Please input start time here.
End time	Please input the end time here.
Clear	You can click this button to delete all displayed log files. Please note system does not support clear by type.
More details	Select one item and click this button, you can view the detailed log information.

Parameter	Function
Backup	You can click this button to backup log files to current PC.

7.5.2 System Configuration

Please click save button to save your current setup.

7.5.2.1 General Setup

Here you can set system time, record length, video format and etc. See Figure 7-26.

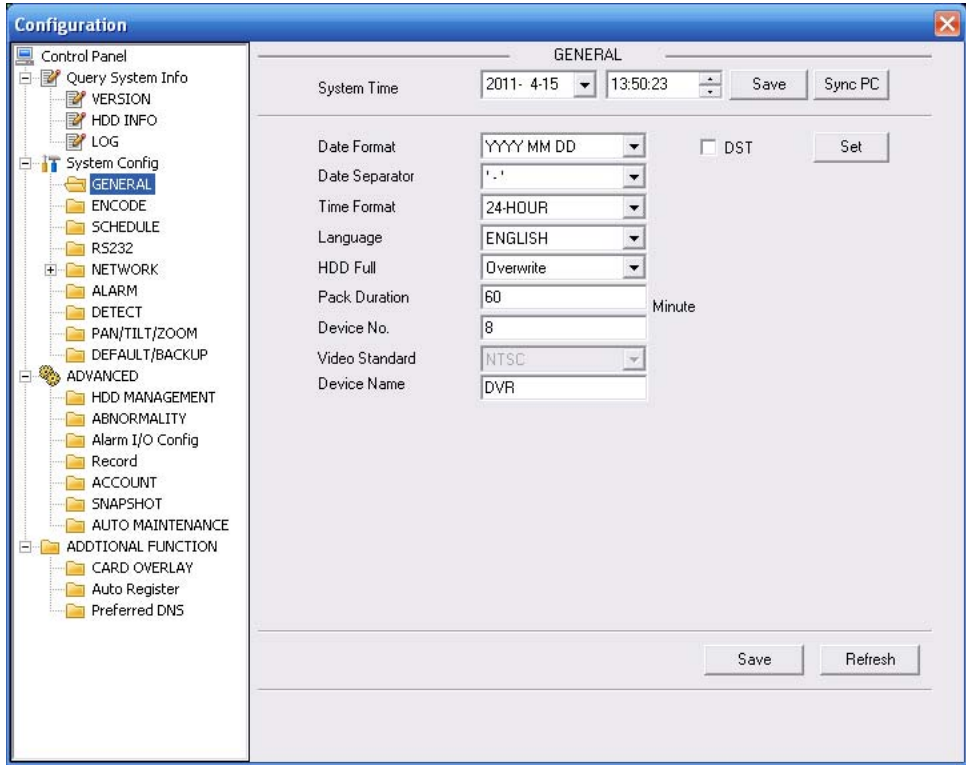

Figure 7-26

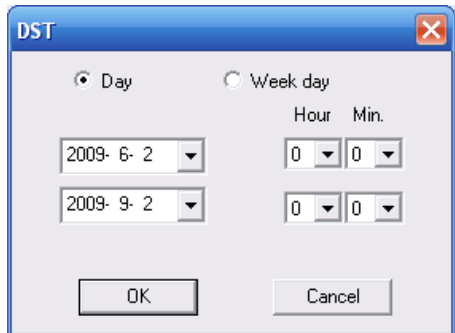

Figure 7-27

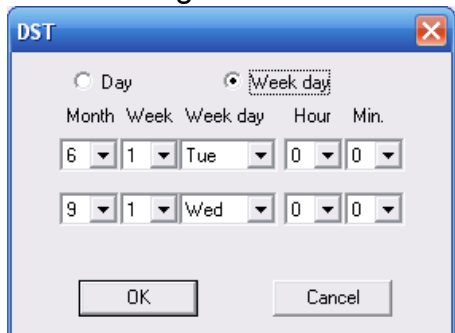

Figure 7-28

Please refer to the following sheet for detailed information.

Parameter	Function
System Time	Here is for you to modify system time. Please click Save button after your completed modification
Sync PC	You can click this button to save the system time as your PC current time.
Data Format	Here you can select data format from the dropdown list.
Data Separator	Please select separator such as – or /.
Time Format	There are two options: 24-H and 12-H.
DST	Here you can set day night save time begin time and end time. See Figure 7-27 and Figure 7-28.
Language	You can select the language from the dropdown list. Device needs to reboot to get the modification activated.
HDD Full	There are two options: stop recording or overwrite the previous files when HDD is full. When current working HDD is overwriting or it is full now, system stops record. If current working HDD is full now, system goes to overwrite the previous file.
Pack Duration	Here you can select file size. The value ranges from 1 to 120. Default setup is 60 minutes.
Video Standard	There are two options: PAL/NTSC. Please note, for the Web user, this information is for reference only. You can not modify.
Device Name	Please input the corresponding device name here.

7.5.2.2 Encode

Encode interface is shown as in Figure 7-29.

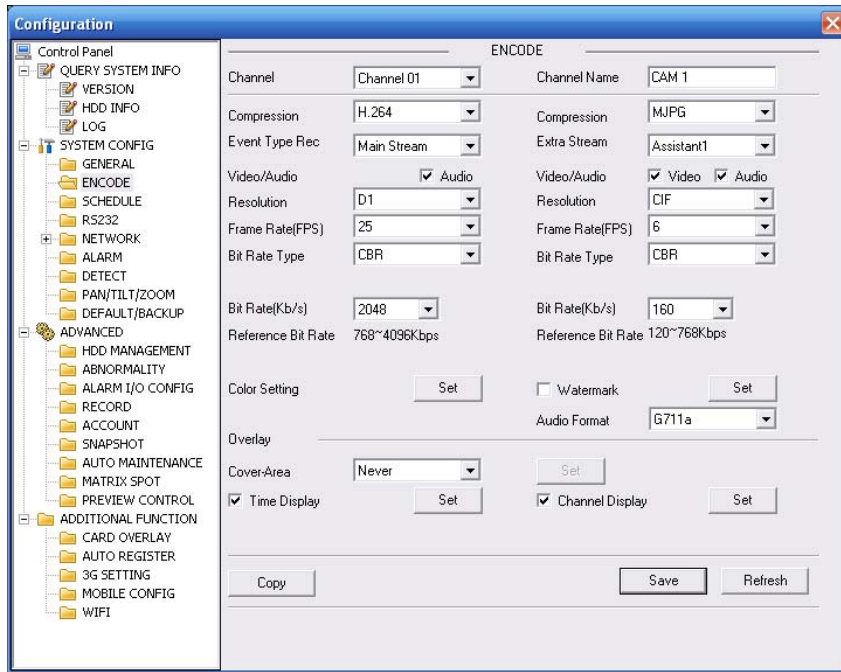

Figure 7-29

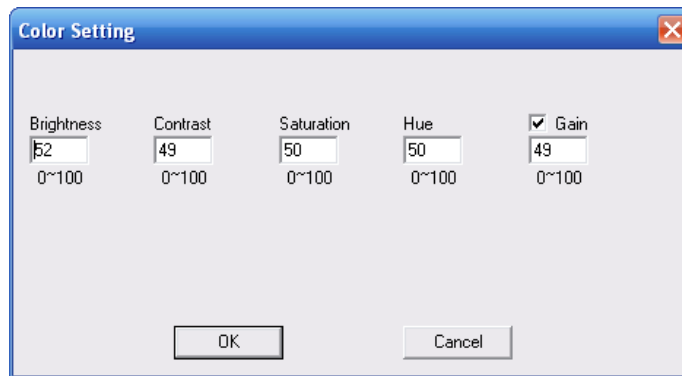

Figure 7-30

Please refer to the following sheet for detailed information.

Parameter	Function
Channel	Here is for you to select a monitor channel.
Channel Name	Here is to display current channel name. You can modify it.
Compression	The main bit stream supports H.264. The extra stream supports H.264, MJPG.
Main Stream	It includes main stream, motion stream and alarm stream. You can select different encode frame rates form different recorded events. System supports active control frame function (ACF). It allows you to record in different frame rates. For example, you can use high frame rate to record important events, record scheduled event in lower frame rate and it allows you to set different frame rates for motion detection record and alarm record.
Extra Stream	Select extra stream if you enabled the extension stream to monitor.

Parameter	Function
Audio/Video	For the main stream, recorded file only contains video by default. You need to draw a circle here to enable audio function. For extra stream, you need to draw a circle to select the video first and then select the audio if necessary.
Resolution	System supports various resolutions, you can select from the dropdown list. The main stream supports D1/HD1/2CIF/CIF/QCIF and the extra stream supports CIF/QCIF. Please note the option may vary due to different series. Note: a). For HD-SDI series, the main code-stream types are 1080P/720P/D1/HD1/2CIF/CIF/QCIF; Extra stream resolution supports D1/CIF/QCIF. b). For 960H series, the main code-stream types are 960H/D1/HD1/2CIF/CIF/QCIF; Extra stream resolution supports 960H/D1/HD1/2CIF/CIF/QCIF.
Frame Rate	PAL: 1~25f/s; NTSC: 1~30f/s. Note: For the 16-channel series product of the HD-SDI 1080P 1.5U series product and the HD-SDI 1080P 2U series product, when the main stream resolution is 1080P/720P, the frame rate of the 1/5/9/13-channel max supports 25f/s or 30f/s and the frame rate of the rest channels support 12f/s or 15f/s. The extras stream of the HD-SDI 1080P 1.5U series product and the HD-SDI 1080P 2U series product support D1 (6fps or 7f/s.)
Bit Rate Type	There are two options: VBR and CBR. Please note, you can set video quality in VBR mode only.
Quality	The value ranges from 1 to 6. The level 6 is the best video quality.
Bit Rate	<ul style="list-style-type: none"> • In CBR, the bit rate here is the max value. In dynamic video, system needs to low frame rate or video quality to guarantee the value. • The value is null in VBR mode. • Please refer to recommend bit rate for the detailed information.
Recommended Bit	Recommended bit rate value according to the resolution and frame rate you have set.
Color Setting	Here you can set video brightness, contrast ness, hue, saturation and gain. The value ranges from 0 to 100.Default value is 50. See Figure 7-30. Please note, some series devices do not support OSD transparent setup function.
Cover area (privacy mask)	<ul style="list-style-type: none"> • Here you can privacy mask the specified video in the monitor video. • One channel max supports 4 privacy mask zones. • The privacy mask includes two options: Never/monitor. Never: It means do not enable privacy mask function. Monitor: the privacy mask zone can not be viewed in monitor mode.

Parameter	Function
Time Title	<ul style="list-style-type: none"> You can enable this function so that system overlays time information in video window. OSD transparent value ranges from 0 to 255. 0 means complete transparent. Please note OSD transparent setup is form special series only. You can use the mouse to drag the time tile position.
Channel Title	<ul style="list-style-type: none"> You can enable this function so that system overlays channel information in video window. OSD transparent value ranges from 0 to 255. 0 means complete transparent. You can use the mouse to drag the channel tile position.
Copy	It is a shortcut menu button. You can copy current channel setup to one or more channels. The interface is shown as in Figure 7-28.
Save	You can click save button after you complete setup for one channel, or you can complete the whole setups and then click save button.
Refresh	Click this button to get device latest configuration information.

Click copy interface, the interface is shown as in Figure 7-31.

If you have completed the setup for channel 1, you can click 3 to copy current setup to channel 3. Or you can click 2, 3, and 4 to copy current setup to channel 2, channel 3 and channel 4.

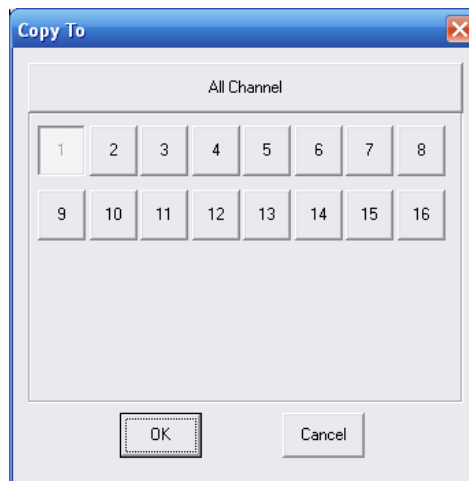

Figure 7-31

7.5.2.3 Schedule

Here you can set different periods for various days. There are max six periods in one day. See Figure 7-32.

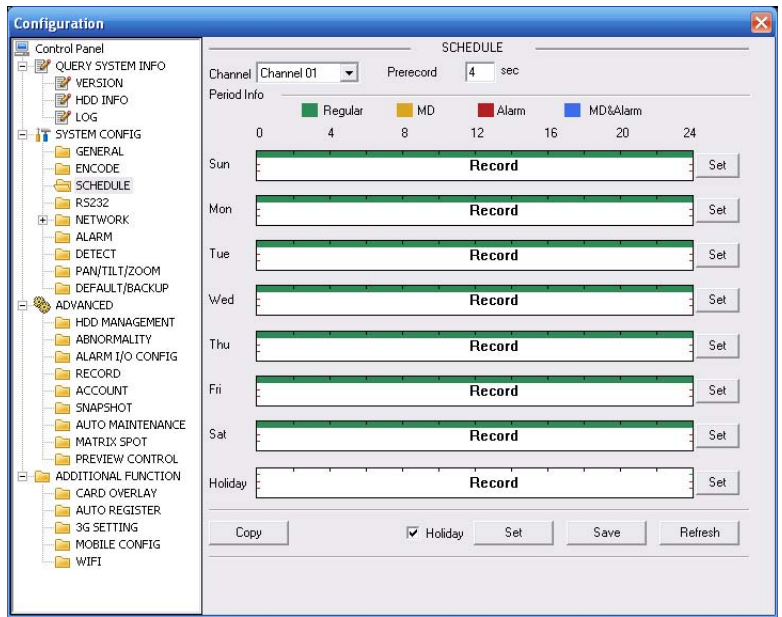

Figure 7-32

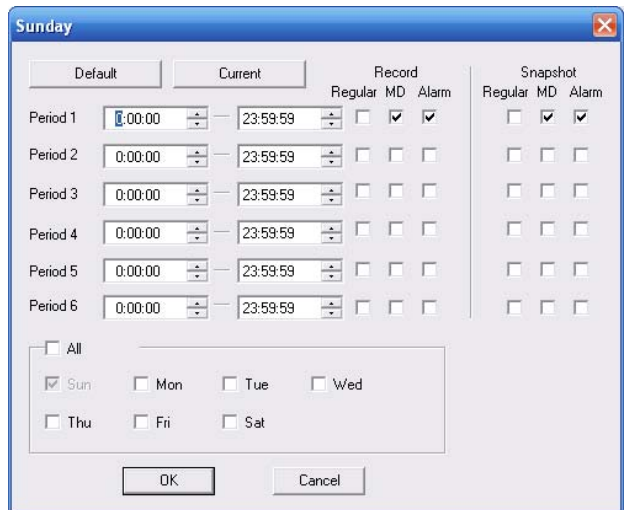

Figure 7-33

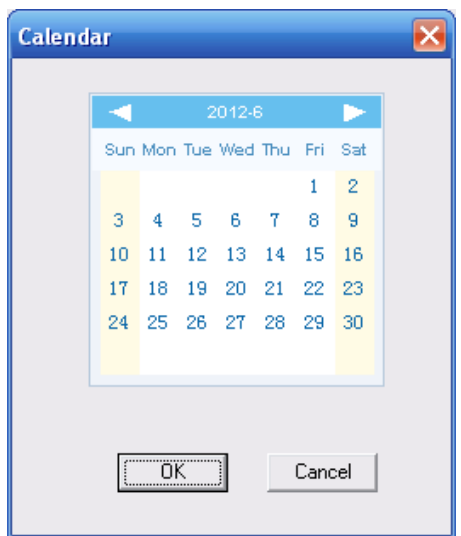

Figure 7-34

Please refer to the following sheet for detailed information.

Parameter	Function
Channel	Please select a channel first.
Pre-record	Please input pre-record value here. System can record the three to five seconds video before activating the record operation into the file. (Depends on data size).
Setup	<ul style="list-style-type: none"> • In Figure 7-32, click set button, you can go to the corresponding setup interface. See Figure 7-33. • Please set schedule period and then select corresponding record or snapshot type: schedule/snapshot, motion detection/snapshot, and alarm/snapshot. • Please select date (Current setup applies to current day by default. You can draw a circle before the week to apply the setup to the whole week.) • After complete setup, please go back to Figure 7-32 and then click save to save current time period setup.
Holiday	Click Set button, system pops up a dialogue box shown as in Figure 7-34. Here you can set holiday date. Check the box, it means current channel shall record as your holiday setup. Please go to the Period interface to set the holiday date record setup.
Copy	It is a shortcut menu button. You can copy current channel setup to one or more (all) channels. The interface is shown as in Figure 7-31.
Save	You can click save button after you complete setup for one channel, or you can complete the whole setups and then click save button.
Refresh	Click this button to get device latest configuration information.

7.5.2.4 RS232

The RS232 interface is shown as in Figure 7-35.

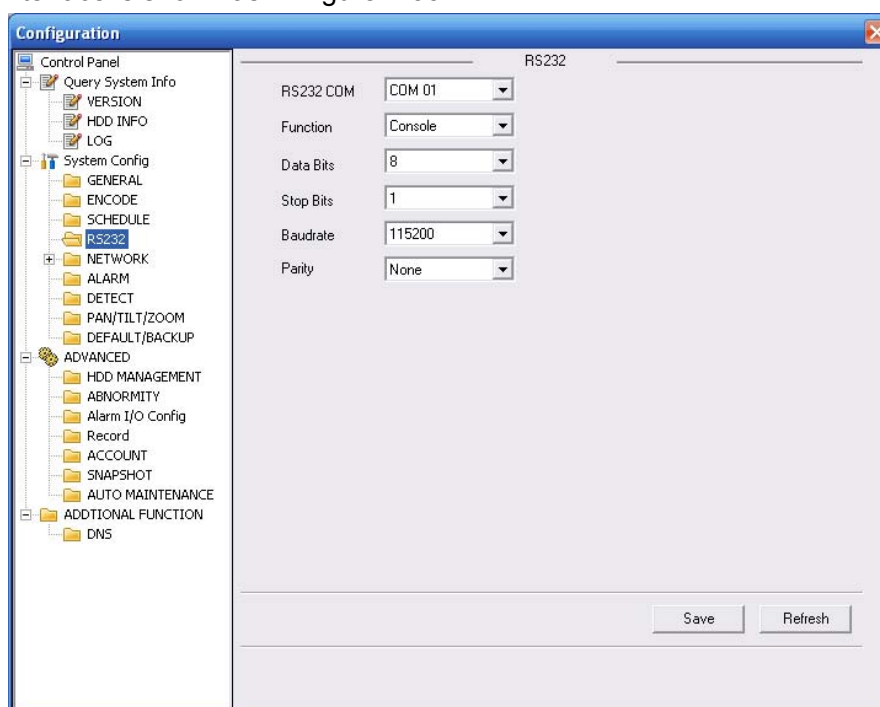

Figure 7-35

Please refer to the following sheet for detailed information.

Parameter	Function
RS232	There are two options: COM 01 and keyboard.
Function	Console is to upgrade the program or debug via COM or mini terminal software. Keyboard: COM control protocol. You can use keyboard to control DVR via COM.
Data Bit	The value ranges from 5 to 8.
Stop Bit	There are three options: 1/2.
Baud Bit	You can select corresponding baud bit here.
Parity	There are five options: none/odd/even/space/mark.

System default setup is:

- Function: Console.
- Data bit: 8
- Stop bit: 1
- Baud bit: 115200
- Parity: None.

7.5.2.5 Network

Network interface is shown as in Figure 7-36.

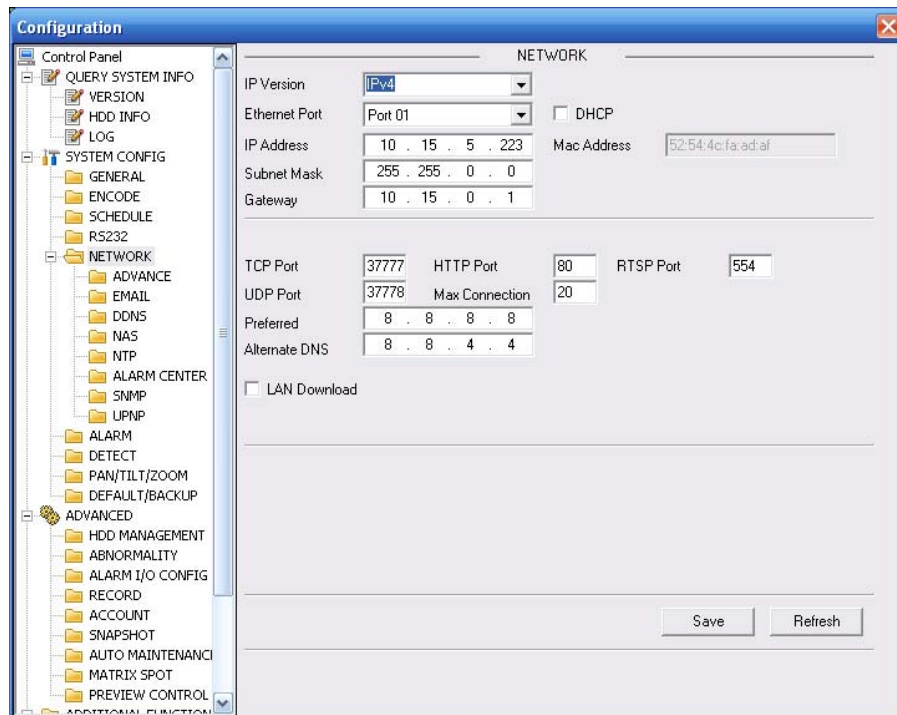

Figure 7-36

Please refer to the following sheet for detailed information.

Parameter	Function
IP Version	There are two options: IPv4 and IPv6. Right now, system supports these two IP address format and you can access via them.
MAC Address	The host in the LAN can get a unique MAC address. It is for you to access in the LAN. It is read-only.
IP Address	Here you can use up/down button (▲▼) or input the corresponding number to input IP address. Then you can set the corresponding subnet mask the default gateway.
Subnet Prefix	The input value ranges from 0 to 128. It is to mark a specified network MAC address. Usually it includes an organization of multiple-level.
Default Gateway	Here you can input the default gateway. Please note system needs to check the validity of all IPv6 addresses. The IP address and the default gateway shall be in the same IP section. That is to say, the specified length of the subnet prefix shall have the same string.
TCP Port	Default value is 37777.
HTTP Port	Default value is 554.
UDP Port	Default value is 37778.
Max Connection	Network user max amount. The value ranges from 0 to 20. 0 means there is no user can access current device.

- PPPoE

Please input the PPPoE user name and password you get from the IPS (internet service provider) and enable PPPoE function. Please save current setup and then reboot the device to get the setup activated.

Device connects to the internet via PPPoE after reboot. You can get the IP address in the WAN from the IP address column.

Note:

After PPPoE successful dial, you need to go to the device local end to get device current IP address and then use the client-end to access this IP address.

Advanced

The advanced interface is shown as in Figure 7-37.

- Multiple cast

Please refer to chapter 5.3.5.4 for detailed multiple cast setup information.

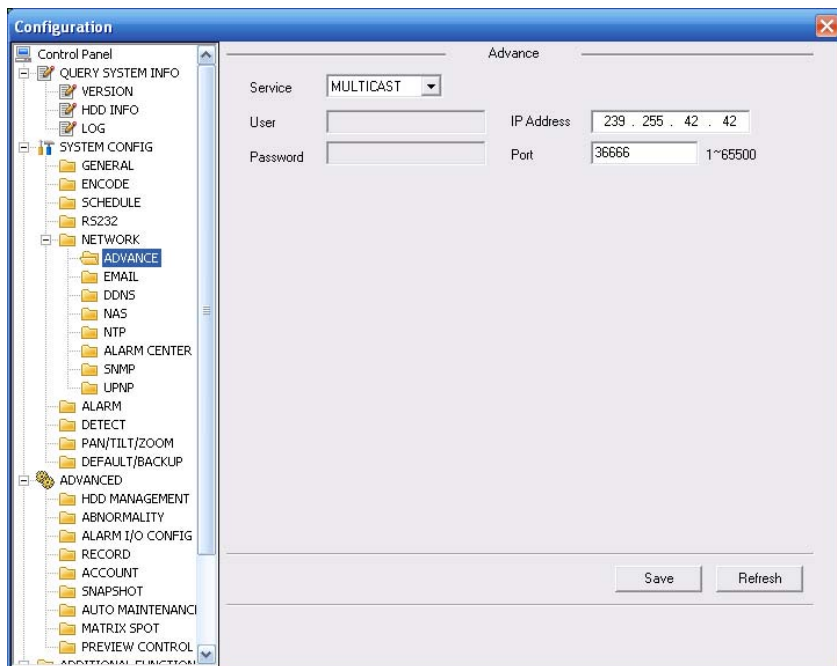

Figure 7-37

Email

The email interface is shown as in Figure 7-38.

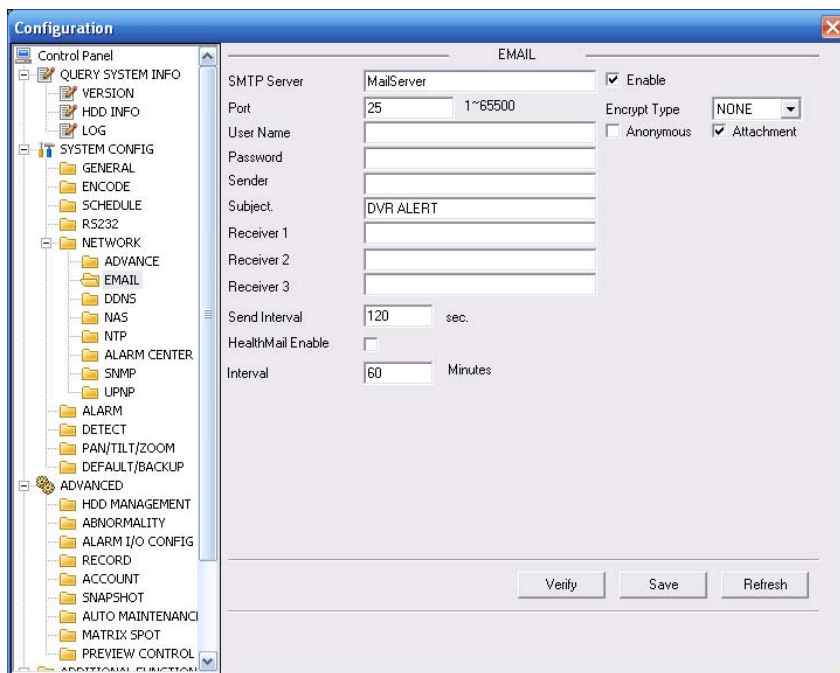

Figure 7-38

Please refer to the following sheet for detailed information.

Parameter	Function
SMTP Server	Input server address and then enable this function.
Port	Input port value here.
User Name	The sender email account user name.

Parameter	Function
Password	The sender email account password.
Sender	Sender email address.
Subject	Input email subject here. Max 32-digit.
Address	Input receiver email address here. Max input three addresses. Support SSL TLS encryption mailbox.
Health mail enable	Please check the box here to enable this function. This function allows the system to send out the test email to check the connection is OK or not.
Health mail interval	Please check the above box to enable this function and then set the corresponding interval. System can send out the email regularly as you set here.

DDNS

The DDNS interface is shown as in Figure 7-39.

Please make sure your DVR support this function.

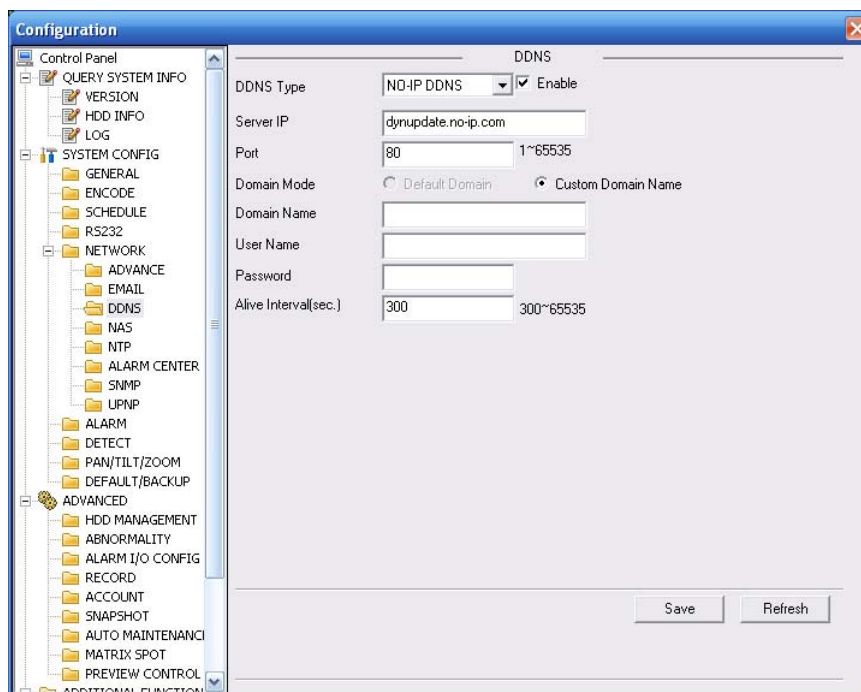

Figure 7-39

Please refer to the following sheet for detailed information.

Parameter	Function
Server Type	You can select DDNS protocol (Multiple-choice) from the dropdown list and then enable DDNS function.
Server IP	DDNS server IP address
Server Port	DDNS server port.
Domain Name	Your self-defined domain name.
User	The user name you input to log in the server.
Password	The password you input to log in the server.

Parameter	Function
Interval	<ul style="list-style-type: none"> • Device sends out alive signal to the server regularly. • You can set interval value between the device and DDNS server here.

Private DDNS and Client-end Introduction

1) Background Introduction

Device IP is not fixed if you use ADSL to login the network. The DDNS function allows you to access the DVR via the registered domain name. Besides the general DDNS, the private DDNS works with the device from the manufacturer so that it can add the extension function.

2) Function Introduction

The private DDNS client has the same function as other DDNS client end. It realizes the bonding of the domain name and the IP address. Right now, current DDNS server is for our own devices only. You need to refresh the bonding relationship of the domain and the IP regularly. There is no user name, password or the ID registration on the server. At the same time, each device has a default domain name (Generated by MAC address) for your option. You can also use customized valid domain name (has not registered.).

3) Operation

Before you use our private DDNS, you need to enable this service and set proper server address, port value and domain name.

- Server address: www.dahuaddns.com
- Port number: 80
- Domain name: There are two modes: Default domain name and customized domain name.

Except default domain name registration, you can also use customized domain name (You can input your self-defined domain name.) After successful registration, you can use domain name to login installed of the device IP.

- User name: It is optional. You can input your commonly used email address.

Important

- Do not register frequently. The interval between two registrations shall be more than 60 seconds. Too many registration requests may result in server attack.
- System may take back the domain name that is idle for one year. You can get a notification email before the cancel operation if your email address setup is OK.

NAS

NAS interface is shown as in Figure 7-40.

Please make sure your DVR support this function.

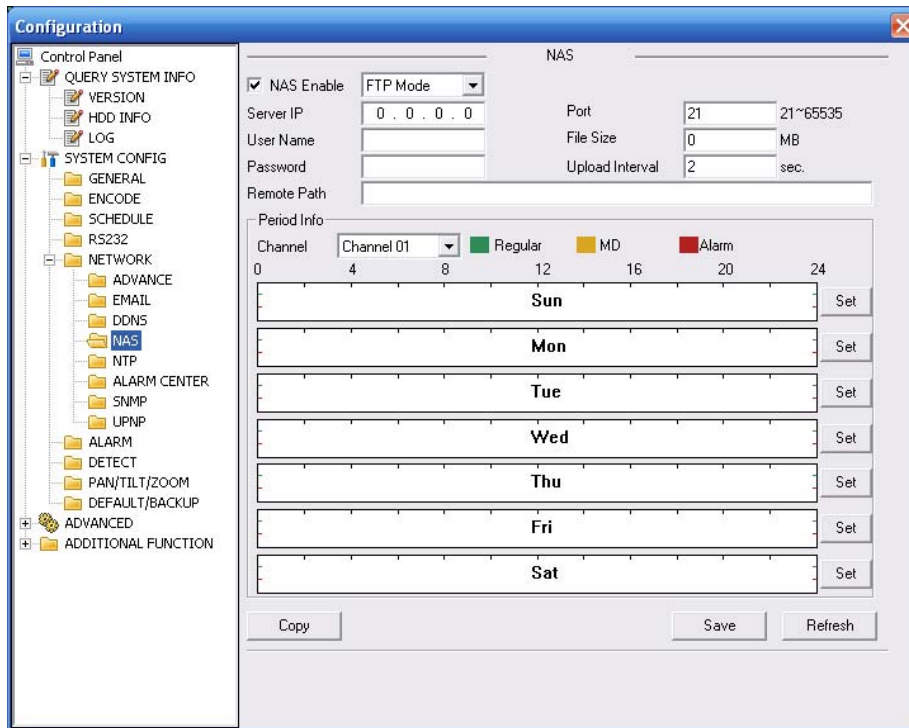

Figure 7-40

Please refer to the following sheet for detailed information.

Parameter	Function
NAS enable	Please select network storage protocol and then enable NAS function.
Server IP	Input remote storage server IP address.
Port	Input Remote storage server port number.
User Name	Log in user account.
File length	The file length you upload to the FTP. When setup is larger than the actual file length, system will upload the whole file. When setup here is smaller than the actual file length, system only uploads the set length and auto ignore the left section. When interval value is 0, system uploads all corresponding files.
Password	The password you need to log in the server.
Remote Path	Remote storage file path.
Save	You can click save button after you complete setup for one channel, or you can complete the whole setups and then click save button.
Refresh	Click this button to get device latest configuration information.

NTP

The NTP interface is shown as in Figure 7-41.

Here you can realize network time synchronization. Please enable current function and then input server IP, port number, time zone and update interval. Please note the SNTP supports TCP

transmission only and its port shall be 123. The update interval ranges from 1 to 65535. Default value is 10 minutes.

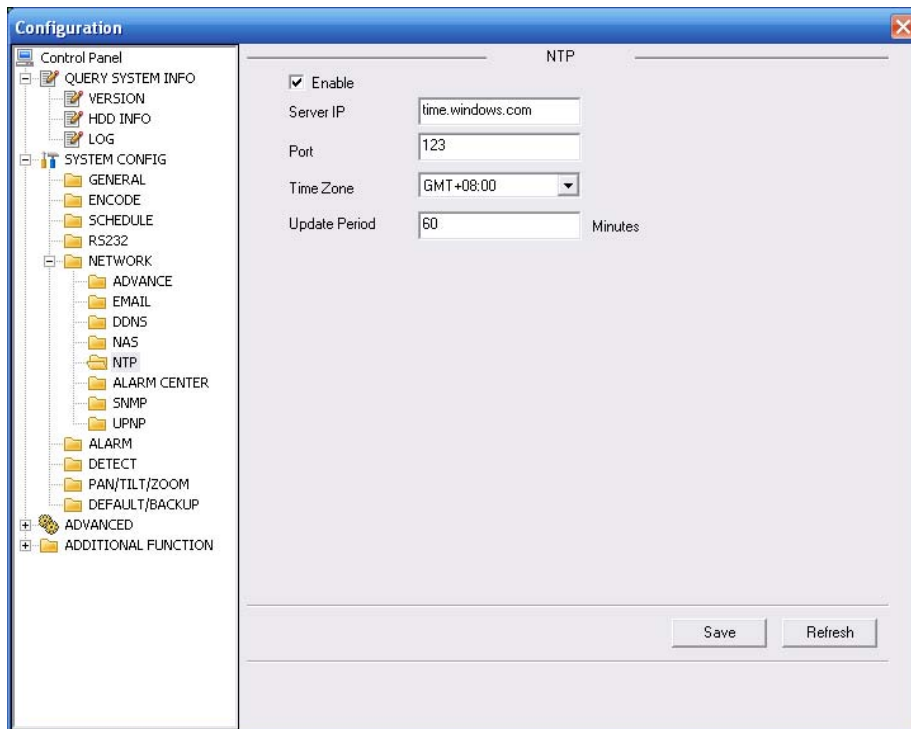

Figure 7-41

You can refer to the following sheet for time zone information.

City /Region Name	Time Zone
London	GMT+0
Berlin	GMT+1
Cairo	GMT+2
Moscow	GMT+3
New Deli	GMT+5
Bangkok	GMT+7
Beijing (Hong Kong)	GMT+8
Tokyo	GMT+9
Sydney	GMT+10
Hawaii	GMT-10
Alaska	GMT-9
Pacific Time(P.T)	GMT-8
American Mountain Time(M.T)	GMT-7
American Central Time(C.T)	GMT-6
American Eastern Time(E.T)	GMT-5
Atlantic Time	GMT-4
Brazil	GMT-3
Middle Atlantic Time	GMT-2

Alarm Centre

Alarm centre interface is shown as below. See Figure 7-42.

This interface is for you to develop. The alarm signal can be uploaded to the alarm centre when there is local alarm.

Please set the corresponding parameters such as server IP, port and etc.

The system can send out the data as the protocol defined to the client-end.

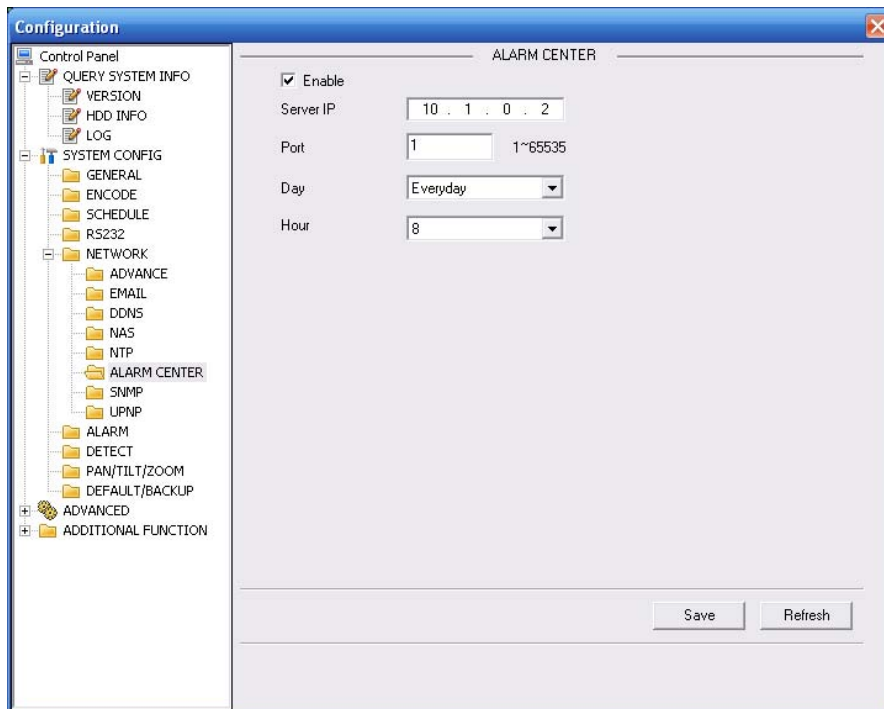

Figure 7-42

UPNP

Go to the UPnP interface, you can see an image is shown as in Figure 7-43. It allows you to establish the mapping relationship between the LAN and the public network. Here you can also add, modify or remove UPnP item.

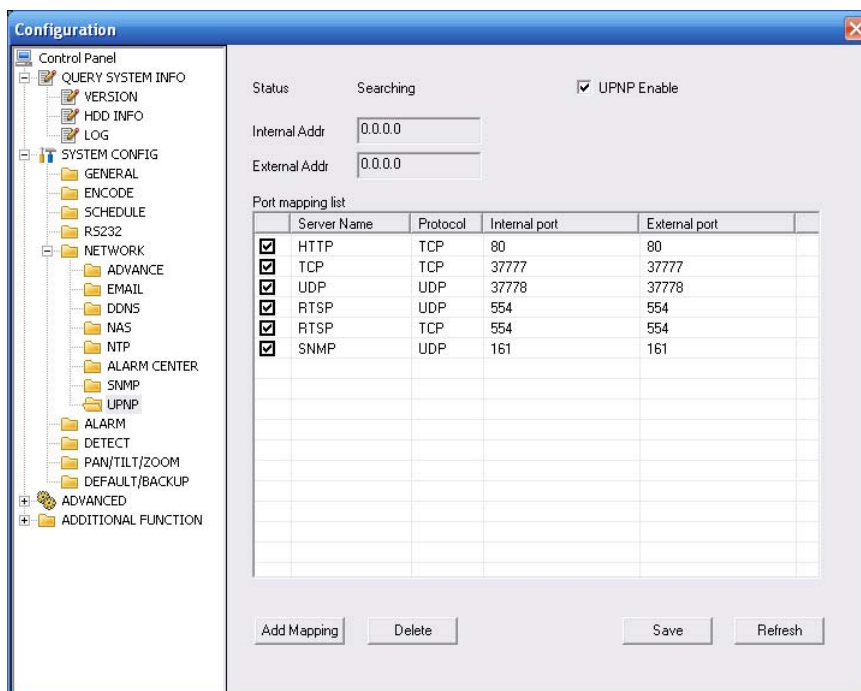

Figure 7-43 UPNP

SNMP

The SNMP interface is shown as in Figure 7-44.

SNMP is an abbreviation of Simple Network Management Protocol. It provides the basic network management frame of the network management system. The SNMP widely used in many environments. It is used in many network device, software and system. Please refer to chapter 5.3.5.12 SNMP for detailed information.

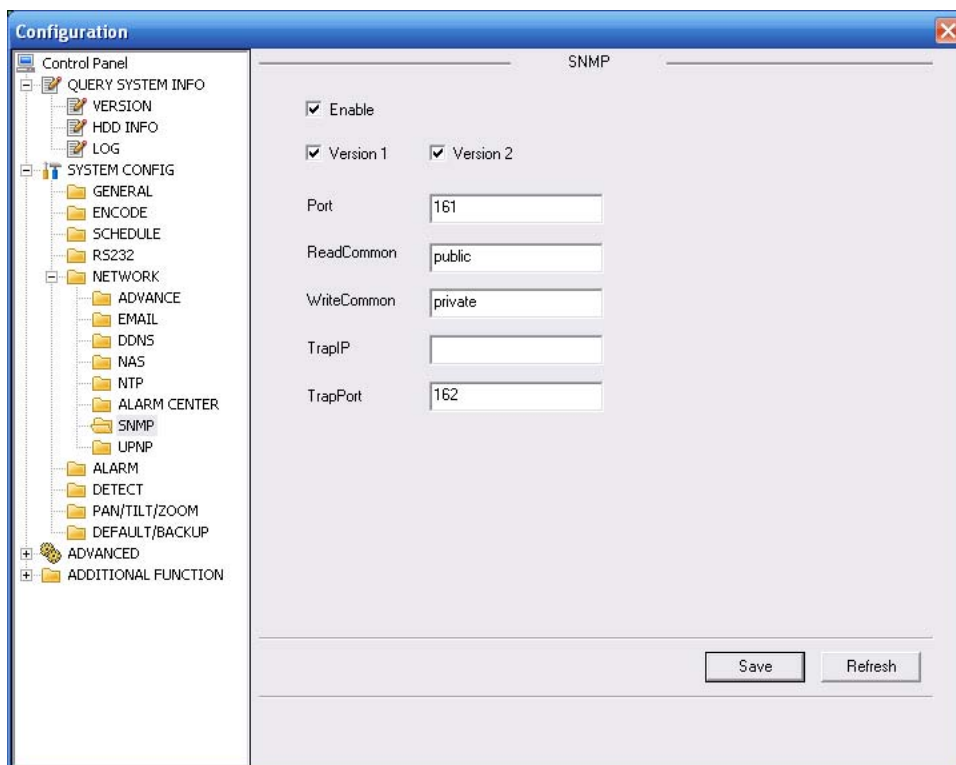

Figure 7-44 SNMP

7.5.2.6 Alarm

Alarm setup interface is shown as in Figure 7-45.

Please make sure you have connected the corresponding alarm output device such as the light, buzzer and etc.

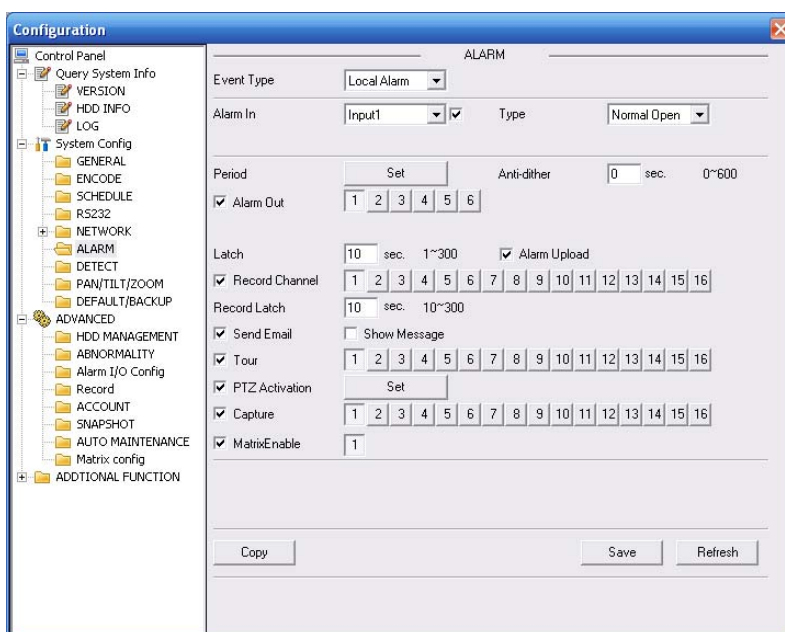

Figure 7-45

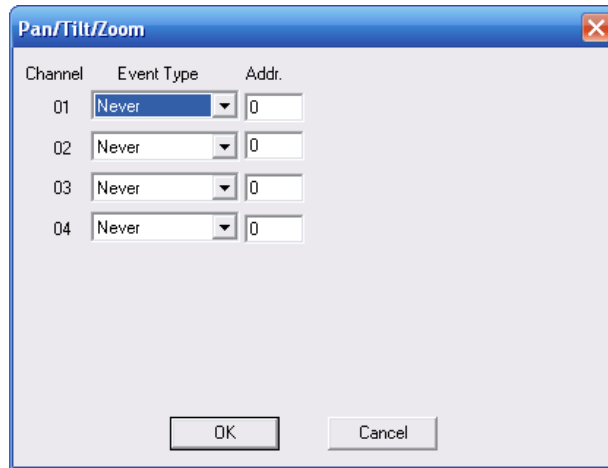

Figure 7-46

Please refer to the following sheet for detailed information.

Parameter	Function
Event Type	It includes local alarm/network alarm. Local alarm: Device detects alarm from input port. Network: Device detects alarm from network.
Alarm in	Select corresponding alarm channel.
Enable	You need to draw a circle here so that system can detect the alarm signal.
Type	There are two options: normal open and normal close. NO becomes activated in low voltage, NC becomes activated in high voltage.
Period	Alarm record function becomes activated in the specified periods. There are six periods in one day. Please draw a circle to enable corresponding period. Select date. If you do not select, current setup applies to today only. You can select all week column to apply to the whole week. Click OK button, system goes back to alarm setup interface, please click save button to exit.
Anti-dither	System only memorizes one event during the anti-dither period. The value ranges from 3 to 600s.
Normal Out	Enable alarm activation function. You need to select alarm output port so that system can activate corresponding alarm device when alarm occurred.
Alarm Latch	System can delay the alarm output for specified time after alarm ended. The value ranges from 1 second to 300 seconds.
Show message	System pops up the alarm messages in the monitor interface.
Buzzer	Once you check the box here, the buzzer beeps when an alarm occurred.
Alarm upload	System can upload the alarm signal to the centre (Including alarm centre).
Record Channel	System auto activates current channel to record once alarm occurs (working with alarm activation function). Please note current device shall be in auto record mode (Chapter 7.5.2.3 Schedule).
Record Latch	System can delay the record for specified time after alarm ended. The value ranges from 10s to 300s.
Email	Please draw a circle to enable email function. System can send out email to alert you when alarm occurs and ends.

Parameter	Function
Tour	Display the selected video in local monitor window. Tour interval and tour mode are set in DVR local menu (chapter 5.3.9 Display)
PTZ activation	Here you can set PTZ movement when alarm occurs. Such as go to preset x when there is an alarm. The PTZ configuration events include preset, tour, and pattern.
Capture	You need to input capture channel number so that system can backup snapshot file when alarm occurs.
Copy	It is a shortcut menu button. You can copy current channel setup to one or more (all) channels.
Save	You can click save button after you complete setup for one channel, or you can complete the whole setups and then click save button.
Refresh	Click this button to get device latest configuration information.

7.5.2.7 Detect

Analysis the video, system enable motion detection alarm when it detects the motion signal reached the specified sensitivity.

The detection interface is shown as in Figure 7-47.

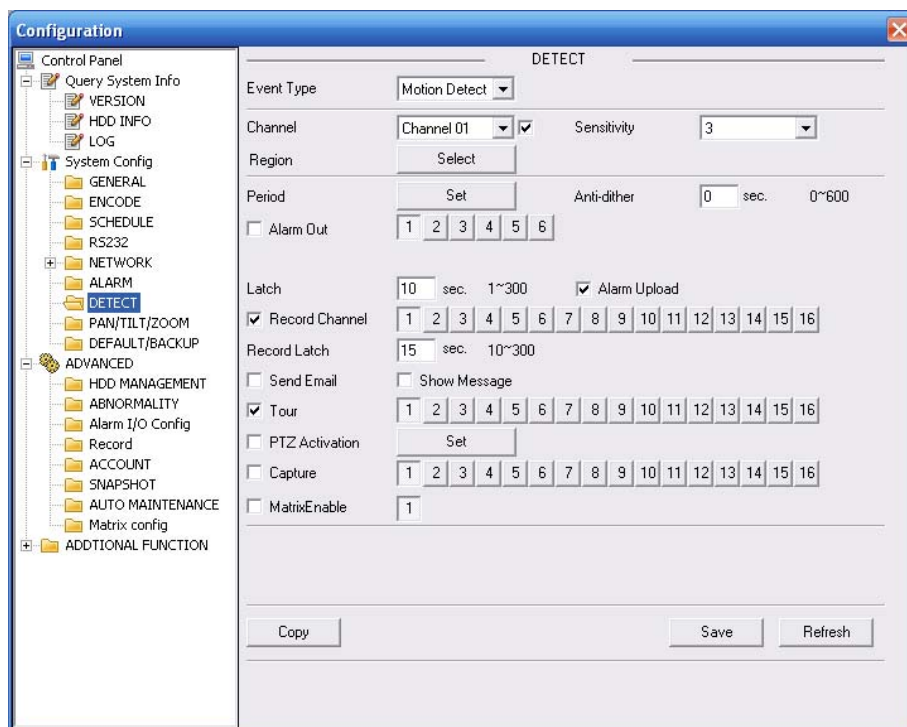

Figure 7-47

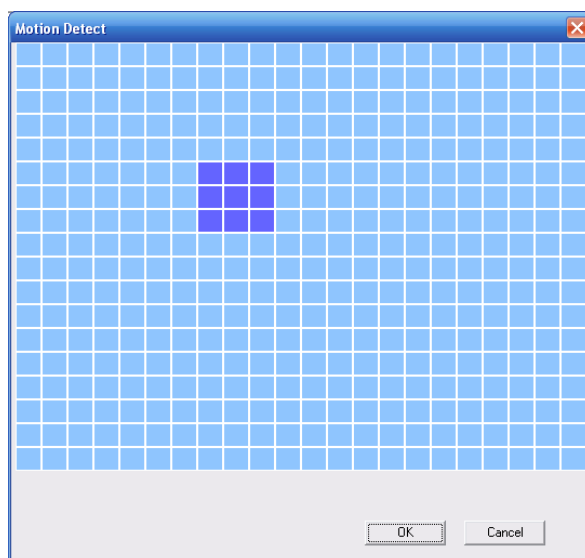

Figure 7-48

Please refer to the following sheet for detailed information.

Parameter	Function
Event Type	There are three types: Motion detection/video loss/Camera Masking.
Channel	Select channel name from the dropdown list.
Enable	You need to draw a circle to enable motion detection function.
Sensitivity	There are six levels. The sixth level has the highest sensitivity.
Region	<ul style="list-style-type: none"> • There are six levels. The sixth level has the highest sensitivity. • Region: If you select motion detection type, you can click this button to set motion detection zone. The interface is shown as in Figure 7-48. There are PAL 22X18/NTSC 22X15 zones. Right click mouse you can go to full-screen display mode. Do remember clicking OK button to save your motion detection zone setup.
Period	<ul style="list-style-type: none"> • Motion detection function becomes activated in the specified periods. • There are six periods in one day. Please draw a circle to enable corresponding period. • Select date. If you do not select, current setup applies to today only. You can select all week column to apply to the whole week. • Click OK button, system goes back to motion detection interface; please click save button to exit.
Anti-dither	System only memorizes one event during the anti-dither period. The value ranges from 3s to 600s.
Normal out	<ul style="list-style-type: none"> • There is 2-channel alarm output. • Corresponding to motion detection alarm output port(multiple choices) • Enable alarm activation function. You need to select alarm output port so that system can activate corresponding alarm device when alarm occurs.

Parameter	Function
Alarm latch	System can delay the alarm output for specified time after alarm end. The value ranges from 1s to 300s.
Show message	System pops up the alarm messages in the monitor interface.
Buzzer	Once you check the box here, the buzzer beeps when an alarm occurred.
Alarm upload	System can upload the alarm signal to the centre (Including alarm centre).
Record channel	System auto activates motion detection channel (multiple choices) to record once alarm occurs (working with motion detection function). Please note you need to go to Chapter 7.5.2.3 Schedule to set motion detection record period and go to chapter 7.5.3.3 Record to set current period as auto record.
Record latch	System can delay the record for specified time after alarm ended. The value ranges from 10s to 300s.
Email	If you enabled this function, System can send out email to alert you when alarm occurs and ends.
Tour	<ul style="list-style-type: none"> • Display the selected video in local monitor window. • Tour interval and tour mode are set in DVR local menu (chapter 5.3.9 Display)
PTZ Activation	<ul style="list-style-type: none"> • Here you can set PTZ movement when alarm occurs. Such as go to preset x when there is an alarm.
Capture	You need to input capture channel number so that system can backup motion detection snapshot file.
Matrix Enable	Please note this function is valid in motion detect mode. Check the box here to enable video matrix function. Right now system supports one-channel tour function. System takes “first come and first serve” principle to deal with the activated tour. System will process the new tour when a new alarm occurs after previous alarm ended. Otherwise it restores the previous output status before the alarm activation.
Copy	It is a shortcut menu button. You can copy current channel setup to one or more (all) channels.
Save	You can click save button after you complete setup for one channel, or you can complete the whole setups and then click save button.
Refresh	Click this button to get device latest configuration information.

7.5.2.8 PTZ

PTZ interface is shown as in Figure 7-49.

Please note, before operation please make sure you have set speed dome address. And DVR and speed dome connection is OK.

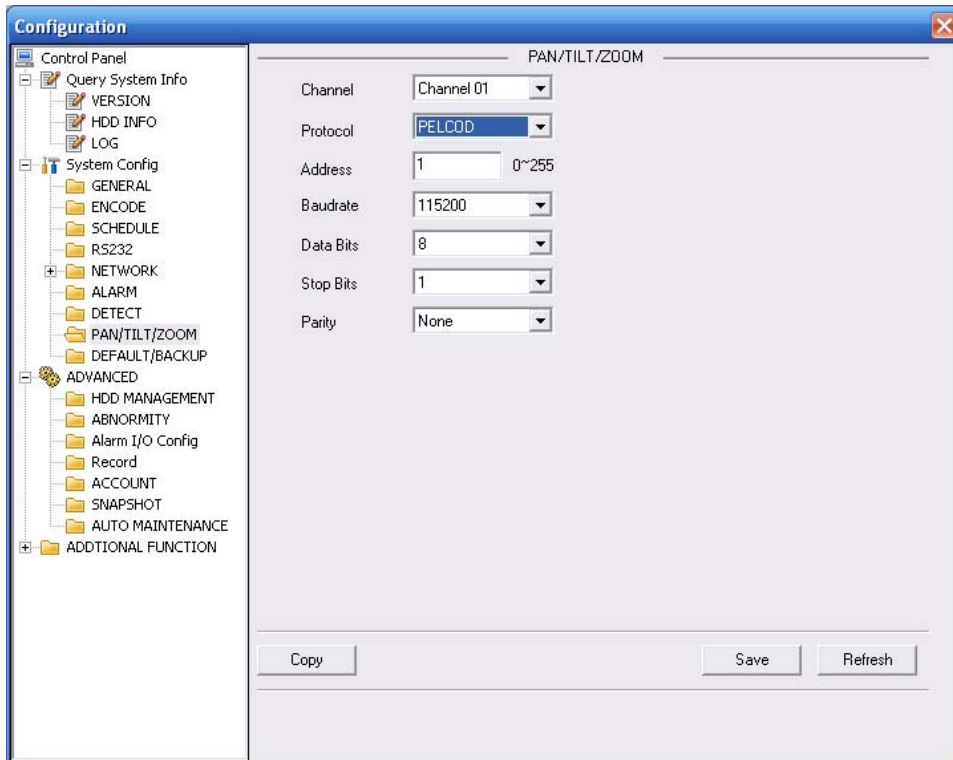

Figure 7-49

Please refer to the following sheet for detailed information.

Parameter	Function
Channel	You can select monitor channel from the dropdown list. .
Protocol	Select the corresponding dome protocol.(such as PELCOD)
Address	Set corresponding dome address. Default value is 1. Please note your setup here shall comply with your dome address; otherwise you can not control the speed dome.
Baud Rate	Select the dome baud rate. Default setup is 9600.
Data Bit	Default setup is 8. Please set according to the speed dome dial switch setup.
Stop bit	Default setup is 1. Please set according to the speed dome dial switch setup.
Parity	Default setup is none. Please set according to the speed dome dial switch setup.
Save	You can click save button after you complete setup for one channel, or you can complete the whole setups and then click save button.
Refresh	Click this button to get device latest configuration information.

7.5.2.9 Default & Backup

Default: Restore factory default setup. You can select corresponding items.

Backup: Export current configuration to local PC or import configuration from current PC.

Please refer to Figure 7-50.

Please note system can not restore some information such as network IP address.

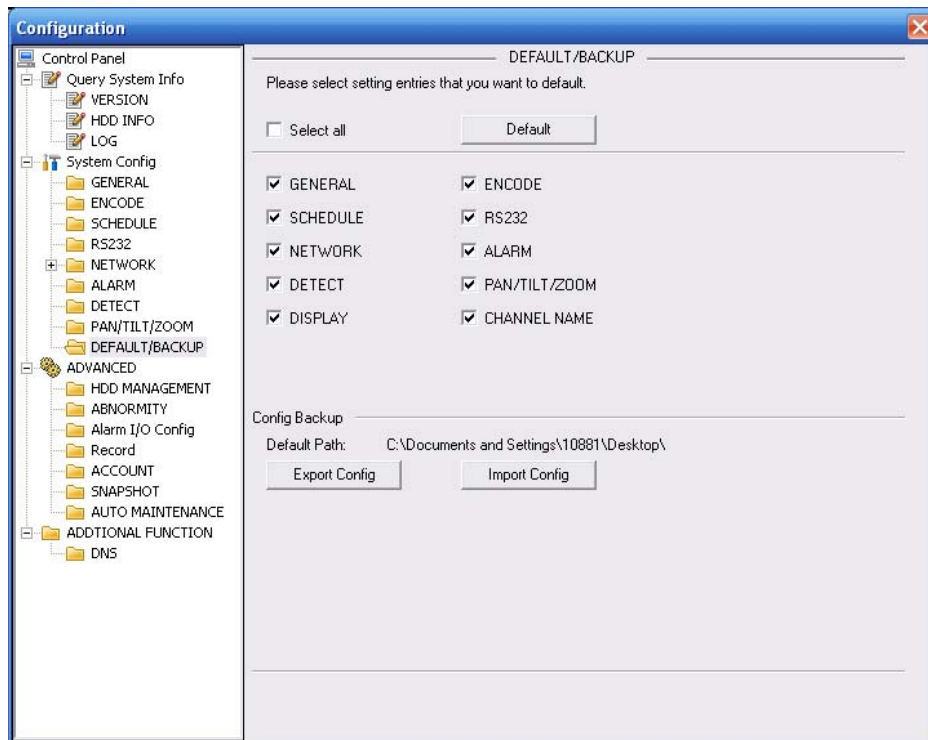

Figure 7-50

Please refer to the following sheet for detailed information.

Parameter	Function
Select All	Restore factory default setup.
Export Configuration	Export system configuration to local PC.
Import Configuration	Import configuration from PC to the system.

7.5.3 Advanced

7.5.3.1 HDD Management

HDD management includes net storage management and local storage management.

Please note, if you want to use local storage function, your storage device need to support current function.

Please select the storage device first and then you can see the items on your right become valid.

You can check the corresponding item here. See Figure 7-51.

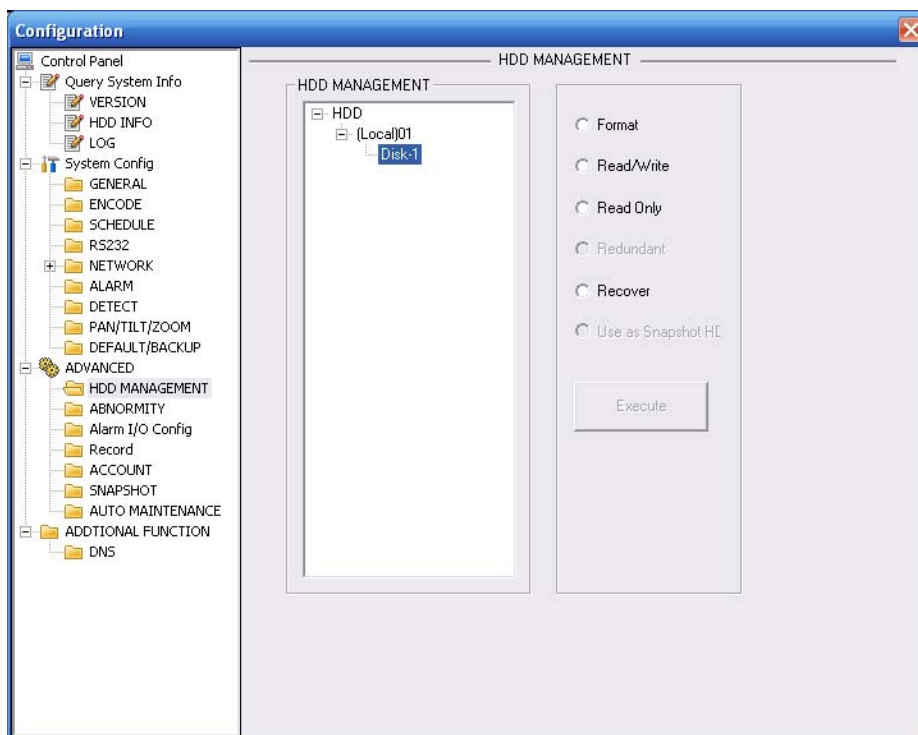

Figure 7-51

Please refer to the following sheet for detailed information.

Parameter	Function
Format	Clear data in the disk.
Read/write	Set current disk as read/write
Read only	Set current disk as read.
Redundant	Set current disk as redundant disk.
Recover	Recover data after error occurs.
Use as snapshot	Set current disk as snapshot disk.

Please note system needs to reboot to activate current setup.

7.5.3.2 Alarm I/O

Here you can search alarm output status. See Figure 7-52.

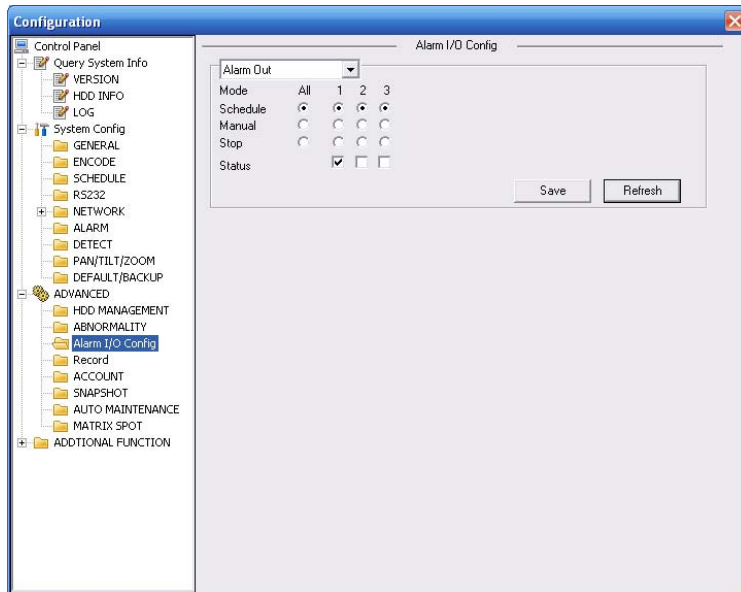

Figure 7-52

Important

The alarm output port should not be connected to high power load directly (It shall be less than 1A) to avoid high current which may result in relay damage. Please use the co contactor to realize the connection between the alarm output port and the load.

Please refer to the following sheet for detailed information.

Parameter	Function
Alarm output	There are three output channels (Multiple choices). Please note the displayed alarm output channel amount here may vary due to the different series.
Activate	Enable/disable alarm output device. After the Web activated the alarm, you need to cancel the channel and then click the activation button to cancel the alarm, or you need to cancel the alarm in the pop-up dialogue box in local-end.
Refresh	Search alarm output status.

7.5.3.3 Record

Record control interface is shown as in Figure 7-53.

The bit stream type includes main stream and extra stream.

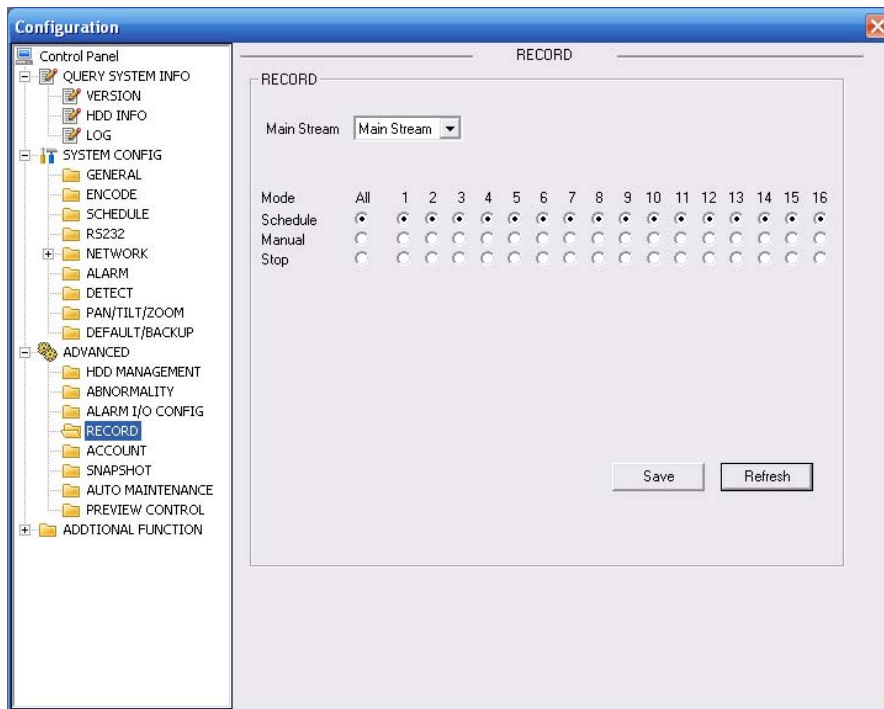

Figure 7-53

Please refer to the following sheet for detailed information.

Parameter	Function
Auto	System enables auto record function as you set in record schedule setup.
Manual	Enable corresponding channel to record no matter what period applied in the record setup.
Stop	Stop current channel record no matter what period applied in the record setup.

Operation here is the same to chapter 4.3 Manual Record. Please refer to chapter 4.3 for detailed information.

7.5.3.4 Account

Here you can add, remove user or modify password. See Figure 7-54.

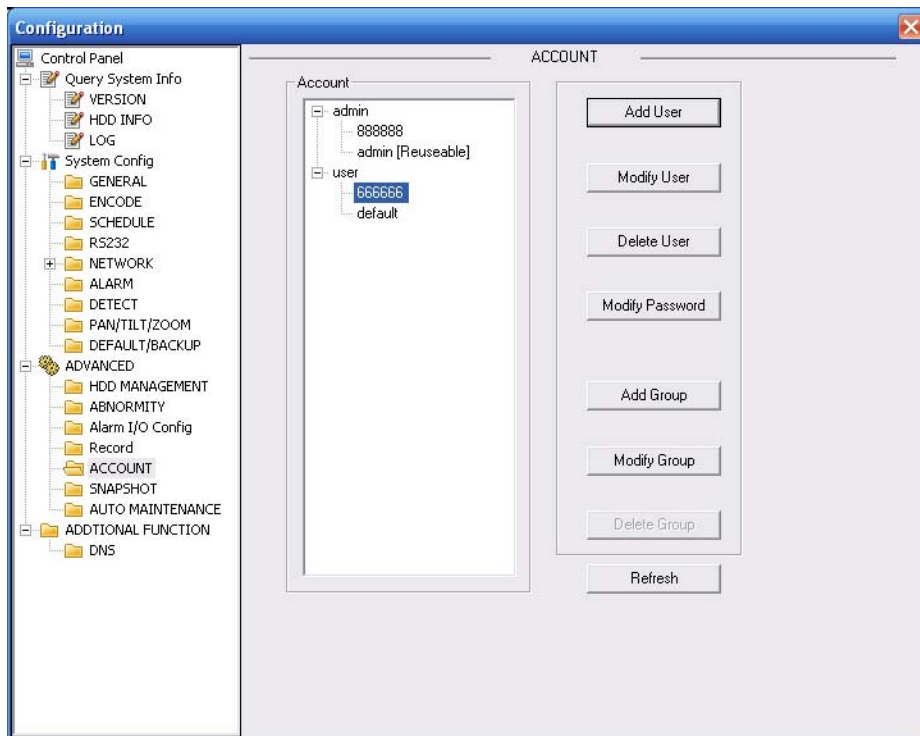

Figure 7-54

7.5.3.5 Auto Maintenance

Here you can select auto reboot and auto delete old files interval from the dropdown list. See Figure 7-55.

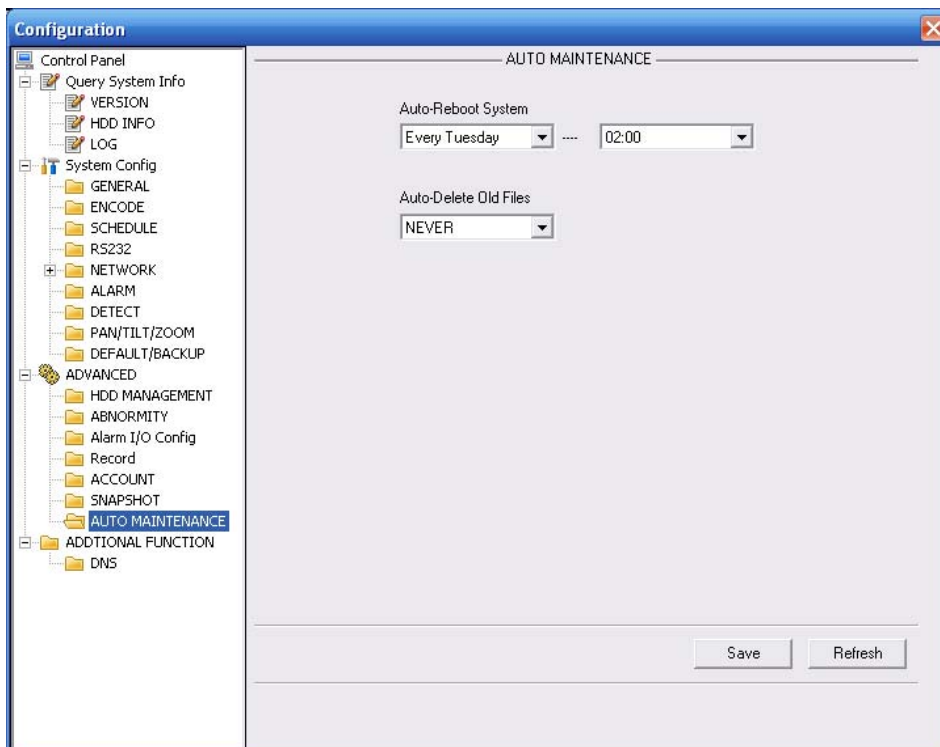

Figure 7-55

7.5.3.6 Snapshot

Snapshot interface is shown as in Figure 7-56.

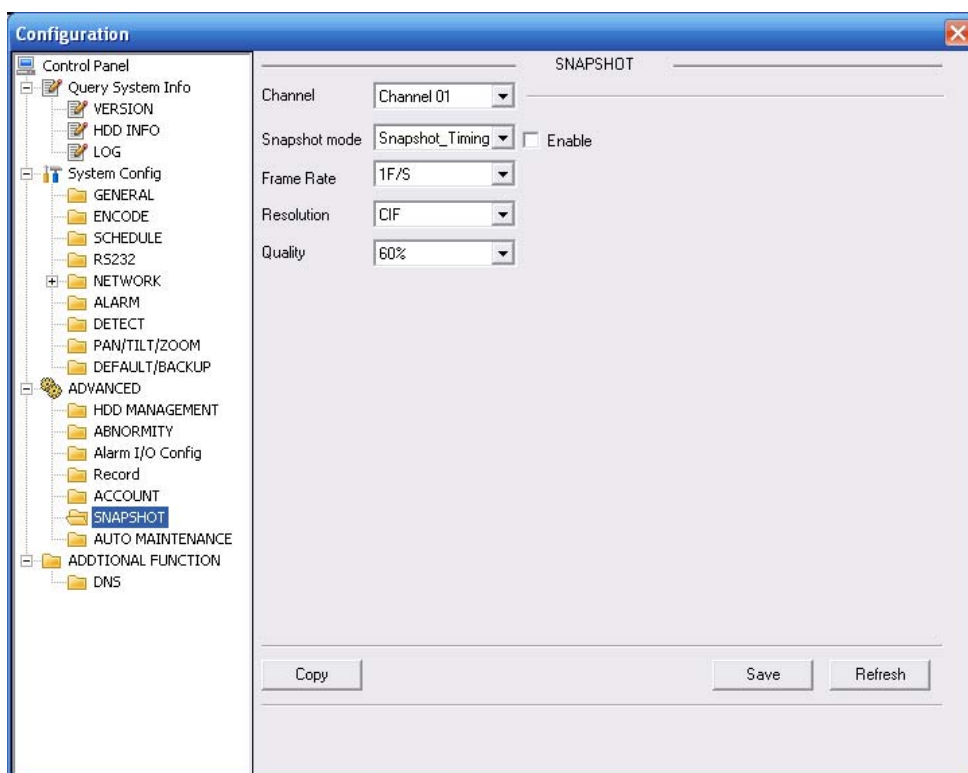

Figure 7-56

Please refer to the following sheet for detailed information.

Parameter	Function
Channel	It is the monitor channel.
Snapshot mode	There are two modes: Timing and activation.
Frame rate	You can select from the dropdown list. The value ranges from 1f/s to 7f/s.
Resolution	You can select from the dropdown list. The 1-Channel 1 and the 9-channel support D1/HD1/2CIF/CIF/QCIF. Channel 2 to channel 8, channel 10 to channel 16 supports CIF/QCIF. Note: <ul style="list-style-type: none"> ● HD-SDI series product supports 1080P,720P,D1,HD1、2CIF,CIF, QCIF. ● 960H series supports 960H/D1/HD1/2CIF/CIF/QCIF.
Quality	You can select from the dropdown list. Here is for you to set video quality. There are six options: 10%, 30%, 50%, 60%, 80%, 100%. 100% is the best quality.

7.5.3.7 Abnormity

The abnormity interface is shown as below. See Figure 7-57.

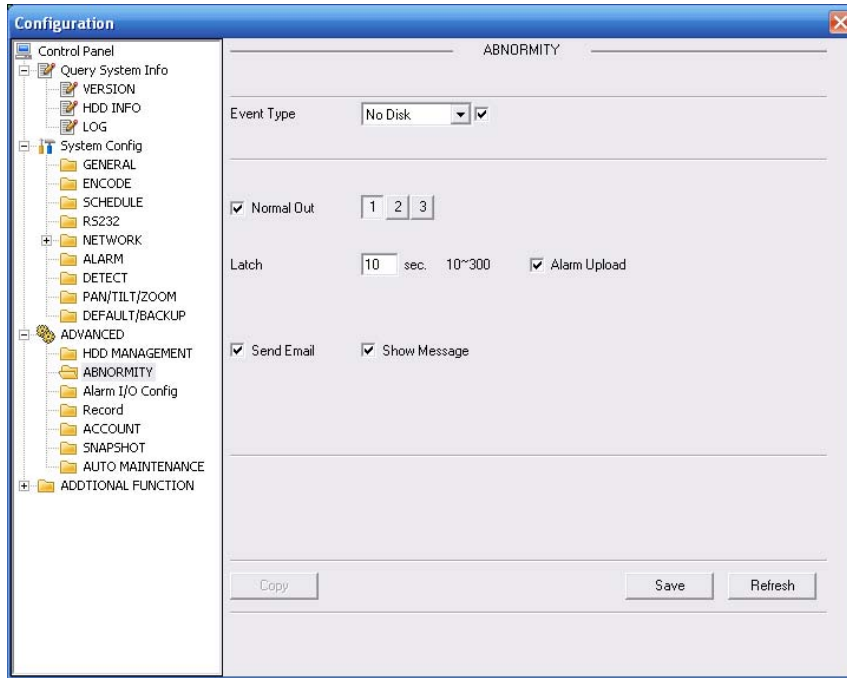

Figure 7-57

Please refer to the following sheet for detailed information.

Parameter	Function
Event Type	<ul style="list-style-type: none"> The abnormal events include: disk error, no disk, disconnection, IP conflict, MAC conflict and etc You need to draw a circle to enable this function.
Normal Out	The corresponding alarm activation output channel when alarm occurs, There are six channels.
Latch	The alarm output can delay for the specified time after alarm stops. Then system disables alarm and corresponding activation output. The value ranges from 10s to 300s.
Send email	If you enable this function, system can send out email to alarm the specified user.
Alarm upload	System can upload the alarm signal to the network (includes the alarm centre.)
Show message	System pops up the alarm messages in the monitor interface.
Buzzer	Once you check the box here, the buzzer beeps when an alarm occurred.

7.5.3.8 Matrix Spot

Here you can set four channel and corresponding interval. You can set 1/4/9/16-window spot tour. See Figure 7-58.

Please note HD-SDI series does not support this function and 960H series only supports single-window spot tour.

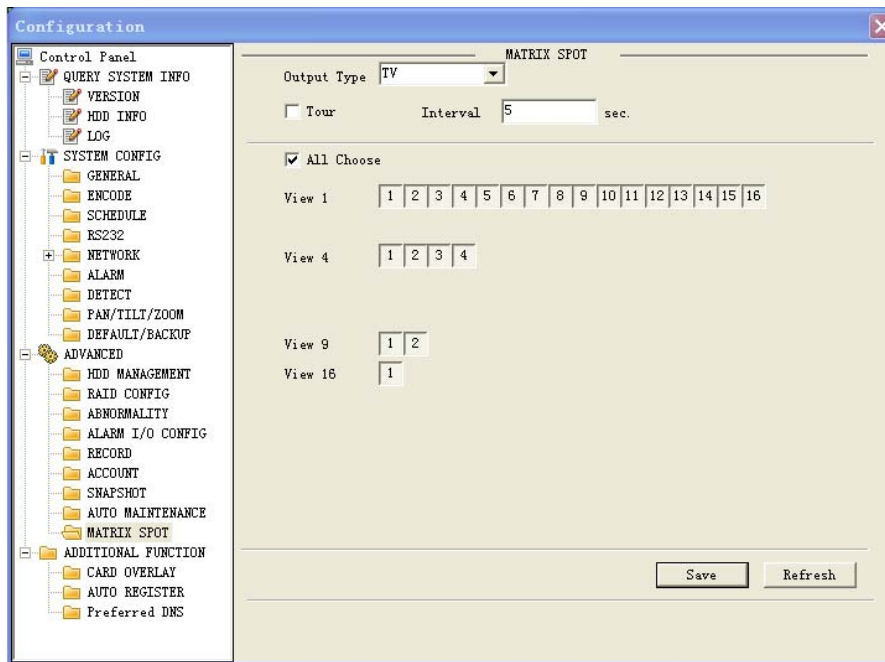

Figure 7-58

7.5.3.9 Preview Control

Here you can set preview mode: 1/4/8/9/16-window. The preview channel ranges from channel 1 to channel 16. See Figure 7-59.

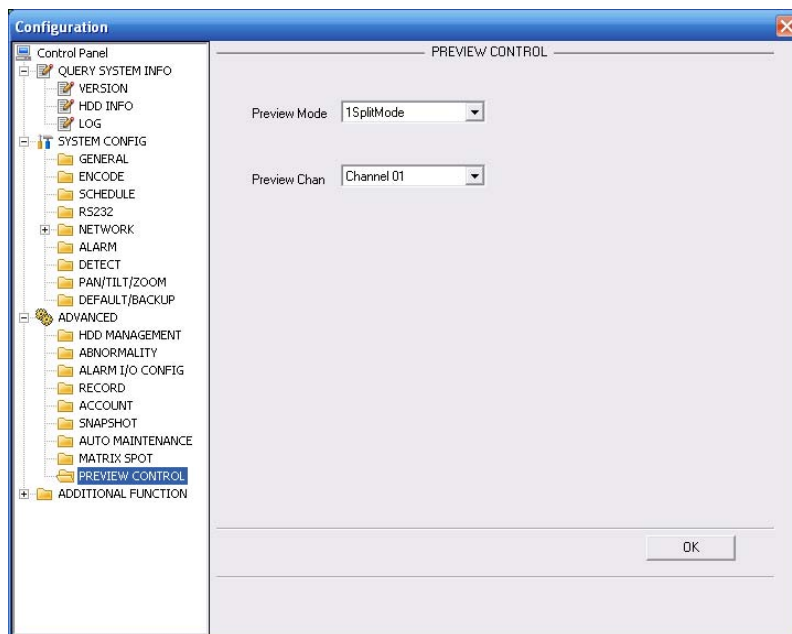

Figure 7-59

7.5.4 Additional Function

7.5.4.1 Preferred DNS

Here you can set server or local operator DNS address. See Figure 7-60.

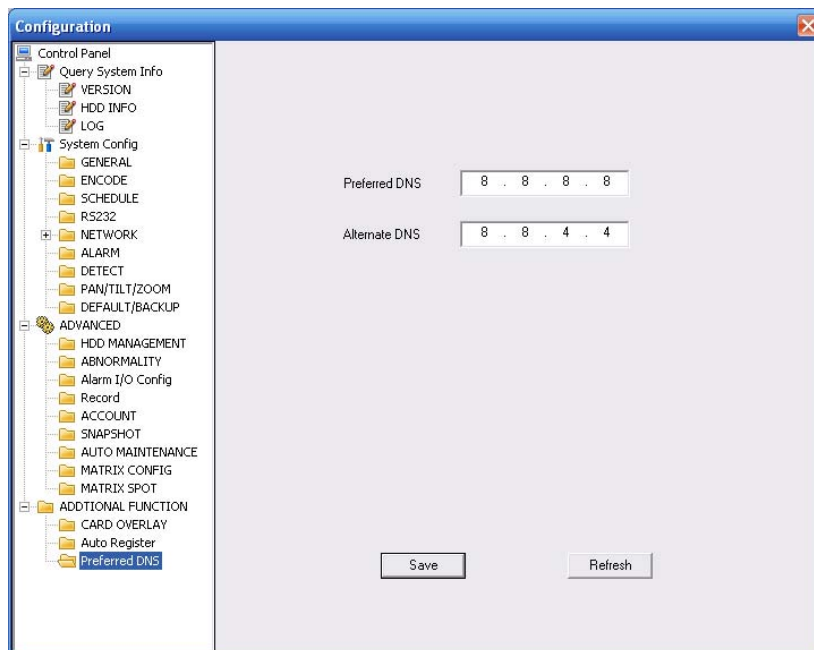

Figure 7-60

7.5.4.2 Card Overlay

Tit is the same with the card overlay function (chapter 5.5.9). It is mainly for financial areas to Sniffer, information parse and character overlay. The ATM/POS interface is shown as in Figure 7-61.

Source IP refers to host IP address that sends out information (usually it is the device host connected to the DVR.)

Destination IP refers to other systems that receive information.

There are total four groups IP. The record channel applies to one group (optional) only.

Six frame ID groups verification can guarantee information validity and legal.

The start position, length and data can be set according to your protocol and data packet. There are total four fields.

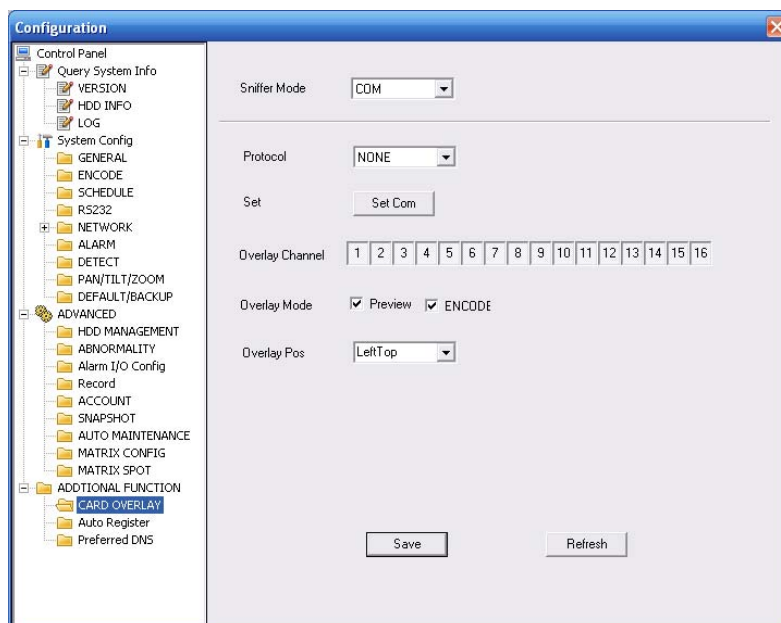

Figure 7-61

7.5.4.3 Auto Register

Auto register interface is shown as below. See Figure 7-62.

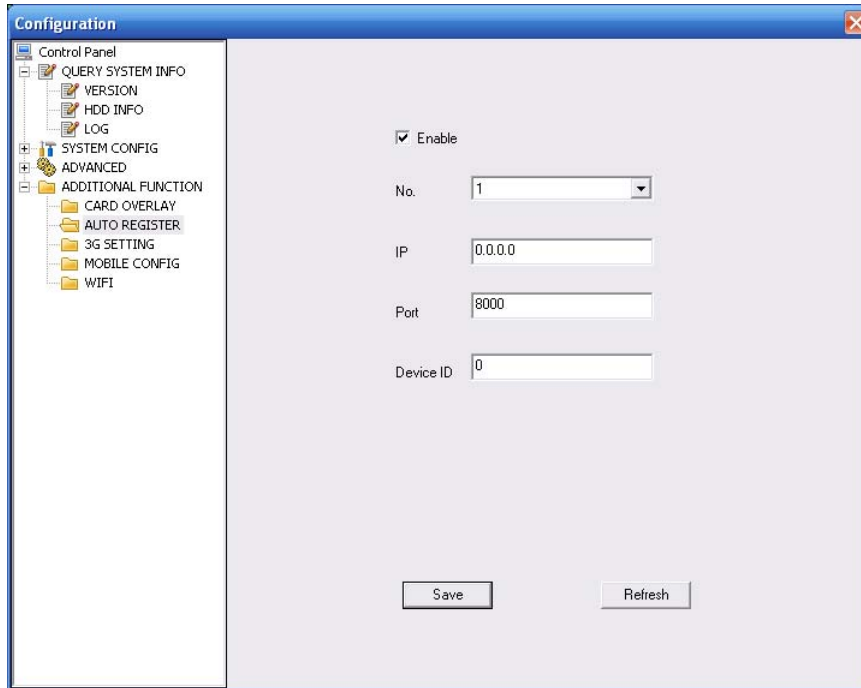

Figure 7-62 Auto Register

Please refer to the following sheet for detailed information.

Parameter	Function
Enable	Enable auto register function.
No.	Device management server number.
IP	Device management server IP address.
Port	Server port number.
Device ID	Device ID in the device management server.

7.5.4.4 Mobile Config

The mobile setup interface is shown as in Figure 7-63.

Here you can activate or disconnect device 3G connection such as telephone or mobile phone, or the alarm activated message No.

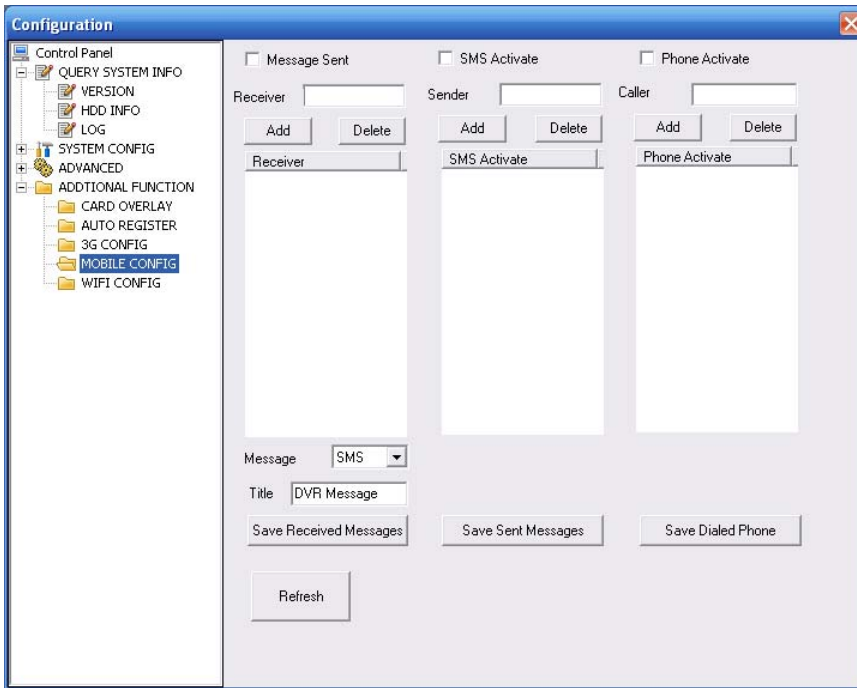

Figure 7-63 Mobile Setup

7.5.4.5 WIFI Config

The WIFI interface is shown as in Figure 7-64.

Here you can view WIFI connection status. System displays as no connection if there is no connection. You can view connection status and IP address if there is a connection. See Figure 7-65.

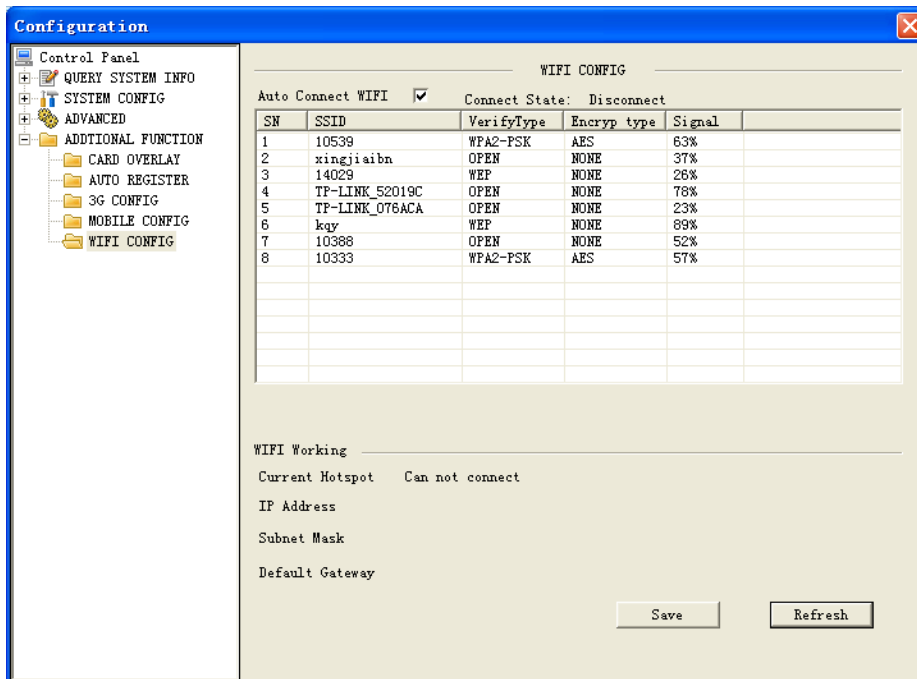

Figure 7-64 WIFI Setup

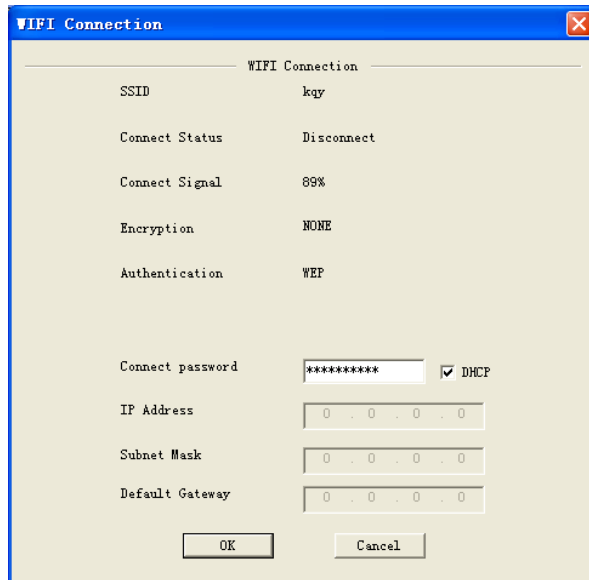

Figure 7-65

Please refer to the following sheet for detailed information.

Parameter	Function
Refresh	Search hotspot again and system can automatically add the information such as password (If there is any record of the hotspot.)
WIFI working information	Here you can view current connection status. You can view connection status and IP address if there is a connection. Otherwise system shown as there is no hotspot connection.

7.6 Search

Click search button, you can see an interface is shown as in Figure 7-60.

Please set record type, record date, window display mode and channel name.

You can click the date on the right pane to select the date. The green highlighted date is system current date and the blue highlighted date means it has record files.



Figure 7-66

Then please click search button, you can see the corresponding files in the list. See Figure 7-61.

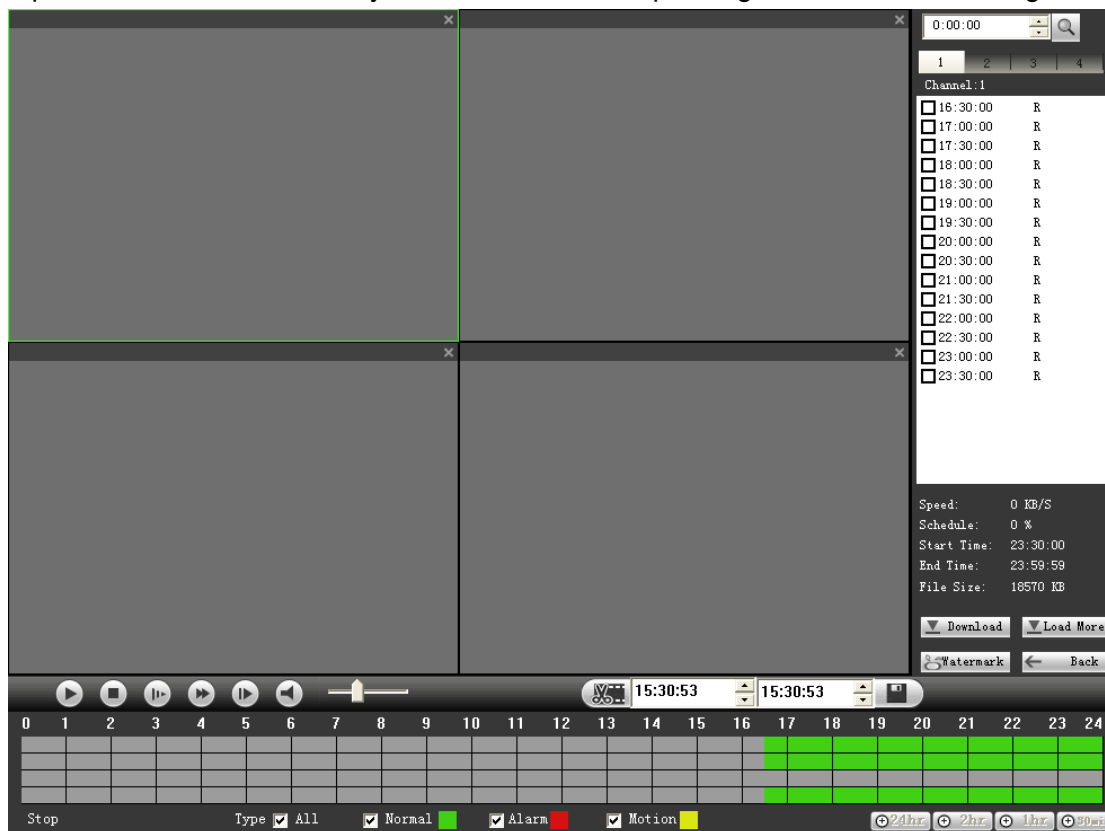

Figure 7-67

Select the file(s) you want to download and then click download button, system pops up a dialogue box shown as in Figure 7-62, then you can specify file name and path to download the file(s) to your local pc.

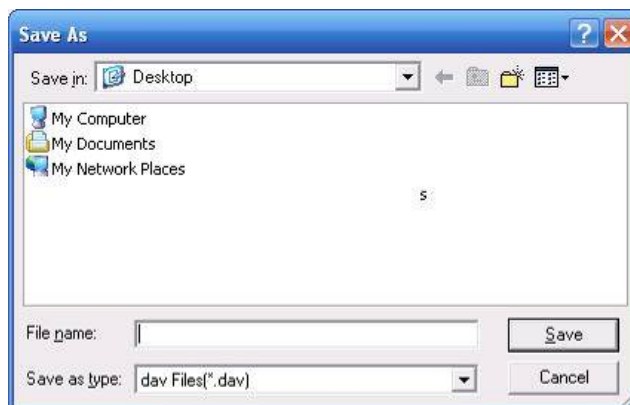

Figure 7-68

Load more

It is for you to search record or picture. You can select record channel, record type and record time to download. See Figure 7-69.

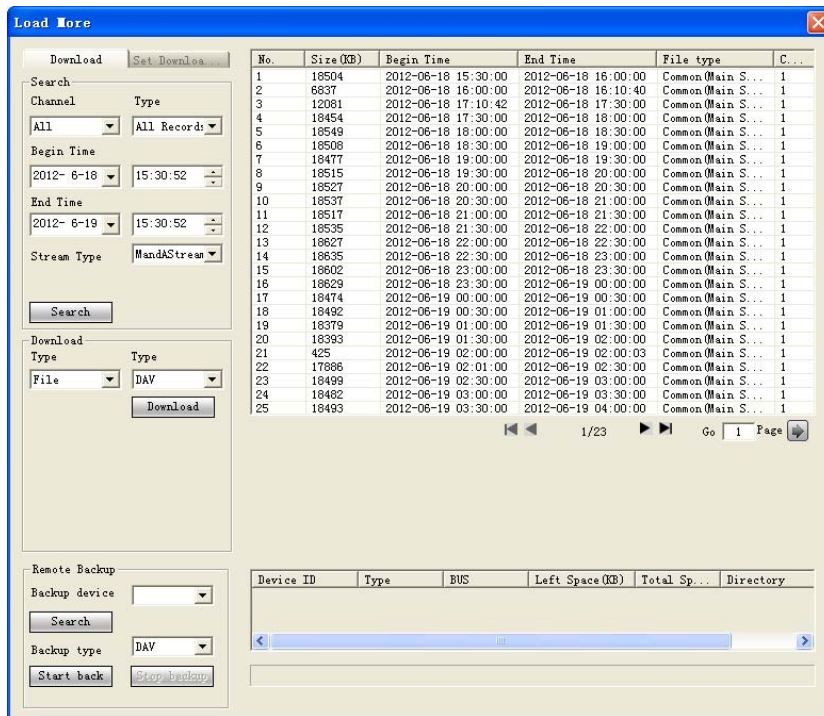

Figure 7-69

Remote backup

In Figure 7-69, there is a remote back pane at the left bottom of the pane. It allows you to backup the record or picture to your local USB storage media via the Web remotely. Click the search button; you can view the available storage device. See Figure 7-69. Please select from the dropdown list and then begin the backup. Please refer to chapter 7.3.4 to set device download path.

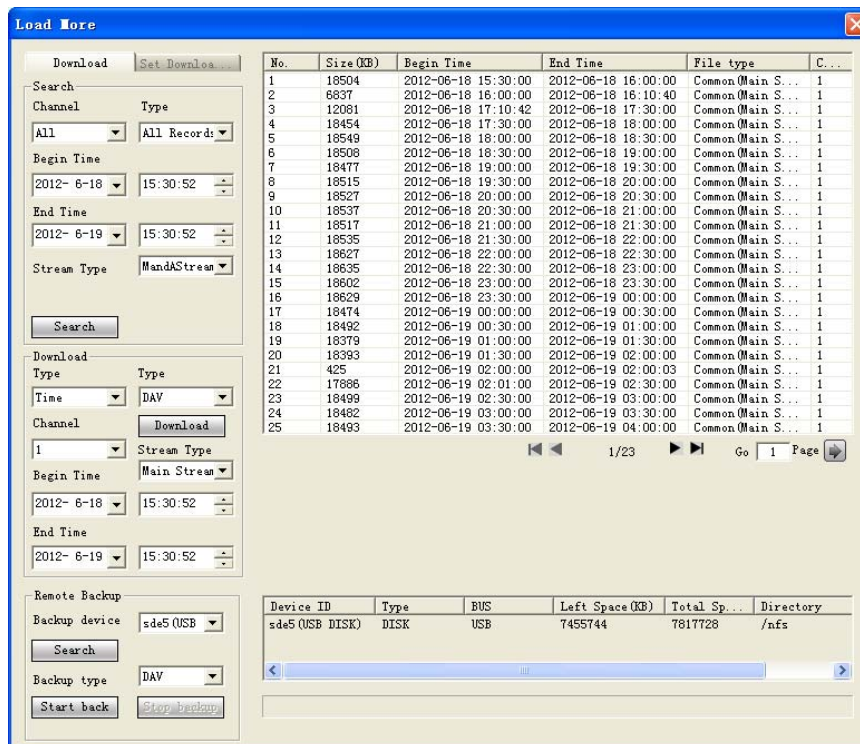

Figure 7-70

Now you can see system begins download and the download button becomes stop button. You can click it to terminate current operation.

At the bottom of the interface, there is a process bar for your reference.

7.7 Alarm

Click alarm function, you can see an interface is shown as in Figure 7-64.

Here you can set device alarm type and alarm sound setup.

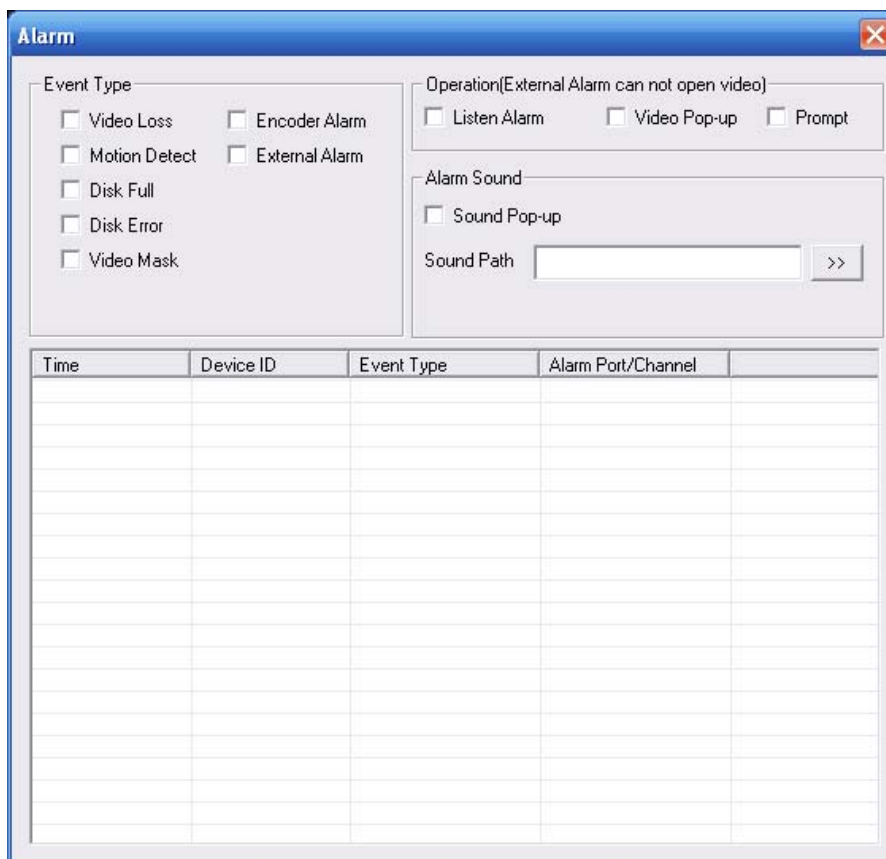

Figure 7-71

Please refer to the following sheet for detailed information.

Please make sure current device can upload the alarm.

Type	Parameter	Function
Alarm Type	Video loss	System alarms when video loss occurs.
	Motion detection	System alarms when motion detection alarm occurs,
	Disk full	System alarms when disk is full.
	Disk error	System alarms when disk error occurs.
	Camera masking	System alarms when camera is viciously masking.
	Encode alarm	System alarms when peripheral device alarms.
	External alarm	Alarm input device sends out alarm.
Operation	Listen alarm	System notifies web when alarm occurs (you select from the above event type), and then web can notify user.

Type	Parameter	Function
	Video	When alarm occurs, system auto enables video monitor. This function only applies to video detection alarm (motion detection, video loss and camera masking).
	Prompt	Automatically pops up alarm dialogue box.
	Sound pop up	System sends out alarm sound when alarm occurs. You can specify as you wish.
	Path	Here you can specify alarm sound file.

7.8 About

Click about button, you can view current web client information. See Figure 7-65.

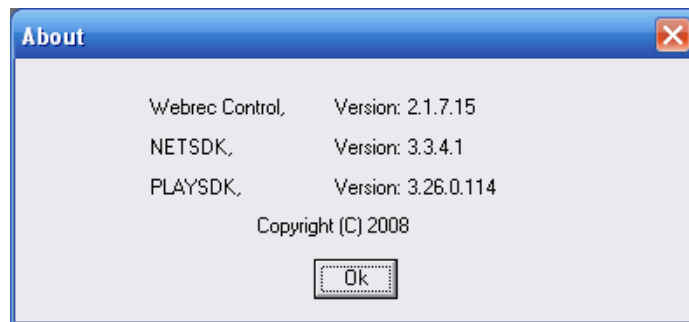

Figure 7-72

7.9 Log out

Click log out button, system goes back to log in interface. See Figure 7-66.

You need to input user name and password to login again.

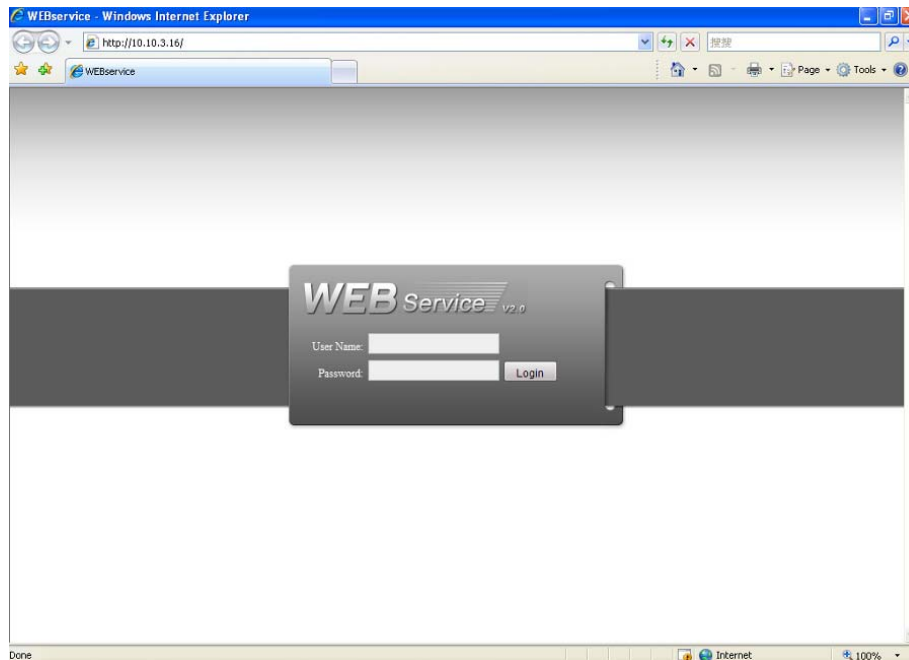

Figure 7-73

7.10 Un-install Web Control

You can use web un-install tool “uninstall web.bat” to un-install web control.

Please note, before you un-installation, please close all web pages, otherwise the un-installation might result in error.

8 Professional Surveillance System

Besides Web, you can use our Professional Surveillance Software (PSS) to login the device. For detailed information, please refer to *PSS user's manual*.

9 FAQ

1. DVR can not boot up properly.

There are following possibilities:

- Input power is not correct.
- Power connection is not correct.
- Power switch button is damaged.
- Program upgrade is wrong.
- HDD malfunction or something wrong with HDD ribbon.
- Seagate DB35.1, DB35.2, SV35 or Maxtor 17-g has compatibility problem. Please upgrade to the latest version to solve this problem.
- Front panel error.
- Main board is damaged.

2. DVR often automatically shuts down or stops running.

There are following possibilities:

- Input voltage is not stable or it is too low.
- HDD malfunction or something wrong with the ribbon.
- Button power is not enough.
- Front video signal is not stable.
- Working environment is too harsh, too much dust.
- Hardware malfunction.

3. System can not detect hard disk.

There are following possibilities:

- HDD is broken.
- HDD ribbon is damaged.
- HDD cable connection is loose.
- Main board SATA port is broken.

4. There is no video output whether it is one-channel, multiple-channel or all-channel output.

There are following possibilities:

- Program is not compatible. Please upgrade to the latest version.
- Brightness is 0. Please restore factory default setup.
- There is no video input signal or it is too weak.
- Check privacy mask setup or your screen saver.
- DVR hardware malfunctions.

5. Real-time video color is distorted.

There are following possibilities:

- When using BNC output, NTSC and PAL setup is not correct. The real-time video becomes black and white.
- DVR and monitor resistance is not compatible.
- Video transmission is too long or degrading is too huge.

- DVR color or brightness setup is not correct.

6. Can not search local records.

There are following possibilities:

- HDD ribbon is damaged.
- HDD is broken.
- Upgraded program is not compatible.
- The recorded file has been overwritten.
- Record function has been disabled.

7. Video is distorted when searching local records.

There are following possibilities:

- Video quality setup is too low.
- Program read error, bit data is too small. There is mosaic in the full screen. Please restart the DVR to solve this problem.
- HDD data ribbon error.
- HDD malfunction.
- DVR hardware malfunctions.

8. There is no audio when monitor.

There are following possibilities:

- It is not a power picker.
- It is not a power acoustics.
- Audio cable is damaged.
- DVR hardware malfunctions.

9. There is audio when monitor but there is no audio when system playback.

There are following possibilities:

- Setup is not correct. Please enable audio function
- Corresponding channel has no video input. Playback is not continuous when the screen is blue.

10. Time display is not correct.

There are following possibilities:

- Setup is not correct
- Battery contact is not correct or voltage is too low.
- Crystal is broken.

11. DVR can not control PTZ.

There are following possibilities:

- Front panel PTZ error
- PTZ decoder setup, connection or installation is not correct.
- Cable connection is not correct.
- PTZ setup is not correct.
- PTZ decoder and DVR protocol is not compatible.

- PTZ decoder and DVR address is not compatible.
- When there are several decoders, please add 120 Ohm between the PTZ decoder A/B cables furthest end to delete the reverberation or impedance matching. Otherwise the PTZ control is not stable.
- The distance is too far.

12. Motion detection function does not work.

There are following possibilities:

- Period setup is not correct.
- Motion detection zone setup is not correct.
- Sensitivity is too low.
- For some versions, there is hardware limit.

13. Can not log in client-end or web.

There are following possibilities:

- For Windows 98 or Windows ME user, please update your system to Windows 2000 sp4. Or you can install client-end software of lower version. Please note right now, our DVR is not compatible with Windows VISTA control.
- ActiveX control has been disabled.
- No dx8.1 or higher. Please upgrade display card driver.
- Network connection error.
- Network setup error.
- Password or user name is invalid.
- Client-end is not compatible with DVR program.

14. There is only mosaic no video when preview or playback video file remotely.

There are following possibilities:

- Network fluency is not good.
- Client-end resources are limit.
- There is multiple-cast group setup in DVR. This mode can result in mosaic. Usually we do not recommend this mode.
- There is privacy mask or channel protection setup.
- Current user has no right to monitor.
- DVR local video output quality is not good.

15. Network connection is not stable.

There are following possibilities:

- Network is not stable.
- IP address conflict.
- MAC address conflict.
- PC or DVR network card is not good.

16. Burn error /USB back error.

There are following possibilities:

- Burner and DVR are in the same data cable.

- System uses too much CPU resources. Please stop record first and then begin backup.
- Data amount exceeds backup device capacity. It may result in burner error.
- Backup device is not compatible.
- Backup device is damaged.

17. Keyboard can not control DVR.

There are following possibilities:

- DVR serial port setup is not correct
- Address is not correct
- When there are several switchers, power supply is not enough.
- Transmission distance is too far.

18. Alarm signal can not been disarmed.

There are following possibilities:

- Alarm setup is not correct.
- Alarm output has been open manually.
- Input device error or connection is not correct.
- Some program versions may have this problem. Please upgrade your system.

19. Alarm function is null.

There are following possibilities:

- Alarm setup is not correct.
- Alarm cable connection is not correct.
- Alarm input signal is not correct.
- There are two loops connect to one alarm device.

21. Record storage period is not enough.

There are following possibilities:

- Camera quality is too low. Lens is dirty. Camera is installed against the light. Camera aperture setup is not correct.
- HDD capacity is not enough.
- HDD is damaged.

22. Can not playback the downloaded file.

There are following possibilities:

- There is no media player.
- No DXB8.1 or higher graphic acceleration software.
- There is no DivX503Bundle.exe control when you play the file transformed to AVI via media player.
- No DivX503Bundle.exe or ffdshow-2004 1012 .exe in Windows XP OS.

23. Forgot local menu operation password or network password

Please contact your local service engineer or our sales person for help. We can guide you to solve this problem.

24. For the HD-SDI 1080P 1.5U and 2U series product, system loses frames when record local file or the playback is not smooth.

There are following possibilities:

- Close extra stream record function.
- Close snapshot function.
- Reduce monitor channel amount of the WEB.
- Close FTP upload function.

Daily Maintenance

- Please use the brush to clean the board, socket connector and the chassis regularly.
- The device shall be soundly earthed in case there is audio/video disturbance. Keep the device away from the static voltage or induced voltage.
- Please unplug the power cable before you remove the audio/video signal cable, RS232 or RS485 cable.
- Do not connect the TV to the local video output port (VOUT).It may result in video output circuit.
- Always shut down the device properly. Please use the shutdown function in the menu, or you can press the power button in the rear pane for at least three seconds to shut down the device. Otherwise it may result in HDD malfunction.
- Please make sure the device is away from the direct sunlight or other heating sources. Please keep the sound ventilation.
- Please check and maintain the device regularly.

Appendix A HDD Capacity Calculation

Calculate total capacity needed by each DVR according to video recording (video recording type and video file storage time).

Step 1: According to Formula (1) to calculate storage capacity q_i that is the capacity of each channel needed for each hour, unit Mbyte.

$$q_i = d_i \div 8 \times 3600 \div 1024 \quad (1)$$

In the formula: d_i means the bit rate, unit Kbit/s

Step 2: After video time requirement is confirmed, according to Formula (2) to calculate the storage capacity m_i , which is storage of each channel needed unit Mbyte.

$$m_i = q_i \times h_i \times D_i \quad (2)$$

In the formula:

h_i means the recording time for each day (hour)

D_i means number of days for which the video shall be kept

Step 3: According to Formula (3) to calculate total capacity (accumulation) q_T that is needed for all channels in the DVR during **scheduled video recording**.

$$q_T = \sum_{i=1}^c m_i \quad (3)$$

In the formula: c means total number of channels in one DVR

Step 4: According to Formula (4) to calculate total capacity (accumulation) q_T that is needed for all channels in DVR during **alarm video recording (including motion detection)**.

$$q_T = \sum_{i=1}^c m_i \times a\% \quad (4)$$

In the formula: $a\%$ means alarm occurrence rate

Appendix B Compatible Backup Device List

Compatible USB drive list

NOTE: Please upgrade the DVR firmware to latest version to ensure the accuracy of the table below. If you use the USB drive, please confirm the format FAT or FAT32.

Manufacturer	Model	Capacity
Sandisk	Cruzer Micro	512M
Sandisk	Cruzer Micro	1G
Sandisk	Cruzer Micro	2G
Sandisk	Cruzer Freedom	256M
Sandisk	Cruzer Freedom	512M
Sandisk	Cruzer Freedom	1G
Sandisk	Cruzer Freedom	2G
Kingston	DataTraveler II	1G
Kingston	DataTraveler II	2G
Kingston	DataTraveler	1G
Kingston	DataTraveler	2G
Maxell	USB Flash Stick	128M
Maxell	USB Flash Stick	256M
Maxell	USB Flash Stick	512M
Maxell	USB Flash Stick	1G
Maxell	USB Flash Stick	2G
Kingax	Super Stick	128M
Kingax	Super Stick	256M
Kingax	Super Stick	512M
Kingax	Super Stick	1G
Kingax	Super Stick	2G
Netac	U210	128M
Netac	U210	256M
Netac	U210	512M
Netac	U210	1G
Netac	U210	2G
Netac	U208	4G
Teclast	Ti Cool	128M
Teclast	Ti Cool	256M
Teclast	Ti Cool	512M
Teclast	Ti Cool	1G
SanDisk	cruzer mirco	2G
SanDisk	cruzer mirco	8G
SanDisk	Ti Cool	2G
SanDisk	Hongjiao	4G
Lexar	Lexar	256MB
Kingston	Data Traveler	1G
Kingston	Data Traveler	16GB
Kingston	Data Traveler	32GB
Aigo	L8315	16GB
Sandisk	250	16GB
Kingston	Data Traveler Locker+	32GB
Netac	U228	8GB

Compatible SD Card List

Please refer to the following sheet for compatible SD card brand.

Brand	Standard	Capacity	Card type
Transcend	SDHC6	16GB	SD
Kingston	SDHC4	4GB	SD
Kingston	SD	2GB	SD
Kingston	SD	1GB	SD
Sandisk	SDHC2	8GB	Micro-SD
Sandisk	SD	1GB	Micro-SD

Compatible Portable HDD List

Please refer to the following sheet for compatible portable HDD brand.

Brand	Model	Capacity
YDStar	YDstar HDD box	40G
Netac	Netac	80G
Iomega	Iomega RPHD-CG" RNAJ50U287	250GB
WD Elements	WCAVY1205901	1.5TB
Newsmy	Liangjian	320GB
WD Elements	WDBAAR5000ABK-00	500GB
WD Elements	WDBAAU0015HBK-00	1.5TB
Seagate	FreeAgent Go(ST905003F)	500GB
Aigo	H8169	500GB

Compatible USB DVD Burner List

NOTE: Please upgrade the DVR firmware to latest version to ensure the accuracy of the table below. And you can use the USB cable with the model recommended to set USB burner.

Manufacturer	Model
Sony	DRX-S70U
Benq	TW200D

Compatible SATA DVD Burner List

NOTE: Please upgrade the DVR firmware to latest version to ensure the accuracy of the table below.

Manufacturer	Model
Pioneer	DVR-215CHG
Panasonic	SW-9588-C
Sumsung	TS-H653
Sony	DRU-V200S
Sony	DRU-845S
Samsung	TS-H653
Pioneer	DVR-217CHG
LG	GH22NS30

Compatible SATA HDD List

NOTE: Please upgrade the DVR firmware to latest version to ensure the accuracy of the table below. And SATA HDD should be used for the DVR with SATA port.

Manufacturer	Series	Model	Capacity	Port Mode
Seagate	Barracuda.10	ST3750640AS	750G	SATA

Seagate	Barracuda.10	ST3500630AS	500G	SATA
Seagate	Barracuda.10	ST3400620AS	400G	SATA
Seagate	Barracuda.10	ST3320620AS	320G	SATA
Seagate	Barracuda.10	ST3250620AS	250G	SATA
Seagate	Barracuda.10	ST3250820AS	250G	SATA
Seagate	Barracuda.10	ST3160815AS	160G	SATA
Seagate	Barracuda.10	ST380815AS	80G	SATA
Seagate	Barracuda.9	ST3160811AS2	160G	SATA
Seagate	Barracuda.9	ST3120811AS2	120G	SATA
Seagate	Barracuda.9	ST380811AS2	80	SATA
Seagate	Barracuda.9	ST380211AS2	80G	SATA
Seagate	Barracuda.11	ST3750330AS	750G	SATA
Seagate	Barracuda.11	ST3500320AS	500G	SATA
Seagate	Barracuda 7200.11	ST31500341AS	1.5T	SATA
Seagate	Pipeline HD.2	ST3320311CS	320G	SATA
Seagate	SV35.2	ST3160815SV	160G	SATA
Seagate	SV35.2	ST3250310SV	250G	SATA
Seagate	SV35.2	ST3320620SV	320G	SATA
Seagate	SV35.2	ST3500320SV	500G	SATA
Seagate	SV35.2	ST3750640SV	750G	SATA
Seagate	SV35.3	ST31000340SV	1T	SATA
Maxtor	DiamondMax 20	STM3320820AS	320G	SATA
Maxtor	DiamondMax 20	STM3250820AS	250G	SATA
Maxtor	DiamondMax 21	STM3160211AS	160G	SATA
Maxtor	DiamondMax 21	STM380211AS	80G	SATA
Maxtor	DiamondMax 21	STM340211AS	40G	SATA
Western Digital	Cariar SE	WD3200JD	320G	SATA
Western Digital	Cariar SE	WD3000JD	300G	SATA
Western Digital	Cariar SE	WD2500JS	250G	SATA
Western Digital	Cariar SE	WD2000JD	200G	SATA
Western Digital	Cariar SE	WD1600JD	160G	SATA
Western Digital	Cariar SE	WD1600JS	160G	SATA
Western Digital	Cariar SE	WD1200JS	120G	SATA
Western Digital	Cariar SE	WD800JD	80G	SATA
Western Digital	Cariar	WD1600AABS2	160G	SATA
Western Digital	Cariar	WD800BD	80G	SATA
Western Digital	Cariar SE16	WD7500KS2	750G	SATA
Western Digital	Cariar SE16	WD5000KS2	500G	SATA
Western Digital	Cariar SE16	WD4000KD2	400G	SATA
Western Digital	Cariar SE16	WD3200KS2	320G	SATA
Western Digital	Cariar SE16	WD2500KS2	250G	SATA
Western Digital	RE series	WD5000ABYS	500G	SATA
Western Digital	Caviar Green series	WD20EADS	2T	SATA

Samsung	/	HA101UJ/CE	1T	SATA
---------	---	------------	----	------

APPENDIX C Compatible CD/DVD Device List

NOTE: Please upgrade the DVR firmware to latest version to ensure the accuracy of the table below. And you can use the USB cable with the model recommended to set USB burner.

Manufacturer	Model	Port Type	Type
Sony	DRX-S50U	USB	DVD-RW
Sony	DRX-S70U	USB	DVD-RW
Sony	AW-G170S	SATA	DVD-RW
Samsung	TS-H653A	SATA	DVD-RW
Panasonic	SW-9588-C	SATA	DVD-RW
Sony	DRX-S50U	USB	DVD-RW
BenQ	5232WI	USB	DVD-RW

Appendix D Compatible Displayer List

Please refer to the following sheet for the compatible device brand.

Brand	Model	Dimension (Unit: inch)
BENQ (LCD)	ET-0007-TA	19-inch (wide screen)
DELL (LCD)	E178FPc	17-inch
BENQ (LCD)	Q7T4	17-inch
BENQ (LCD)	Q7T3	17-inch
LENOVO (LCD)	LXB-L17C	17-inch
SANGSUNG (LCD)	225BW	22-inch (wide screen)
HFNOVO (CRT)	LXB-FD17069HB	17-inch
HFNOVO (CRT)	LXB-HF769A	17-inch
HFNOVO (CRT)	LX-GJ556D	17-inch
Samsung (LCD)	2494HS	24-inch
Samsung (LCD)	P2350	23-inch
Samsung (LCD)	P2250	22-inch
Samsung (LCD)	P2370G	23-inch
Samsung (LCD)	2043	20-inch
Samsung (LCD)	2243EW	22-inch
Samsung (LCD)	SMT-1922P	19-inch
Samsung (LCD)	T190	19-inch
Samsung (LCD)	T240	24-inch
LG (LCD)	W1942SP	19-inch
LG (LCD)	W2243S	22-inch
LG (LCD)	W2343T	23-inch
BENQ (LCD)	G900HD	18.5-inch
BENQ (LCD)	G2220HD	22-inch
PHILIPS (LCD)	230E	23-inch
PHILIPS (LCD)	220CW9	23-inch
PHILIPS (LCD)	220BW9	24-inch
PHILIPS (LCD)	220EW9	25-inch

Appendix E Compatible Switcher List

Please refer to the following sheet form compatible switcher list.

Brand	Model	Network Working Mode
D-Link	DES-1016D	10/100M self-adaptive
D-Link	DES-1008D	10/100M self-adaptive
Ruijie	RG-S1926S	There are five network modes: 1、 AUTO 2、 HALF-10M 3、 FULL-10M 4、 HALF-100M 5、 FULL-100M
H3C	H3C-S1024	10/100M self-adaptive
TP-LINK	TL-SF1016	10/100M self-adaptive
TP-LINK	TL-SF1008+	10/100M self-adaptive

Appendix F Compatible Wireless Mouse List

Please refer to the following sheet for compatible SD card brand.

Brand	Model
SUNT 讯拓™	V80
Rapoo	3500
Logitech	M215
Shuangfeiyan	Tianyao G7-630

Appendix G Earthing

1. What is the surge?

Surge is a short current or voltage change during a very short time. In the circuit, it lasts for microsecond. In a 220V circuit, the 5KV or 10KV voltage change during a very short time (about microseconds) can be called a surge. The surge comes from two ways: external surge and internal surge.

- The external surge: The external surge mainly comes from the thunder lightning. Or it comes from the voltage change during the on/off operation in the electric power cable.
- The internal surge: The research finds 88% of the surge from the low voltage comes from the internal of the building such as the air conditioning, elevator, electric welding, air compressor, water pump, power button, duplicating machine and other device of inductive load.

The lightning surge is far above the load level the PC or the micro devices can support. In most cases, the surge can result in electric device chip damage, PC error code, accelerating the part aging, data loss and etc. Even when a small 20 horsepower inductive engine boots up or stops, the surge can reach 3000V to 50000V, which can adversely affect the electronic devices that use the same distribution box.

To protect the device, you need to evaluate its environment, the lightning affection degree objectively. Because surge has close relationship with the voltage amplitude, frequency, network structure, device voltage-resistance, protection level, ground and etc. The thunder proof work shall be a systematic project, emphasizing the all-round protection (including building, transmission cable, device, ground and etc.). There shall be comprehensive management and the measures shall be scientific, reliable, practical and economic. Considering the high voltage during the inductive thundering, the International Electrotechnical Committee (IEC) standard on the energy absorbing step by step theory and magnitude classification in the protection zone, you need to prepare multiple precaution levels.

You can use the lightning rod, lightning strap or the lightning net to reduce the damage to the building, personal injury or the property,

- The lightning protection device can be divided into three types:
Power lightning arrester: There are 220V single-phrase lightning arrester and 380V three-phrase lightening arrester (mainly in parallel connection, sometimes use series connection) You can parallel connect the power lightning arrester in the electric cable to reduce the short-time voltage change and release the surge current. From the BUS to the device, there are usually three levels so that system can reduce the voltage and release the current step by step to remove the thunderstorm energy and guarantee the device safety. You can select the replaceable module type, the terminal connection type and portable socket according to your requirement.
- Signal lightning arrester: This device is mainly used in the PC network, communication system. The connection type is serial connection. Once you connected the signal lightning arrester with the signal port, it can cut the channel of the thunderstorm to the device, and on the other hand, it can discharge the current to the ground to guarantee the device proper

work. The signal lightning arrester has many specifications, and widely used in many devices such as telephone, network, analog communication, digital communication, cable TV and satellite antenna. For all the input port, especially those from the outdoor, you need to install the signal lightning arrester.

- Antenna feed cable lightning arrester: It is suitable for antenna system of the transmitter or the device system to receive the wireless signal. It uses the serial connection too.

Please note, when you select the lightning arrester, please pay attention to the port type and the earthing reliability. In some important environment, you need to use special shielded cable. Do not parallel connect the thunder proof ground cable with the ground cable of the lightning rod. Please make sure they are far enough and grounded respectively.

2. The earthing modes

We all know the earthing is the most complicated technology in the electromagnetism compatibility design since there is no systematic theory or module. The earthing has many modes, but the selection depends on the system structure and performance. The following are some successfully experience from our past work.

One-point ground: In the following figure you can see there is a one-point ground. This connection provides common port to allow signal to be transmitted in many circuits. If there is no common port, the error signal transmission occurred. In the one-point ground mode, each circuit is just grounded only and they are connected at the same port. Since there is only one common port, there is no circuit and so, there is no interference.

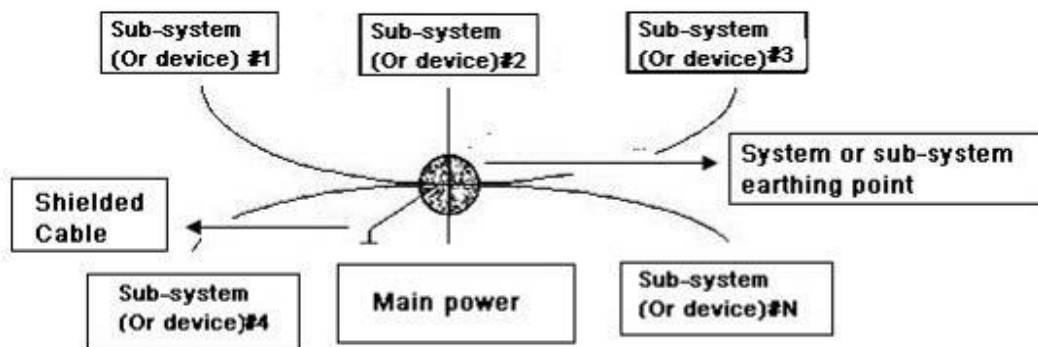

Multiple-point ground: In the following figure, you can see the internal circuit uses the chassis as the common point. While at the same time, all devices chassis use the earthing as the common port. In this connection, the ground structure can provide the lower ground resistance because when there are multiple-point grounds; each ground cable is as short as possible. And the parallel cable connection can reduce the total conductance of the ground conductor. In the high-frequency circuit, you need to use the multiple-point ground mode and each cable needs to connect to the ground. The length shall be less than the $1/20$ of the signal wavelength.

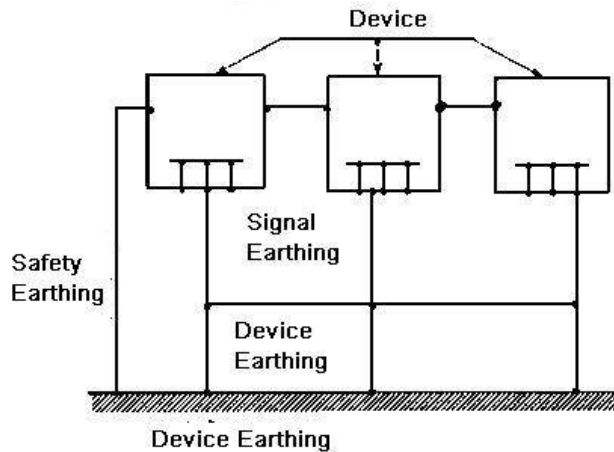

Mixed ground: The mixed ground consists of the features of the one-point ground and multiple-point ground. For example, the power in the system needs to use the one-point ground mode while the radio frequency signal requires the multiple-point ground. So, you can use the following figure to earth. For the direct current (DC), the capacitance is an open circuit and the circuit is one-point ground. For the radio frequency signal, the capacitance is conductive and the circuit adopts multiple-point ground.

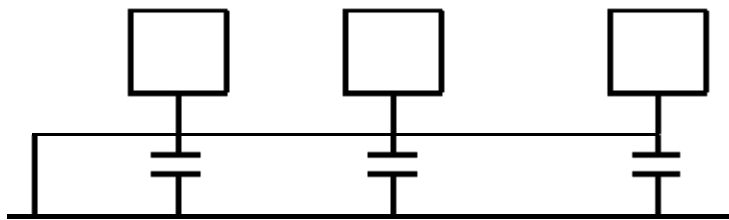

When connecting devices of huge size (the device physical dimension and connection cable is big comparing with the wave path of existed interference), then there are possibilities of interference when the current goes through the chassis and cable. In this situation, the interference circuit path usually lies in the system ground circuit.

When considering the earthing, you need to think about two aspects: The first is the system compatibility, and the other is the external interference coupling into the earth circuit, which results in system error. For the external interference is not regular, it is not easy to resolve.

3. Thunder proof ground method in the monitor system

- The monitor system shall have sound thunder proof earthing to guarantee personnel safety and device safety.
- The monitor system working ground resistance shall be less than 1Ω.
- The thunder proof ground shall adopt the special ground cable from the monitor control room to the ground object. The ground cable adopts copper insulation cable or wire and its ground section shall be more than 20mm².
- The ground cable of the monitor system can not short circuit or mixed connected with the strong alternative current cable.
- For all the ground cables from the control room to the monitor system or ground cable of other monitor devices, please use the copper resistance soft cable and its section shall be more than 4mm².

- The monitor system usually can adopt the one-point ground.
- Please connect the ground end of 3-pin socket in the monitor system to the ground port of the system (protection ground cable)

4. The shortcut way to check the electric system using the digital multimeter

For 220V AC socket, from the top to the bottom, E (ground cable), N (neutral cable), L(live cable). Please refer to the following figure.

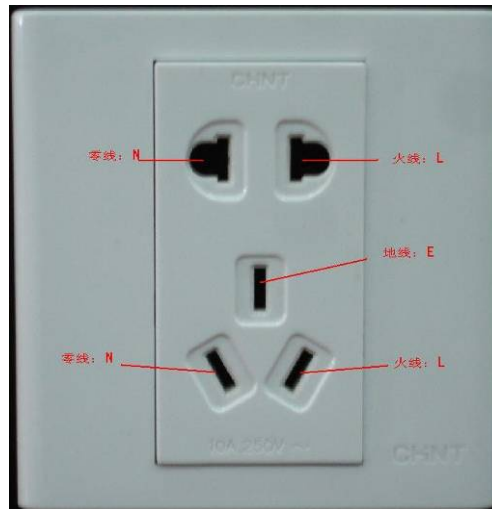

There is a shortcut way to check these three cables connection are standard or not (not the accurate check).

Importance

In the following operations, the multimeter range shall be at 750V!

For E (earth cable)

Turn the digital multimeter to 750V AC, use your one hand to hold the metal end, and then the other hand insert the pen to the E port of the socket. See the following figure. If the multimeter shows 0, then you can see current earth cable connection is standard. If the value is more than 10, then you can see there is inductive current and the earth cable connection is not proper.



For L (live cable)

Turn the digital multimeter to 750V AC, use your one hand to hold the metal end, and then the other hand insert the pen to the L port of the socket. See the following figure. If the multimeter shows 120, then you can see current live cable connection is standard. If the value is less than 60, then you can see current live cable connection is not proper or it is not the live cable at all.



For N (Neutral cable)

Turn the digital multimeter to 750V AC, use your one hand to hold the metal end, and then the other hand insert the pen to the N port of the socket. See the following figure. If the multimeter shows 0, then you can see current N cable connection is standard. If the value is more than 10, then you can see there is inductive current and the neutral cable connection is not proper. If the value is 120, then you can know misconnected the neutral cable to the live cable.

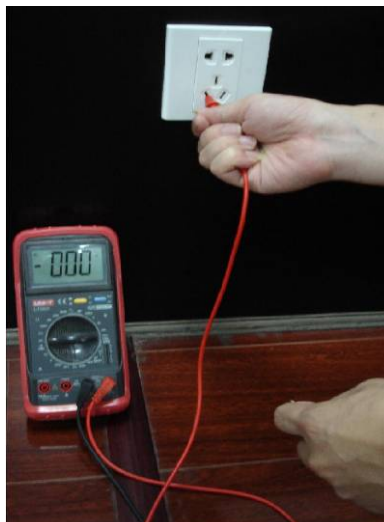

Appendix H Toxic or Hazardous Materials or Elements

Component Name	Toxic or Hazardous Materials or Elements					
	Pb	Hg	Cd	Cr VI	PBB	PBDE
Sheet Metal(Case)	○	○	○	○	○	○
Plastic Parts (Panel)	○	○	○	○	○	○
Circuit Board	○	○	○	○	○	○
Fastener	○	○	○	○	○	○
Wire and Cable/Ac Adapter	○	○	○	○	○	○
Packing Material	○	○	○	○	○	○
Accessories	○	○	○	○	○	○

Note

O: Indicates that the concentration of the hazardous substance in all homogeneous materials in the parts is below the relevant threshold of the SJ/T11363-2006 standard.

X: Indicates that the concentration of the hazardous substance of at least one of all homogeneous materials in the parts is above the relevant threshold of the SJ/T11363-2006 standard. During the environmental-friendly use period (EFUP) period, the toxic or hazardous substance or elements contained in products will not leak or mutate so that the use of these (substances or elements) will not result in any severe environmental pollution, any bodily injury or damage to any assets. The consumer is not authorized to process such kind of substances or elements, please return to the corresponding local authorities to process according to your local government statutes.

Note:

- This manual is for reference only. Slight difference may be found in the user interface.
- All the designs and software here are subject to change without prior written notice.
- All trademarks and registered trademarks mentioned are the properties of their respective owners.
- If there is any uncertainty or controversy, please refer to the final explanation of us.
- Please visit our website or contact your local retailer for more information.