

# XT-HDBT-EX70-4K-KIT

## User Manual



## Introduction

Our range of HDBaseT products offer the very best in performance and flexibility. The XT-HDBT-EX70-4K-KIT is an industry leading 4K HDBaseT solution delivering HDMI with HDCP 2.2 support, Bi-directional IR and PoH (PoE) up to lengths of 40m at 4K (70m at 1080p) over a single CAT cable.

---

### Key Features

- Advanced HDBaseT technology offering uncompressed video and audio with zero latency
- Extends HDMI up to a distance of 70m over single CAT cable
- Supports 4K UHD video up to 40m (3840 x 2160 @30Hz 4:4:4, 4096 x 2160 @24Hz 4:4:4, and 4K @60Hz 4:2:0)
- Supports all industry standard video resolutions including VGA-WUXGA and 480i-4K
- Supports 3D signal display
- Supports all known HDMI audio formats including Dolby TrueHD, Dolby Atmos, Dolby Digital Plus and DTS-HD Master Audio transmission
- Supports Bi-directional IR from input and output locations
- Supports Bi-directional PoH (Power over HDBaseT) to power extenders from either transmitter or receiver end
- HDCP 2.2 support

# Panel Description

## XT-HDBT-EX70-4K-TX

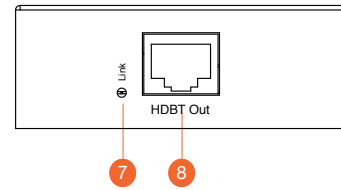
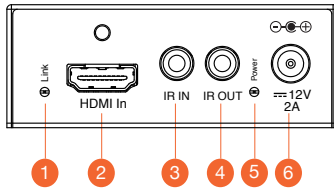

- 1 HDMI Link LED - LED will be lit when an active HDMI connection is detected.
- 2 HDMI input - Connect to the HDMI output of the local source device.
- 3 IR IN port - Connect to Xantech 12V IR Receiver (sold separately). Connection is used extend IR over the HDBaseT signal to control devices located at the XT-HDBT-EX70-4K-RX end.
- 4 IR OUT port - Connect to Xantech 12V Emitter (sold separately). Connection is used to control the local source device from Xantech IR Receiver connected at the XT-HDBT-EX70-4K-RX.

- 5 Power LED indicator
- 6 Power port - Connect Xantech 12V DC power supply only. Note - HDBaseT extender kit can be powered from either the Transmitter or Receiver by using the power over cable (POH) feature.
- 7 HDBaseT Link LED - LED will be lit when an active connection is established with the XT-HDBT-EX70-4K-RX.
- 8 HDBaseT output - RJ45 connector. Connect to HDBaseT input on XT-HDBT-EX70-4K-RX.

## XT-HDBT-EX70-4K-RX

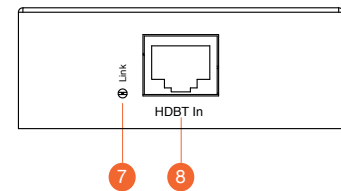
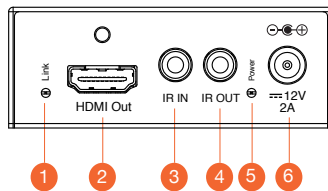

- 1 HDMI Link LED - LED will be lit when an active HDMI connection is detected.
- 2 HDMI Output - Connect to the HDMI input on local display device.
- 3 IR IN port - Connect to Xantech 12V IR Receiver (sold separately). Connection is used extend IR over the HDBaseT signal to control devices located at the XT-HDBT-EX70-4K-TX end.
- 4 IR OUT port - Connect to Xantech 12V Emitter (sold separately). Connection is used to control the local source or display device from Xantech IR Receiver connected at the XT-HDBT-EX70-4K-TX.

- 5 Power LED indicator.
- 6 Power port - Connect Xantech 12V DC power supply only. Note - HDBaseT extender kit can be powered from either the Transmitter or Receiver by using the power over cable (POH) feature.
- 7 HDBaseT input - RJ45 connector. Connect to HDBaseT output on XT-HDBT-EX70-4K-TX.
- 8 HDBaseT Link LED - LED will be lit when an active connection is established with the XT-HDBT-EX70-4K-TX.

## Understanding the XT-HDBT-EX70-4K-KIT HDBaseT status lights

The Xantech HDBaseT extender solution includes status LED indicators on both the Transmitter and Receiver products to show all connections are active and to help diagnose possible problems.

### Understanding the status lights:-

Xantech HT-HDBT-EX70-4K-TX

- The HDBaseT link light will be lit when a there is an active HDBaseT Receiver connected to the HDBaseT Transmitter
- The HDBaseT link light will be off when a there is no connection with a HDBaseT receiver
- The HDBaseT link light will blink if there is an unstable connection between the Xantech HDBaseT Transmitter and HDBaseT Receiver
- The HDMI link light will be off when there is no connection with a source device
- The HDMI link light will be on when there is an active connection with a source device

Xantech HT-HDBT-EX70-4K-RX

- The HDMI link light will be off when there is no connection with a display
- The HDMI link light will be on when there is an active connection with a display
- The HDBaseT link light will be off when there is no CAT cable/active HDBaseT connection on the RJ45 HDBaseT input
- The HDBaseT link light will blink if there is an unstable connection between the Xantech Transmitter and HDBaseT Receiver
- The HDBaseT link light will be lit when a there is an active HDBaseT Transmitter connected to the HDBaseT Receiver

---

## Terminating the interconnecting HDBaseT CAT cable

It is important that the interconnecting CAT cable between the Xantech HDBaseT products is terminated using the correct RJ45 pin configuration. The link CAT cable **MUST** be a 'straight' (pin-to-pin) CAT cable and it is advised that this is wired to the T568B wiring standard as this format is less prone to EMI (Electro-Magnetic Interference).

When installing CAT cables it is advised that you use the best possible CAT cable quality possible. HDMI distribution products will only work if used with CAT5e standard cable or above. Xantech recommends using a CAT6 (or better) cable for your installations, especially when running over longer distances, in areas of high EMI, or for 4K signal distribution.

### RJ45 Wiring - T568B

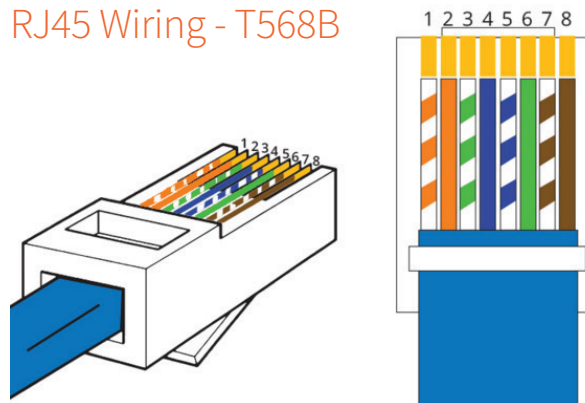



Example Schematic  
XT-HDBT-EX70-4K-KIT

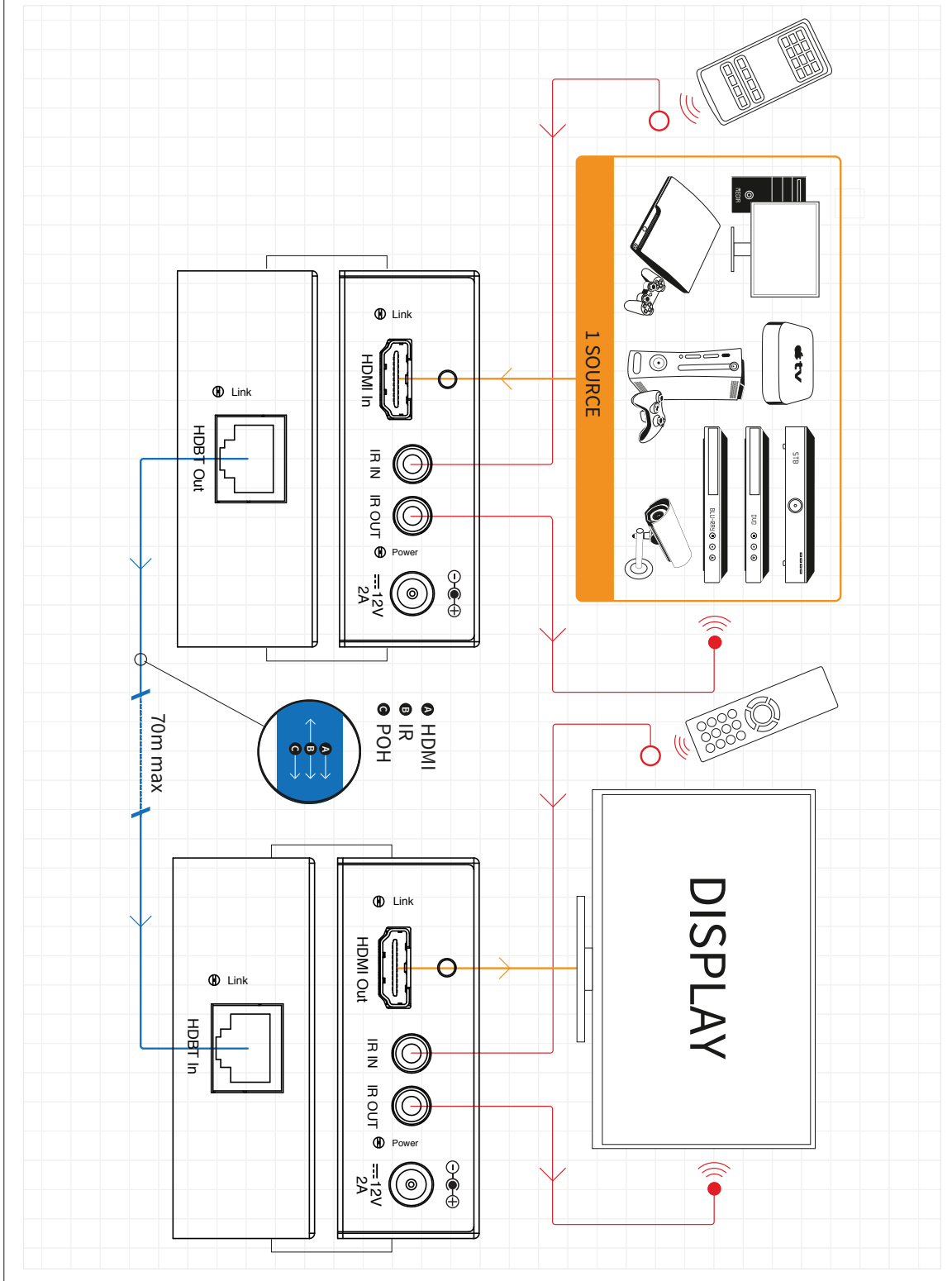
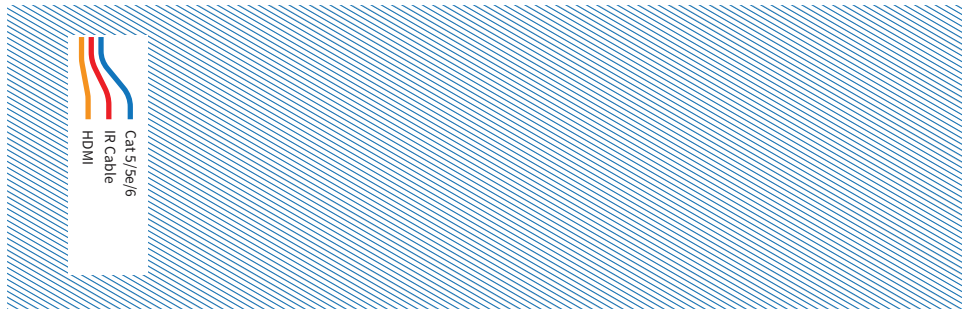

## Specifications:

### XT-HDBT-EX70-4K-TX

**Video Input Connectors:** 1x HDMI Type A, 19-pin female

**Video Output Connectors:** 1x HDBaseT™ RJ45 connector

**IR Input Ports:** 1x 12V 3.5mm stereo jack

**IR Output Ports:** 1x 12V 3.5mm mono jack

**Casing Dimensions (W x H x D):** 104mm x 27mm x 73mm

**Dimensions Inc. Connections (W x H x D):** 108mm x 27mm x 73mm

### XT-HDBT-EX70-4K-RX

**Video Input Connectors:** 1x HDBaseT™ RJ45 connector

**Video Output Connectors:** 1x HDMI Type A, 19-pin female

**IR Input ports:** 1x 12V 3.5mm stereo jack

**IR Output ports:** 1x 12V 3.5mm mono jack

**Casing Dimensions (W x H x D):** 104mm x 27mm x 73mm

**Dimensions Inc. Connections (W x H x D):** 108mm x 27mm x 73mm

**Shipping Weight:** 1.0Kg

**Operating Temperature:** 32°F to 104°F (0°C to 40°C)

**Storage Temperature :** -4°F to 140°F (-20°C to 60°C)

**NOTE:** Specifications are subject to change without notice.

---

## Package Contents:

- 1x XT-HDBT-EX70-4K-TX
- 1x XT-HDBT-EX70-4K-RX
- 1x 12V/2A DC power supply
- 2x Mounting kit
- 1x Quick reference guide

## Certifications

### FCC Notice

This equipment has been tested and found to comply with the limits for a Class B digital device, pursuant to part 15 of the FCC Rules. These limits are designed to provide reasonable protection against harmful interference in a residential installation. This equipment generates, uses, and can radiate radio frequency energy and, if not installed and used in accordance with the instructions, may cause harmful interference to radio communications. However, there is no guarantee that interference will not occur in a particular installation. If this equipment does cause harmful interference to radio or television reception, which can be determined by turning the equipment off and on, the user is encouraged to try to correct the interference by one or more of the following measures:

- Reorient or relocate the receiving antenna.
- Increase the separation between the equipment and receiver.
- Connect the equipment into an outlet on a circuit different from that to which the receiver is connected.
- Consult the dealer or an experienced radio/TV technician for help.

**CAUTION** - changes or modifications not expressly approved by the party responsible for compliance could void the user's authority to operate the equipment.

### CANADA, INDUSTRY CANADA (IC) NOTICES

This Class B digital apparatus complies with Canadian ICES-003.

Operation is subject to the following two conditions: (1) this device may not cause interference, and (2) this device must accept any interference, including interference that may cause undesired operation of the device.

### CORRECT DISPOSAL OF THIS PRODUCT

This marking indicates that this product should not be disposed with other household wastes. To prevent possible harm to the environment or human health from uncontrolled waste disposal, recycle it responsibly to promote the sustainable reuse of material resources. To return your used device, please use the return and collection systems or contact the retailer where the product was purchased. They can take this product for environmentally safe recycling.

**main:**  
1 (800) 472-5555 - US  
1 (707) 283-5900 - International  
1 (707) 283-5901 - Fax

**tech support:**  
tech@xantech.com

**web:**  
www.xantech.com