

RS42-EZ

4" Open-Ceiling Speaker

SOUNDTUBE
ENTERTAINMENT



Specifications: RS42-EZ

Mounting hardware included

System Type	4.0" Coax, open-ceiling, ported (20 Watt transformer for 25/70.7/100 Volt or voice coil direct)
Nominal Impedance	16 ohm
Impedance (minimum)	16.0 ohm
Sensitivity dB @ 2.83V/1M	84.0dB
Sensitivity dB @ 1W/1M (2)	87.0dB
Frequency Response (± 3 dB)	140 Hz - 22 kHz
Frequency Response (± 10 dB)	100 Hz - 22 kHz
Max. Program Power	40w
Max. Continuous Power RMS	20w
Max. Power SPL @ 1 M	100.0dB
Tap Selector	6 Position rotary switch with transformer bypass
70.7 Volt Transformer Taps	20w / 100.0dB
100 Volt Transformer Taps (dB)	20w / 100.0dB
25 Volt Transformer Taps (dB)	2.5w / 91.0dB
Transformer Options	25 / 70.7 / 100 Volt option with a 16 Ohm direct
Colors	Black or white
Tweeter - part	19mm (0.75in) Silk dome w/ BroadBeam Ring™
Woofer - part	4" Polypropylene Cone with Butyl Rubber Surround
Inputs	4 position ceramic terminal connector
Height (SM = Height)	199.6 mm / 7.85 in
Diameter (SM = Width)	189.5 mm / 7.46 in
Carton length	241.3 mm / 9.50 in
Weight	1.4 kg / 3.08 lb
Shipping Weight	1.8 kg / 3.96 lb
Accessories Optional	Beam Clamp (AC-BC-1), Split Loom Tubing (AC-SLT-10), Hanging Kit (AC-RSEZ-HH-10), Hanging Kit (AC-RSEZ-HH-20), 50' Hanging Kit (AC-RSEZ-HH-50), Forged Eyebolt (AC-FE1), Snap Link (AC-SL-1)
Packaging	1 per box
Regulatory - UL	1480 planned
Regulatory - CE	Approved
Regulatory - IP	not planned
Regulatory - CCC	approved

RS42-EZ

4" Open-Ceiling Speaker

SOUNDTUBE
ENTERTAINMENT

Key Features

- One 6.5 inch (133 mm) coaxial driver with BroadBeam Ring™ technology for high frequency dispersion.
- Weatherized components for indoor and outdoor applications.
- Includes hanging hardware with galvanized steel cables and hanging bracket for fast, easy and secure installation. Unit may be hung or mounted direct-to-conduit via locking cover plate.
- Enclosure constructed of injection molded ABS with glass fiber reinforcement for lasting durability in indoor or outdoor applications.
- Easy access six-position rotary switch for 25-, 70.7- and 100-volt applications with transformer bypass position.
- Aluminum grille with protective powdercoated finish.
- Built-in thermal fuse.
- Unit ships in eco-friendly, recyclable packaging.
- UL 1480 UEAY& UL 2239 listed.
- High-quality black or white paint finish. Speaker is paintable.
- Included accessories: hanging hardware, weather plug, cover plate.

Description

One 4 inch (102 mm) coaxial driver with BroadBeam Ring™ technology for consistently smooth high frequency directivity. Includes hanging hardware with galvanized steel cables and hanging bracket for fast, easy and secure installation. Unit may be hung or mounted direct-to-conduit via locking cover plate. Enclosure constructed of injection molded ABS with glass fiber reinforcement for lasting durability in indoor or outdoor applications. 16 ohm impedance for easy daisy chaining in low voltage systems. Aluminum grille with protective powder coated finish. Built-in thermal fuse. Ceramic input terminal accepts up to 10 gauge plenum rated signal wire and includes thermal fuse. Suitable for use in voice alarm applications subject to EU regulations EN60849 and BS5839-8. Unit ships in eco-friendly, recyclable packaging. UL 1480 UEAY and UL 2239 listed. Included accessories: hanging hardware, weather plug, cover plate, AC-RSEZ-HH-10, and AC-RSEZ-HH-10.

Applications

Designed for superior off-axis performance and easy installation, the RS62-EZ offers attractive styling in an economical speakers for open-ceiling uses. The RS62- EZ includes hanging cables and a built in mounting plate for suspending the speaker and a threaded opening on top of it's cover plate for direct-to-conduit mounting. Costeffective engineering with high-performance sound makes the RS62-EZ speaker ideal for music and paging applications in retail, grocery stores, restaurants, hotels, casinos, museums, trade shows and conference rooms. For applications where additional bass is required, SoundTube's RS1001i-II-T 10-inch subwoofer may be used.

Patented SoundTube Technologies

SoundTube and MSE Audio Group constantly develop new technologies that enhance audio product performance. SoundTube innovations are protected by multiple U.S. and international patents, which explicitly cover SoundTube dispersion, enclosure and dome technologies. MSE Audio Group actively defends its patents in order to protect SoundTube resellers and end users.

Technical Data and Specification Tools

Technical Data

SoundTube Entertainment strives to provide complete and effective technical information and data to dealers, engineers and designers. All data are available from SoundTube Entertainment or at www.soundtube.com. Technical data and downloads include: EASE™ data - 3-D polar plots. EASE™ Address - 2-D modeling for distributed systems Autodesk® Revit® software Tech

Sheets - Technical information and architectural specs for system engineers SoundTubeSPEC™ - Proprietary speaker placement software

Data Acquisition and Verification

All data for SoundTube speakers are independently collected from and verified by NWA Labs (www.nwaalabs.com) using their proprietary MACH testing system. All data are collected and analyzed according to ASTM, ISO and AES standards using EASRA, TEF and MLSSA. Full balloon data including both phase and magnitude are compiled into a variety of formats including EASE 4.x, GLL and CLF.

Architectural Specifications

The loudspeaker shall consist of one 165 mm (6.5 in.) low frequency driver and one 25.4 mm (1.0 in.) high frequency driver. The low frequency voice coil diameter shall be 25.4 mm (1.0 in.). Performance specifications of a typical production unit shall be as follows: Useable frequency response shall extend from 80 Hz - 22 kHz (-10 dB). Measured sensitivity (2.83-volt input, 1 meter) shall be at least 86.0 dB. The speaker shall have a nominal impedance of 16 ohms. The speaker shall be available for 25-, 70.7- and 100-volt modes and shall include a six-position tap switch with a transformer bypass position. Rated power capacity shall be at least 32 watts continuous (RMS) and conform to EIA- 426-B testing. Maximum continuous output at 1 meter shall be 104.0 dB. The low frequency transducer shall have a polypropylene cone with a butyl rubber surround. The high frequency transducer shall have a silk dome tweeter with BroadBeam Ring™ technology. Installation shall be by galvanized steel cable attached to the speaker chassis via fixed cable end that interlocks with integrated mounting bracket. The external wiring input connector shall be a four-position ceramic terminal block for low impedance or distributed systems and shall accept from 10 - 22-gauge wire. The system shall be for indoor and outdoor applications and shall have a weather-resistant plug protecting all wire connectors inside the cover plate. The enclosure shall be constructed of injection-molded ABS. The grille shall be constructed of powder-coated aluminum for lasting performance in the elements. Overall cabinet dimensions shall be no more than 264.2 mm (10.4 in.) in height by 256.0 mm (10.08 in.) in diameter. The unit shall weigh no more than 3.2 kg (7.0 lbs.) and shall include hanging hardware and weather-resistant cover plate plug. The system shall be the SoundTube RS62-EZ with hanging hardware for both low- and high-impedance applications.

SoundTube

8005 W. 110th St. | Suite 208

Overland Park, KS 66210

Phone 9136635600

Fax 8556635600

Toll Free 8556635600

<http://soundtube.mseaudio.com>

All SoundTube products come with a 5-year limited warranty.

Graphs and Plots

Frequency Response
(dB) Level, Sound pressure

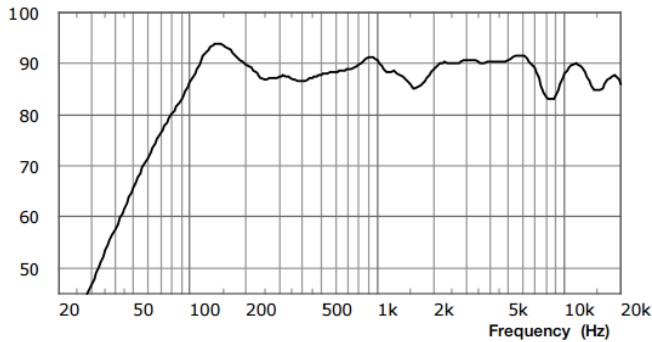

Impedance/Phase

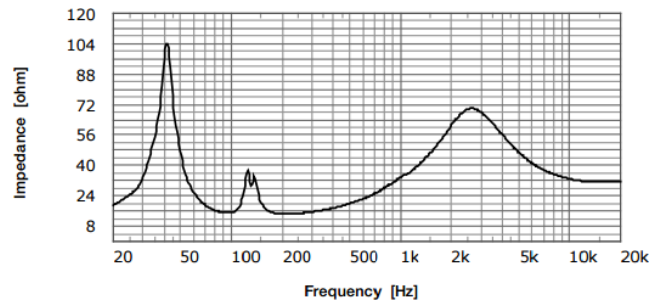

Vertical Beamwidth
(W) Power

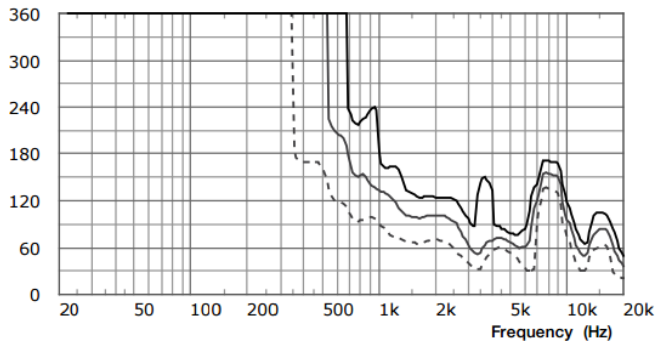

Directivity Index (DI)
(W) Power

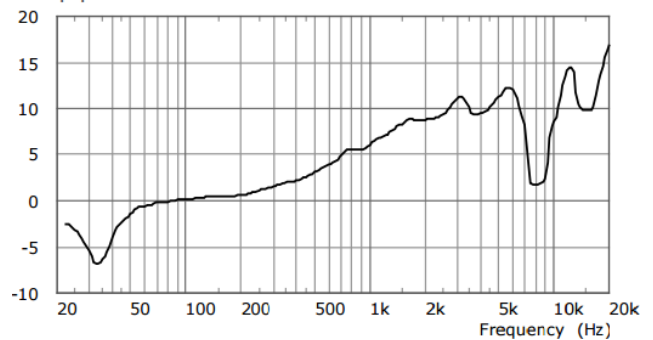

1W@4m - EN54-24 Compliance

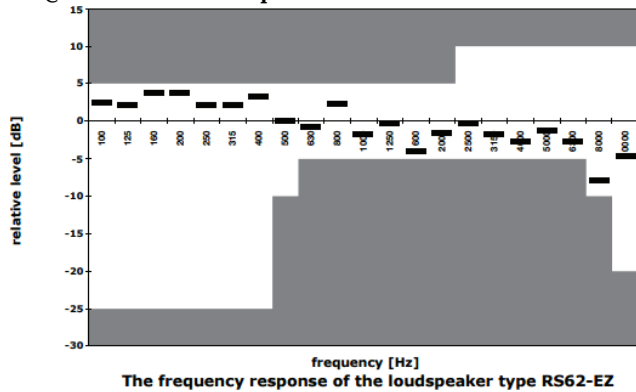

RS62-EZ:

Octave band filter	Declared coverage angle	Measured coverage angle
500 Hz / 1W/4m	360	360
1 kHz / 1W/4m	150	150
2 kHz / 1W/4m	105	102,5
4 kHz / 1W/4m	74	70

125 Hz

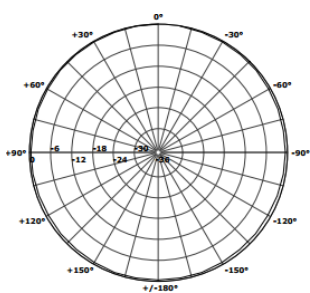

250 Hz

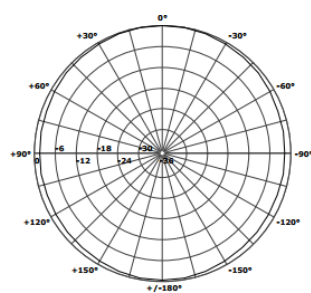

500 Hz

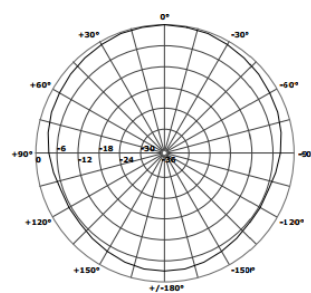

500 Hz

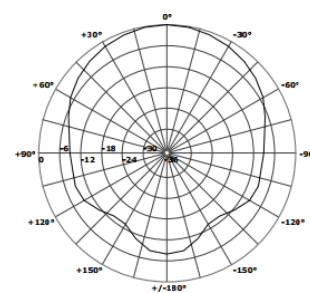

2,000 Hz

4,000 Hz

8,000 Hz

8,000 Hz

RS42-EZ

4" Open-Ceiling Speaker

SOUNDTUBE
ENTERTAINMENT

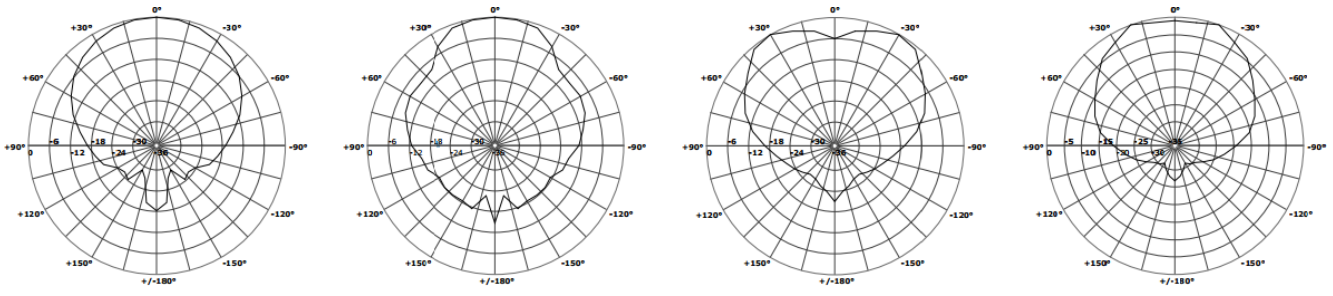

RS42-EZ

4" Open-Ceiling Speaker

SOUNDTUBE
ENTERTAINMENT

Mechanical Drawings

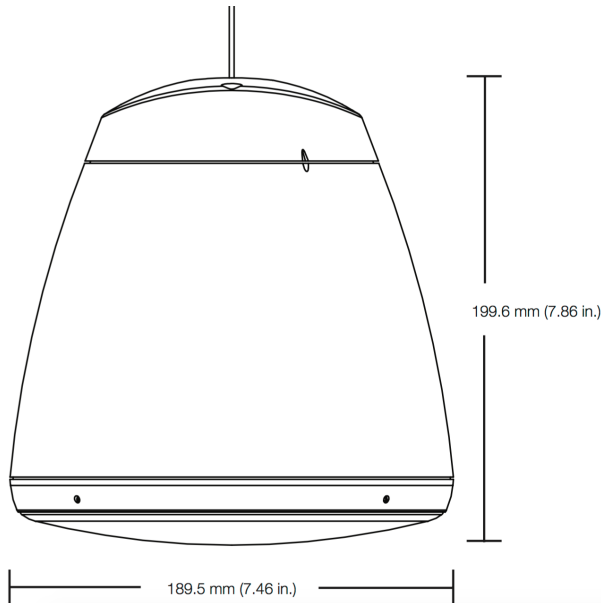

Optional Accessories

Beam Clamp (AC-BC-1)

Hanging Kit (AC-RSEZ-HH-20)

Snap Link (AC-SL-1)

Split Loom Tubing (AC-SLT-10)

50' Hanging Kit (AC-RSEZ-HH-50)

Hanging Kit (AC-RSEZ-HH-10)

Forged Eyebolt (AC-FE1)