

SD500 SERIES IP SPEED DOME CAMERA HD/4K/STARLIGHT

USER MANUAL

VERSION: SD5IP-M-06102017

S TYPE



L TYPE



Contents

PART ONE: PTZ CAMERA USER MANUAL	4
IMPORTANT INFORMATION	4
OVERVIEW	7
FEATURES.....	7
WHAT’S IN THE BOX.....	8
ACCESSORIES- OPTIONAL.....	8
CAMERA DIAGRAMS	9
TAIL-CABLE	10
INSTALLING YOUR CAMERA	12
CHECK CAMERA COMPONENTS AND INSTALLATION CONDITIONS	12
POWER INPUT	12
MOUNTING THE CAMERA	14
STARTING THE CAMERA	14
SETTING CAMERA OVER THE LAN	14
ACCESSING YOUR CAMERA.....	15
INSTALLING THE ACTIVE X.....	15
PART TWO: NETWORK CAMERA USER MANUAL	16
NETWORK CONNECTION	16
LOGIN	16
LOGGING IN TO THE WEB INTERFACE	18
INTRODUCTION TO THE WEB INTERFACE	19
INITIAL CONFIGURATION.....	19
CONFIGURING PARAMETERS	20
LOCAL PARAMETERS	20
NETWORK CONFIGURATION	21
TCP/IP.....	21
PPPoE	22
DHCP	22
PORT	22
IMAGE CONFIGURATION	24
IMAGE ADJUSTMENT	24
AUDIO AND VIDEO CONFIGURATION	32
VIDEO CONFIGURATION	32
VIDEO FORMAT	33
VIDEO COMPRESSION	33
AUDIO CONFIGURATION.....	33
ROI.....	34
MEDIA STREAM CONFIGURATION.....	34
ALARM CONFIGURATION	35
CONFIGURING MOTION DETECTION ALARM	35
MEMORY CARD STORAGE.....	39
SYSTEM MAINTENANCE	41
SECURITY.....	41

SETTING THE SYSTEM TIME	42
SETTING SERVERS.....	43
SERIAL PORT MODE CONFIGURATION	43
MAINTENANCE.....	46
UPGRADING THE DEVICE.....	46
RESTARTING THE SYSTEM.....	46
IMPORTING AND EXPORTING SYSTEM CONFIGURATION FILE	47
COLLECTING DIAGNOSTIC INFORMATION	47
DIGITAL ZOOM & FOCUS CONFIGURATION.....	47
LIVE VIEW	48
LIVE VIEW TOOLBAR	49
VIEWING CERTAIN AREA OF IMAGES	50
USING 3D POSITIONING	50
VIDEO PLAYBACK AND DOWNLOAD WITH EDGE STORAGE	50
PTZ CONTROL.....	51
SETTING PATROL BY PRESETS.....	52
APPENDIX A GLOSSARY	55
SPECIFICATIONS	56
HD MODELS	56
STARLIGHT MODELS	57
4K MODELS	58
DIMENSIONS.....	59
MODEL: BL-PP80 (80W PoE POWER INJECTOR)	61

Part One: PTZ Camera User Manual

Operating Instructions

Thank you for purchasing our product. If there are any questions, please contact the authorized dealer.

Before operating the unit, please read this manual thoroughly and retain it for future reference.

Copyright

Copyright 2015-2016 Bolin Technology all rights reserved. No part of this manual may be copied, reproduced, translated, or distributed in any form or by any means without prior consent in writing from our company.

Trademark Acknowledgement

 and other Bolin's trademarks and logos are the property of Bolin Technology. Other trademarks, company names and product names contained in this manual are the property of their respective owners.

IMPORTANT INFORMATION

Legal Notice

Attention:

To ensure account security, please change the password after your first login. You are recommended to set a strong password (no less than eight characters).

The contents of this document are subject to change without prior notice. Updates will be added to the new version of this manual. We will readily improve or update the products or procedures described in the manual.

Best effort has been made to verify the integrity and correctness of the contents in this document, but no statement, information, or recommendation in this manual shall constitute formal guarantee of any kind, expressed or implied. We shall not be held responsible for any technical or typographical errors in this manual.

The product appearance shown in this manual is for reference only and may be different from the actual appearance of your device.

This manual is a guide for multiple product models and so it is not intended for any specific product.

In this manual, the illustrations of displayed interface, parameters displayed, drawings and value ranges may vary with models. Please see the actual product for details.

Due to uncertainties such as physical environment, discrepancy may exist between the actual values and reference values provided in this manual.

Use of this document and the subsequent results shall be entirely on the user's own responsibility.

Disclaimer

CAUTION!

The default password is used for your first login. To ensure account security, please change the password after your first login. You are recommended to set a strong password (no less than eight characters).

- To the maximum extent permitted by applicable law, the product described, with its hardware, software, firmware and documents, is provided on an "as is" basis.
- Best effort has been made to verify the integrity and correctness of the contents in this manual, but no

statement, information, or recommendation in this manual shall constitute formal guarantee of any kind, expressed or implied. We shall not be held responsible for any technical or typographical errors in this manual. The contents of this manual are subject to change without prior notice. Update will be added to the new version of this manual.

- Use of this manual and the subsequent result shall be entirely on the user's own responsibility. In no event shall we be liable to you for any special, consequential, incidental, or indirect damages, including, among others, damages for loss of business profits, business interruption, or loss of data or documentation in connection with the use of this product.
- Video and audio surveillance can be regulated by laws that vary from country to country. Check the law in your local region before using this product for surveillance purposes. We shall not be held responsible for any consequences resulting from illegal operations of the device.
- The illustrations in this manual are for reference only and may vary depending on the version or model. The screenshots in this manual may have been customized to meet specific requirements and user preferences. As a result, some of the examples and functions featured may differ from those displayed on your monitor.
- This manual is a guide for multiple product models and so it is not intended for any specific product.
- Due to uncertainties such as physical environment, discrepancy may exist between the actual values and reference values provided in this manual. The ultimate right to interpretation resides in our company.

Environmental Protection

This product has been designed to comply with the requirements on environmental protection. For the proper storage, use and disposal of this product, national laws and regulations must be observed.

Symbols

The symbols in the following table may be found in this manual. Carefully follow the instructions indicated by the symbols to avoid hazardous situations and use the product properly.

WARNING! : Indicates a hazardous situation which, if not avoided, could result in bodily injury or death.

CAUTION! : Indicates a situation which, if not avoided, could result in damage, data loss or malfunction to product.

NOTE: Indicates useful or supplemental information about the use of product.

Safety Information

WARNING!

Installation and removal of the unit and its accessories must be carried out by qualified personnel. You must read all of the Safety Instructions supplied with your equipment before installation and operation.

Warnings:

- If the product does not work properly, please contact your dealer. Never attempt to disassemble the camera yourself. (We will not assume any responsibility for problems caused by unauthorized repair or maintenance.)
- This installation should be made by a qualified service person and should conform to all the local codes.
- When shipping, the camera should be packed in its original packaging.
- Make sure the power supply voltage is correct before using the camera.
- Do not drop the camera or subject it to physical shock.
- Do not touch sensor modules with fingers. If cleaning is necessary, use a clean cloth with a bit of ethanol and wipe it gently. If the camera will not be used for an extended period of time, put on the lens cap to protect the sensor from dirt.
- Do not aim the camera lens at the strong light such as sun or incandescent lamp. The strong light can cause fatal damage to the camera.

Maintenance Precautions:

- If there is dust on the front glass surface, remove the dust gently using an oil-free brush or a rubber dust blowing ball.
- If there is grease or a dust stain on the front glass surface, clean the glass surface gently from the center outward using anti-static gloves or an oil-free cloth. If the grease or the stain still cannot be removed, use anti-static gloves or an oil-free cloth dipped with detergent and clean the glass surface gently until it is removed.
- Do not use organic solvents, such as benzene or ethanol when cleaning the front glass surface.

Regulatory Compliance

FCC Part 15

This equipment has been tested and found to comply with the limits for digital device, pursuant to part 15 of the FCC Rules. These limits are designed to provide reasonable protection against harmful interference when the equipment is operated in a commercial environment. This equipment generates, uses, and can radiate radio frequency energy and, if not installed and used in accordance with the instruction manual, may cause harmful interference to radio communications. Operation of this equipment in a residential area is likely to cause harmful interference in which case the user will be required to correct the interference at his own expense.

This product complies with Part 15 of the FCC Rules. Operation is subject to the following two conditions:

This device may not cause harmful interference.

This device must accept any interference received, including interference that may cause undesired operation.



LVD/EMC Directive

This product complies with the European Low Voltage Directive 2006/95/EC and EMC Directive 2004/108/EC.



WEEE Directive–2002/96/EC

The product this manual refers to is covered by the Waste Electrical & Electronic Equipment (WEEE) Directive and must be disposed of in a responsible manner.

Overview

This user guide is suitable for the following models:

If the model numbers that have following letter included in the end, means some extra features included:

1. A - with Full Functionality Tail-Cable with Alarm input and output, etc.
2. P – with POE
3. W – with Wiper

S TYPE:

- SD530BHD-IRNA (IP)
- SD530BHD-IRNAW (IP, Wiper)
- SD530BHD-IRNAP (IP, POE)
- SD530BHD-IRNAWP (IP, Wiper, POE)

L TYPE:

- SD522B4K-IRNA (IP)
- SD522B4K-IRNAW (IP, Wiper)
- SD522B4K-IRNAP (IP, POE)
- SD522B4K-IRNAWP (IP, Wiper, POE)
- SD520BHD-IRNXGA (IP)
- SD520BHD-IRNXGAW (IP, Wiper)
- SD520BHD-IRNXGAP (IP, POE)
- SD520BHD-IRNXGAWP (IP, Wiper, POE)

Features

- Supports Various Resolutions: 12MP,4K(8MP), 6MP,5MP,3MP, 1080P, 720P (Model Specific)
- Supports Various Zoom: 20X, 22X, 30X
- Video Output: IP
- Video Compression: H.264/H.265, MJPEG
- ZDP - Zero Deviation Positioning technology for high accuracy.
- Silent motor driver solution
- Intelligent Adaptive IR Illumination up to 100 meters.
- Outdoor Environmental Rating: IP67
- Corrosion Resistant treatment.
- Power Input: AC 24V. PoE 80W (Bolin PoE 80W Injector needed, optional).
- Supports ONVIF Profile S
- Various Image Functionalities: WDR, BLC, Defog, Day/Night
- Supports $\pm 120^\circ$ tilt / $\pm 360^\circ$ pan range, adaptive speed up to $150^\circ/s$
- Supports 255 Presets, Adaptive Speed: $150^\circ/s$, 8 Cruises
- Supports 3D Positioning Feature
- Supports Motion Detection, Guard Tour Presets: 4 Zones
- Supports Preset Time Task Activation: 8 Periods
- Supports 1 alarm input/output, 1 audio input/ output, RS-485 control (Not Activated), (Tail-Cable Type A)
- Rain wiper available(Optional)

WHAT'S IN THE BOX

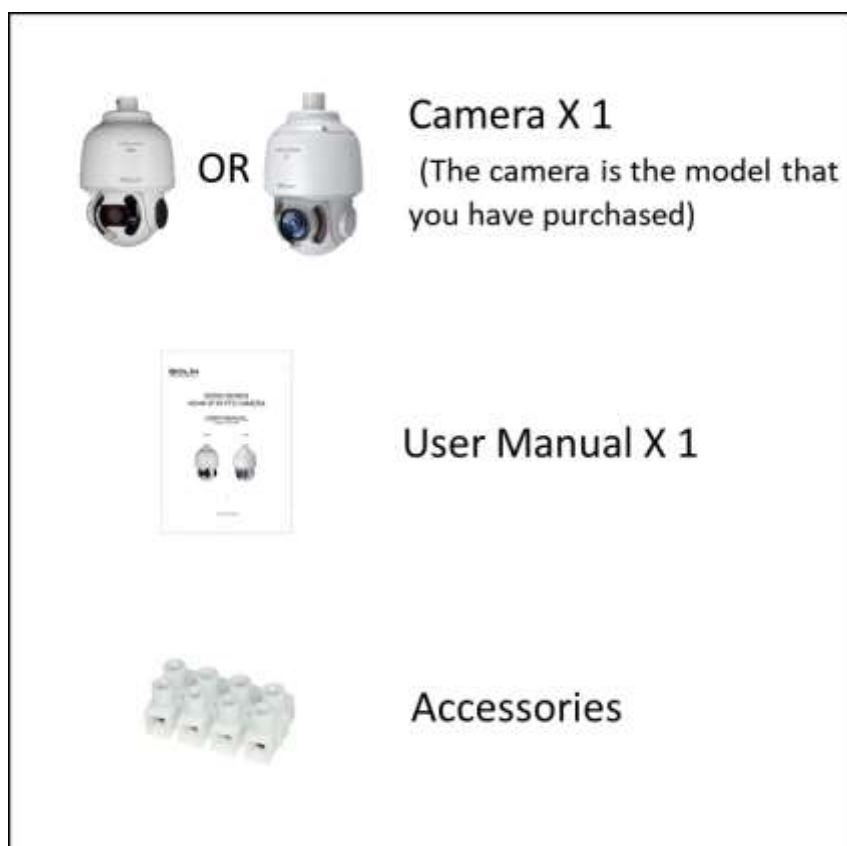

Accessories- Optional



Camera Diagrams

Camera



1. IR LED Illuminator
2. Lens
3. Rain Wiper



BL-PP80 80w PoE Power Injector (Optional)

1. Data/Power Output (Connect to the specific PoE camera, Power Consumption:80w, port of speed: 100/1000Mbps adaptive)
2. Data in (Connect to network switch)
3. DC 48V Power Input Port
4. Power Indicator

Tail-Cable

All cables are tagged to indicate their functions separately. The cables available may vary with the product model. There are two types of Tail-Cable available for SD500 series PTZ camera.

1. Type A-Cable: Full function cable with audio and alarm
2. Type N-Cable: Only IP video out and Power

Cable Connection

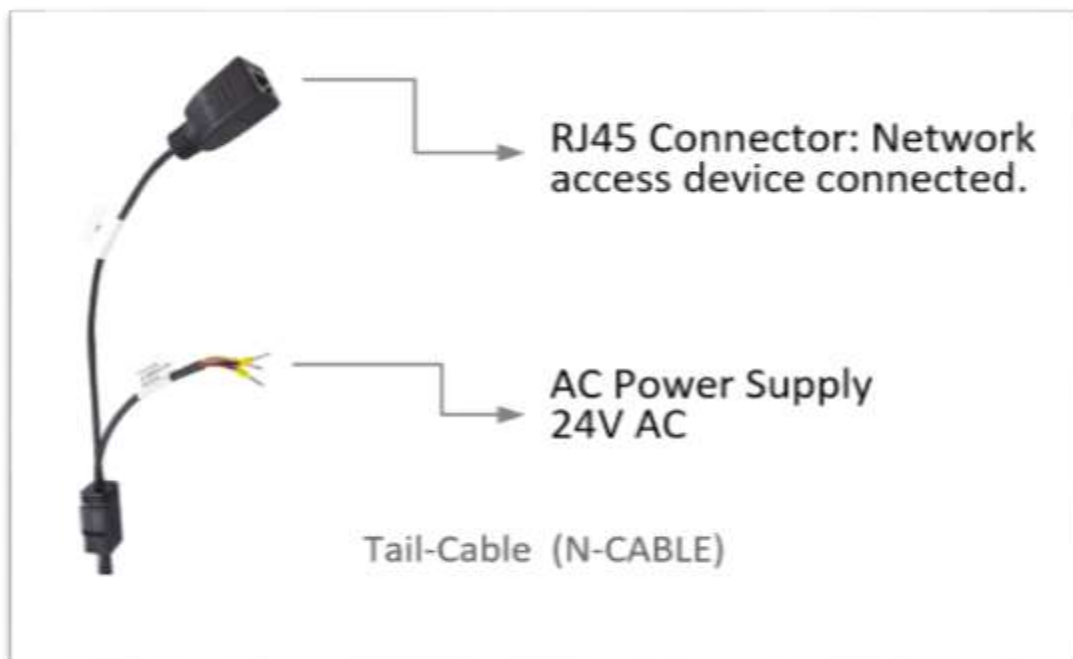
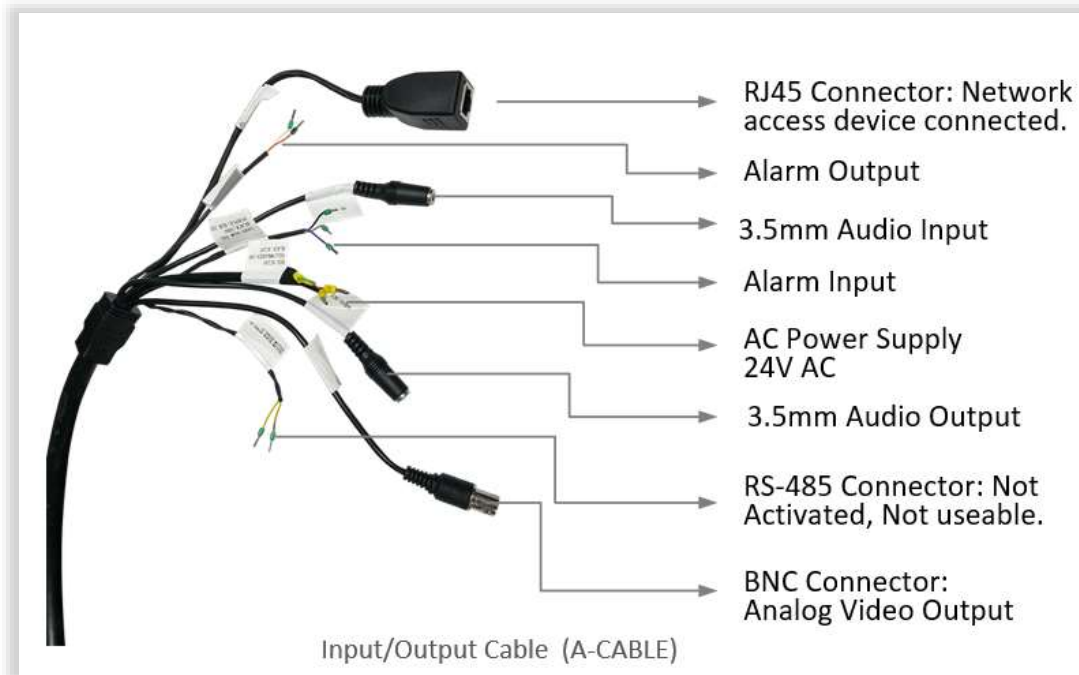

N-Cable Connection

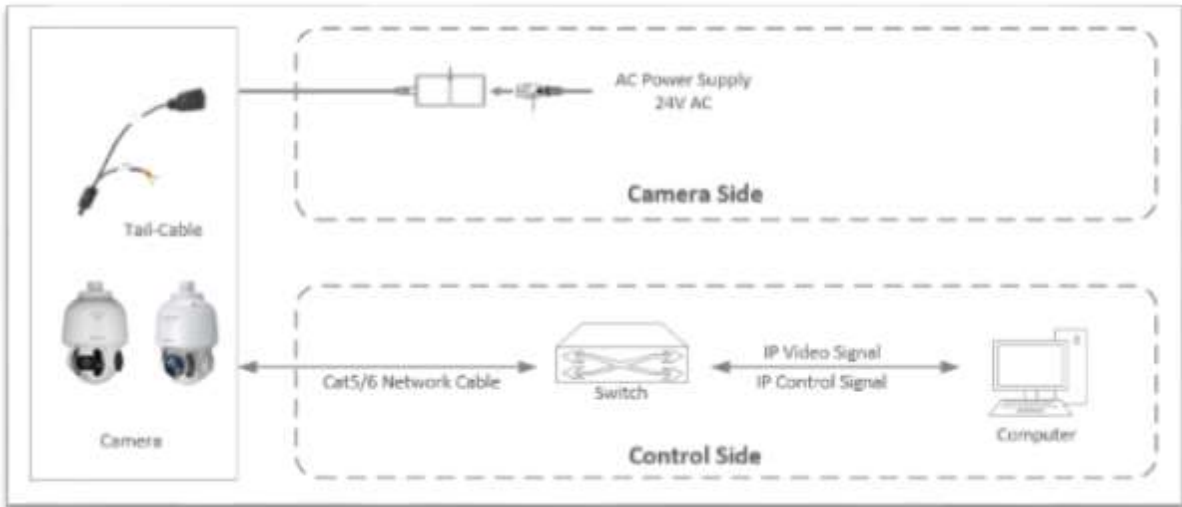

A-Cable Connection

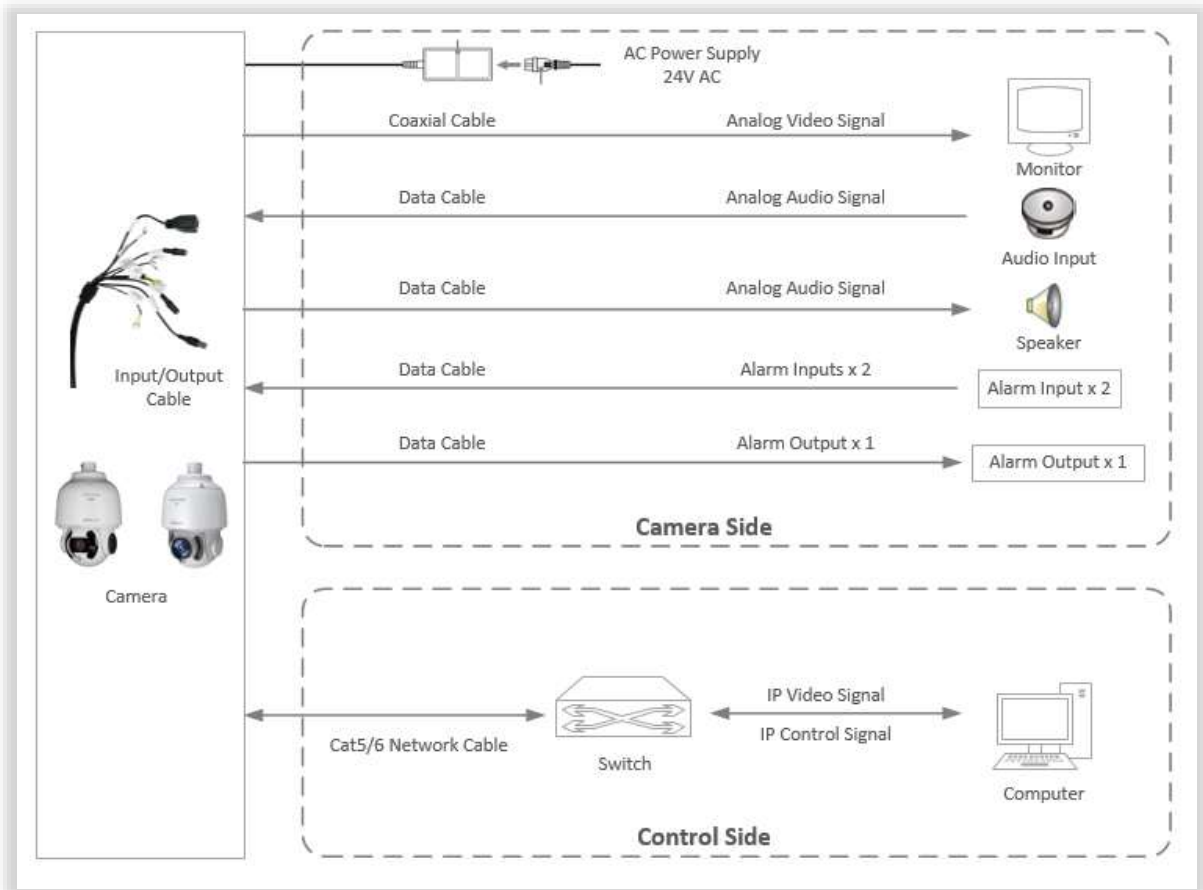

NOTE:

- Use water proof/ IP67 rated junction box/ connection box to protect the RJ45 and other connections. A water proof RJ45 connector is available on some models.

Installing Your Camera

The following diagrams are for your reference only. See the actual product to mount your camera.

Check Camera Components and Installation Conditions

Before mounting your camera, check the device model number and included contents against the packing list to ensure components are complete.

Camera Structure

1. Tail-Cable
2. Camera Body

Important

- Verify the bearing capacity of the mounted position
- Verify that the mounted position meets the bearing requirements. Otherwise, you are advised to reinforce the mounted position for the device weight. For more information, see the product datasheet.
- Verify lightning protection and grounding requirements
- Select proper lightning protection devices for the power supply, audio and video signal interfaces, and RS485 interfaces.
- Ground the terminal properly.

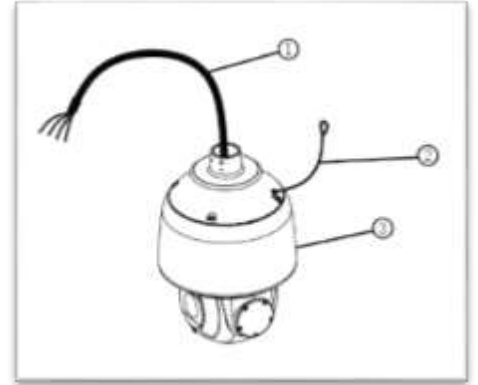

Cable Requirements

Network Cable

10/100 Mbps Ethernet CAT 5/5E/6 UTP cables are applicable to the ANSI/EIA/TIA-568A/B and ISO/D. Eight wires in the network cable need to be inserted in parallel into the top of the cable connector. The cable connector needs to be crimped in position. When the cable connector is in position, ensure that the metal pieces of the cable connector are parallel to each other and the clamp of the cable connector is intact.

Power Input

Bolin PTZ camera provides 24VAC power input

Power Cable

Data listed in Table 2-1 is applicable to copper cables that use 24 VAC/24 VDC power supply. The item Core Diameter indicates the conductor diameter.

Power Loss on the Cable for Different Lengths and Different Core Diameters

Distance (Unit: m)	Core Diameter (Unit: mm)			
	0.80	1.00	1.25	2.00
10	86	137	218	551
20	42	68	109	275
30	28	45	72	183
40	21	34	54	137
50	17	27	43	110
60	14	22	36	91
70	12	19	31	78

80	10	17	27	68
90	9	15	24	61
100	8	13	21	55
110	7	12	19	49
120	7	11	17	45
130	6	10	16	42
140	6	9	15	39
150	5	9	14	36
160	5	8	13	34
170	4	7	12	32
180	4	7	11	30
190	4	7	11	28
200	4	6	10	27

NOTE:

- *Important: Power supply requirement is 24VAC 2.5 Amp to ensure proper functionality of PT motor and LED illumination. Using power supply lower than 24VAC 2.5Amp will cause camera crashing or insatiability.*

Power Connector: Phoenix Connector Description

1. The anode and the cathode are not distinguished for phoenix connectors of red and black cables.
2. GND: yellow-green color.

Note: GND is used to ground the camera. Ensure that GND is connected to a reliable grounding point.

PoE Power Injector

Other than 24VAC power input, Bolin PTZ camera provides PoE power as an optional power input.

For PoE power, you must use Bolin 80W Power PoE Injector: model BL-PP80. It provides nonstandard power up to the PTZ camera. Connect this PoE injector to a network switch and then run Ethernet cable for data transmission and power up the PoE PTZ camera (Specific model: EX1000 & SD500 Series) for distance up to 100 meters.

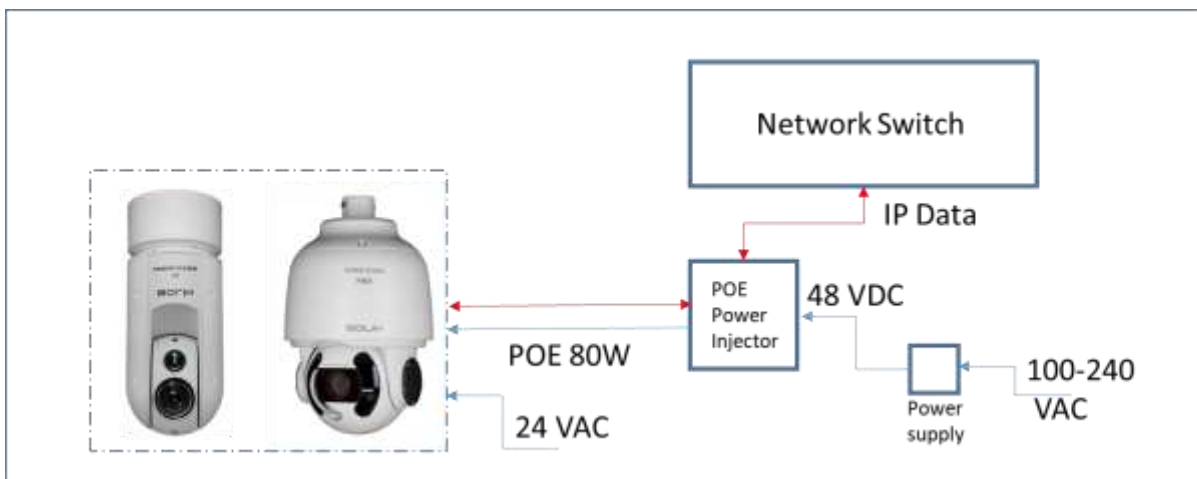

NOTE:

- *Disconnect the power from the camera before mounting.*
- *Accessories such as the wall mount bracket and the pendant mount bracket may be necessary during mounting. For their model, refer to the accessory list recommended by your dealer.*
- *The wall bearing capacity and the bracket length must meet all onsite mounting requirements. You will need to select a mount type based the actual environment.*

Mounting the Camera

NOTE:

- When mounting the camera, please install the bracket adapter to the bracket first and then mount the camera to the bracket.
- Tighten all the screws to hold the camera securely.
- For waterproofing, apply sealant between the dome and the bracket, wall veneer slits, and leading-out holes of the wall.

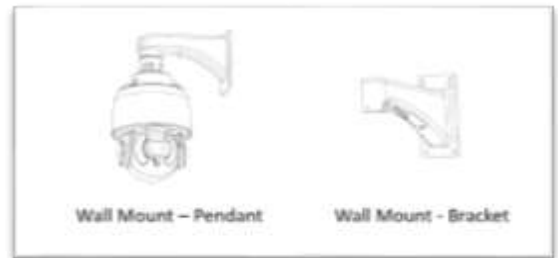

Wall Mount

1. Install the wall mount bracket. Get the heads of necessary cable (Wall cable) through the bracket from the wall outside of the bracket.
2. Pull the wall cable out through the secure ring.
3. Pull the wall cable out through the adaptor and install the secure ring and adaptor to the bracket.
4. Connect the camera tail-cable to the wall cable. Insert the cable into the bracket.
5. Install the two screws, insert the camera body head into the adaptor and turn to hang the camera.
6. Lock up the chain-locker from camera body to the secure ring.
7. Screw in the adaptor to lock the camera tight.

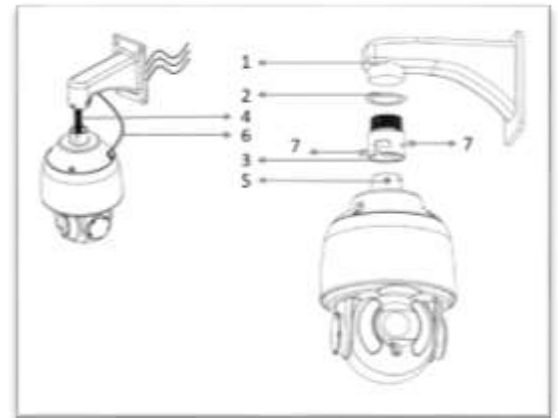

Starting the Camera

After you have mounted the camera properly, connect the camera to power.

Each time the camera is powered on, it will perform a self-test to check the Pan/Tilt/Zoom (PTZ function). After self-test, you can operate the camera.

NOTE:

- *The self-test process starts after the camera is powered up. Please wait patiently.*
- *When the operating temperature is lower than zero degrees Celsius, the camera will be automatically pre-heat (the pre-heat process takes 30 minutes at most). The self-test starts only after the temperature rises above zero degrees Celsius.*

Setting Camera over the LAN

To view and configure your camera via the local area network (LAN), you need to install the VMS (Video Management System) to access IP camera.

1. Connect your camera and your PC as shown in the figure below to ensure the routing is available.
2. Use VMS or IPC-Search-Tool to search available cameras on the network automatically.
3. Modify the camera settings if necessary, including its IP address and subnet mask.

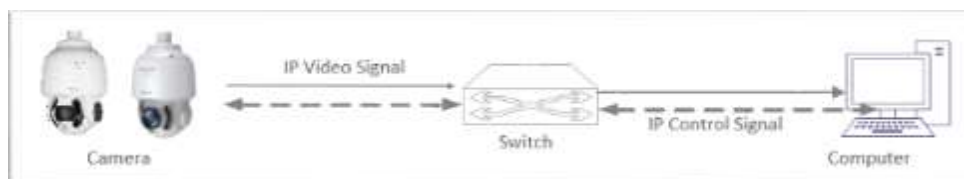

NOTE:

- *The default IP address is “192.168.0.13”. The default username is “admin”, and the default password is “admin” or “123456”.*
- *To access your camera from a different subnet, set the gateway for your camera after you log in.*

Accessing Your Camera

For camera models with IP output, you can manage and control through the web interface from a PC.

System Requirements for Your PC

1. Operating System: Microsoft Windows 8/Windows 7/Windows XP (32-bit or 64-bit). Microsoft Windows 7 (32-bit) is recommended.
2. CPU: 2.0 GHz or higher, dual-core. Intel i3 CPU or higher are recommended.
3. Memory: At least 1 GB. 2 GB (or higher) is recommended.
4. Graphic Card: At least 128 MB display memory. Mainstream discrete graphics with more than 1 GB display memory are recommended. The hardware should support DirectX9.0c. *Make sure that the latest driver is installed on graphic card.*
5. Sound Card: Essential. *The intercom and voice broadcast require the latest driver on sound card.*
6. Network Card: Gigabit Ethernet network cards (or higher) are recommended.

Accessing Your Camera

Before you begin, please check:

1. Make sure the self-test is completed.
2. Your camera is operating properly and connected to the network.
3. The PC client you are using is installed with Internet Explorer 8.0 or higher.
4. Open Internet Explorer on your PC.
5. In the address bar, input the IP address of your camera (Default IP is 192.168.0.13) and then press Enter to open the login page.
6. Enter the username (default is “admin”) and password (default is “admin” or “123456”) and then click Login.

NOTE:

- *Install the ActiveX on your first login. For detailed steps, see [Installing the ActiveX](#). When the installation of the ActiveX is completed, open IE to log in.*

Installing the ActiveX

- The following message will show in IE browser on first login. Click **Download** to install Active X.



- Click **Run**. You may also click **Save** to download the file to your computer first.
- Close the browser and follow the steps to complete the installation.

NOTE:

- *For your first login with Windows 7, if the system does not prompt you to install ActiveX, follow these steps to turn off UAC: Click the **Start** button, and then click **Control Panel**. In the search box, type **UAC**, and then click **Change User Account Control Settings**. Move the slider to the **Never Notify** position, and then click **OK**. After UAC is turned off, log in again.*
- *If the installation fails, open **Internet Option** in IE before login. Click the **Security** tab, click **Trusted sites**, and then click **Sites** to add the website. If you use Windows 7, you need to save the *setup.exe* to your PC first, and then right-click the file, select **Run as administrator**, and then install it according to instructions.*

Part Two: Network Camera User Manual

Network Connection

Before accessing a network camera (also known as IP Camera or IPC) from a PC, you need to connect the network camera to the PC directly with a network cable or via a switch or router.



Use a Shielded Twisted Pair (STP) cable to connect the network interfaces of the network camera and the PC.

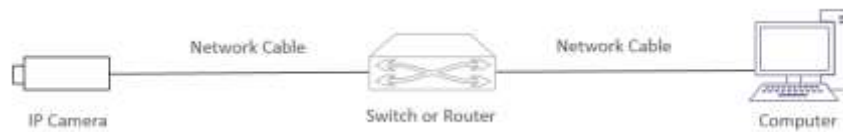

Use Shielded Twisted Pair (STP) cables to connect the network interfaces of the camera and the switch or router.

Login

Preparation

After you have completed the installation in accordance with the quick guide, connect the camera to power to start it. After the camera is started, you can access the camera from a PC client installed with a web browser or the video management software. Internet Explorer (IE) is a recommended web browser. Please contact your dealer to get the video management software. Please refer to the user manual of video management software for detailed information.

The following takes IE on a Microsoft Windows 7.0 operating system as an example.

Check before login

- The camera is operating correctly.
- The network connection between the PC and the camera is normal.
- The PC is installed with Internet Explorer 8.0 or higher.
- (Optional) The resolution is set to 1440 x 900.

Add the IP address as a trusted site

Follow the illustrations below:

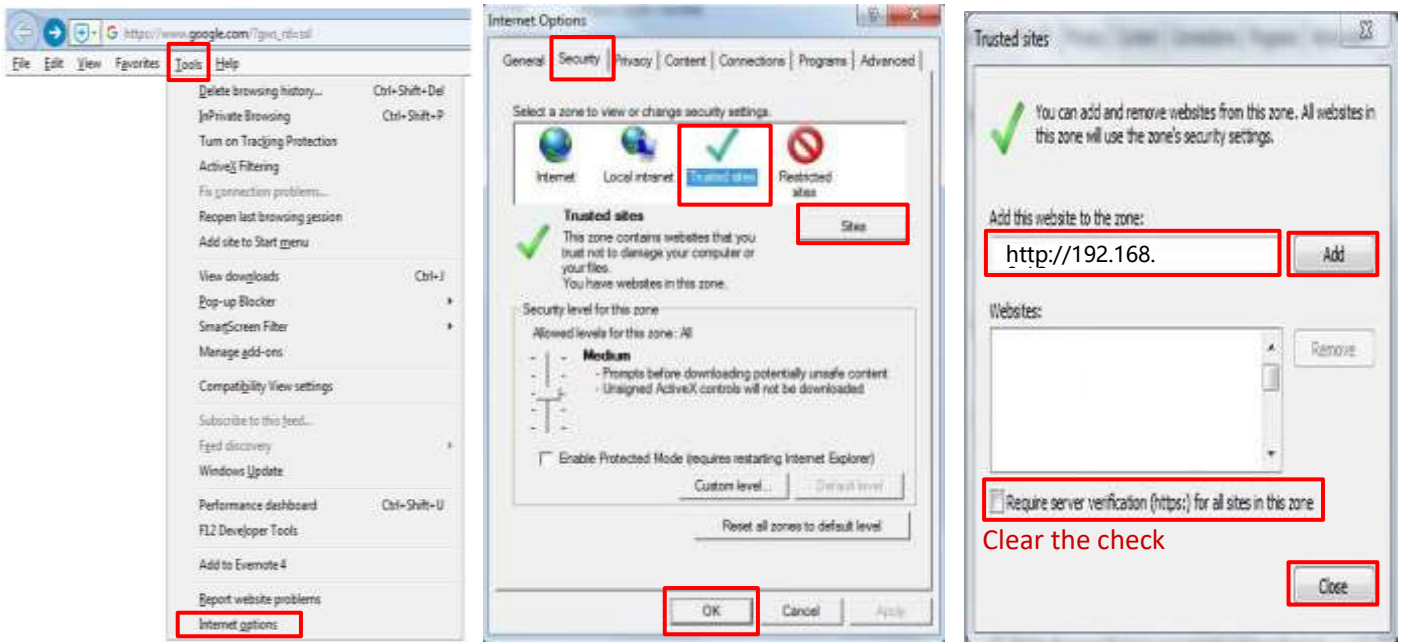

NOTE:

- The IP address 192.168.0.13 in this example is the default IP address. Please replace it with the actual address of your camera if it has been changed.

Modify user access control settings (Optional)

Before you access the camera, follow the steps to set User Account Control Settings to never notify.

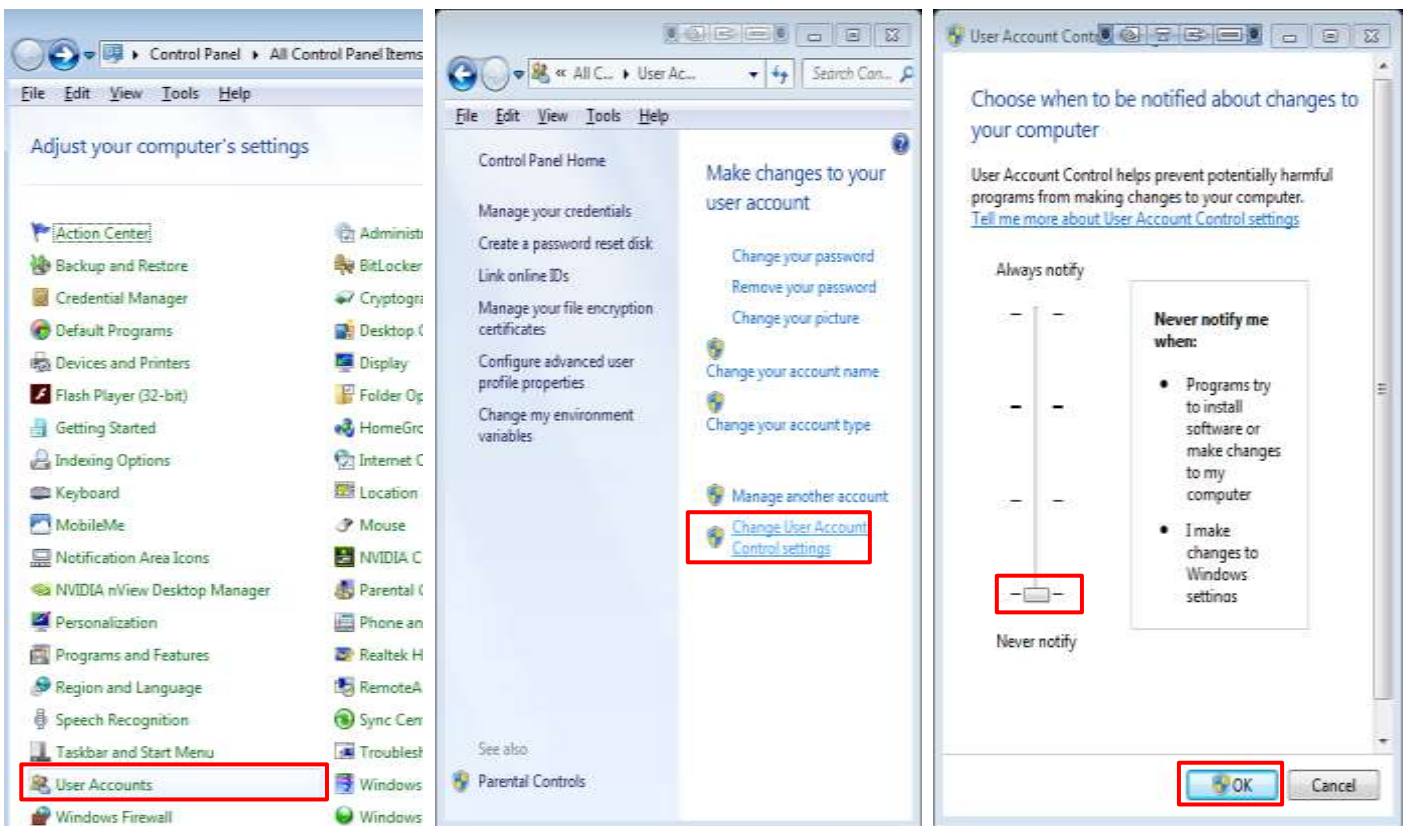

Logging In to the Web Interface

The default static IP address of the camera is 192.168.0.13, and the default subnet mask is 255.255.255.0. DHCP is turned on by default. If a DHCP server is used in the network, the IP address of your camera may be assigned dynamically, and you need to use the correct IP address to log in. Use the video management software to view the dynamic IP address of your camera.

The following takes IE as an example to describe the login procedure.

1. Browse to the login page by entering the correct IP address of your camera in the address bar.
2. If you log in for the first time, follow system prompts and install the ActiveX. You need to close your browser to complete the installation.

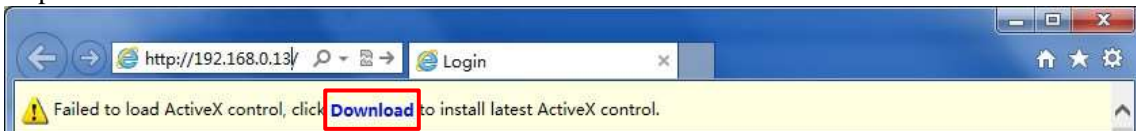

3. Click **Allow** to proceed the login process.



NOTE:

- To manually load the ActiveX, type `http://IP address/ActiveX/Setup.exe` in the address bar and press **Enter**.
- The default password is used for your first login. To ensure account security, please change the password after your first login. You are recommended to set a strong password (no less than eight characters).
- The camera protects itself from illegal access by limiting the number of failed login attempts. If login fails six times consecutively, the camera locks automatically for ten minutes.

4. Enter the username and password, and then click **Login**. For the first login, use the default username **admin** and password **123456** or **admin**.

- If you log in with **Live View** selected, live video will be displayed when you are logged in. Otherwise, you need to start live video manually in the live view window.
- If you log in with **Save Password** selected, you do not need to enter the password each time when you log in. To ensure security, you are not advised to select **Save Password**.
- To clear the **Username** and **Password** text boxes and the **Save Password** check box, click **Reset**.



NOTE:

- **Important:** Be sure to keep the new password written down and put in a safe place. If the password is forgotten, camera will require hardware resetting. Additional charges may apply for reset services.
- **Forgot Password?** If you forget the password, email the device Product Bar Code and camera's current time mm/dd/yy to support@bolintechnology.com for a temporary password. You will be able to change the password after login.

Introduction to the Web Interface

By default, the live view window is displayed when you are logged in to the Web interface. The following shows an example.

Initial Configuration

After you log in to the device, please perform the following initial configuration.

1. Set the TCP/IP address for the device: Reconfigure the device IP and network parameters based on the actual networking.
2. Log out and log in again to the Web using the new IP address.
3. Set the system time for actual situation.
4. (Optional) Setting the management server based on the actual networking.
5. Set OSD, set the information displayed on the screen as needed.
6. (Optional) Manage users. Change the default password and add common users as needed.

You can watch the live video after finishing the initial configuration. Please configure other parameters as needed.

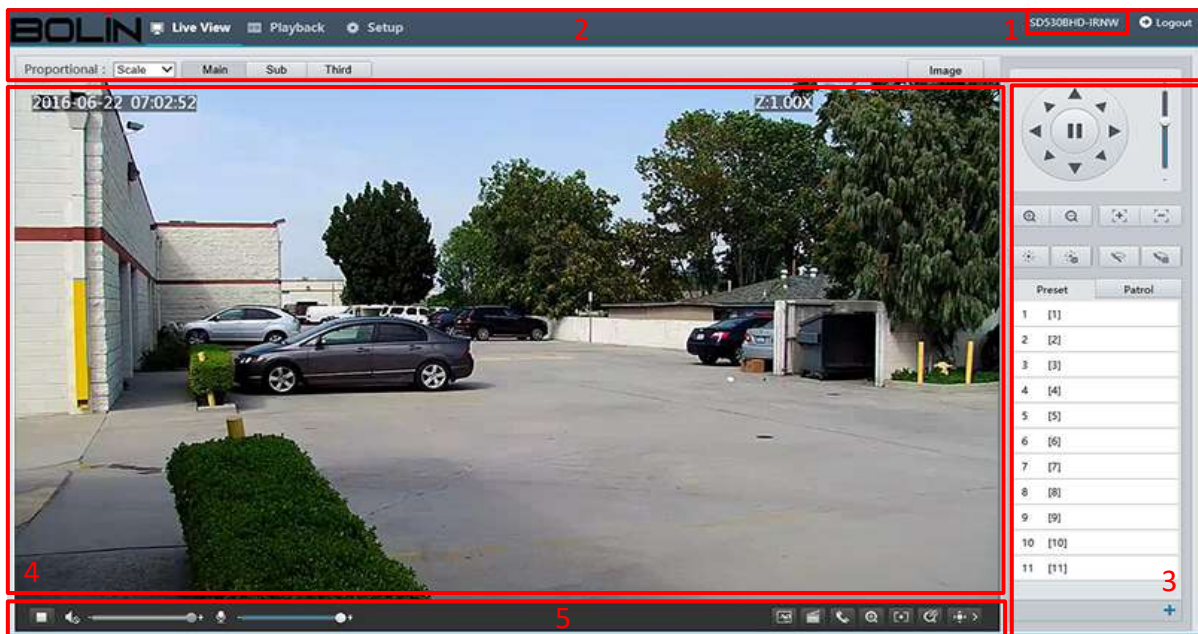

1. Model Number
2. Menu
3. PTZ control area. This area is available for PTZ dome cameras and PTZ cameras.
4. Live view window
5. Live view toolbar

NOTE:

- The displayed live view interface, parameters displayed and value ranges may vary with models. Please see the actual Web interface for details.
- The parameters that are grayed out cannot be modified. For the actual settings, see the Web interface.
- It is recommended that you change the password when you are logged in the first time. For details about
- How to change a password, see Security.

Configuring Parameters

Local Parameters

Set local parameters for your PC.

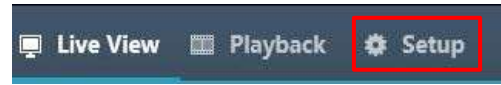

NOTE:

- The local parameters may vary with models, please see the actual Web interface for details.

Select **Setup** to go into IP camera setting up menu.

- Select **Setup > Common > Basic Info**.
It displays the basic information of the camera.
- Select **Setup > Common > Local Settings**.



3. Modify the settings as required. The following table describes some major parameters.

- Video Alarm
 - Processing Mode
 - Real Time Prior: Recommended if the network is in good condition.
 - Fluent Prior: Recommended if you want short time lag for live video.
 - Ultra-low Delay: Recommended if you want the minimum time lag for live video.
 - Video Pixel Format
 - Set the video format for images on the PC client.
It is recommended to choose **YUV420** if the graphic card of your PC supports it. **RGB32** is only supported by some low-version graphic cards.
 - Protocol
 - Set the protocol used to transmit media streams to be decoded by the PC.
- Record and Snapshot
 - Recording
 - Subsection By Time: Duration of recorded video for each recording file on the computer. For

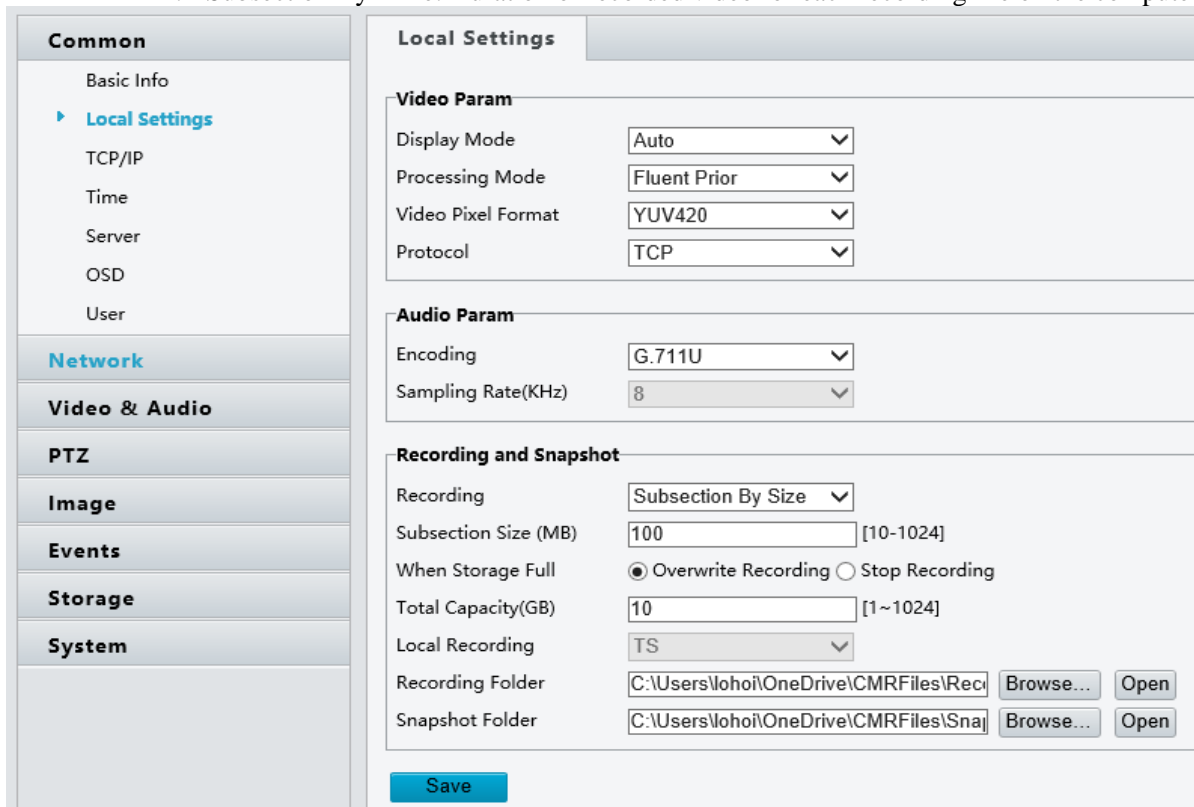

- example, 2 minutes.
 - ii. Subsection By Size: Size of each recording file stored on the computer. For example, 5M.
 - b. When Storage Full
 - i. Overwrite Recording: When the assigned storage space on the computer is used up, the camera deletes the existing recording files to make room for the new recording file.
 - ii. Stop Recording: When the assigned storage space on the computer is full, recording stops automatically.
4. Click **Save**.

Network Configuration

TCP/IP

Modify communication settings such as the IP address for the camera so that the camera can communicate with other devices.

NOTE:

- After you have changed the IP address, you need to use the new IP address to log in.
- The configurations of DNS (Domain Name System) server are applicable when the device is accessed by domain name.

1. Click **Setup > Network > TCP/IP**.
2. Select **Static IP** from the **IP Obtain Mode** drop-down list.
3. Enter the IP address, subnet mask, and default gateway address. Make sure that the IP address of the camera is unique in the network.
4. Click **Save**.

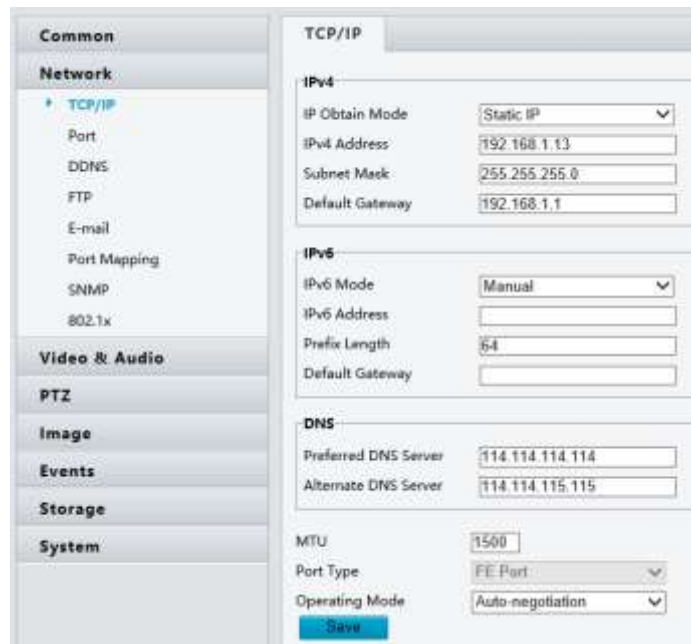

If a gatekeeper or firewall is used in the network, Universal Network Passport (UNP) can be used to interconnect the network, and the UNP server will assign an IP address to the connected cameras.

1. Select **Enable** for UNP Service.
2. In the **UNP Server IP** text box, enter an IP address for the UNP server. Select **Yes** to enable authentication, and then set the username and password for UNP authentication.
3. Click **Save**.

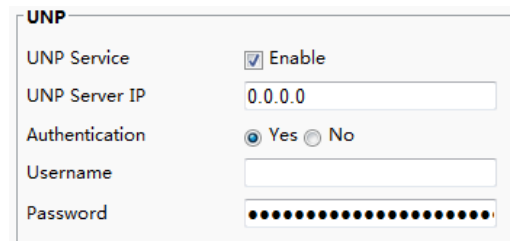

NOTE:

- This function is not supported by some models, please see the actual model for details.

PPPoE

If the camera is connected to the network through Point to Point over Ethernet (PPPoE), you need to select PPPoE as the IP obtainment mode.

1. Click **Setup > Network > TCP/IP**.
2. Select **PPPoE** from the **IP Obtain Mode** drop-down list.
3. Enter the username and password provided by your internet Service Provider (ISP).
4. Click **Save**.

NOTE:

- *This function is not supported by some models, please see the actual model for details.*

The screenshot shows the network configuration page with the following settings:

- IPv4**: IP Obtain Mode: PPPoE, Username: user, Password: [masked]
- IPv6**: IPv6 Mode: Manual, IPv6 Address: [empty], Prefix Length: 64, Default Gateway: [empty]
- DNS**: Preferred DNS Server: 114.114.114.114, Alternate DNS Server: 114.114.115.115
- MTU**: 1500
- Port Type**: FE Port
- Operating Mode**: Auto-negotiation
- Save** button is visible at the bottom.

DHCP

The Dynamic Host Configuration Protocol (DHCP) is enabled by default when the camera is delivered. If a DHCP server is deployed in the network, the camera can automatically obtain an IP address from the DHCP server.

To manually configure DHCP, follow the steps below:

1. Click **Setup > Network > TCP/IP**.
2. Select **DHCP** from the **IP Obtain Mode** drop-down list.
3. Click **Save**.

The screenshot shows the network configuration page with the following settings:

- IPv4**: IP Obtain Mode: DHCP
- IPv6**: IPv6 Mode: Manual, IPv6 Address: [empty], Prefix Length: 64, Default Gateway: [empty]
- DNS**: Preferred DNS Server: 114.114.114.114, Alternate DNS Server: 114.114.115.115
- MTU**: 1500
- Port Type**: FE Port
- Operating Mode**: Auto-negotiation
- Save** button is visible at the bottom.

Port

1. Click **Setup > Network > Port**.
2. Configure relevant port numbers.
3. Click **Save**.

The screenshot shows the Port configuration page with the following settings:

- HTTP Port**: 80
- HTTPS Port**: 443
- RTSP Port**: 554
- Note**: Modifying the RTSP or server port number will cause the device to restart.
- Save** button is visible at the bottom.

NOTE:

- *This function is not supported by some models, please see the actual model for details.*
- *If the entered HTTP port number has been occupied, a prompt message will be displayed as Port conflicts. Please try again. 23, 81, 82, 85, 3260 and 49152 are occupied by default. And other occupied ports will be detected automatically.*

FTP

After the configuration of FTP, you will be able to upload snapshots from network cameras to the specified FTP server.

1. Click **Setup > Network > FTP**.
2. Configure the IP address, port number of the FTP server, the username and password of the upload account, enable **Upload Images** and **Overwrite Storage**, and then set the overwrite image threshold.
3. Click **Save**.

E-Mail

After the configuration of E-mail, when alarms are triggered, you will be able to send messages to the specified E-mail address.

1. Click **Setup > Network > E-mail**.
2. Configure relevant parameters of the sender and the recipient.

The following table describes some major parameters.

- A. SSL
 - a. When enabled, the e-mail will be sent through SSL encryption.
- B. Attach Image
 - a. When enabled, the e-mail will contain 3 instant snapshots as attachment according to the Capture Interval.

3. Click **Save**.

Port Mapping

1. Click **Setup > Network > Port Mapping**.
2. Enable **Port Mapping** and select mapping type. If **Manual** is selected, then external ports must be configured (external IP is obtained automatically by the camera). If the configured port is occupied, then the **Status** will show Inactive.
3. Click **Save**.

Port Type	External Port	External IP	Status
HTTP	80000	0.0.0.0	Inactive
RTSP	80554	0.0.0.0	Inactive
Server	80001	0.0.0.0	Inactive

DDNS

1. Click **Setup > Network > DDNS**.
2. Enable **DDNS Service**.
3. Click **Save**.

NOTE:

- This function is not supported by some models, please see the actual model for details.

Image Configuration

Image Adjustment

NOTE:

- The image parameters displayed and value ranges allowed may vary with camera model. For the actual parameters and value ranges of your camera, see the Web interface. You may move the sliders to adjust settings or enter values in the text boxes directly.
- Clicking **Default** will restore all the default image settings.

1. Click **Setup > Image > Image**.
See the Image Adjustment page as bellow:

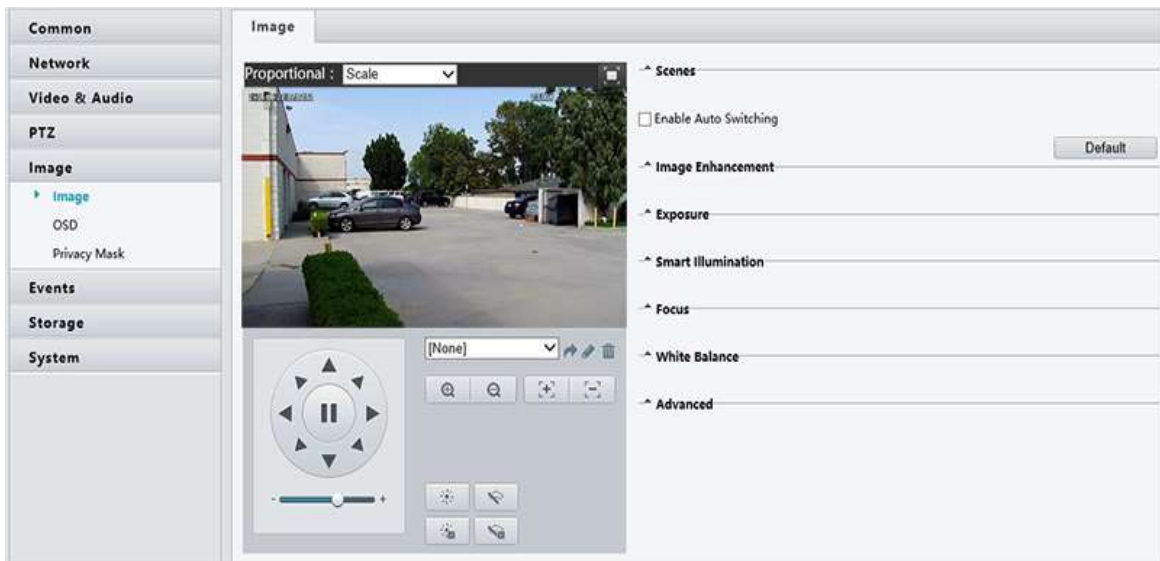

Setting the Scene

Set image parameters to achieve the desired image effects based on live video in different scenes.

Click **Setup > Image > Image**.

Click **Scenes**.

The scene management page for some models is displayed as follows (Right Top), you can select the desired scene in the drop-down list.

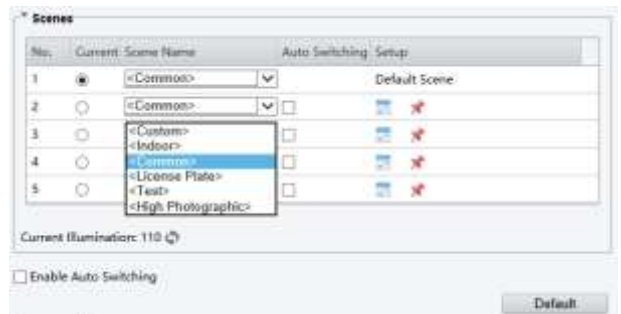

The Web interface of certain models is displayed as follows (Right Below).

No.	Current	Scene Name	Auto Switching	Setup
1	<input checked="" type="radio"/>	<Standard>	<input type="checkbox"/>	Default Scene
2	<input type="radio"/>	<Bright>	<input type="checkbox"/>	<input type="checkbox"/> <input type="checkbox"/>
3	<input type="radio"/>	<Vivid>	<input type="checkbox"/>	<input type="checkbox"/> <input type="checkbox"/>
4	<input type="radio"/>	<Standard>	<input type="checkbox"/>	<input type="checkbox"/> <input type="checkbox"/>
5	<input type="radio"/>	<Standard>	<input type="checkbox"/>	<input type="checkbox"/> <input type="checkbox"/>

1. Click **Scenes**.
2. Select a scene, and then set scene switching parameters. The following table describes some major parameters.

A. Current

- a. Indicates the scene that is being used.
 - i. Select an option button to switch to the scene and display the corresponding image

parameters for the scene.

- ii. The camera switches the current scene automatically when **Enable Auto Switching** is selected.



B. Scene Name

- a. Name of the current scene. The device provides several preset scene modes. When you select a scene, the corresponding image parameters are displayed. You can adjust image settings according to actual needs.
 - i. Common: recommended for outdoor scenes
 - ii. Indoor: recommended for indoor scenes
 - iii. License Plate: recommended for plate snapshot on roads
 - iv. High Sensitivity: recommended for scenes with low light
 - v. Highlight Suppression: recommended for scenes with intense light, for example, it is used to reduce the car light to snapshot the license plate
 - vi. WDR: recommended for scenes with high-contrast lighting, such as window, corridor, front door or other scenes that are bright outside but dim inside
 - vii. Custom: set a scene name as needed
 - viii. Standard: default image settings
 - ix. Vivid: increase the saturation of the image based on the standard mode.
 - x. Bright: increase the brightness of the image based on the standard mode.

C. Auto Switching

- a. Indicates whether to add a scene to the auto-switching list.
 - i. If **Auto Switching** is selected, the system switches to a scene automatically when the condition for switching to the scene is met. By default, the auto-switching list includes the default scene.

D. Setup

- a. Click  to set conditions for auto-switching, including schedule, illumination, and current elevation (angle between the PTZ and the horizontal direction). It means that auto-switching is triggered only when illumination and the current elevation during the set time period meet the set conditions. A condition is invalid if both the start and end values are set to 0.
3. Select a scene and then click  to set it as the default scene.
4. If auto-switching is enabled, the camera can switch to the scene automatically when the condition for switching to a non-default scene is met. Otherwise, the camera remains in the default scene. When auto-switching is not enabled, the camera remains in the current scene.

NOTE:

- *If Auto Switching is enabled (scene settings will be unavailable), the device will switch between the set scenes. If not, the device will stay at the current scene. The device will stay at default scenes unless the non-default scenes are triggered.*
- *If multiple non-default scenes are triggered, then the device will switch to the scene with the minimum*
- *Number (starts from 1 to 5).*

Image Enhancement

NOTE:

- *This function is not supported by some models, please see the actual model for details.*

1. Click **Setup > Image > Image** and then click **Image Enhancement**.
2. Use the sliders to change the settings. You may also enter values directly. The following table describes some major parameters.



- A. Brightness
 - a. Set the degree of brightness of images.
- B. Saturation
 - a. The amount of a hue contained in a color.
- C. Contrast
 - a. Set the degree of difference between the blackest pixel and the whitest pixel.
- D. Hue
 - a. Overall tendency of colors in an image.
- E. Sharpness
 - a. Contrast of boundaries of objects in an image.
- F. 2D Noise Reduction
 - a. Reduce the noise of images. The function may cause image blurring.
- G. 3D Noise Reduction
 - a. Reduce the noise of images. The function may cause motion blur (or ghosting in some applications).
- H. Image Rotation
 - a. Rotation of the image



3. To restore default settings in this area, click **Default**.

Exposure

NOTE:

- *This function is not supported by some models, please see the actual model for details.*
- The default settings are used for common scenes. Keep the default settings unless a particular scene is required.

1. Click **Setup > Image > Image** and then click **Exposure**.
2. Set the parameters as required. The following table describes some major parameters.

- A. Shutter (s)
 - a. Shutter is used to control the light that comes into the lens. A fast shutter speed is ideal for scenes in quick motion. A slow shutter speed is ideal for scenes that change slowly.
 - i. You can set a shutter speed when **Exposure Mode** is set to **Manual** or **Shutter Priority**.
 - ii. If **Slow Shutter** is set to **Off**, the reciprocal of the shutter speed must be greater than the frame rate.
- B. Gain (dB)
 - a. Control image signals so that the camera outputs standard video signals according to the light condition.
 - i. You can set this parameter only when **Exposure Mode** is set to **Manual** or **Gain Priority**.
- C. Slow Shutter
 - a. Improves image brightness in low light conditions.

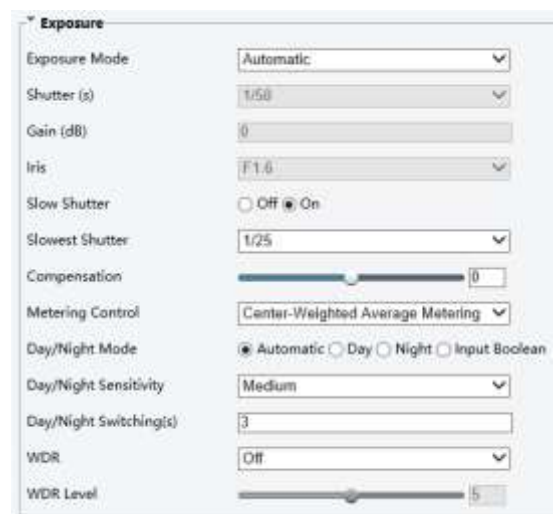

- i. You can set this parameter only when **Exposure Mode** is not set to **Shutter Priority** and when **Image Stabilizer** is disabled.
- D. Slowest Shutter
 - a. Set the slowest shutter speed that the camera can use during exposure.
 - i. You can set this parameter only when **Slow Shutter** is set to **On**.
- E. Compensation
 - a. Adjust the compensation value as required to achieve the desired effects.
 - i. You can set this parameter only when **Exposure Mode** is not set to **Manual**.
- F. Metering Control
 - a. Set the way the camera measures the intensity of light.
 - i. Center-Weighted Average Metering: Measure light mainly in the central part of images.
 - ii. Evaluative Metering: Measure light in the customized area of images.
 - iii. Highlight compensation: Ignore the brightness of the overexposed area of images. But selecting this setting will decrease the overall brightness of the image.
 - iv. You can set this parameter only when **Exposure Mode** is not set to **Manual**.
- G. Day/Night Mode
 - a. Automatic: The camera outputs the optimum images according to the light condition. In this mode, the camera can switch between night mode and daymode automatically.
 - b. Night: The camera provides high-quality black and white images using the existing light
 - c. Day: The camera provides high-quality color images using the existing light.
 - d. Input Boolean: The camera switches between day mode and night mode based on the alarm input.
- H. Day/Night Sensitivity
 - a. Light threshold for switching between day mode and night mode. A higher sensitivity means that the camera is more sensitive to the change of light and becomes more easily to switch between day mode and night mode.
 - i. You can set this parameter only when **Day/Night Mode** is set to **Automatic**.
- I. Day/Night Switching(s)
 - a. Set the length of time before the camera switches between day mode and night mode after the conditions for switching are met.
 - i. You can set this parameter only when **Day/Night Mode** is set to **Automatic**.
- J. WDR
 - a. Enable WDR to distinguish the bright and dark areas in the same image.
 - i. You can set this parameter only when **Exposure Mode** is set to **Automatic**, **Indoor 50Hz**, **Indoor 60Hz** and when **Image Stabilizer** and **Defog** is disabled.
- K. WDR Level
 - a. After enabling the WDR function, you can improve the image by adjusting the WDR level.
 - i. Use level 7 or higher when there is a high contrast between the bright and dark areas of the scene. In the case of low contrast, it is recommended to disable WDR or use level 1-6.

3. To restore the default settings, click Default.

Smart Illumination

NOTE:

- *This function is not supported by some models, please see the actual model for details.*

1. Click **Setup > Image > Image** and then click **Smart Illumination**.

The Web interface of certain box camera model is displayed as follows. Select the corresponding lightning type and then

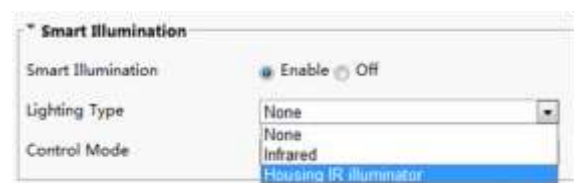

configure other parameters.

The Web interface of certain network camera model is displayed as follows. Follow steps below to configure the illumination parameters.

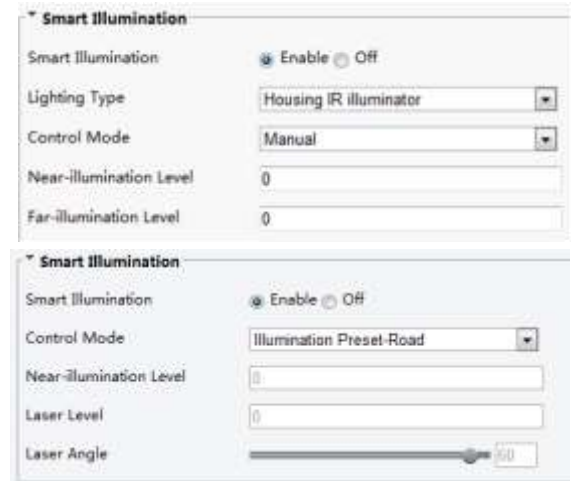

2. Select the correct IR control mode and set the parameters. The following table describes some major parameters.

A. Control Mode

- a. **Global Mode:** The camera adjusts IR illumination and exposure to achieve balanced image effects. Some areas might be overexposed if you select this option. This option is recommended if monitored range and image brightness are your first priority.
- b. **Overexposure Restrain:** The camera adjusts IR illumination and exposure to avoid regional overexposure. Some areas might be dark if you select this option. This option is recommended if clarity of the central part of the image and overexposure control are your first priority.
- c. **Illumination Preset-Road:** This mode offers strong illumination in whole and is recommended for monitoring wide-ranging scenes, for example, road.
- d. **Illumination Preset-Park:** This mode offers uniform light and is recommended for monitoring small range scenes with many obstacles, for example, industrial parks.
- e. **Manual:** This mode allows you to manually control the intensity of IR illumination.
- f. **Indoor:** This mode is recommended for application in indoor scenes.

B. Illumination Level

- a. Set the intensity level of the IR light. The greater the value, the higher the intensity. 0 means that the IR light is turned off.
 - i. You can set this parameter only when **Control Mode** is set to **Manual**.
 - ii. You are recommended to set this parameter first for a wide-angle scene.
 - iii. You are recommended to set this parameter first if the scene requires an intermediate focal length.
 - iv. You are recommended to set this parameter first if the scene requires a telephotoview.

3. To restore the default settings, click **Default**.

Focus

NOTE:

- *This function is not supported by some models, please see the actual model for details.*

- 1. Click **Setup > Image > Image** and then click **Focus**.
- 2. Select the focus mode as required.

A. Focus Mode

- a. **Auto Focus:** The camera focuses automatically according to the current light condition.

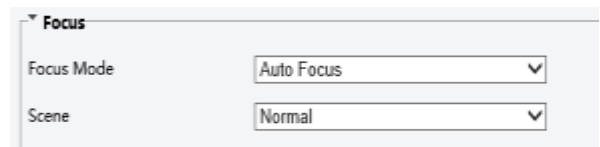

- b. Manual Focus: Manually adjust camera focus as required.
- c. One-Click Trigger: The camera is triggered to focus once when rotating, zooming or going to a preset.
- d. One-Click Trigger (IR): In a low light condition such as during night hours or in a dark house, this focus mode achieves better effects with the IR light turned on.

B. Scene

- a. Normal: Used for common scenes, such as road and industrial park.
- b. Long Distance: Used for long-distance monitoring on a road. For example, when the camera is installed over 30 meters high to monitor a distant road intersection.

3. To restore the default settings, click **Default**.

White Balance

White balance is the process of offsetting unnatural color cast in images under different color temperatures so as to output images that best suit human eyes.

NOTE:

- *This function is not supported by some models, please see the actual model for details.*

1. Click **Setup > Image > Image** and then click **White Balance**.
2. Select a white balance mode as required. The following table describes some major parameters.



A. White Balance: Adjust the red or blue offset of the image:

- a. Auto: The camera adjusts the red and blue offset automatically according to the light condition (the color tends to be blue).
- b. Fine Tune: Allow you to adjust the red and blue offset manually.
- c. Sodium Lamp: The camera adjusts red and blue offset automatically according to the light condition (the color tends to be red).
- d. Outdoor: It is recommended for the outdoor scenes with a wide range of the color temperature variation
- e. Locked: Lock the current color temperature settings without adjustment.

B. Red Offset

- a. Adjust the red offset manually.
 - i. You can set this parameter only when **White Balance** is set to **Fine Tune**.

C. Blue Offset

- a. Adjust the blue offset manually.
 - i. You can set this parameter only when **White Balance** is set to **Fine Tune**.

3. To restore the default settings, click **Default**.

Defog

Use the defog function to adjust the clarity of images captured in fog or haze conditions.

NOTE:

- *This function can be configured only when WDR is disabled.*

1. Click **Setup > Image > Image** and then click **Advanced**.
2. Enable the defog function and then select a level for the scene. Level 5 achieves the maximum defog effects, and level 1 achieves the minimum.
3. To restore the default settings, click **Default**.

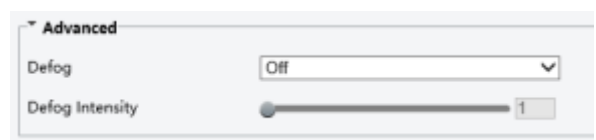

Configuring Iris and Lens

NOTE:

- This function is only supported by certain network box camera types, please see the actual model for details.
- When using the lens with P-Iris control mode that supports Z/F function, connect the iris control cable to the Z/F port of the camera. When using the lens with DC-Iris control mode that does not support Z/F function, connect the iris control cable to the IRIS port of the camera.

1. Click **Setup > Image > Image** and then click **Advanced**.
2. Modify the settings as required. The following table describes some major parameters.



D. Lens Mode

- a. Z/F: to modify focus and zoom.
- b. P-Iris: to modify iris value.
- c. DC-IRIS: the maximum iris value by default.

E. Aperture Control

- a. Automatically or manually adjust iris.
 - i. You can set this parameter only when **Lens Mode** is set to **P-Iris**.

3. To restore the default settings, click **Default**.

OSD Settings

On Screen Display (OSD) is the text displayed on the screen with video images and may include time and other customized contents.

NOTE:

- This function may vary with models, please see the actual Web interface for details.

1. Click **Setup > Image > OSD**. See the OSD page as follow:

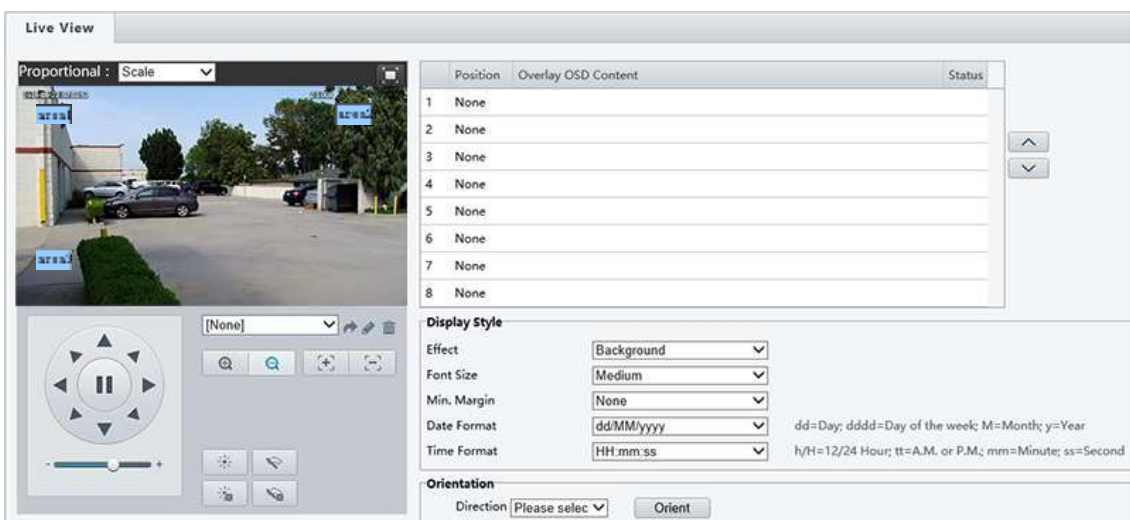

2. Select the check box, the content of the OSD and then set the position to display it.

- **Position:** Click the desired box in the **Live View** area. After the cursor shape is changed, click and hold the button to move the box to the desired position. To set the position precisely, use the X and Y coordinates under **Overlay Area**.
- **Overlay OSD Content:** The drop-down list provides **Time**, **Preset** and **Serial Info**. You may also select **Custom** and enter the content you want.
- After you have set the position and OSD content, the ✓ symbol appears in the **Status** column, which means that the OSD is set successfully. You may set multiple lines of contents for each area and use ^ and v to adjust the sequence of display.

Position	Overlay OSD Content	Status
1 Area1	<Date & Time>	✓
2 Area2	<Zoom>	✓
3 None		
4 None		
5 None		
6 None		
7 None		
8 None		

3. After you have completed the settings, a message appears to indicate the successful settings.

You may right-click in the preview window and then choose to view in full screen mode or at an aspect ratio.

You may also double-click the preview window to enter or exit full screen mode.

To cancel OSD for an area, clear the OSD content in the **Overlay OSD Content** column or select **None** in the

Position column.

The right picture shows an example of Data &Time / Zoom OSD.



Privacy Mask

On certain occasions, you may need to set a mask area on the camera image to protect privacy, for example, the keyboard of an ATM machine. When PTZ changes its position or zooms, the Privacy Mask will be adjusted accordingly to protect the area all along.

NOTE:

- *This function may vary with models, please see the actual Web interface for details.*

1. Click **Setup > Image > Privacy Mask**.
2. Click **Add** to add a privacy mask, and click **Delete** to delete a mask.
 - To mask a position: Click the box (with **Mask** displayed on it) to activate the mask. After the cursor shape has changed, drag the box to the intended position.
 - To mask an area: Use the mouse to draw a box on the area you want to mask.
 - When privacy mask is configured, the intended area is blocked. The following shows an example.

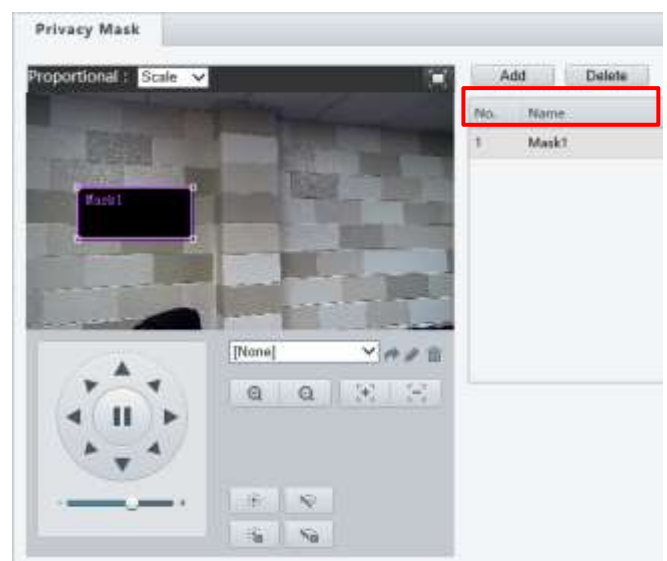

Audio and Video Configuration

Video Configuration

You can set video parameters that your camera supports and view the current status of BNC output. If available, you may also enable sub-stream and third stream as required.

NOTE:

- This function may vary with models. Only some camera models support the third stream. To determine if your camera supports this function, see the Web interface.
- After enabling the sub or third stream, modify the parameters as required. The parameters for the sub and third stream have the same meanings as that for the main stream.

1. Click **Setup > Video & Audio > Video**.
2. Modify the settings as required. The following table describes some major parameters.

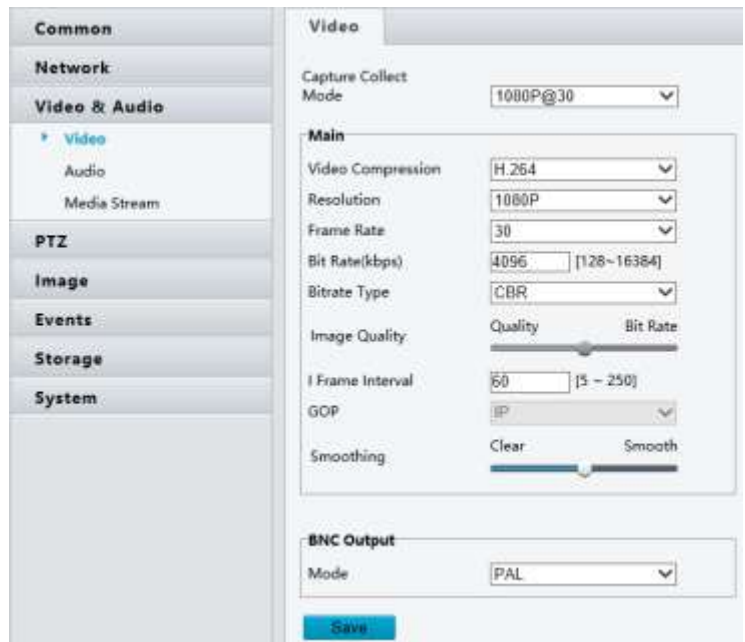

A. Bitrate Type

- a. CBR: Constant Bit Rate, which means that the camera transmits data at a constant data rate.
- b. VBR: Variable Bit Rate, which means that the camera adjusts the bit rate dynamically according to image quality.

B. Frame Rate

- a. Frame rate for encoding images. Unit: FPS (frame per second).
 - i. To ensure image quality, note that the frame rate should not be greater than the reciprocal of shutter speed.

C. Image Quality

- a. When **Encoding Mode** is **VBR**, you can move the slider to adjust quality level for images. Moving the slider toward **Bit Rate** decreases the bit rate and may affect image quality. Moving the slider toward **Quality** increases the bit rate and improves image quality.

D. Smoothing

- a. Set the extent of smoothing. Choosing **Clear** means disabling **Smoothing**. Moving the slider toward **Smooth** increases the level of smoothing but will affect image quality.
 - i. In a poor network environment, you can enable smoothing to get more fluent video.

E. BNC Output

- a. BNC output supports NTSC and PAL.

3. Click **Save**.

Video Format

1. You can select the video format from **Capture Collect Mode** dropdown menu.
2. The selection of the video format is different on HD, 3MP, 4K resolution models.

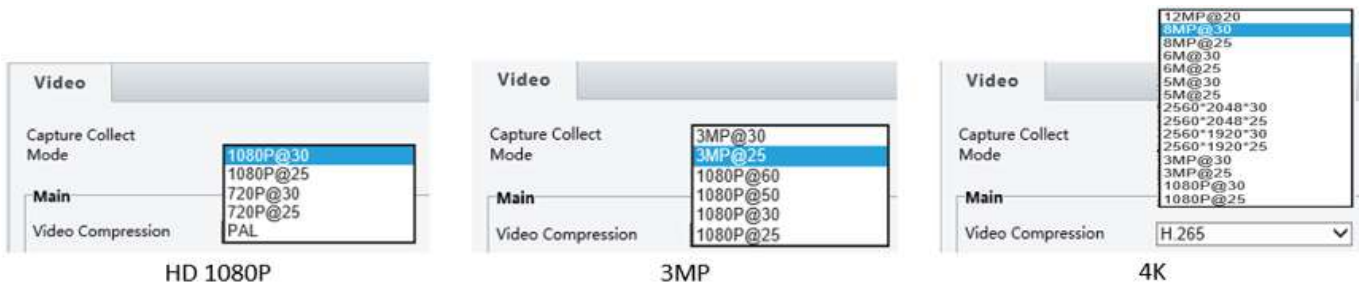

3. Click **Save** after you make the selection.

NOTE:

- Changing the video format/capture mode will restore the default encoding setting and causes the device to restart. It takes a little while for the camera to finish the rebooting.
- The screen will be frozen during the camera rebooting. The camera image or setting page will come back automatically or you may need to click **Video** or **Live View** again to retrieve the page and video.

Video Compression

1. You can select the video format from **Video Compression** dropdown menu.
2. The selection of the Video compression is different on HD, 3MP, 4K resolution models.

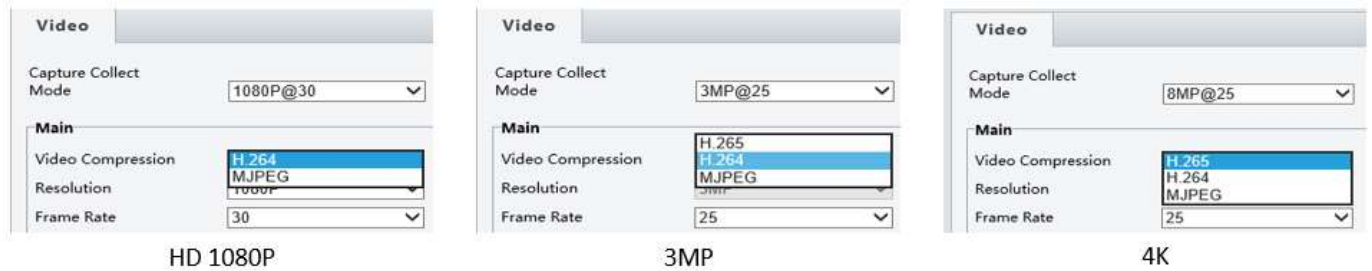

3. Click **Save** after you make the selection.

Audio Configuration

Audio configuration means setting audio encoding parameters for your camera.

NOTE:

- This function may vary with models, please see the actual Web interface for details.

1. Click **Setup > Video & Audio > Audio**.
2. Modify the settings as required. The following table describes some major parameters.

F. Audio Input

- a. No audio data will be encoded when Off is selected.
 - i. It is recommended to select Off if you do not need audio. This can improve device performance to some extent.

G. Input Gain

- a. Audio signal amplification for sampling. The greater the gain, the greater amplification.

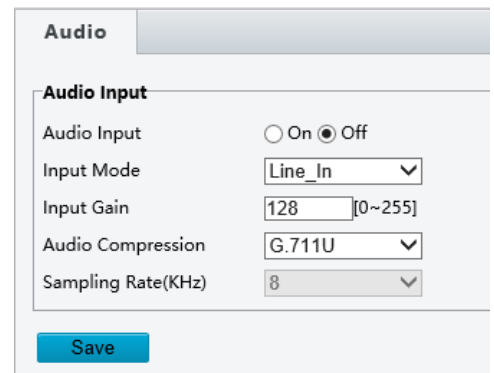

3. Click **Save**.

ROI

When Region of Interest (ROI) is enabled, the system ensures image quality for ROI first if the bit rate is insufficient.

NOTE:

- *This function may vary with models, please see the actual Web interface for details.*

1. Click **Setup > Video & Audio > ROI**.
2. To enable ROI, select the check box, and then use the mouse to draw an area that covers the object you want to mask.

Media Stream Configuration

NOTE:

- *This function may vary with models, please see the actual Web interface for details.*

Media Stream

You can display the established media streams from a camera. You may also set the camera so it transmits code streams by the UDP or TCP protocol to a specified IP address and port number. The settings can be saved and take effect after the camera is restarted.

1. Click **Setup > Video & Audio > Media Stream**.
2. Click +, select a stream type, and then set the IP address and port number of the unicast or multicast group for the decoding device that receives audio and video streams from the camera. If you want the device to establish the media stream that has been configured before automatically after the restart, select **Yes** for **Persistent**.
3. To delete a stream, click .
4. Click **Submit** to complete the operations.



RTSP URL are as following:

- **Main Steam:** `rtsp://username:password@IP:port/media/video1`
- **Sub:** `rtsp://username:password@IP:port/media/video2`
- **Third:** `rtsp://username:password@IP:port/media/video3`

Note: We recommend that you can use VCL or FFMPEG Media Player as they will often be faster and include audio support.

RTSP Multicast Address

After an RTSP multicast address is configured, the third-party player can request the RTSP multicast media stream from the camera through the RTP protocol.

1. Click **Setup > Video & Audio > Media Stream > RTSP Multicast Address**.
2. Set the multicast address (224.0.0.0 to 239.255.255.255) and port number (0 to 65535).
3. Click **Save**.

The screenshot shows a web interface for configuring RTSP Multicast Address. It features two tabs: 'Media Stream' and 'RTSP Multicast Address'. The 'RTSP Multicast Address' tab is active. The interface is divided into three sections: 'Main', 'Sub', and 'Third'. Each section contains two input fields: 'Multicast Address' and 'Port'. The 'Main' section has 'Multicast Address' set to '0.0.0.0' and 'Port' set to '0'. The 'Sub' section has 'Multicast Address' set to '0.0.0.0' and 'Port' set to '0'. The 'Third' section has 'Multicast Address' set to '0.0.0.0' and 'Port' set to '0'. A 'Save' button is located at the bottom of the form.

Alarm Configuration

NOTE:

- *This function may vary with models, please see the actual Web interface for details.*
- *The alarm triggered actions supported by the camera may vary with models, please see the actual Web interface for details.*

You can schedule alarm reporting and set actions that can be triggered by other devices so that alarms and the triggered actions can be handled in time.

Alarm reporting can be scheduled for motion detection alarm, alarm input, alarm output, tampering detection alarm, and audio detection alarm. The supported alarms may vary with device model. For the alarm types that your camera supports, see the Web interface.



Configuring Motion Detection Alarm

Motion Detection

Motion detection detects the object motion in a specified rectangular area during a period. You need to set a detection area, sensitivity of detection, object size, and history for the camera to decide whether to report a motion detection alarm when it detects motion.

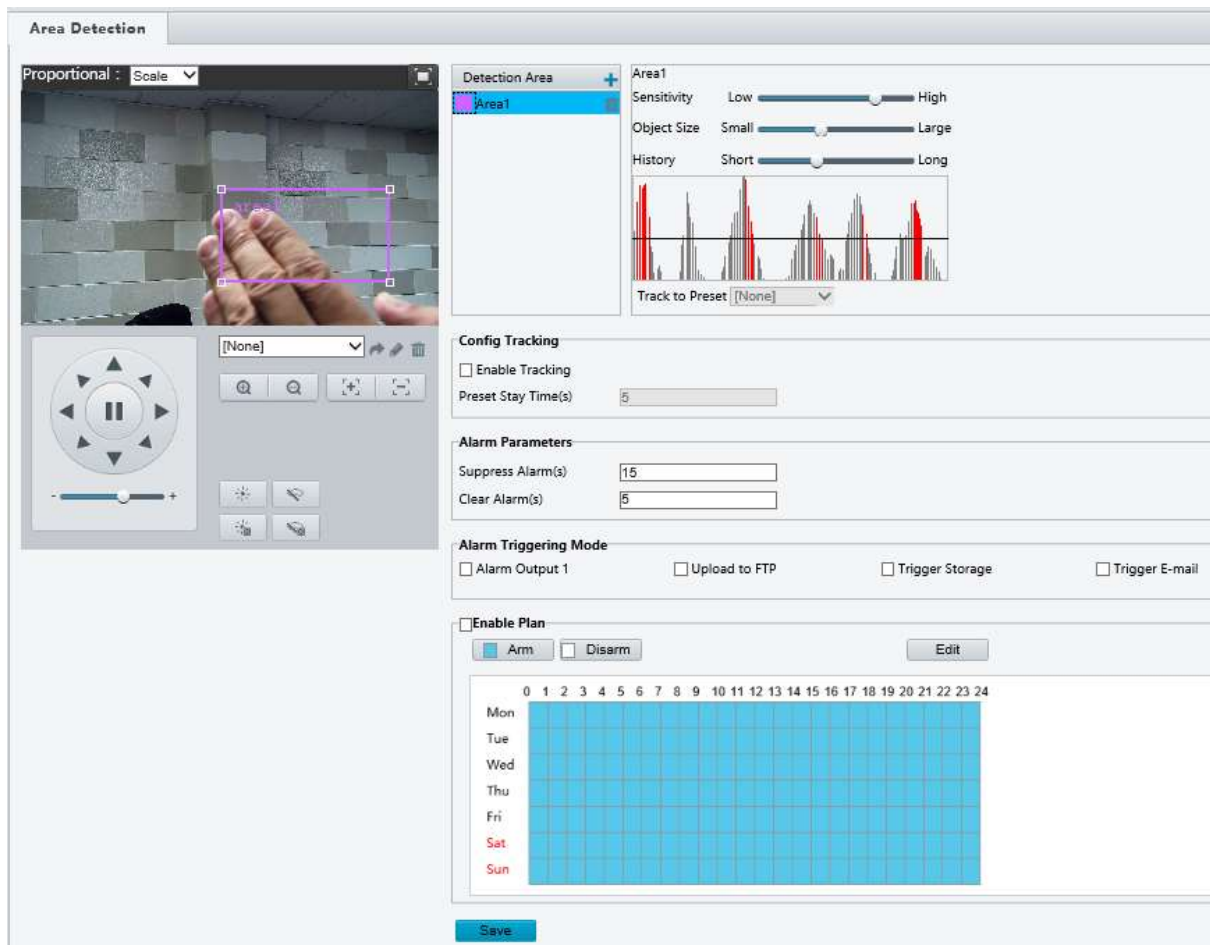
1. Click **Setup > Events > Common Alarm > Motion Detection**.



2. In the Detection Area, click  to add a new detection area. To delete a detection area, click .
3. Click and drag the mouse to set a detection area.
4. Set the detection sensitivity, object size, and history for the camera to decide whether to report a motion detection alarm.
 - a. Moving the slider to the right increases detection sensitivity. When the extent of motion within the detection area exceeds the set object size, and if the duration of motion exceeds the set duration, the camera reports an alarm.
 - b. Motion detection results are shown in real time. The red lines represent the raised motion detection alarms. The longer a line, the greater the extent of motion. The denser the lines, the greater the frequency of motion.
5. Set the alarm parameters.
 - a. Suppress Alarm(s): After an alarm is triggered, the same alarm will not be reported within the set time.
 - b. Clear Alarm(s): After an alarm is triggered,
 - i. If the same alarm is not triggered within the set time, the alarm will be cleared and the same alarm can be reported again.
 - ii. If the same alarm is triggered within the set time, the alarm will not be cleared until the suppress alarm time expires. Then the same alarm can be reported again.
6. Set actions to be triggered by motion detection alarm and the plan.
 - a. The following table describes the major alarm-triggered actions and how to set a plan.
 - b. Alarm Output 1
 - i. Select the check box. This setting is the alarm output interface linked to motion detection alarm.
 1. When an alarm is reported, the camera triggers alarm output so as to trigger actions by

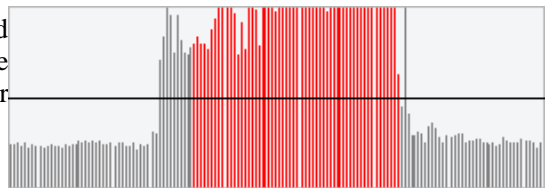

a third-party device.

- c. PTZ to Preset
 - i. Select the check box and set the preset linked to motion detection alarm.
 - 1. Make sure you have set presets. Otherwise, you cannot set this parameter. For details about how to set a preset, [see Setting Presets.](#)
 - 2. When an alarm is reported, the PTZ camera automatically goes to the preset to capture video in the correct scene.
- d. Upload to FTP
 - i. With **Upload to FTP** selected, the camera will automatically upload snapshots to the specified FTP server when an alarm is triggered.
 - 1. Make sure you have completed [FTP](#) and [Configuring Capture](#) before using this function.
- e. Trigger E-mail
 - i. With **Trigger E-mail** selected, the camera will automatically send snapshots to the specified E-mail address when an alarm is triggered.
 - 1. Make sure you have completed [E-Mail](#) and [Configuring Capture](#) before using this function.
- f. Trigger Storage
 - i. With **Trigger Storage** enabled, the camera automatically starts recording after an alarm is triggered.
 - 1. Make sure you have completed the post-recording time settings before using this function.
- g. Enable Plan
 - i. Select the check box and set the start and end times during which motion detection alarm is effective. You can directly drag the mouse to draw a plan and click **Edit** to edit time periods in the table. The time periods cannot overlap. The camera reports alarms during the specified period(s) only.
 - ii. You can select from Monday to Sunday and set four periods for each day.
 - iii. Plan drawing using a mouse is only supported by IE versions later than 8.0. After setting the plan for one day, you can apply the same settings to other days by clicking **Copy** and **Paste**.

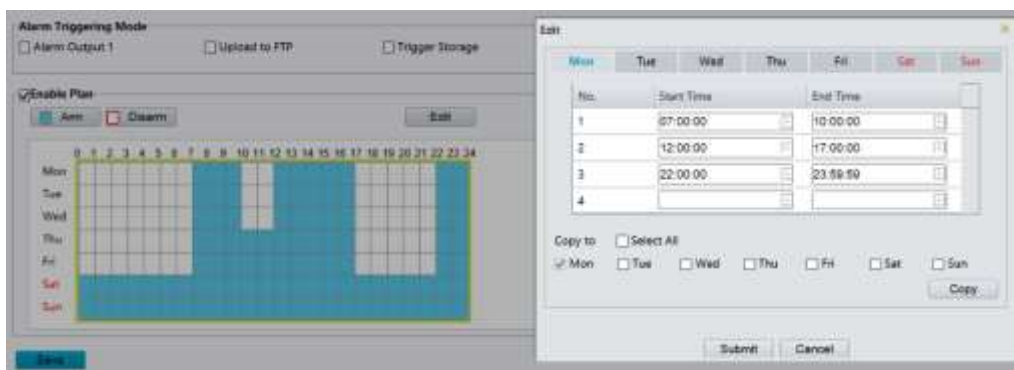

- iv. Drag the mouse to draw a plan and Edit time periods in the table.

7. Click **Save**.

Configuring Audio Detection Alarm

The camera can detect input audio signals for exceptions. When the rise or fall of volume exceeds the set limit, or when the input volume reaches the threshold, the camera reports an alarm and triggers the set actions. Make sure that an audio input device is correctly connected to the camera and audio input is turned on in [Configuring Alarm Input](#).

1. Click **Setup > Events > Common Alarm > Audio Detection**.

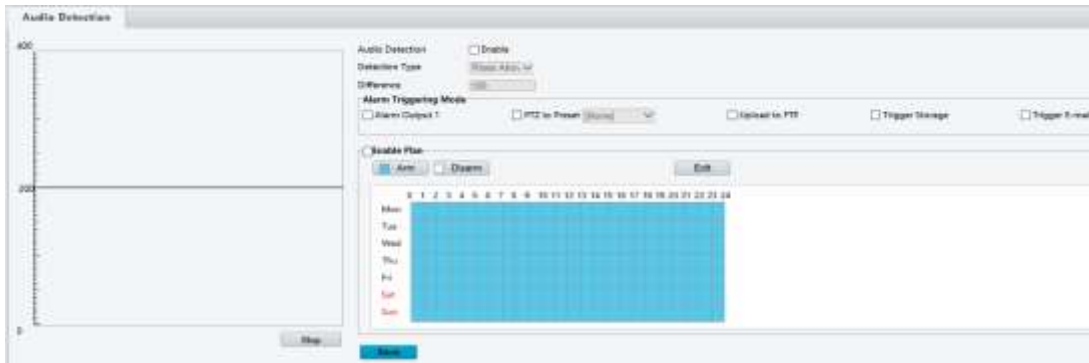

2. Select **Enable** for **Audio Detection**, select a detection type and set the difference or threshold. To disable audio detection, clear the **Enable** check box. The following table describes some major parameters.

a. Detection Type

- i. Rise Above: An alarm is reported when the rise of volume exceeds the difference.
- ii. Falls Below: An alarm is reported when the fall of volume exceeds the difference.
- iii. Passes: An alarm is reported when the rise or fall of volume exceeds the difference.
- iv. Threshold: An alarm is reported when the volume exceeds a threshold.

b. Threshold/ Difference

- i. Threshold: After a volume is set as the threshold, an alarm is reported when the threshold is exceeded.
- ii. Difference: the difference between two volumes. When the rise or fall of volume exceeds the difference, an alarm is reported.

1. The scale in the audio detection area is used to measure sound volume.

2. Audio detection results are shown in real time. The red part indicates that the volume of the audio alarm has reached the threshold and the alarm does not necessarily report.

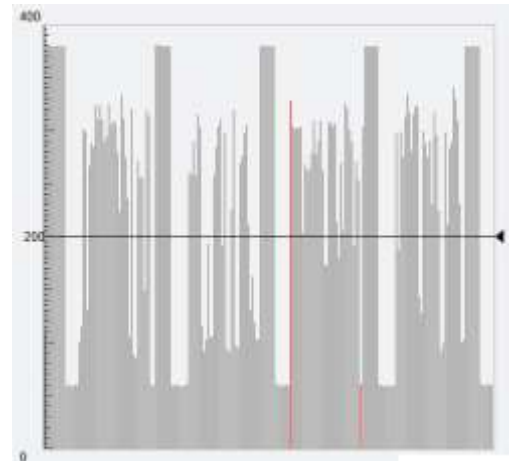

3. Set the alarm-triggered actions and arming schedule as required. For the detailed steps, see the descriptions of alarm-triggered actions in [Configuring Motion Detection Alarm](#).

4. Click **Save**.

Configuring Alarm Input

The camera can receive alarm information from a third-party device. To use this function, you need to configure the following information for alarm input first: port, alarm name, alarm type (normally open or normally closed) and alarm reporting time.

1. Click **Setup > Events > Alarm Input**.
2. Select the Boolean and set the Boolean name.
3. Select **Normally Open** or **Normally Closed** according to the type of the third-party alarm input device. For example, if the third-party alarm input device is normally open, you need to select **Normally Open**

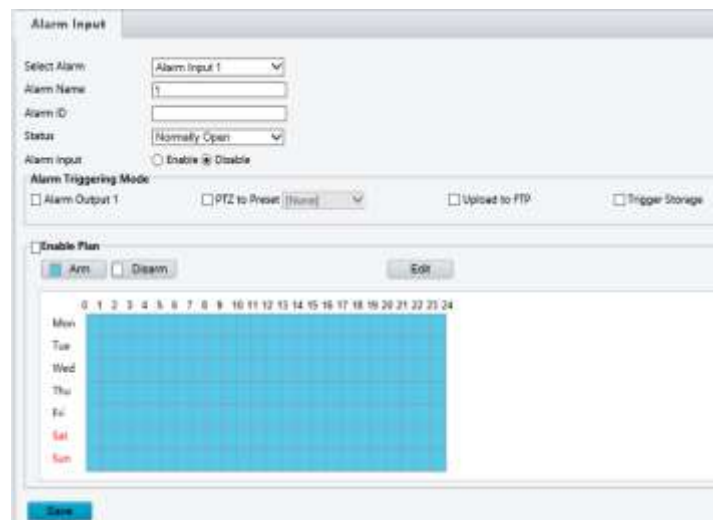

here, so that the camera can receive alarm information from the third-party alarm input device.

4. Set actions to be triggered by an input alarm and the plan. For the detailed steps, see the descriptions of alarm-triggered actions in [Configuring Motion Detection Alarm](#).
5. Click **Save**.

Configuring Alarm Output

After alarm output is triggered by a motion detection alarm, temperature alarm or Boolean alarm, the camera can output alarm information to the third-party device if alarm output is set correctly to Normally Open or Normally Closed. The alarm output duration is configurable.

1. Click **Setup > Events > Alarm Output**.
2. Select the alarm and set the alarm name. Set the status to **Normally Open** (default setting) and set the alarm duration.
3. Click **Save**.

Select Alarm	Alarm Output 1
Alarm Name	2
Status	Normally Open
Delay(s)	5

CAUTION:

Strictly follow the sequence when powering on the devices to avoid damaging camera components:

- Check that the alarm type is set to Normally Open (default setting), and that the camera and the alarm output device are powered off.
- After completing the connection, power on the alarm output device first and then power on the camera.

Configuring Capture

With the function of capture configured, when an alarm is triggered, the camera will automatically upload the captured snapshots to the FTP server or send snapshots the specified email address.

1. Click **Setup > Events > Capture**.
2. Enable **Capture**, and configure relevant parameters.
3. Click **Save**.

Capture	<input type="checkbox"/> Enable
Resolution	1920*1080
Image Quality	Medium
Capture Interval(s)	1
Number to Capture	1
Scheduled Snapshot	
Mode	<input type="radio"/> Timed <input checked="" type="radio"/> Continued
Interval(s)	60

Memory Card Storage

NOTE:

- This function is not supported by some models, and may vary with models, please see the actual model for details.
- Memory storage is recommended when the camera operates in stand-alone mode.

Memory card storage is used to save videos and snapshots to the memory card directly.

Manual storage

The camera records live video repeatedly if manual storage is enabled.

1. Click **Setup > Storage > Storage**.

2. Enable memory card storage and modify the settings as required. The following table describes some major parameters.

- a. Storage Medium

- i. Storage resource type.

1. To format the memory card, disable the storage function for the card first. Then Click **Format** and then click **OK** to confirm the operation. The system will restart when the format is completed.

2. Information about the total and free space is displayed.

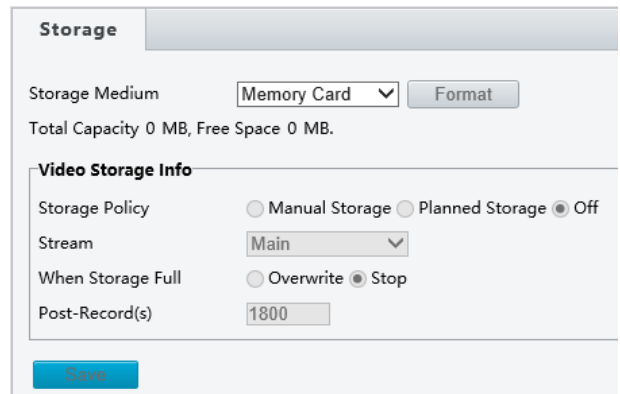

- b. When Storage Full

- i. Overwrite: If there is no free space in the memory card, new data will overwrite the existing data repeatedly.
 - ii. Stop: If there is no free space in the memory card, new data will not be saved to the memory card.

- c. Post-Record(s)

- i. When an alarm is raised, the camera is triggered to record live video and continues recording for a set post-record time after the alarm is cleared.

3. Click **Save**.

Planned storage

If planned storage is enabled, the camera records video to the memory card during the specified periods.

1. Click **Setup > Storage > Storage**.
2. Select **Planned Storage**, and then set the periods during which the camera records video to the memory card.
3. Click **Save**.

NOTE:

- To play recordings in the memory card, see *Video Playback and Download with Edge Storage*.



System Maintenance

NOTE:

- This function is not supported by some models, and may vary with models, please see the actual model for details.

Security

User Management

There are two types of users in the system:

- Administrator: referred to as “admin” in this manual. The default name of the administrator is admin, which cannot be modified. Admin has full permission and can manage all users and devices. Only one admin user is allowed in the system.
- Common user: referred to as “user” in this manual. User only has permission to play live and recorded video. Up to 31 common users are allowed in the system.

You can add a user on the user management interface (under **Setup > System > Security**).

After the user is added successfully, you can change the password by entering the new password or delete the user by clearing the username.

NOTE:

- Only admin can change passwords. Changing the username or password for a user when the user is still logged in will force the user to log out. The user must use the new username or password to log in.
- Only admin can add and delete users. Deleting a user when the user is still logged in will force the user to log out. A deleted user cannot log in.

Setting Secure Data Transmission

Set a secure channel for data transmission to ensure security.

1. Click **Setup > Network > Port**.
2. Enter the port number in the **HTTPS Port** text box and then click **Save**.
3. Click **Setup > System > Security**. Under **HTTPS**, select **Enable**. Uploading a custom SSL certificate is also supported to ensure security.
4. Click **Save**.

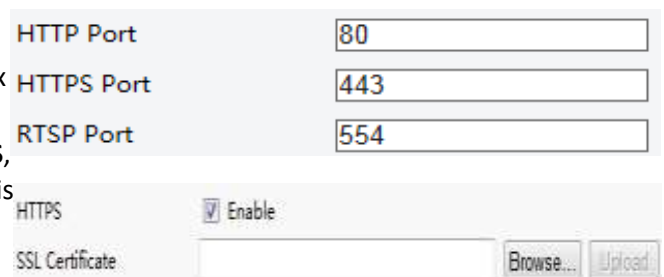

Next time you log in, enter the address in *https://IP:HTTPS port number* format, for example, <https://192.168.0.13:443>, to enter secure channel mode. If HTTPS uses a default port number, enter the address in <https://IP> directly.

RTSP Authentication

RTSP (Real Time Streaming Protocol) is an application layer protocol. To transmit and control the audio and video, set RTSP authentication on the Web interface.

1. Click **Setup > System > Security > RTSP Authentication**.
2. Select an authentication mode (basic/digest) and then click **Save**.

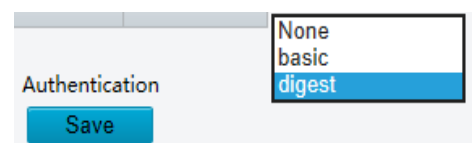

Hide Vendor Information

You can set to hide the vendor information of the network camera on the Web interface.

1. Click **Setup > System > Security**.
2. Under **Registration Info**, select **Enable**.

ARP Binding

This function can protect the camera from ARP attacks. When the camera visits an IP of another network segment via a gateway, it can communicate only with the MAC address binding to the gateway address in the same segment.

1. Click **Setup > System > Security > ARP Binding**.
2. Select the check box to enable the ARP binding function and set the MAC address.
3. Click **Save**.



ARP Binding Enable
Gateway Address 192.168.0.1
MAC Address 11:22:33:44:55:77
Save

IP Address Filtering

You can allow or deny the access from the specified IP address to your camera.

1. Click **Setup > System > Security > IP Address Filtering**.
2. Select **Enable**. Select the filtering mode and then enter the desired IP addresses.
3. Click **Save**.

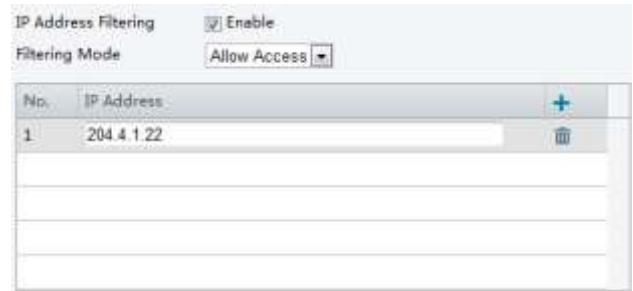

IP Address Filtering Enable
Filtering Mode Allow Access
No. IP Address
1 204.4.1.22
+
-

NOTE:

- If the filtering mode is set to **Allow Access**, only the specified IP addresses are allowed to access the camera. If the filtering mode is set to **Deny Access**, the specified IP addresses are denied for the access.
- Up to 32 IP addresses are allowed. And the added IP addresses cannot duplicate.
- The first byte of the IP address can only be a number ranging from 1 to 223 and the fourth byte cannot be 0. For example, 0.0.0.0, 127.0.0.1, 255.255.255.255 and 224.0.0.1 all are invalid IP addresses.

Video Watermark

You can set the video watermark for the camera to encrypt the video and protect it from being deleted or modified.

1. Click **Setup > System > Security > Video Watermark**.
2. Select **Enable** and set the watermark content.
3. Click **Save**.

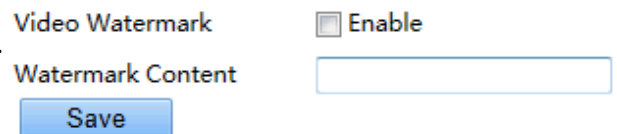

Video Watermark Enable
Watermark Content
Save

Setting the System Time

You can use the following methods to adjust the system time of your device.

Manually Setting or Synchronizing the System Time

1. Click **Setup > Common > Time**, and then click the **Time** tab.
2. Select **Enable** for **Client Time Synchronization**.
3. Set the correct time zone and system time.
You may also click **Sync with Computer Time** to synchronize the time settings of your camera with that of your PC.
4. Click **Save**.

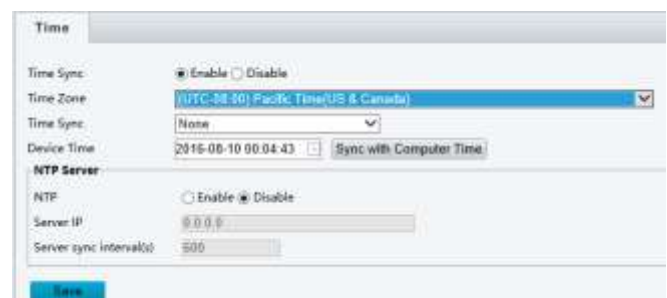

Time
Time Sync: Enable Disable
Time Zone: (UTC-08:00) Pacific Time (US & Canada)
Time Sync: None
Device Time: 2016-08-10 00:04:43 Sync with Computer Time
NTP Server
NTP: Enable Disable
Server IP: 0.0.0.0
Server sync interval(s): 300
Save

Synchronizing with the NTP Server

1. Click **Setup > Common > Time**, and then click the **Time** tab.

2. Select **Enable** for **NTP**, and then enter the IP address of the NTP server and the camera's sync interval with the NTP server.
3. Click **Save**. The camera will periodically synchronize time with the NTP server.

Setting Servers

If the camera is managed by a central server, you need to configure the server related parameters.

CAUTION:

- *This function is not supported by some models, please see the actual model for details.*
- *If the device ID, protocol or server IP is changed, the camera will restart, and the login password for admin and the system time will be updated as the settings on the central management server. In addition, all settings, except the following, will be restored to factory defaults: network interface card, server, image, OSD, privacy mask, custom information, and ROI.*
- *Registration will fail if the device ID is different from that stored on the central management server. You need to restart the camera in order for the registration to succeed.*
- *If the camera operates independently, select **None** for **Protocol**.*

Connect via the Private protocol

1. Click **Setup > Common > Server**, and then click the **Management Server** tab.
2. In the **Device ID** text box, enter an ID that is unique in the network.
3. Select **Private** from the **Protocol** drop-down list.
4. Enter the correct IP address and port number for the central management server.
5. Click **Save**.



Serial Port Mode Configuration

The RS485 serial port is used for data exchange with the third-party device. Serial port settings on the camera should be consistent with that of the connected third-party device.

NOTE:

- *This function is not supported by some models, please see the actual model for details.*
- *The actual displayed Web interface may vary with the device model.*

PTZ control

To control a PTZ camera through a third-party device, you need to set **Port Mode** to **PTZ Control**.

By sending PELCO-D compliant PTZ control commands through the RS485 port, you can control the PTZ camera without using the PTZ control panel.

1. Click Setup > System > Ports & Devices, and then click the Serial Port tab.
2. Select PTZ Control from the Port Mode drop-down list. The following table describes some major parameters.

- a. PTZ Protocol

- i. Set the PTZ protocol that the channel supports.

1. You can set this parameter only when **Port Mode** is set to **PTZ Control**.

2. When **PTZ Protocol** is set to **INTERNAL-PTZ**, the camera can connect to the external PTZ without using the serial port (serial port parameters are grayed out). In this case, you only need to connect the zoom and focus interfaces of the camera to the lens, and then you can operate the PTZ like an internal PTZ.

- b. PTZ Mode

- i. Built-in PTZ Priority: When this option is selected, the camera first tries to control the PTZ (for example, to zoom or focus) by itself instead of through the external PTZ. For operations that the camera cannot accomplish by itself, the camera uses the external PTZ.
- ii. External PTZ Priority: The camera first tries to control the PTZ through the PTZ connected through the serial port.

1. You can set this parameter only when **Port Mode** is set to **PTZControl**.
2. When **INTERNAL-PTZ** is selected, this parameter is always set to **Built-in PTZ Priority**, and it is unnecessary to connect the camera to an external PTZ through the serial port. Control through the external PTZ is not effective even when the camera has been connected to an external PTZ.
3. Set this parameter as required. Make sure PTZ control related interfaces are correctly connected.

- c. Address Code

- i. Set the address code for the PTZ.

1. You can set this parameter only when **Port Mode** is set to **PTZ Control** and **PTZ Protocol** is not set to **INTERNAL-PTZ**.

- d. Click **Save**.

The screenshot shows the configuration page for RS485_1. The 'Port Mode' is set to 'PTZ Control'. Other settings include Baud Rate: 9600, Data Bits: 8, Stop Bits: 1, Parity: None, Flow Control: None, PTZ Protocol: INTERNAL-PTZ, PTZ Mode: Built-in PTZ Priority, and Address Code: 1. The 'Enable Trans-Channel' checkbox is unchecked.

Transparent channel

Use the RS485 serial port to achieve transparent data transmission with the third-party device.

1. Click Setup > System > Ports & Devices, and then click the Serial Port tab.

2. Select **Trans-Channel** from the **Port Mode** drop-down list.

3. Click **Save**.

The screenshot shows the configuration page for RS485_1. The 'Port Mode' is set to 'Trans-Channel'. Other settings include Baud Rate: 9600, Data Bits: 8, Stop Bits: 1, Parity: None, Flow Control: None. The 'Enable Trans-Channel' checkbox is unchecked.

OSD

To display information from the third-party device on the OSD, you need to select OSD as the port mode. The camera receives information from the third-party device through the RS485 serial port, translates the received information, and then displays it on the OSD.

NOTE:

To enable the camera to correctly translate information received from the third-party device, make sure that the information sent by the third-party device through the serial port complies with the data format specified by our company. For more details, contact your dealer.

1. Click **Setup > System > Ports & Devices**, and then click the **Serial Port** tab.
2. Select **OSD** from the **Port Mode** drop-down list and select **Enable OSD Report**. Then OSD data will be reported to the management platform.
3. Click **Save**.

The screenshot shows the configuration page for RS485_1. The 'Port Mode' is set to 'OSD'. The 'Enable OSD Report' checkbox is checked. Other settings include Baud Rate: 9600, Data Bits: 8, Stop Bits: 1, Parity: None, and Flow Control: None. At the bottom, there is an unchecked checkbox for 'Enable Trans-Channel'.

Transparent Channel Configuration

Transparent channel is mainly used to achieve transparent data transmission between two devices.

NOTE:

- This function is not supported by some models, please see the actual model for details.
- Make sure that you have set **Port Mode** to **Trans-Channel** for your camera.
- The actual displayed Web interface may vary with the device model.

1. Click **Setup > System > Ports & Devices**, and then click the **Trans-Channel** tab.
2. Select **Enable** for **Trans-Channel**.
3. Enter the destination IP address and port number (IP address and port number that the transparent channel connects to).
4. Click **Save**.

The screenshot shows the configuration page for RS485_1 with 'Trans-Channel' selected. The 'Enable Trans-Channel' checkbox is checked. Below this, there are input fields for Destination IP (192.168.0.30), Destination Port (17081), Source IP (204.4.1.234), and Source Port (1025).

Wiper Control

You can set the wiper parameters to control the housing and the PTZ wiper operation.

1. Click **Setup > System > Ports & Devices**, and then click the **External Device** tab.
2. Set the wiper control mode and the parameters to enable wiper.

The screenshot shows the 'Wiper' configuration section. The 'Control Mode' is set to 'Serial Port'. The 'Enable Wiper' checkbox is checked, and the mode is set to 'Normally Open'.

NOTE:

- *Serial Port: The wiper is controlled through PELCO-D instructions. Please set the PTZ protocol to PELCO-D.*
- *Normally Open/Closed: The wiper is controlled through alarm input/output settings, including normally open and normally closed.*
- *Enable Wiper: This function is available only in alarm input/output mode.*

Viewing Device Status

You can view the current status of your camera.

1. Click **Setup > Common > Navigation**.
2. Click **Refresh** for the latest status information.
3. View the device information.

Maintenance

Upgrading the Device

If the device is managed by the central management server and you want to upgrade the devices in batch mode, it is recommended to perform the upgrade operation on the central server. For detailed steps, see the user manual for the central management server.

1. Click **Setup > System > Maintenance**.



2. Under **Firmware Upgrade**, click **Browse** and select the correct upgrade file.
3. (Optional) Select the check box to enable **Upgrade Boot Program**.
4. Click **Upgrade** and then confirm to start. The camera will restart automatically after the upgrade is completed.

NOTE:

- *You must use the correct upgrade file for your camera. Otherwise, unexpected results may occur.*
- *The upgrade file is a ZIP file and must include all the necessary files.*
- *The boot program loads the operating system and then the system starts running. The upgrade boot program function is disabled by default, and only the camera will be upgraded to the latest version. If enabled, both the camera and the boot program are upgraded, and the operating system of the following new versions can be booted properly and the camera can be upgraded conveniently.*
- *Ensure that the power supply is normal during upgrade. The device will restart after the upgrade is completed.*

Restarting the System

1. Click **Setup > System > Maintenance**.

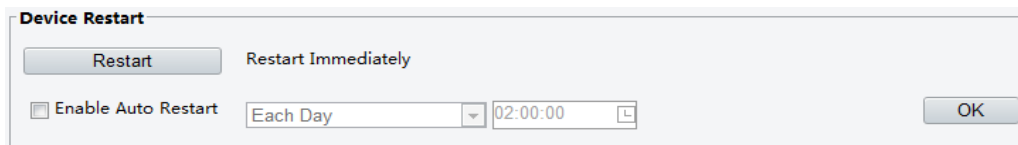

2. Under **Device Restart**, click **Restart**. The device will restart after you confirm the operation. You may also enable auto-restart by selecting **Enable Auto Restart** and setting a time for auto-start. The device will restart at the set time.
3. Perform this operation with caution because restarting the system interrupts the ongoing service.

Importing and Exporting System Configuration File

Export the current configurations of the camera and save them to the PC or an external storage medium. You can also quickly restore configurations by importing backup configurations stored on the PC or an external storage medium back to the camera.

CAUTION:

- After you perform the Default operation, all settings are restored to factory defaults, except the following: login password of the system administrator, network settings, and system time.
- Make sure you import the correct configuration file for your camera. Otherwise, unexpected results may occur.
- The camera will restart when the configuration file is imported successfully.

1. Click **Setup > System > Maintenance**.

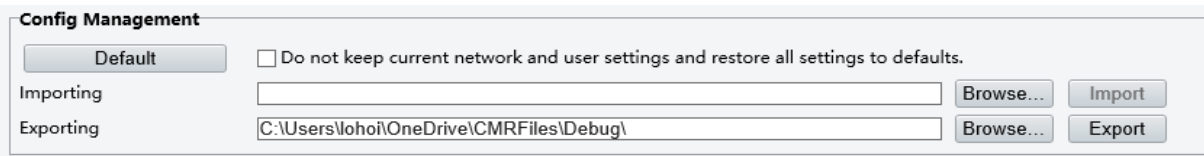

Config Management

Do not keep current network and user settings and restore all settings to defaults.

Importing

Exporting

2. To import configurations that you have backed up, click **Browse** next to the **Import** button and select the configurations you want to import, and then click **Import**. The result will be displayed.
3. To export configurations, click **Browse** next to the **Export** button, select the destination folder, and then click **Export**.
4. To restore default configurations, click **Default** and then confirm the operation. The device will restart and restore the default configurations.

Collecting Diagnostic Information

Diagnostic information includes logs and system configurations. You can export diagnostic information to your PC.

1. Click **Setup > System > Maintenance**.

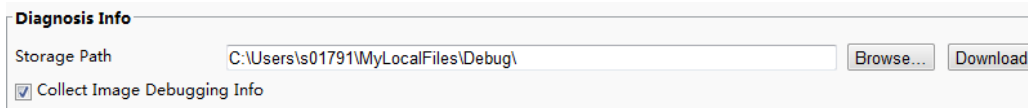

Diagnosis Info

Storage Path

Collect Image Debugging Info

2. Under **Diagnosis Info**, click **Browse** to select the destination folder, and then click **Download** to save the diagnostic information to the specified folder.

NOTE:

- Diagnostic information is exported to the local folder in form of a compressed file. You need to decompress the file using a tool such as WinRAR and then open the file using a text editor.
- Select **Collect Image Debugging Info**. Then the recording and the debugging information can be displayed synchronously for convenient troubleshooting.

Digital Zoom & Focus Configuration

Min. Focus Distance

The device can adjust the speed of auto-focus according to the minimum focus distance. In order to shoot clear objects, it is recommended that the minimum focus distance is set shorter than the distance between the objects and lens, for example, if the minimum focus distance is 3m, then the objects within 3m from lens will be out of focus.

1. Click **Setup > System > Maintenance**.



2. Configure **Minimum Focus** Distance under **Focus**.
3. Click **OK**.

Max. Zoom Ratio

This section provides the zoom capabilities, which is digital zoom capabilities.

1. Click **Setup > System > Maintenance**.

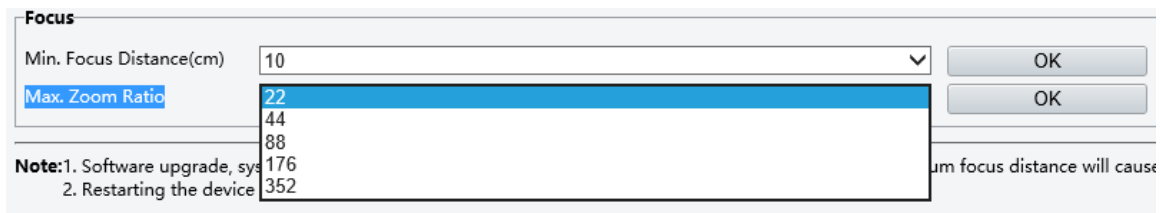

2. Configure zoom ratio in dropdown menu. The smallest number is the camera optical zoom range.
3. Click **OK**.

NOTE:

- This digital zoom functionality is *ONLY* available in 3MP, 4K H.265 models.

Live View

Live view means playing live video (real-time audio and video) received from a camera in a window through the Web interface.

If you log in with the **Live View** check box selected, live video appears by default when you are logged in. You may double-click the window to enter or exit full screen mode.

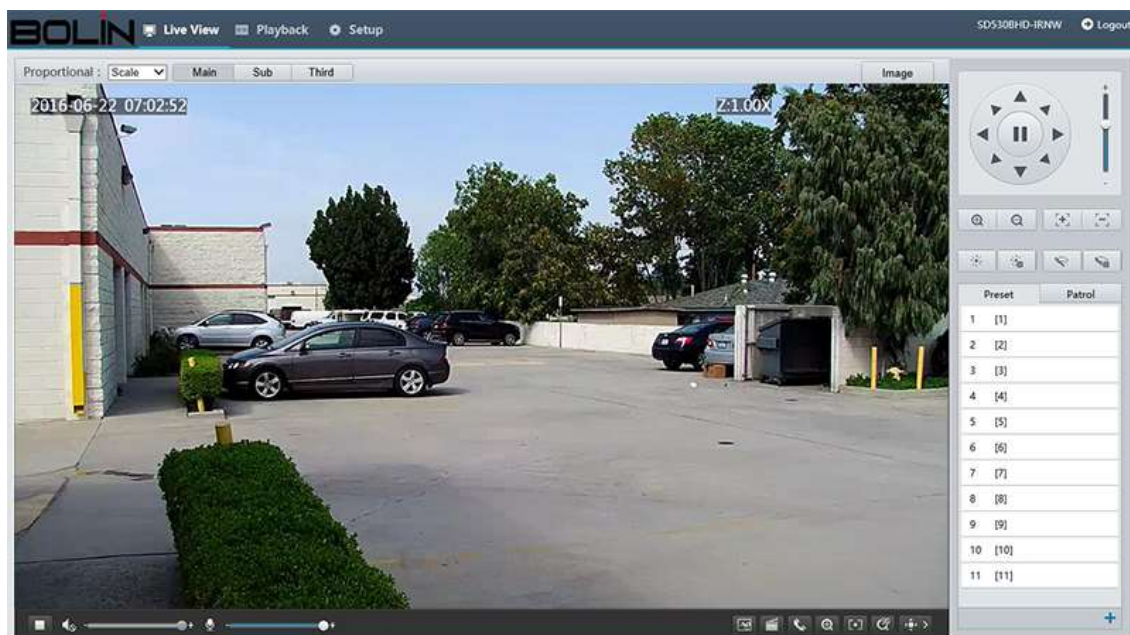

Live View Toolbar

NOTE:

The supported live view operations may vary with camera model. For the operations that your camera supports, see the Web interface.

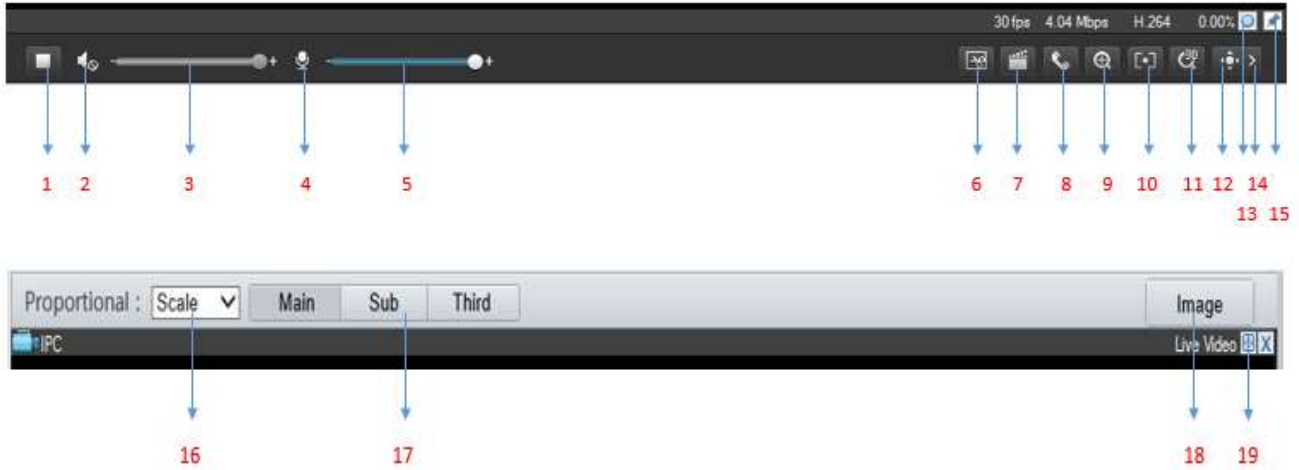

1. Play/stop live video.
2. Turn On/Off speaker.
3. Adjust the output volume for the media player on the PC.
4. Turn On/Off mic.
5. Adjust the microphone volume on the PC during audio communication between the PC and the camera.
6. Take a snapshot of the current image displayed on the PC. The path for saving snapshots is set in **System Configuration**.
7. Start/stop local recording. The path for saving local recordings is set in **System Configuration**.
8. Start/stop audio communication between the PC and the camera.
9. Start/stop digital zoom. For more details, see [Using Digital Zoom](#).
10. Start/stop Area Focus.
11. Start/stop 3D positioning. For more details, see [Using 3D Positioning](#).
12. Show/hide the PTZ control panel.
13. Reset the packet loss rate to zero. After you move the mouse cursor on a live view window, this button appears on the floating toolbar.
14. Collect/Expend Tool Bar.
15. Display packet loss rate and bit rate information in the bottom.
 - a. After you move the mouse cursor on a live view window, this button appears on the floating toolbar. Click this icon to display the bottom information.
 - b. Click this icon again, the bottom information is displayed if the mouse cursor is moved on a live view window or on the bottom information, and it hides automatically if the mouse cursor remains on a live view window for 3 seconds or leaves the window.
16. Set the display ratio of the image.
 - a. Scale: display images by 16:9
 - b. Stretch: display images by window size
 - c. Original: display images in its original size
17. Select a live video stream that the camera supports: main stream, sub stream or third stream.
18. Click this button to open the image setting page.
19. Display in full screen mode.

Viewing Certain Area of Images



Digital zoom and 3D positioning allow you to get more details of certain part of images. Digital zoom enlarges an image with loss in image quality, while 3D positioning enlarges an image without.

Using 3D Positioning

NOTE:

- *This function is available only for network PTZ cameras and network box cameras equipped with motorized zoom lens and PTZ. Please see actual models for details.*

3D Positioning provides an easy way to target an object, to which you can move PTZ quickly.

1. On the **Live View** page, click  on the toolbar.
2. Click and hold the mouse button, and then drag from up to down to specify an area that you want to watch. PTZ will move and zoom in to the target automatically.
3. Click and hold the mouse button, and then drag from down to up to zoom out.
4. To exit, click .



Video Playback and Download with Edge Storage

NOTE:

- *Edge storage refers to recording video to the memory card of a frontend device (mostly a camera). Local recording refers to recording video to a local PC client.*
- *Before you play back video with edge storage, check that the camera has been installed with a memory card and storage has been configured.*

1. *This function is not supported by some models, please see actual models for details.* Click **Playback** on the home page.

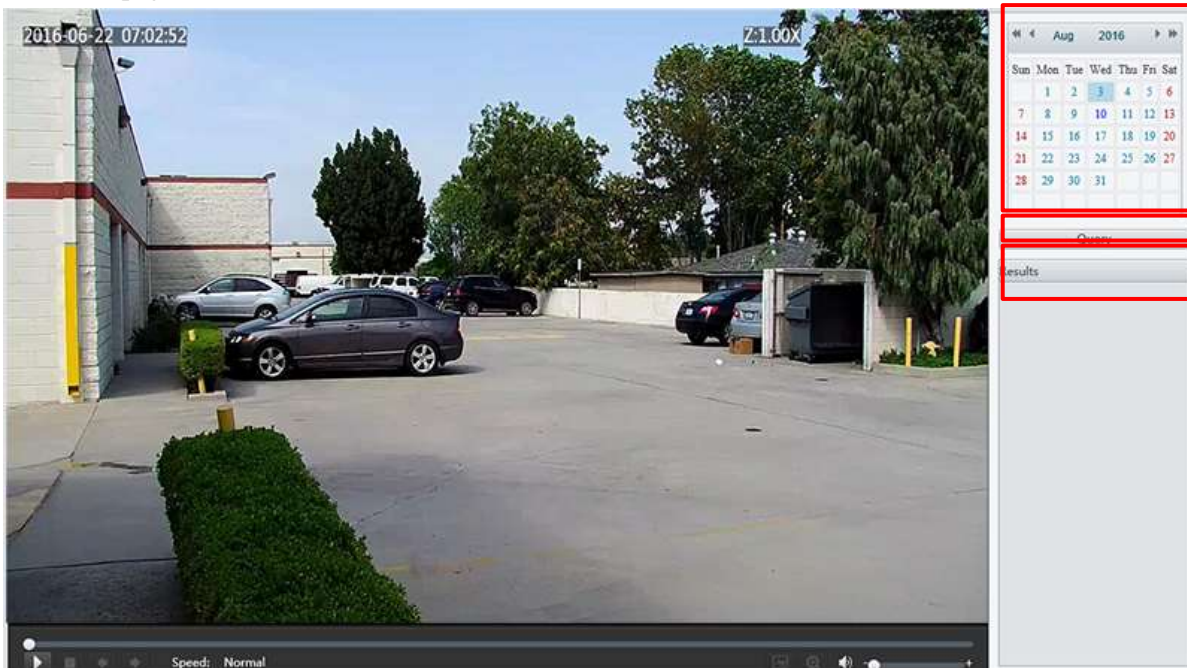

2. Select the date from the calendar.
3. Click **Query**.
4. Under **Results**, double-click the time period to start playing the recording.

Download

1. Click **Setup > Storage > Record Download**.
2. Search for video within a specified period. The results will be shown in a list.
3. Select your video and click **Download**. The video will be downloaded to your local path from the memory card (local path can be changed in **System Configuration**).
4. Click **Open Folder** to show the folder where the downloaded video is saved.

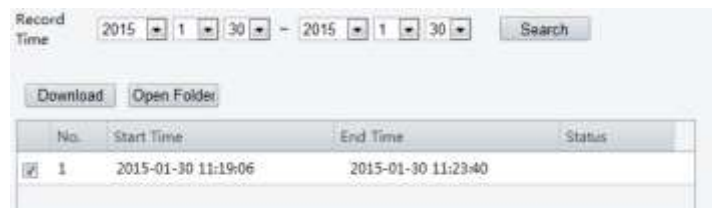

PTZ Control

This function is available only for the PTZ dome cameras or a box camera installed on a Pan/Tilt motor.

NOTE:

- Some of the lens control functions are applicable to cameras equipped with motorized lens.
- The PTZ control buttons may vary with camera model. For the PTZ control buttons that your camera supports, see the Web interface.

PTZ Control Toolbar

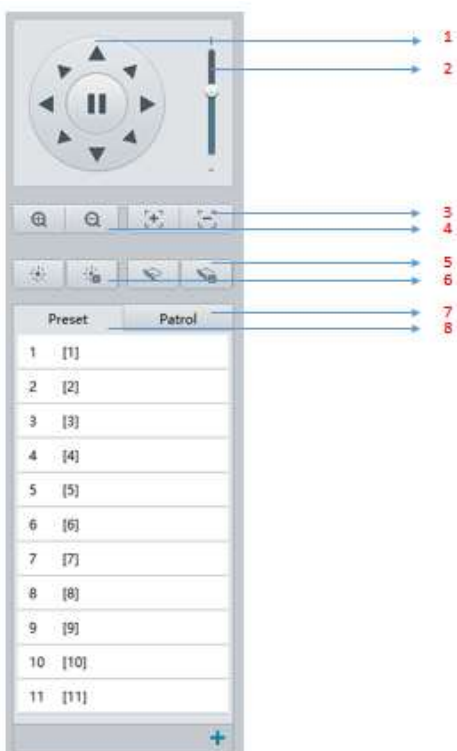

1. Control the direction of the PTZ camera and release the control.
2. Adjust the moving speed of the PTZ camera.
3. Adjust camera focus.
4. Adjust camera zoom.
5. Turn on or off the wiper.
6. Turn on or off the heater.
7. Select a patrol route and then click to start patrol.
 - To edit a patrol route, click .
 - To add a patrol route, click .
 - To delete a patrol route, click .
8. Select a preset and then click . The PTZ camera goes to the selected preset. To add a preset, click . To delete a preset, click .

Setting Patrol by Presets

Setting Presets

On the **Preset** tab, you can manage presets or perform certain control operations to the PTZ camera. For more details, see [PTZ Control Toolbar](#).

Add a preset

1. On the **Live View** page, click **Preset** on the control panel.
2. Adjust the camera till it points toward the desired direction.
3. Adjust zoom and focus as needed to obtain the optimal image.

Click **+** to add it as a preset. Enter a number and name for the preset and then click **Submit**.

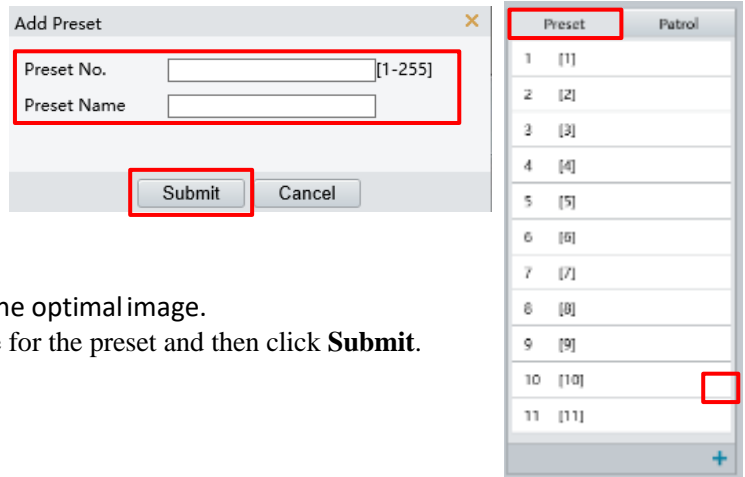

Go to a preset

1. On the **Live View** page, click **Preset** on the control panel.
2. Click  for a preset. The PTZ camera goes to the selected preset.

Delete a preset

1. On the **Live View** page, click **Preset** on the control panel.
2. Click  for a preset and then confirm the delete.

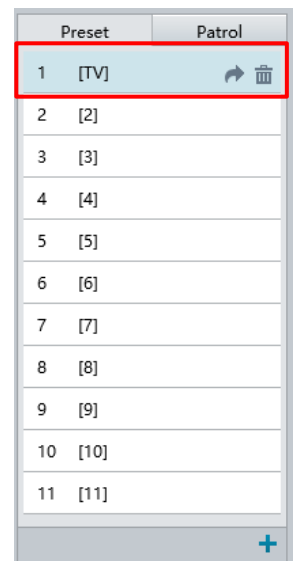

Setting Patrol

A patrol route is the track by which a PTZ camera follows when moving from a preset to the next. The length of time that a PTZ camera stays at each preset is configurable. Multiple patrol routes are allowed for a PTZ camera.

Patrol actions include going to a preset and staying at the preset for a certain amount of time before going to the next. You can set the rotation direction, zoom, rotation speed, patrol time, and stay time. The system records the route and adds it to the action list. You may select **Keep Rotating** so the PTZ camera follows the same route and patrols repeatedly.

Add a patrol route

1. On the **Live View** page, click **Patrol** on the control panel.
2. Click .
3. On the **Add Patrol** page, enter the route ID and name, and then click **Add** to add a patrol action. Use the buttons to adjust the sequence of the actions.

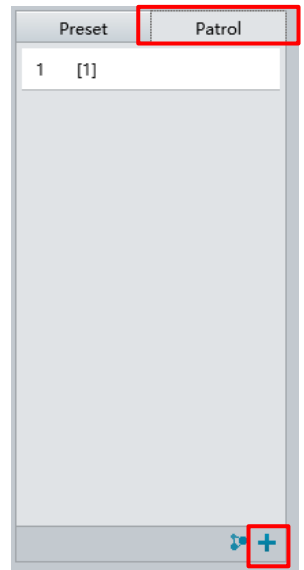
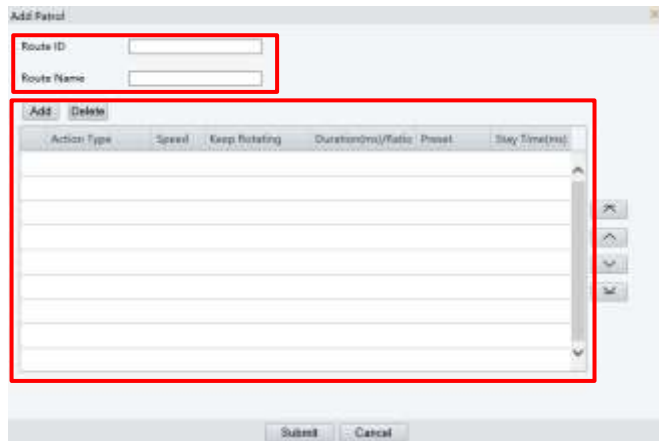





Patrol actions include:

- Go to a preset and stay for a certain amount of time before going to the next preset.
- Rotate at the set speed in the set direction for a certain amount of time, zoom, stay at a set position for a certain amount of time, or patrol repeatedly if **Keep Rotating** is selected.

It is recommended that the first action type is **Go to Preset**.

Click Submit. Record a patrol route

1. On the **Live View** page, click **Patrol** on the control panel.
2. Click  to start recording the patrol route. You can adjust the direction and zoom of the camera during the recording. The system records the motion and track of the camera and adds them to the action list.
3. Click  to finish recording. Then the patrol route is saved as a mode route automatically. You can click  to start patrol or  to delete the mode route.

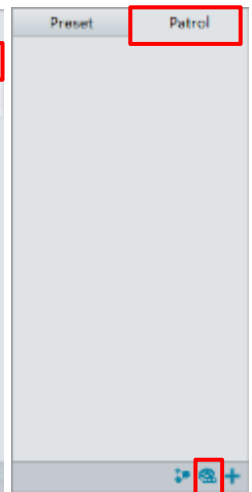
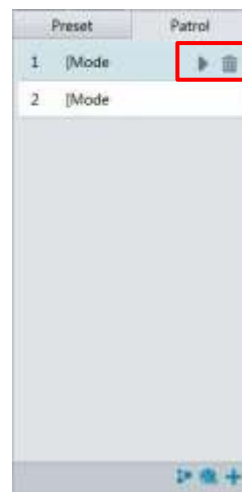

Make a patrol plan

1. On the **Live View** page, click **Patrol** on the control panel.
2. Click . The page for setting patrol plans is displayed.
3. Set the correct patrol time and route.
4. Select **Enable Patrol Plan**.

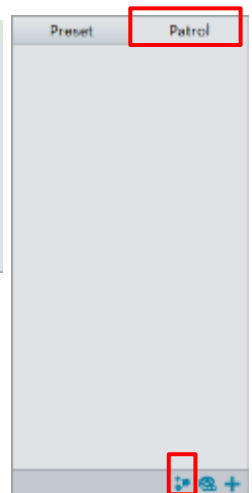
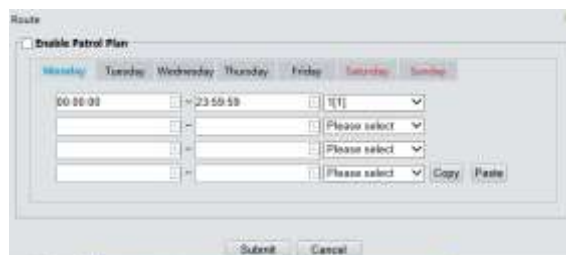

Click Submit. Start a patrol route

After you have added a patrol route, select the patrol route to start patrol.

1. On the **Live View** page, click **Patrol** on the control panel.
2. Click  for the patrol route you want to start.

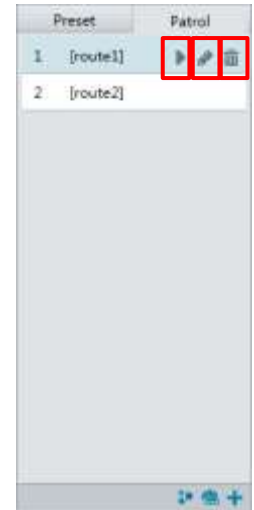

Edit a patrol route

1. On the Live View page, click **Patrol** on the control panel.
2. Click  for the patrol route you want to edit and modify the settings as required.

Delete a patrol route

1. On the Live View page, click **Patrol** on the control panel.
2. Click  for the patrol route you want to delete and then confirm the delete.

Setting Home Position

PTZ camera will return to home position if no operation is made within a specified period.

1. Click **Setup > PTZ > Home Position**.
2. Select the desired preset as the home position and set the time. To add a preset, [see Add a preset](#).
3. Click **Save**.

Preset	<input type="text" value="1(Main Lab)"/>
Time(s)	<input type="text" value="360"/>

Remote Control PTZ

When the third-party platform is used and the PTZ protocol does not match that, you can set the remote control function to control the PTZ.

1. Click **Setup > PTZ > Remote Control**.
2. Under **Remote Control**, select **Enable** and set the listener port and address code.
3. Click **Save**.

Remote Control	<input checked="" type="checkbox"/> Enable
Listener Port	<input type="text" value="10008"/>
Address Code	<input type="text" value="1"/>

NOTE:

- The listener port is the local port number of the camera and cannot be set as an occupied port. Please keep the default port number for general conditions.
- The camera can read the address code in the instruction. If it is the same as the address code on the Web, the camera can parse the instruction.

Preset Snapshot

When an alarm is triggered to the preset, the camera can snapshot and upload images to the FTP server. Please complete FTP settings and snapshot alarm settings before you enable this function.

1. Click **Setup > PTZ > Patrol**.
2. Select **Enable**.
3. Click **Save**.

Preset Snapshot	<input checked="" type="checkbox"/> Enable
<input type="button" value="Save"/>	

Appendix A Glossary

Acronym	Description
ARP	Address Resolution Protocol
CBR	Constant Bit Rate
DNS	Domain Name Service
DDNS	Dynamic Domain Name Service
DHCP	Dynamic Host Configuration Protocol
DST	Daylight Saving Time
FTP	File Transfer Protocol
GOP	Group Of Pictures
GUI	Graphical User Interface
HTTPS	Hyper Text Transfer Protocol over SSL
IE	Internet Explorer
IMOS	IP Multimedia Operation System
IP	Internet Protocol
IPC	IP Camera
MTU	Maximum Transmission Unit
NTP	Network Time Protocol
OSD	On Screen Display
PoE	Power over Ethernet
PPPoE	Point-to-Point Protocol over Ethernet
PTZ	Pan, Tilt, Zoom
ROI	Region of Interest
SMTP	Simple Mail Transfer Protocol
SSL	Secure Socket Layer
UNP	Universal Network Passport
USB	Universal Serial Bus
VBR	Variable Bit Rate
WDR	Wide Dynamic Range

Specifications

HD Models

Model No.	SD530BHD-IRNA
Camera	30X
Image Sensor	1/2.8" CMOS 2MP
Lens	30X, 4.5–135mm, 16X Digital Zoom
Horizontal Angle of View	62.9°(W)~2.3°(T)
Aperture	F1.6(W)~F4.4(T)
Min. Illumination	0.025 lux(F1.6, AGC ON, Color), 0.0025 lux(F1.6, AGC ON, BW)
Shutter Speed	1/6–1/8000s
Focus	Auto, Push
White Balance	Auto, Manual
Exposure	Auto, Manual, Shutter/Iris Priority
Day/Night	YES
Backlight Compensation	YES
WDR	YES, 120db
Privacy Zone Masking	YES
Defog	YES
Motion Detection	YES, 4 Zones
Noise Reduction	2D/3D
S/N Ratio	≥50db
Mechanical	
Pan Movement	Horizontal: ±360° continuous pan (Zoom Adaptive Speed Range: 0.1°~150°/S)
Tilt Movement	Vertical: +90° to -15° (Zoom Adaptive Speed Range: 0.1°~90°/S)
Preset Position	255 (Preset Speed: 150°/S)
Home Position	YES
Cruise	Support up to 8 different path movements
Environmental	Outdoor/Indoor, IP67, Corrosion Resistant T treated Housing
Infrared	The adaptive infrared can be synchronized with different zoom angle. Illumination distance is up to 100 Meters.
Noise of Movement	< 54db
Network	
Video Compression	MJPEG, H.264, H.265
Resolution/Frame Rate	1080p: 60/50/30/25fps; 720p:30/25fps
Protocols	L2TP, IPv4, IGMP, ICMP, ARP, TCP, UDP, DHCP, PPPoE, RTP, RTSP, QoS, DNS, DDNS, NTP, FTP, UPnP, HTTP, SNMP, SIP
Multi-stream	3 data stream function will satisfy various bandwidth, frame rates and storage requirements in real time
Audio Compression	AAC-LC Broadband Audio Encoding
OSD	Customized OSD
Compatible Integration	ONVIF 2.4
Interface	
Network	10M/100M/1000M Base-TX Ethernet, RJ45
Video: Analog (Tail-Cable A)	1XBNC
Audio I/O (Tail-Cable A)	Input: Impedance 35kΩ, Amplitude 2V [p-p]; Output: Impedance 600kΩ, Amplitude 2V [p-p]
Alarm I/O (Tail-Cable A)	Alarm Input X1, Alarm Output 1X1
Control (Tail-Cable A)	RS485 (Not Activated)
Edge Storage	Micro SD, Up to 128GB (Optional)
General	
Operating Temperature	-40°C to +60°C
Operating Humidity	80% Suitable for Use
Power Input	AC 24V, PoE 80W (Bolin PoE 80W Injector needed, optional)
Power Consumption	10W (Close IR) 20W (Open IR)
Dimension	Φ210×333mm
Weight	5.2kg
Rain Wiper	Optional

STARLIGHT Models

Model No.	SD520BHD-IRNXGA
Camera	20X
Image Sensor	1/2.8" CMOS 2MP
Lens	20X, 6.7~134mm, 16X Digital Zoom
Horizontal Angle of View	58.7°(W)~3.9°(T)
Aperture	F1.5(W)~F3.4(T)
Min. Illumination	0.002 lux(F1.6, AGC ON, Color), 0.0002 lux(F1.6, AGC ON, B/W)
Shutter Speed	1/6~1/8000s
Focus	Auto, Push
White Balance	Auto, Manual
Exposure	Auto, Manual, Shutter/Iris Priority
Day/Night	YES
Backlight Compensation	YES
WDR	YES, 120db
Privacy Zone Masking	YES
Defog	YES
Motion Detection	YES, 4 Zones
Noise Reduction	2D/3D
S/N Ratio	≥50db
Mechanical	
Pan Movement	Horizontal: ±360° continuous pan (Zoom Adaptive Speed Range: 0.1°~150°/S)
Tilt Movement	Vertical: +90° to -15° (Zoom Adaptive Speed Range: 0.1°~90°/S)
Preset Position	255 (Preset Speed: 150°/S)
Home Position	YES
Cruise	Support up to 8 different path movements
Environmental	Outdoor/Indoor, IP67, Corrosion Resistant Treated Housing
Infrared	The adaptive infrared can be synchronized with different zoom angle. Illumination distance is up to 100 Meters.
Noise of Pan/Tilt Movement	< 54db
Network	
Video Compression	MJPEG, H.264, H.265
Resolution/Frame Rate	1080p: 60/50/30/25fps; 720p: 30/25fps
Protocols	L2TP, IPv4, IGMP, ICMP, ARP, TCP, UDP, DHCP, PPPoE, RTP, RTSP, QoS, DNS, DDNS, NTP, FTP, UPnP, HTTP, SNMP, SIP
Multi-stream	3 data stream function will satisfy various bandwidth, frame rates and storage requirements in real time
Audio Compression	AAC-LC Broadband Audio Encoding
OSD	Customized OSD
Compatible Integration	ONVIF 2.4
Interface	
Video: IP Network	10M/100M/1000M Base-TX Ethernet, RJ45
Video: Analog (Tail-Cable A)	1XBNC
Audio I/O (Tail-Cable A)	Input: Impedance 35kΩ, Amplitude 2V [p-p], Output: Impedance 600kΩ, Amplitude 2V [p-p]
Alarm I/O (Tail-Cable A)	Alarm Input X1, Alarm Output 1X1
Control (Tail-Cable A)	RS485 (Not Activated)
Edge Storage	Micro SD, Up to 128GB (Optional)
General	
Operating Temperature	-40°C to +60°C
Operating Humidity	80% Suitable for Use
Power Input	AC 24V, PoE 80W (Bolin PoE 80W Injector needed, optional)
Power Consumption	10W (Close IR) 20W (Open IR)
Dimension	Φ210×333mm
Weight	5.5kg
Rain Wiper	Optional

4K Models

Model No.	SD522B4K-IRNA
Camera	22X
Image Sensor	1/1.7" CMOS 8MP
Lens	22X, 6.5~143mm, 16X Digital Zoom
Horizontal Angle of View	59.6°(W)~3.9°(T)
Aperture	F1.5(W)~F3.4(T)
Min. Illumination	0.025 lux(F1.5, AGC ON, Color), 0.0025 lux(F1.5, AGC ON, B/W)
Shutter Speed	1/6~1/8000s
Focus	Auto, Push
White Balance	Auto, Manual
Exposure	Auto, Manual, Shutter/Iris Priority
Day/Night	YES
Backlight Compensation	YES
WDR	YES, 120db
Privacy Zone Masking	YES
Defog	YES
Motion Detection	YES, 4 Zones
Noise Reduction	2D/3D
S/N Ratio	≥50db
Mechanical	
Pan Movement	Horizontal: ±360° continuous pan (Zoom Adaptive Speed Range: 0.1°~150°/S)
Tilt Movement	Vertical: +90° to -15° (Zoom Adaptive Speed Range: 0.1°~90°/S)
Preset Position	255 (Preset Speed: 150°/S)
Home Position	YES
Cruise	Support up to 8 different path movements
Environmental	Outdoor/Indoor, IP67, Corrosion Resistant Treated Housing
Infrared	The adaptive infrared can be synchronized with different zoom angle. Illumination distance is up to 100 Meters.
Noise of Pan/Tilt Movement	< 54db
Network	
Video Compression	MJPEG, H.264, H.265
Resolution/Frame Rate	12MP(4000X3000)20; 8MP(3840X2160)30/25; 6MP(3072X2048)30/25; 5MP(3072X1728)30/25; 2560*2048p.30/25; 2560*1920P30/25; 3MP(2048X1536)30/25; 2MP(1920X1080)30/25
Protocols	L2TP, IPv4, IGMP, ICMP, ARP, TCP, UDP, DHCP, PPPoE, RTP, RTSP, QoS, DNS, DDNS, NTP, FTP, UPnP, HTTP, SNMP, SIP
Multi-stream	3 data stream function will satisfy various bandwidth, frame rates and storage requirements in real time
Audio Compression	AAC-LC Broadband Audio Encoding
OSD	Customized OSD
Compatible Integration	ONVIF 2.4
Interface	
Network	10M/100M/1000M Base-TX Ethernet, RJ45
Video: Analog (Tail-Cable A)	1XBNC
Audio I/O (Tail-Cable A)	Input: Impedance 35kΩ, Amplitude 2V [p-p]; Output: Impedance 600kΩ, Amplitude 2V [p-p]
Alarm I/O (Tail-Cable A)	Alarm Input X1, Alarm Output 1X1
Control (Tail-Cable A)	RS485 (Not Activated)
Edge Storage	Micro SD, Up to 128GB (Optional)
General	
Operating Temperature	-40°C to +60°C
Operating Humidity	80% Suitable for Use
Power Input	AC 24V, PoE 80W (Bolin PoE 80W Injector needed, optional)
Power Consumption	10W (Close IR) 20W (Open IR)
Dimension	Φ210×333mm
Weight	5.8kg
Rain Wiper	Optional

Dimensions

S-Type
Unit: mm

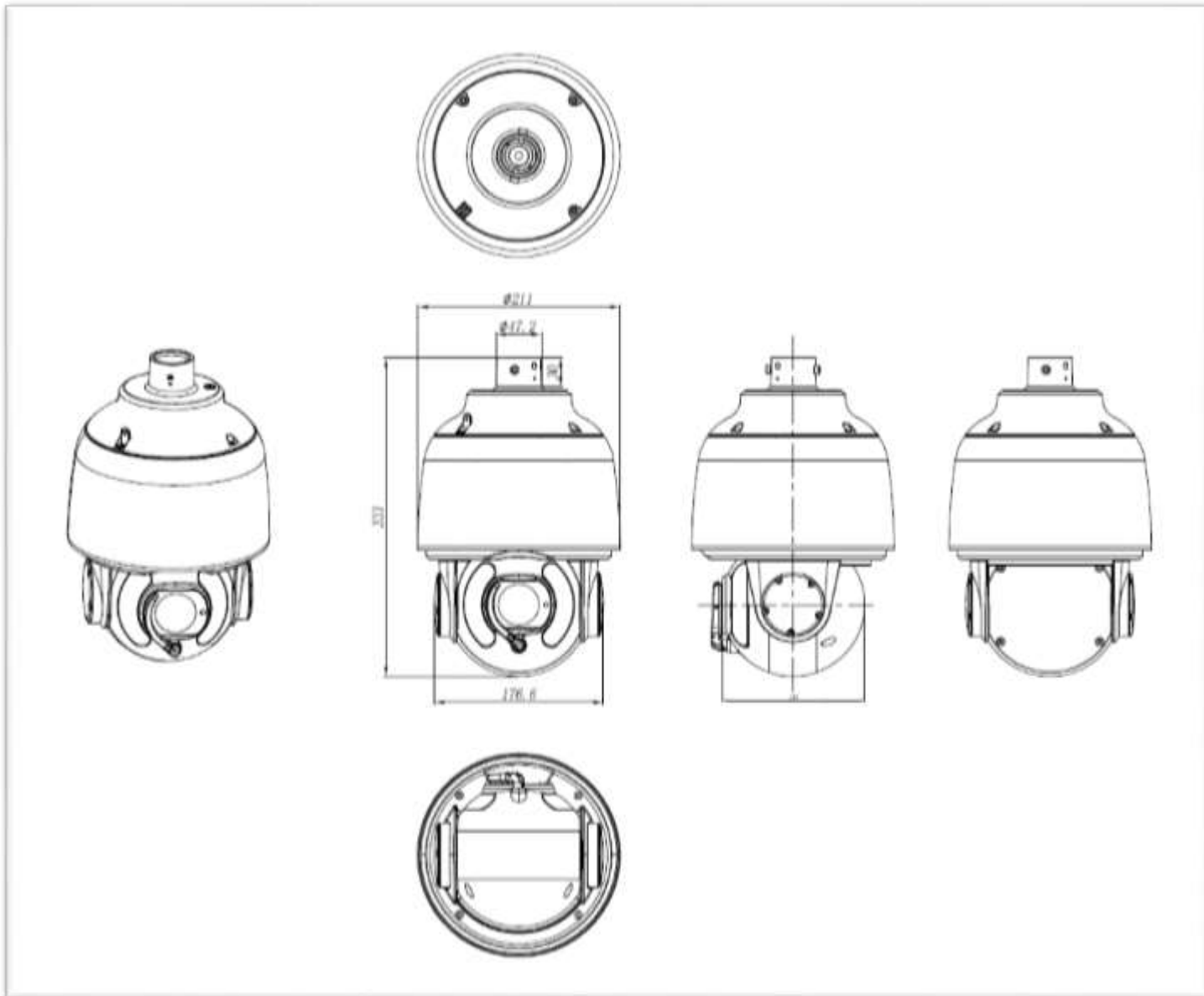

L-Type
Unit:mm

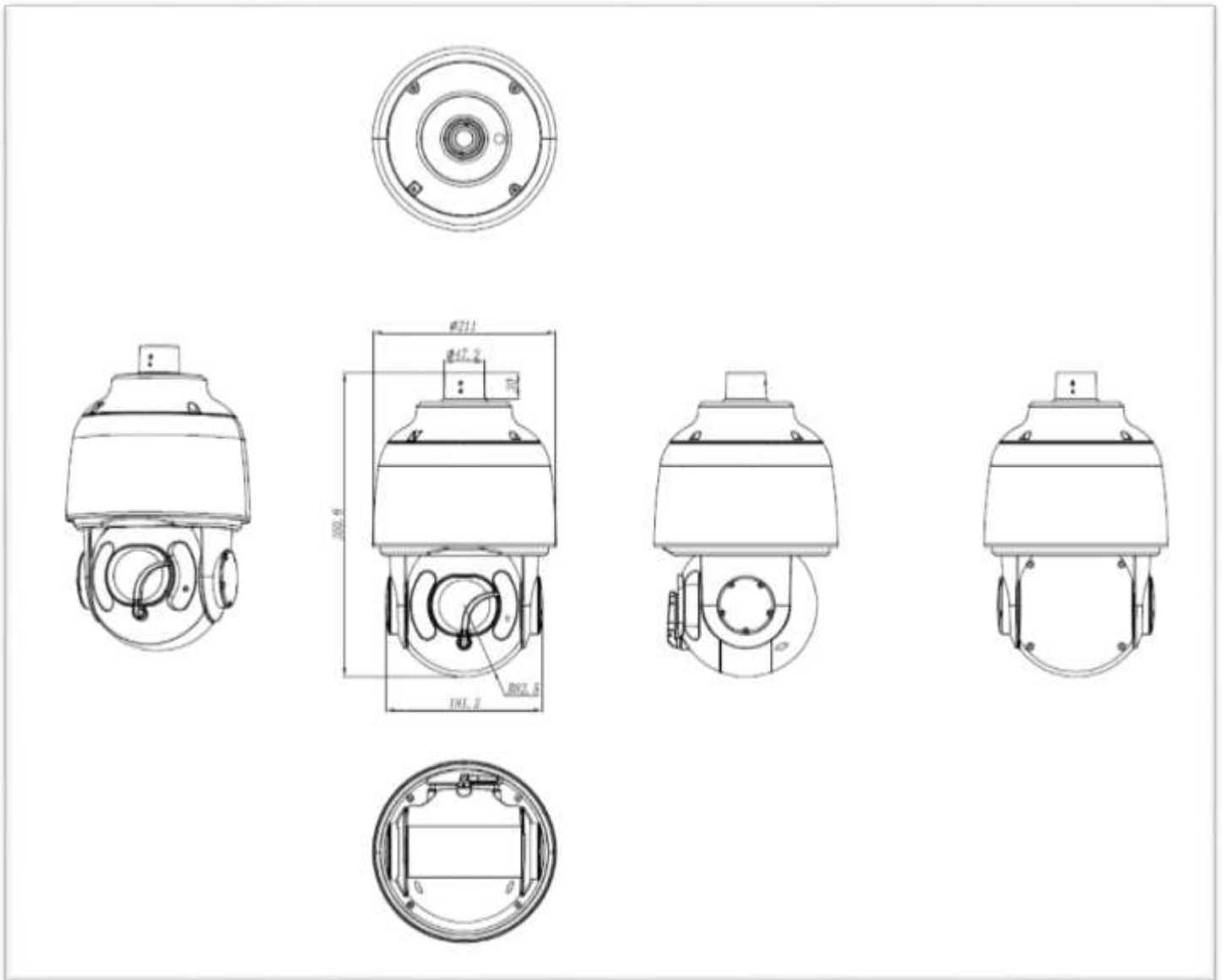

Model: BL-PP80 (80w PoE Power Injector)

Unit:mm

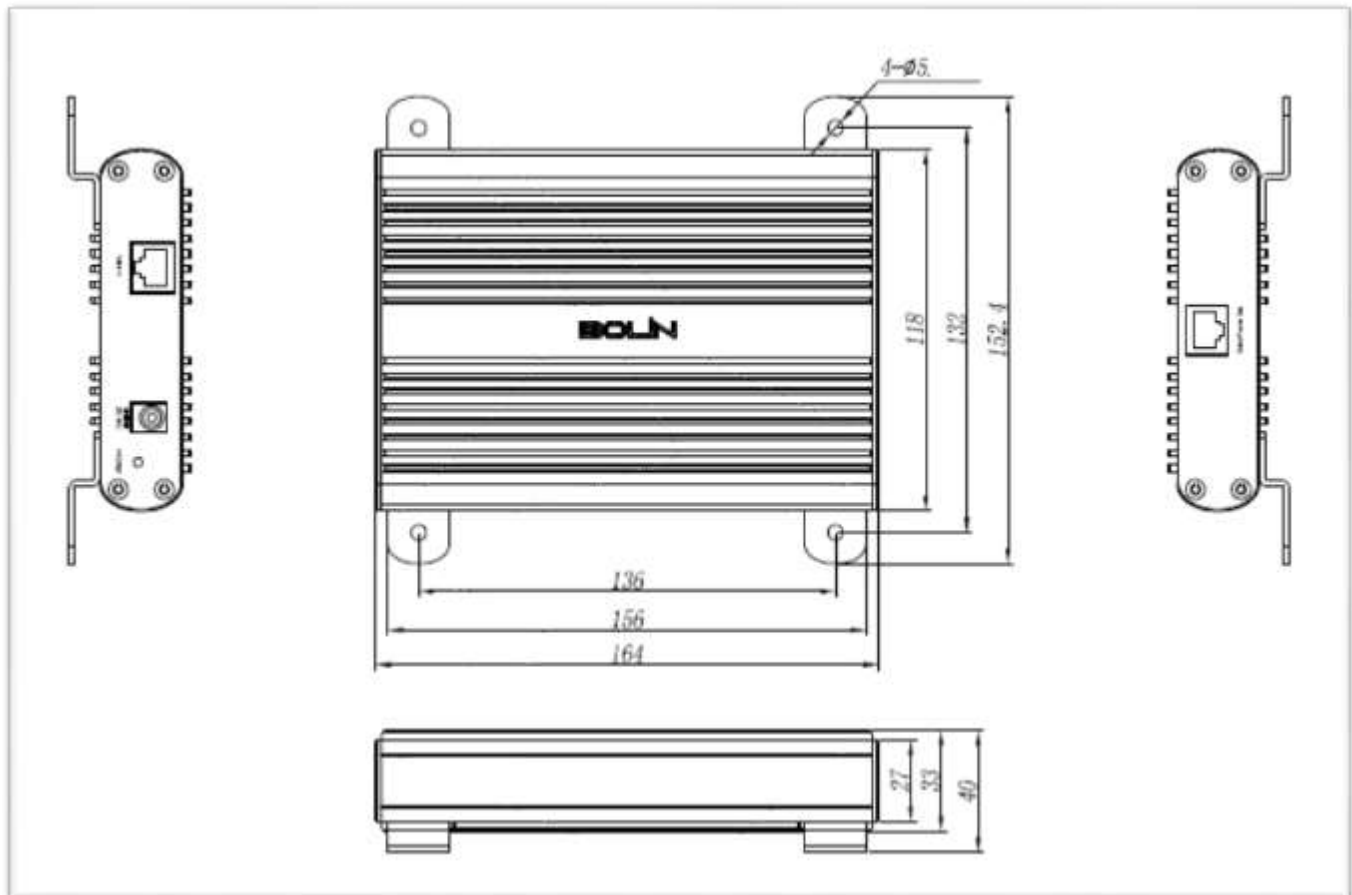



www.bolintechnology.com

2082 TECHNOLOGY LLC
dba
BOLIN TECHNOLOGY