

datavideo



HD 12-CHANNEL PORTABLE
VIDEO STREAMING STUDIO

HS-3200

Instruction Manual

www.datavideo.com

Table of Contents

FCC COMPLIANCE STATEMENT	7
WARNINGS AND PRECAUTIONS	7
WARRANTY	8
<i>STANDARD WARRANTY</i>	8
<i>THREE YEAR WARRANTY</i>	8
DISPOSAL	9
CHAPTER 1 INTRODUCTION	10
1.1 SYSTEM ARCHITECTURE	11
1.2 PARTS IDENTIFICATIONS	12
1.3 CONTROL PANEL OVERVIEW	13
1.4 CONNECTING THE POWER SUPPLY	14
CHAPTER 2 PREPARATION	15
2.1 CONNECTING DEVICES	15
<i>Connecting the Video and Audio Input Devices</i>	15
<i>Connecting headphones</i>	16
<i>When linking via tally connection</i>	16
<i>Connecting the Video and Audio Output Devices</i>	17
<i>Connecting to a Network</i>	17
2.2 MULTI VIEW.....	18
CHAPTER 3 NETWORK AND SOFTWARE SETUP FOR SWITCHER	21
3.1 SWITCHER SETUP WITH A WINDOWS COMPUTER.....	21
3.2 INSTALLING THE SWITCHER IMAGE IMPORT/EXPORT SOFTWARE TO A WINDOWS COMPUTER	22
<i>Installation</i>	22
<i>Router Based DHCP Setup</i>	26
<i>Setting the Target IP Address with the Switcher Image Import/Export Software</i>	27
CHAPTER 4 OSD MENU	30
4.1 START	37
<i>Transition</i>	37
<i>Type</i>	37
<i>Wipe Effects</i>	37
<i>WIPE Border</i>	38
<i>Position</i>	38
<i>Matte</i>	38
4.2 KEYER	38
<i>Keyer</i>	39
<i>Keyer Control</i>	39

<i>Key Source</i>	40
<i>Fill Source</i>	40
<i>Invert</i>	41
<i>Mask</i>	41
4.3 CHROMA	41
<i>Keyer</i>	41
<i>Key Source</i>	42
<i>CK Setup</i>	42
<i>Mask</i>	43
4.4 P-IN-P	43
<i>Keyer</i>	43
<i>Position</i>	44
<i>Border</i>	44
<i>Shade Matte (Dual Color Border)</i>	45
<i>Crop</i>	46
4.5 FLEX SRC.....	46
<i>Flex Screen</i>	47
<i>Quick</i>	47
4.6 INPUTS	49
<i>Input</i>	49
<i>Proc Amp</i>	49
<i>Audio</i>	49
<i>Crosspoint</i>	50
<i>Audio XPT</i>	50
4.7 OUTPUTS.....	50
<i>Outputs</i>	51
<i>Multiviewer</i>	51
<i>Tally Mode</i>	52
<i>GPI Out</i>	52
4.8 AUDIO.....	52
<i>Audio</i>	53
<i>PGM Audio</i>	53
<i>Analog Out</i>	53
4.9 FILES.....	54
<i>User Mems</i>	54
Load Memory.....	54
Save Memory	54
<i>Still</i>	55
Load Still	55
Save Still	55
Grab Still.....	56
Loading still images	57
<i>Clip</i>	57

Load Clip.....	58
Clip Settings.....	58
Loading the existing Clip for Stinger Transition Effect.....	58
4.10 SETUP	59
<i>Standard</i>	59
<i>Menu Mode</i>	60
<i>Menu Preference</i>	60
<i>Level</i>	60
<i>Keyboard</i>	60
<i>Auto Save</i>	60
<i>Factory Default</i>	61
<i>Language</i>	61
<i>Network</i>	61
<i>Software</i>	61
CHAPTER 5 BASIC OPERATION.....	62
5.1 VIDEO SWITCHING	62
<i>Program and Preset rows</i>	62
<i>Black and MATTE View</i>	62
<i>Flex Output</i>	63
<i>Still button</i>	63
5.2 TRANSITIONS	63
<i>WIPE Selection MENU</i>	65
<i>REV Button</i>	66
5.3 MANAGING STILL PICTURES.....	66
<i>Grabbing & Saving a Still to memory</i>	66
<i>Loading an existing Still from memory</i>	67
<i>Deleting a saved Still from memory</i>	67
<i>FS – Frame Store Button (No Function)</i>	67
<i>Export/Import Still Images to/from the PC</i>	68
How to use	68
5.4 PERFORMING A STINGER TRANSITION	71
<i>Loading a Clip from memory</i>	71
<i>How to Create the PNG Sequence for Stinger Transition Effect</i>	71
Adobe After Effects.....	72
Media Encoder CC.....	74
Important things to note while creating Stinger Transition Effects	77
<i>Importing the Clip for Stinger Transition Effect from the PC</i>	78
CHAPTER 6 ADVANCED OPERATION	81
6.1 PICTURE-IN-PICTURE AND DOWNSTREAM KEY	82
<i>Picture-In-Picture</i>	82
Assigning a video source to a PIP window using shortcut keys.....	84

<i>Downstream Key</i>	84
6.2 PLACING TEXT ON THE VIDEO USING LUMA KEY	85
6.3 INSERTION OF PEOPLE ONTO BACKGROUNDS (CHROMA KEY)	87
6.4 DISPLAYING A VARIETY OF SOURCES AT THE SAME TIME	90
<i>Basic Flex™ Output (Four PIP Windows)</i>	90
Assigning a video source to a PIP window using shortcut keys.....	93
<i>Simultaneously Display up to Eight PIP Windows</i>	93
CHAPTER 7 VIDEO STREAMING.....	96
7.1 STREAMING NETWORK CONNECTION AND SETUP.....	96
<i>Finding the NVS-31's current IP address</i>	96
7.2 WEB USER INTERFACE	97
<i>Source</i>	98
<i>Encoder</i>	99
<i>Record</i>	102
Main Record Column	103
Storage Information Column	103
Storage Content	103
<i>Streaming</i>	103
RTSP Mode	104
RTMP Mode	105
TS Mode	106
<i>System</i>	107
Network Setting	107
Account Setup	108
Firmware Update	108
Time Setting	109
System Related	110
CHAPTER 8 MONITOR OSD MENU	111
8.1 MAIN ADJUST.....	112
8.2 COLOR	112
8.3 INFORMATION	112
8.4 SPECIAL FUNCTION	113
8.5 FACTORY RESET.....	113
CHAPTER 9 APPENDICES.....	114
APPENDIX 1 TALLY OUTPUTS	114
APPENDIX 2 GPI / GPO CONNECTIONS	116
APPENDIX 3 FIRMWARE UPDATE.....	117
<i>T-Bar Re-Calibration</i>	117
APPENDIX 4 FREQUENTLY-ASKED QUESTIONS.....	119
APPENDIX 5 DIMENSIONS & WEIGHT.....	120
APPENDIX 6 SPECIFICATIONS	121

Disclaimer of Product & Services

The information offered in this instruction manual is intended as a guide only. At all times, Datavideo Technologies will try to give correct, complete and suitable information. However, Datavideo Technologies cannot exclude that some information in this manual, from time to time, may not be correct or may be incomplete. This manual may contain typing errors, omissions or incorrect information. Datavideo Technologies always recommend that you double check the information in this document for accuracy before making any purchase decision or using the product. Datavideo Technologies is not responsible for any omissions or errors, or for any subsequent loss or damage caused by using the information contained within this manual. Further advice on the content of this manual or on the product can be obtained by contacting your local Datavideo Office or dealer.

FCC Compliance Statement

This device complies with part 15 of the FCC rules. Operation is subject to the following two conditions:

- (1) This device may not cause harmful interference, and
- (2) This device must accept any interference received, including interference that may cause undesired operation.

Warnings and Precautions



1. Read all of these warnings and save them for later reference.
2. Follow all warnings and instructions marked on this unit.
3. Unplug this unit from the wall outlet before cleaning. Do not use liquid or aerosol cleaners. Use a damp cloth for cleaning.
4. Do not use this unit in or near water.
5. Do not place this unit on an unstable cart, stand, or table. The unit may fall, causing serious damage.
6. Slots and openings on the cabinet top, back, and bottom are provided for ventilation. To ensure safe and reliable operation of this unit, and to protect it from overheating, do not block or cover these openings. Do not place this unit on a bed, sofa, rug, or similar surface, as the ventilation openings on the bottom of the cabinet will be blocked. This unit should never be placed near or over a heat register or radiator. This unit should not be placed in a built-in installation unless proper ventilation is provided.
7. This product should only be operated from the type of power source indicated on the marking label of the AC adapter. If you are not sure of the type of power available, consult your Datavideo dealer or your local power company.
8. Do not allow anything to rest on the power cord. Do not locate this unit where the power cord will be walked on, rolled over, or otherwise stressed.
9. If an extension cord must be used with this unit, make sure that the total of the ampere ratings on the products plugged into the extension cord do not exceed the extension cord rating.
10. Make sure that the total amperes of all the units that are plugged into a single wall outlet do not exceed 15 amperes.
11. Never push objects of any kind into this unit through the cabinet ventilation slots, as they may touch dangerous voltage points or short out parts that could result in risk of fire or electric shock. Never spill liquid of any kind onto or into this unit.
12. Except as specifically explained elsewhere in this manual, do not attempt to service this product yourself. Opening or removing covers that are marked "Do Not Remove" may expose you to dangerous voltage points or other risks, and will void your warranty. Refer all service issues to qualified service personnel.
13. Unplug this product from the wall outlet and refer to qualified service personnel under the following conditions:
 - a. When the power cord is damaged or frayed;

- b. When liquid has spilled into the unit;
- c. When the product has been exposed to rain or water;
- d. When the product does not operate normally under normal operating conditions. Adjust only those controls that are covered by the operating instructions in this manual; improper adjustment of other controls may result in damage to the unit and may often require extensive work by a qualified technician to restore the unit to normal operation;
- e. When the product has been dropped or the cabinet has been damaged;
- f. When the product exhibits a distinct change in performance, indicating a need for service.

Warranty

Standard Warranty

- Datavideo equipment is guaranteed against any manufacturing defects for one year from the date of purchase.
- The original purchase invoice or other documentary evidence should be supplied at the time of any request for repair under warranty.
- The product warranty period begins on the purchase date. If the purchase date is unknown, the product warranty period begins on the thirtieth day after shipment from a Datavideo office.
- All non-Datavideo manufactured products (product without Datavideo logo) have only one year warranty from the date of purchase.
- Damage caused by accident, misuse, unauthorized repairs, sand, grit or water is not covered under warranty.
- Viruses and malware infections on the computer systems are not covered under warranty.
- Any errors that are caused by unauthorized third-party software installations, which are not required by our computer systems, are not covered under warranty.
- All mail or transportation costs including insurance are at the expense of the owner.
- All other claims of any nature are not covered.
- All accessories including headphones, cables, batteries, metal parts, housing, cable reel and consumable parts are not covered under warranty.
- Warranty only valid in the country or region of purchase.
- Your statutory rights are not affected.

Three Year Warranty

- All Datavideo products purchased after July 1st, 2017 qualify for a free two years extension to the standard warranty, providing the product is registered with Datavideo **within 30** days of purchase.



- Certain parts with limited lifetime expectancy such as LCD panels, DVD drives, Hard Drive, Solid State Drive, SD Card, USB Thumb Drive, Lighting, Non-PCIe Card and third party provided PC components are covered for 1 year.
- The three-year warranty must be registered on Datavideo's official website or with your local Datavideo office or one of its authorized distributors within 30 days of purchase.

Disposal

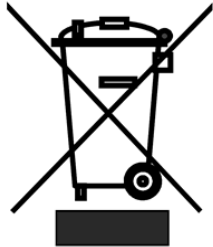

For EU Customers only - WEEE Marking

This symbol on the product or on its packaging indicates that this product must not be disposed of with your other household waste. Instead, it is your responsibility to dispose of your waste equipment by handing it over to a designated collection point for the recycling of waste electrical and electronic equipment. The separate collection and recycling of your waste equipment at the time of disposal will help to conserve natural resources and ensure that it is recycled in a manner that protects human health and the environment. For more information about where you can drop off your waste equipment for recycling, please contact your local city office, your household waste disposal service or the shop where you purchased the product.



CE Marking is the symbol as shown on the left of this page. The letters "CE" are the abbreviation of French phrase "Conformité Européene" which literally means "European Conformity". The term initially used was "EC Mark" and it was officially replaced by "CE Marking" in the Directive 93/68/EEC in 1993. "CE Marking" is now used in all EU official documents.

Chapter 1 Introduction

HS-3200 is a 12 channel professional mobile hand carry switcher with real Full 1080p/60 (3G) High Definition support, featuring 12 digital inputs including 8 SDI and 4 HDMI inputs with embedded audio, 5 SDI and 1 HDMI outputs for connecting HD recorder, external monitors and etc.

HS-3200 is a lightweight, portable and powerful featured mobile studio solution which is designed for live events and TV programs that need to mix a variety of video and audio sources. HS-3200 is also a great value solution for the worship, education and AV markets.

The HS-3200 also has powerful, easy-to-use effects, including Chroma / Luma Key, DSK, PIP, Wipe Generator, Still stores, logo insertion and built-in title overlay system for the entry level Datavideo CG.

Advanced features include a 17.3-inch Full HD 1080p video monitor, which displays the Multi-view. The Multi-view displays all video input sources, preview video and program video.

Major five features

- One machine for 12 channel 1080p video switching, recording and streaming
- Four video keyers
- Broadcast quality H.264 media streaming for sending videos to broadcast platforms like Facebook, Youtube
- Record on SD Card for post-production
- Pre-saved multiple sets of animation files and background pictures

Summary of all features

- 12 Total Video input interfaces (8 x SDI, 4 x HDMI)
- 9 Video Output : 5 x SDI + 1 HDMI + 3 x HDMI (Program OUT only)
- 4 Upstream Keyers, supporting Chroma key & Linear / Luma key
- 4 PIP (assignable to any of keyers)
- DSK, supporting Linear & Luma Key Modes
- Logo insertion (Animation logo, X/Y size)
- Wipe, Mix, DVE, Cut and Stinger Transitions
- 32 Wipe patterns including Circle & Heart, and Borders & Softness Control
- Clip player (150 Frames) Stinger Transitions function
- Any Input (1-12) can be used as a Frame store (Stills Store)
- Support XPT (Cross Point Assignment)
- 4 x XLR Analogue Audio Inputs
- 2 x XLR De-embedded Analogue Audio Outputs
- Tally output
- USB Port for FW upgrade

1.1 System Architecture

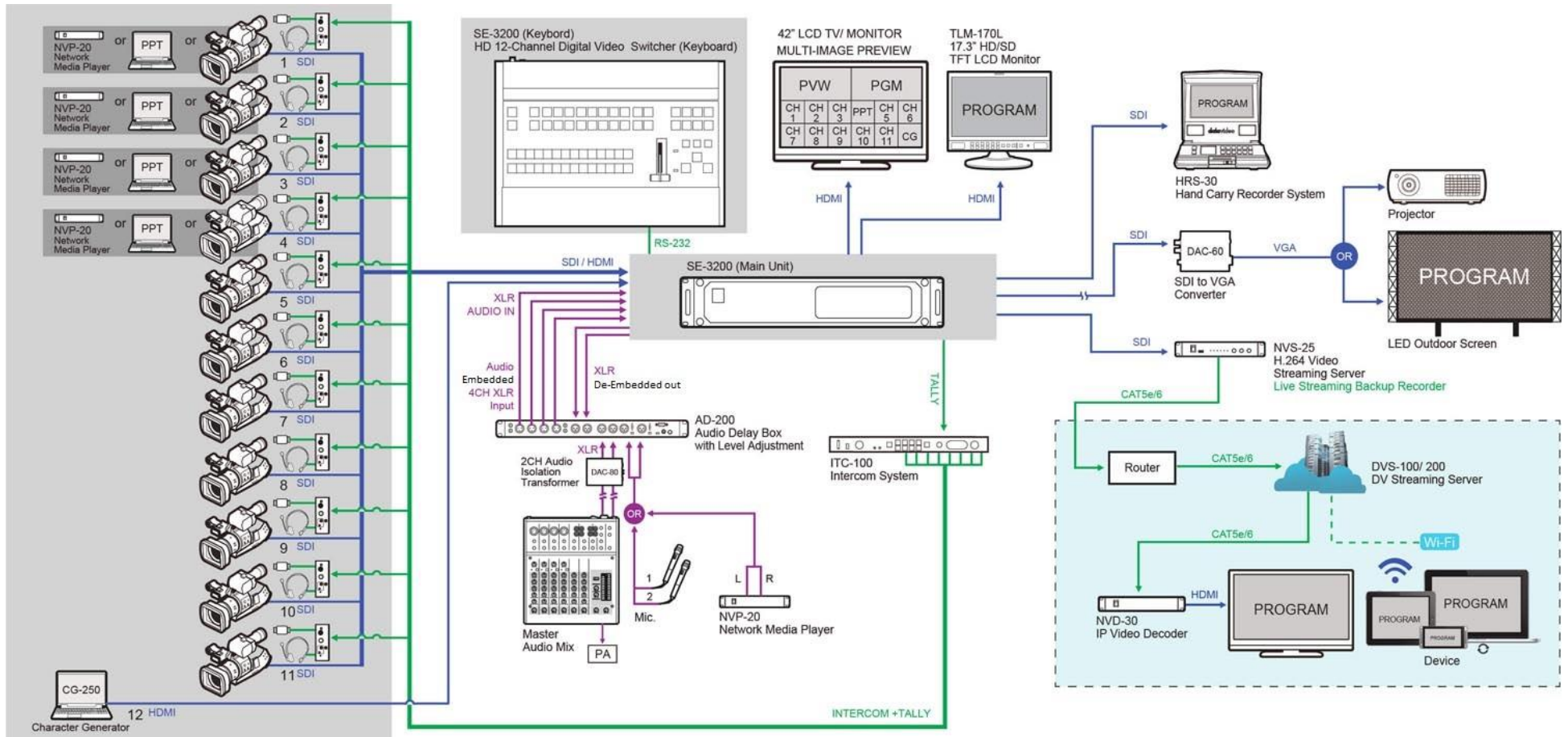

1.2 Parts Identifications

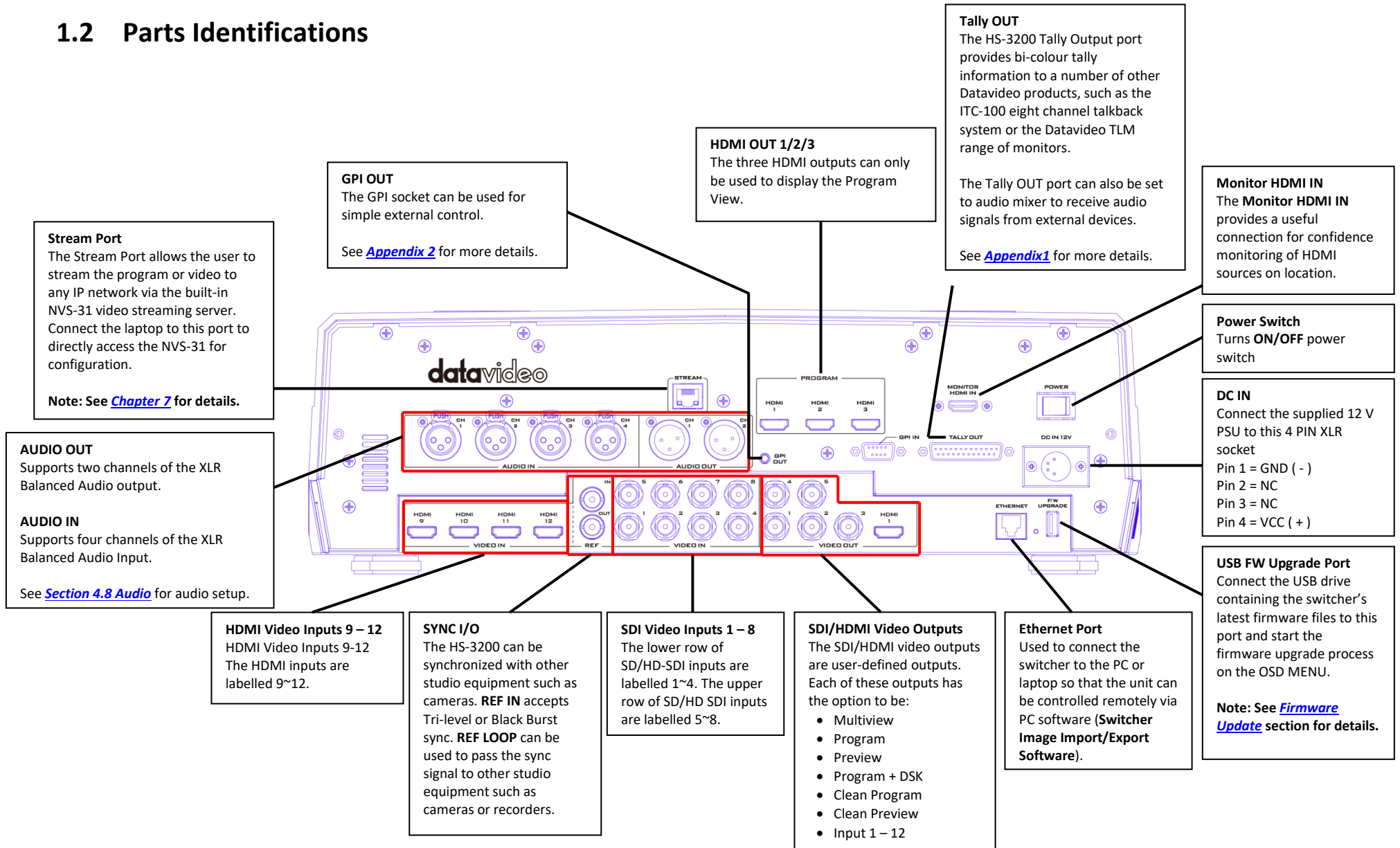

1.3 Control Panel Overview

Perform video switching and other relevant controls on the **Control Panel**.

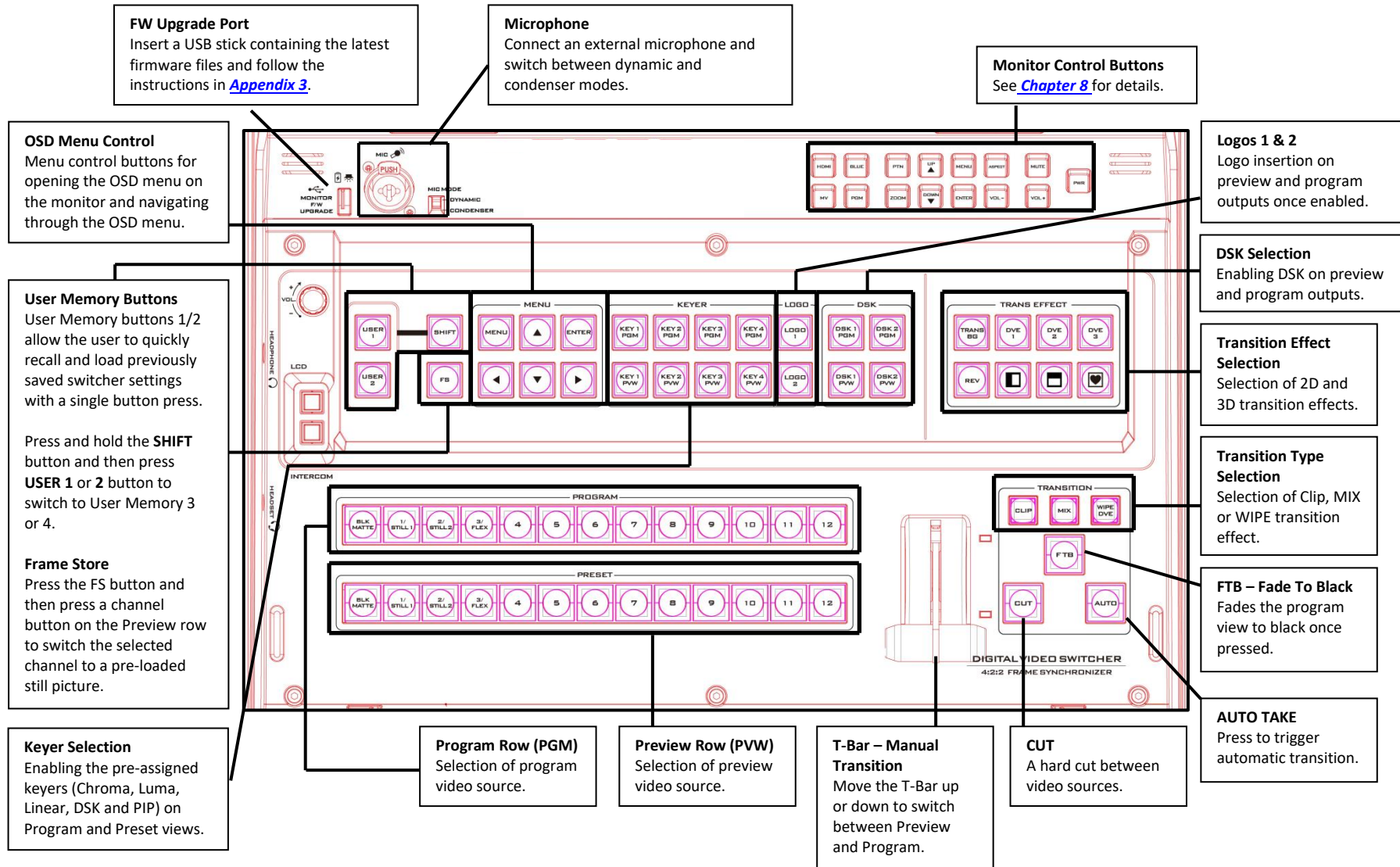

1.4 Connecting the Power Supply

Connect the DC output plug of the supplied AC adapter to the DC IN 12V connector on the rear of the switcher and then connect the AC adapter to a power supply.

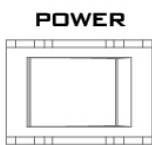
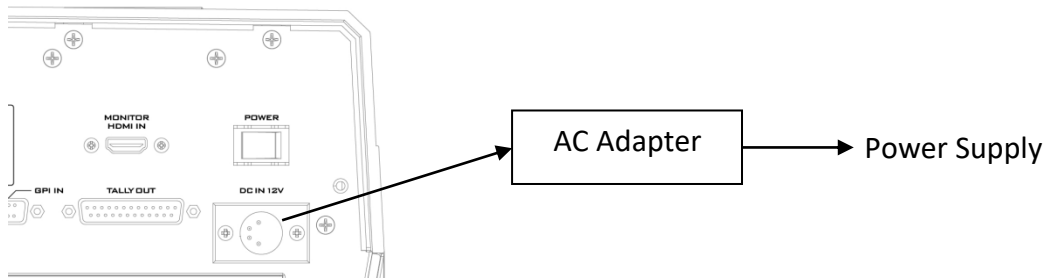

To start, turn **ON** the power switch.

To shut off the machine, simply turn **OFF** the power switch.

Chapter 2 Preparation

In this chapter, we will describe various essential devices to be connected to the switcher in order to complete the system setup. If you possess the skills for setting up the production system, feel free to skip this chapter and proceed to [Chapter 5: Basic Operation](#).

2.1 Connecting Devices

Connecting the Video and Audio Input Devices

Connect cameras, computers and other video input devices to the video input connectors on the rear of the unit and connect an audio mixer to audio input connectors.

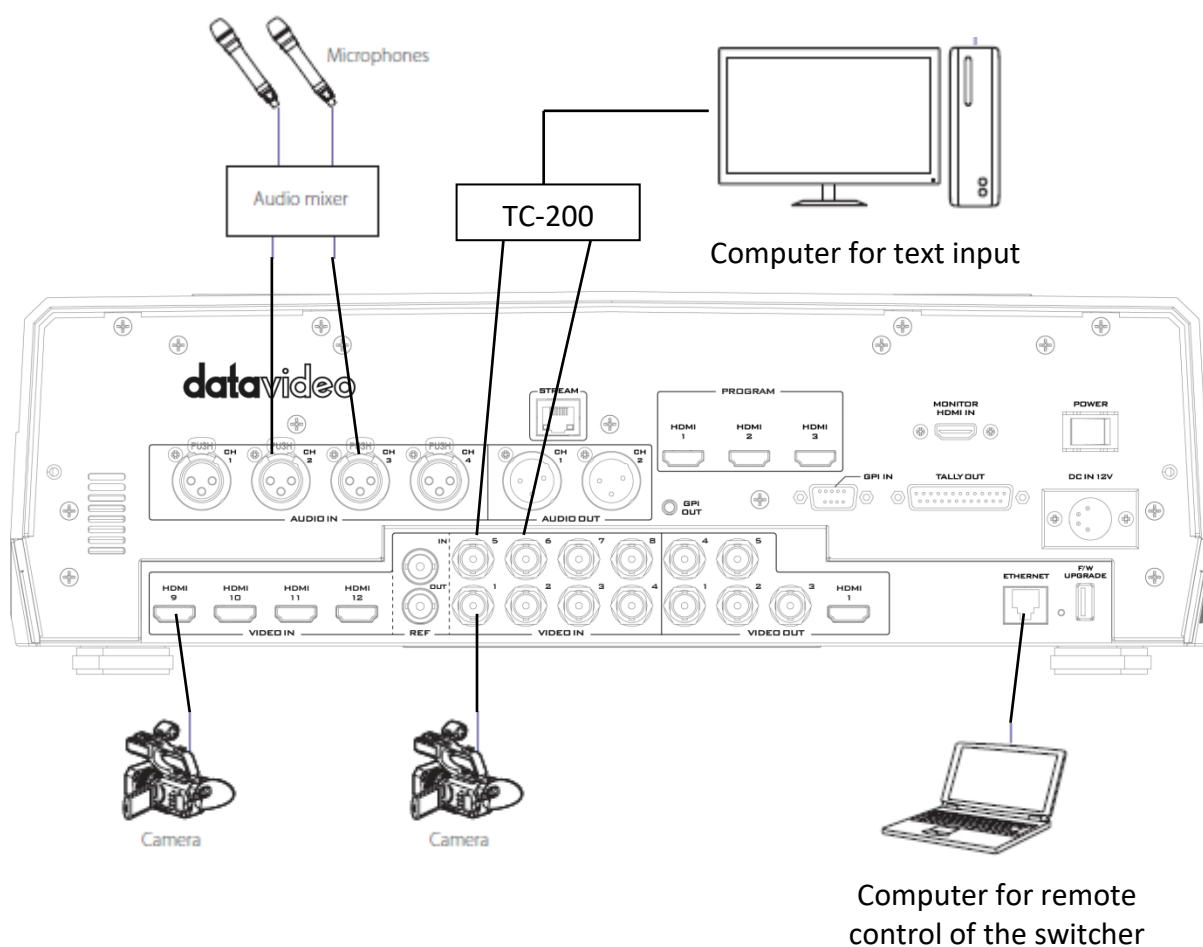

Connecting headphones

Connect headphones for audio monitoring to the headphone jack on the left side of the switcher.

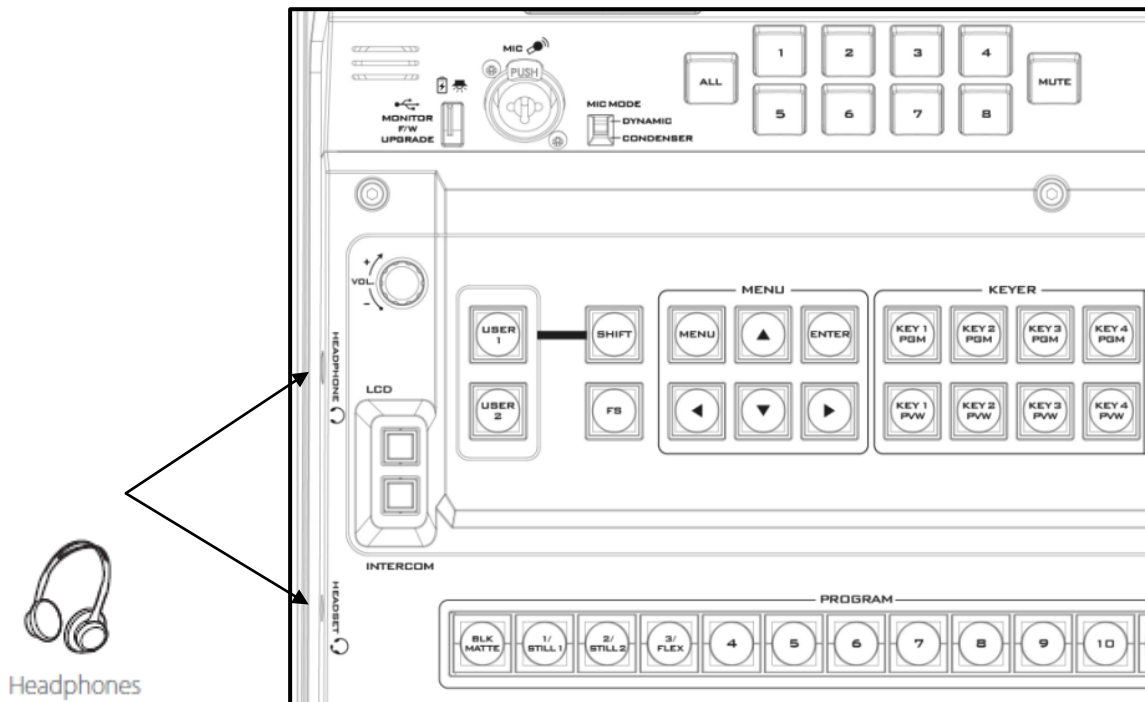

When linking via tally connection

Connect the switcher's tally connector to the tally connector on a commercially available tally box.

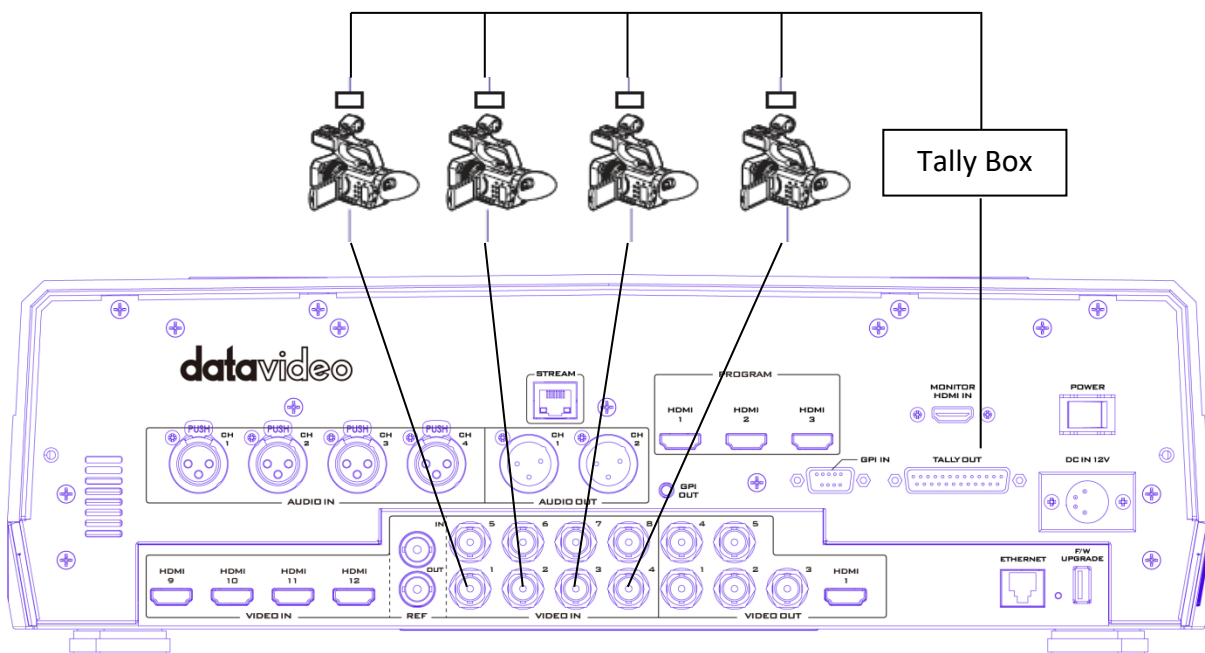

Connecting the Video and Audio Output Devices

Connect projectors, large displays and other video output devices to the video output connectors on the rear of the switcher.

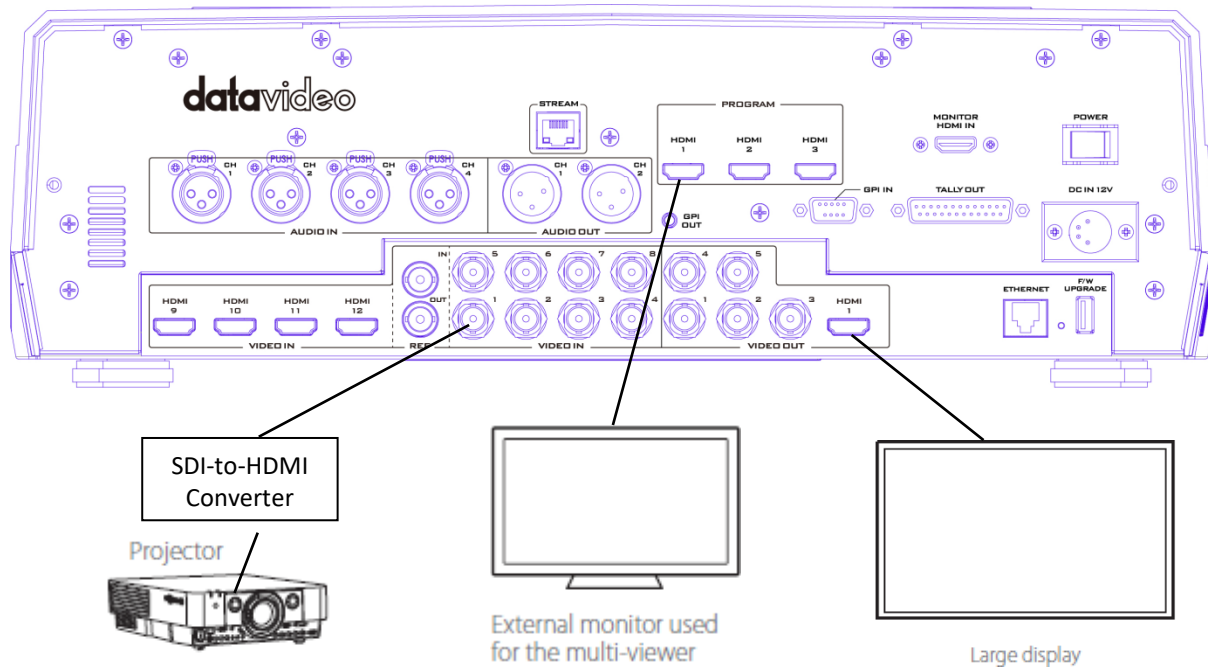

Connecting to a Network

Use the Ethernet Port to connect the switcher to the PC with the Image Import/Export Software installed.

For details on the Switcher Image Import/Export Software, see [Chapter 3](#).

If you intend to use the Ustream or other video streaming platforms, connect the switcher to the Internet via the Stream Port.

For details on stream network setup, see [Chapter 7](#).

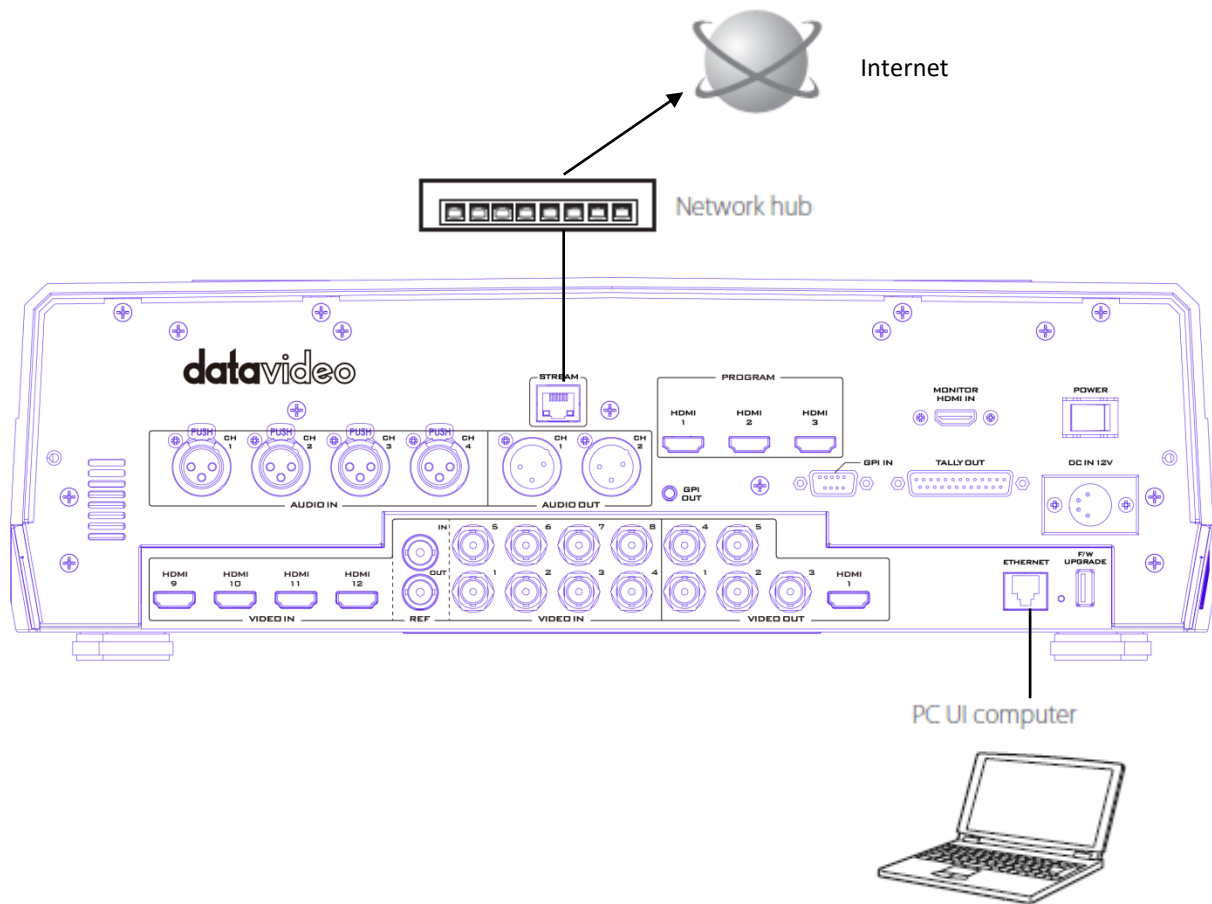

2.2 Multi View

The HS-3200 Multi view output can be supplied from the HDMI or SDI outputs, see Chapter 4 (4.7) for configuring the outputs. The Multi view shows monitoring images for **Preview** (PVW), **Program** (PGM) and Inputs 1~12. The Multi view can also show **audio level bars** overlaid on the Program image. This confirms the analogue XLR audio input is being received and embedded to the selected Program output(s).

HS-3200 Multi-view is supplied from the HDMI connection(s) on the rear panel and available across multiple HDMI monitors (not supplied). Since a variety of multi-image layouts is available, these HDMI outputs can be used to monitor video and audio in a number of different configurations. The layout of the multi view can also be changed. The sources can be swapped around using the cross point section of the Inputs menu. For each setup, embedded audio level indication is available on the Preview and Program windows.

The diagrams below depict four different multi-view layouts available on the HS-3200.

Mode 1:

Preview		Program	
1	2	3	4
5	6	7	8

Mode 2:

Preview		Program		
1	2			
3	4	5	6	7
8	9	10	11	12

Mode 3:

Preview			Program		
1	2	3	4	5	6
7	8	9	10	11	12

Mode 4:

Program		1
		2
3	4	5

A Red tally indication box is shown around the selected Program source. This video image is also seen at the switcher's selected Program output(s). **A Green tally indication box** is shown around the selected Preview source. This will be the image source to be mixed to, wiped in or cut to next depending on the user's preference.

Chapter 3 Network and Software Setup for Switcher

The Ethernet port on the back panel of the HS-3200 allows the user to import Still/Clip image or User memory using the Switcher Image Import/Export software. This chapter discusses direct connection between the HS-3200 and your Windows computer as well as the remote setup in detail. **Please note that the Switcher Image Import/Export software must be installed on your Windows-based computer before using this feature.**

3.1 Switcher Setup with a Windows Computer

When new from the factory the HS-3200 will initially have a static IP address of **192.168.100.101**. The unit can be directly connected to a Windows-based computer using an RJ-45 ethernet cable. The following set up should allow you to initially configure the unit before moving it to an existing DHCP / LAN network.

- An RJ-45 Ethernet cable.
- Windows 7/8/10 laptop or PC.
- The Datavideo Switcher Image Import/Export software.

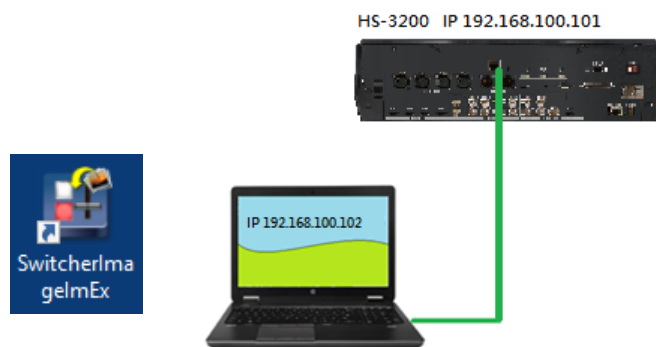

Instructions

1. First connect the HS-3200 and the Windows computer together using an RJ-45 ethernet cable.
2. Turn on the Windows computer and set it to **static IP setup** within the **Windows Network and Sharing Centre**. In our example, the computer is given the following IP settings so that the computer matches the same IP range as the switcher.

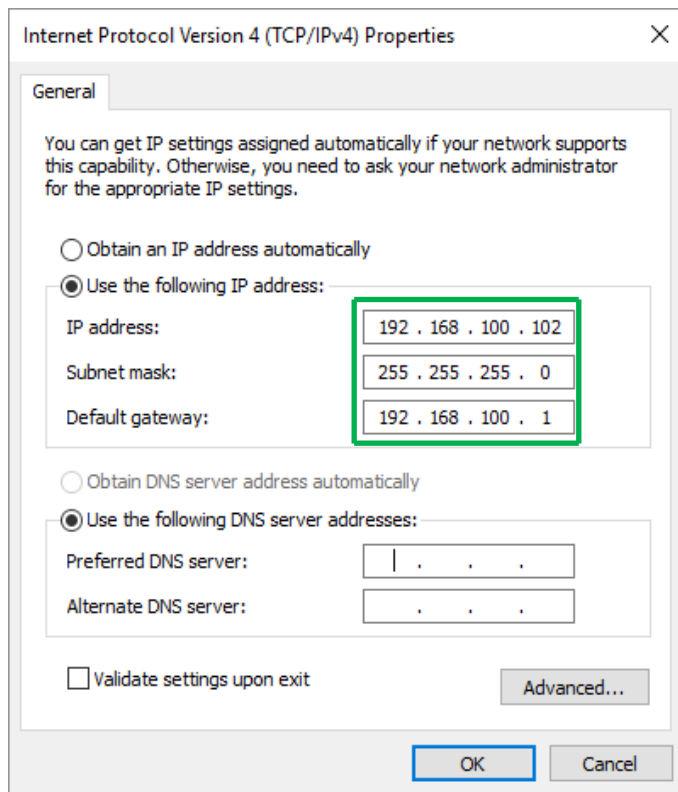

3. Now install the **Switcher Image Import/Export software** to the computer.

3.2 Installing the Switcher Image Import/Export software to a Windows Computer

The HS-3200 can be connected to a simple IP network and accessed using Windows-based software. If you have not already set up the HS-3200 with a computer then please follow the instructions in the previous section.

Please download the latest software from the Datavideo HS-3200 web page. See:

www.datavideo.com

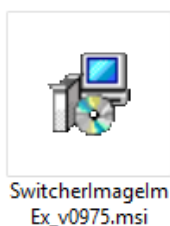

The install executable file [.msi] will be called **SwitcherImageImEx_vXXXX.msi**

The vXXXX represents the latest version number.

Double click this .msi file then **follow the on screen install wizard prompts.**

Installation

1. Download SwitcherImageImEx_vx.x.x.msi from the product page and save it on the local disk.
2. Click the installation file icon to start the Setup Wizard.
3. Click **“Next”**

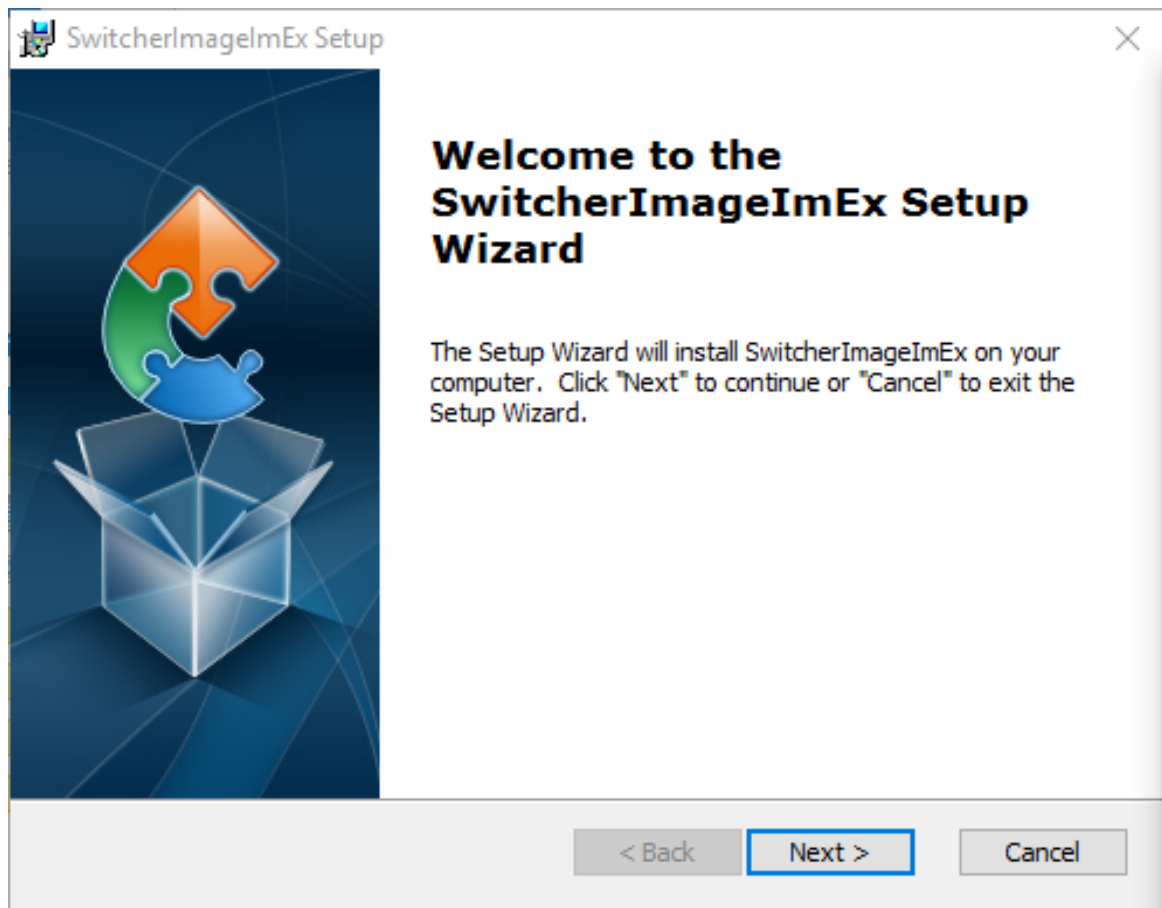

4. Click "Install"

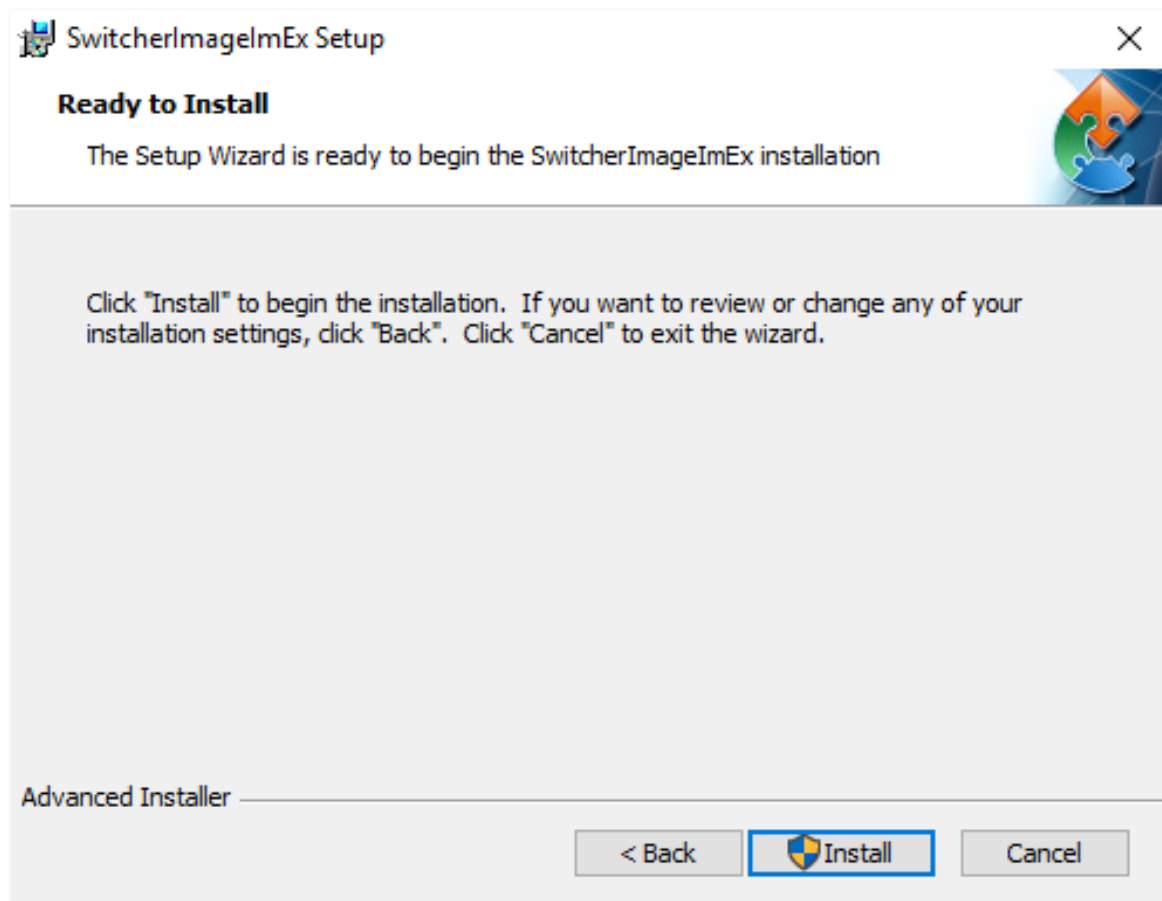

- When you see the safety warning requesting for permission to allow an unknown publisher to make changes to the PC, please click “Yes” to continue.

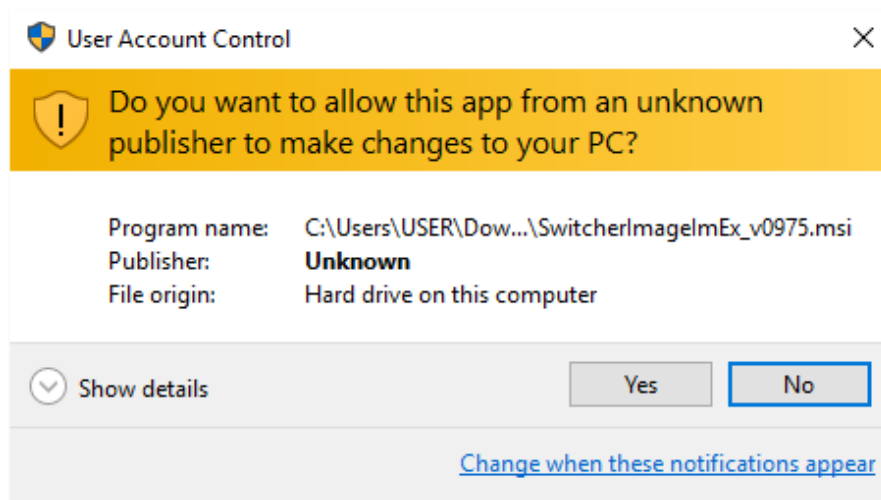

- Wait for the installation to finish.

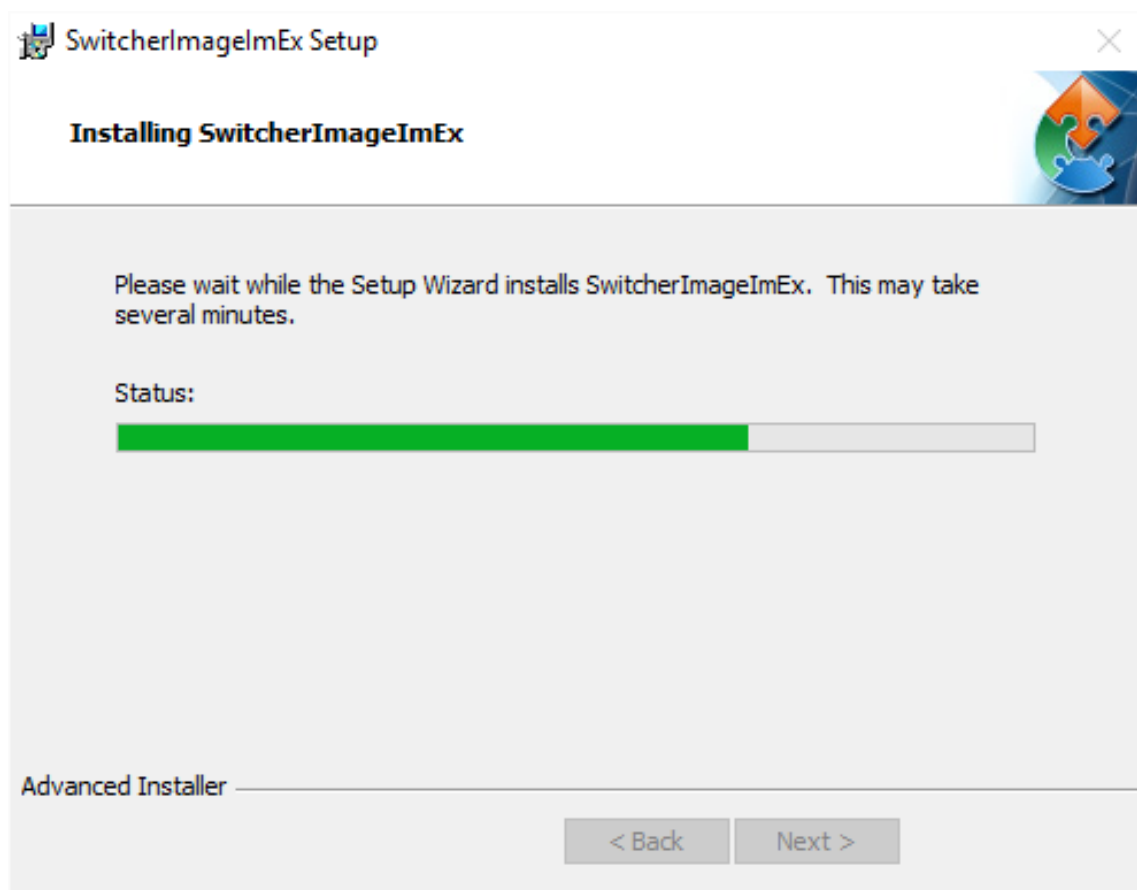

- After the setup is complete, you will see the following window; check “Launch SwitcherImagelmEX” and click “Finish” to open the program.

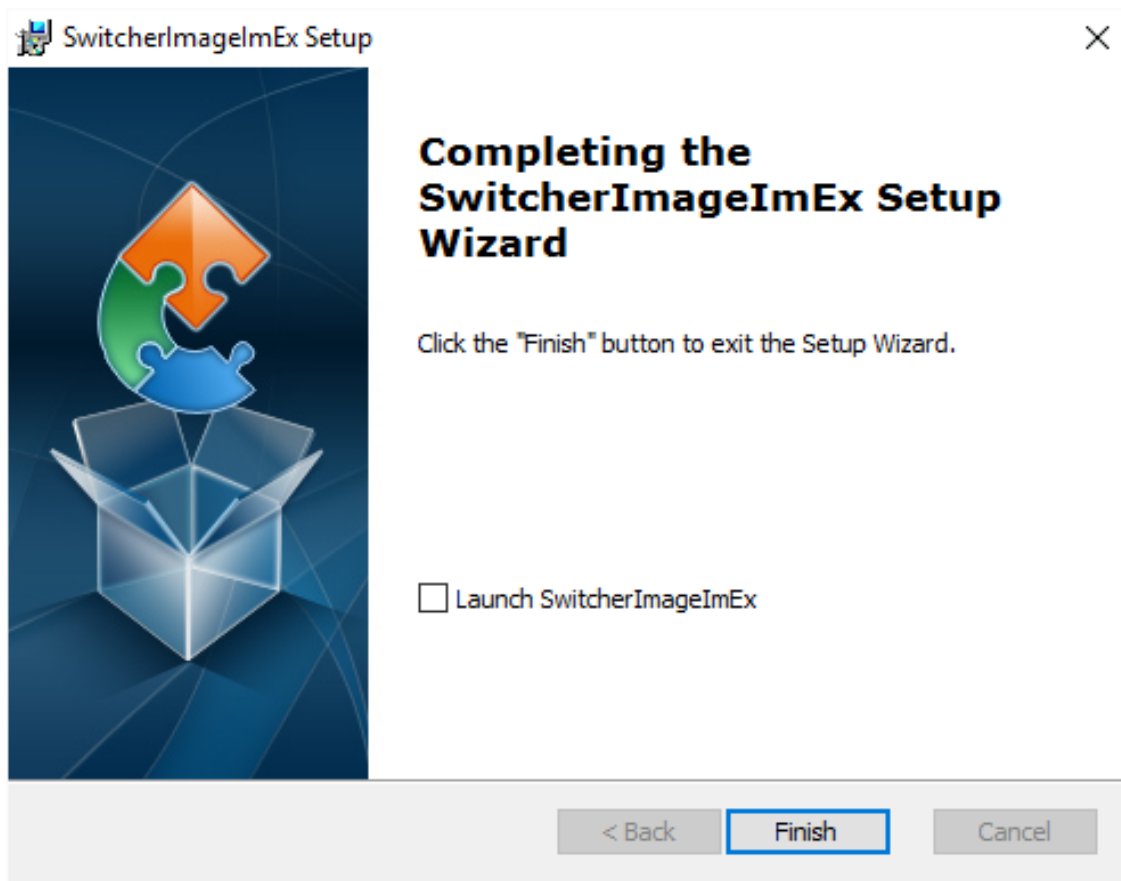

8. After the setup is finished, a shortcut will be created in Start Menu > Programs > datavideo > tools > SwitcherImageImEx

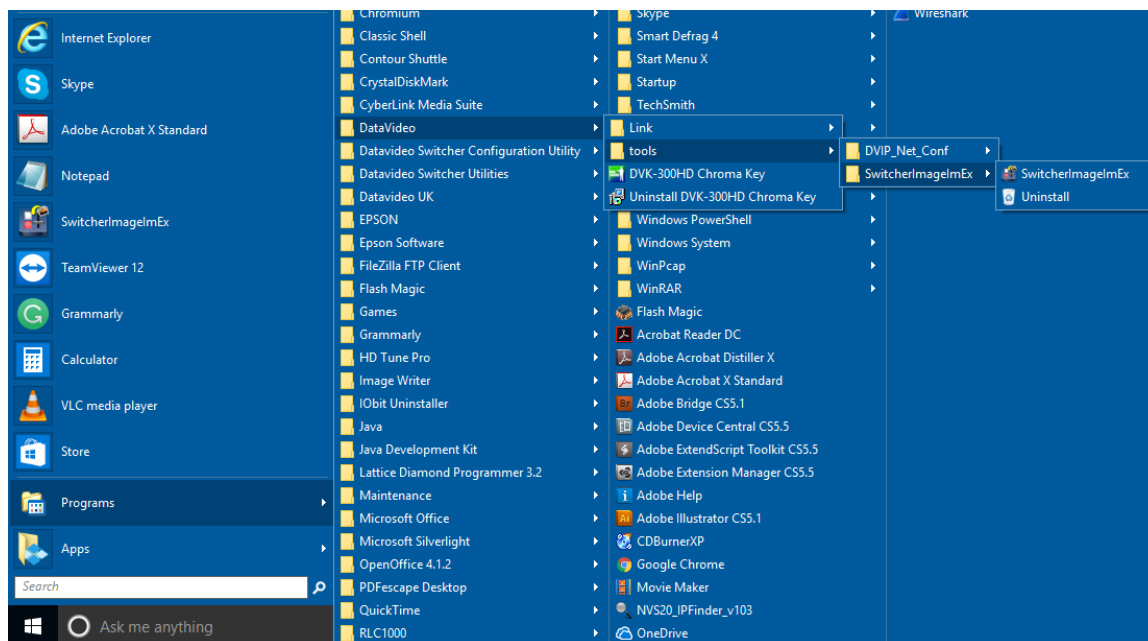

9. Click **SwitcherImageImEx** to open the program.

The **Switcher Image Import/Export software** has a built-in IP finder, which is designed for PC with multiple Ethernet cards or DHCP network environment. Please note IP finder can only find devices that are on the same network domain as the PC. If you cannot remember

your device IP, simply open the OSD menu and then go to the Setup sub menu to restore the default network settings. Upon launch of the **Switcher Image Import/Export software**, you will be prompted to select one Ethernet Interface Card.

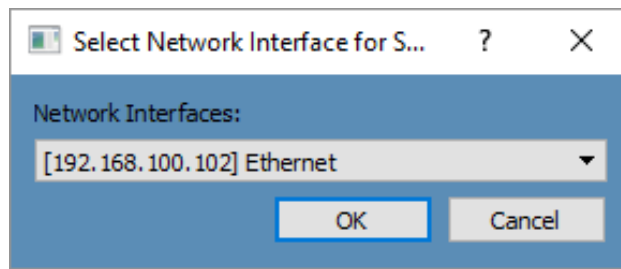

Once selected, click **OK** to start the scanning process.

Note: Please make sure the selected interface card is on the same network domain as the HS-3200 device.

Once the HS-3200 device is found, the software will connect with the switcher hardware over the IP set up described in the previous section. If the connection is successfully established, on the software user interface as shown in the diagram below, the **Connect Status** will show **“Connected”** (will display **Not Connected** if disconnected).

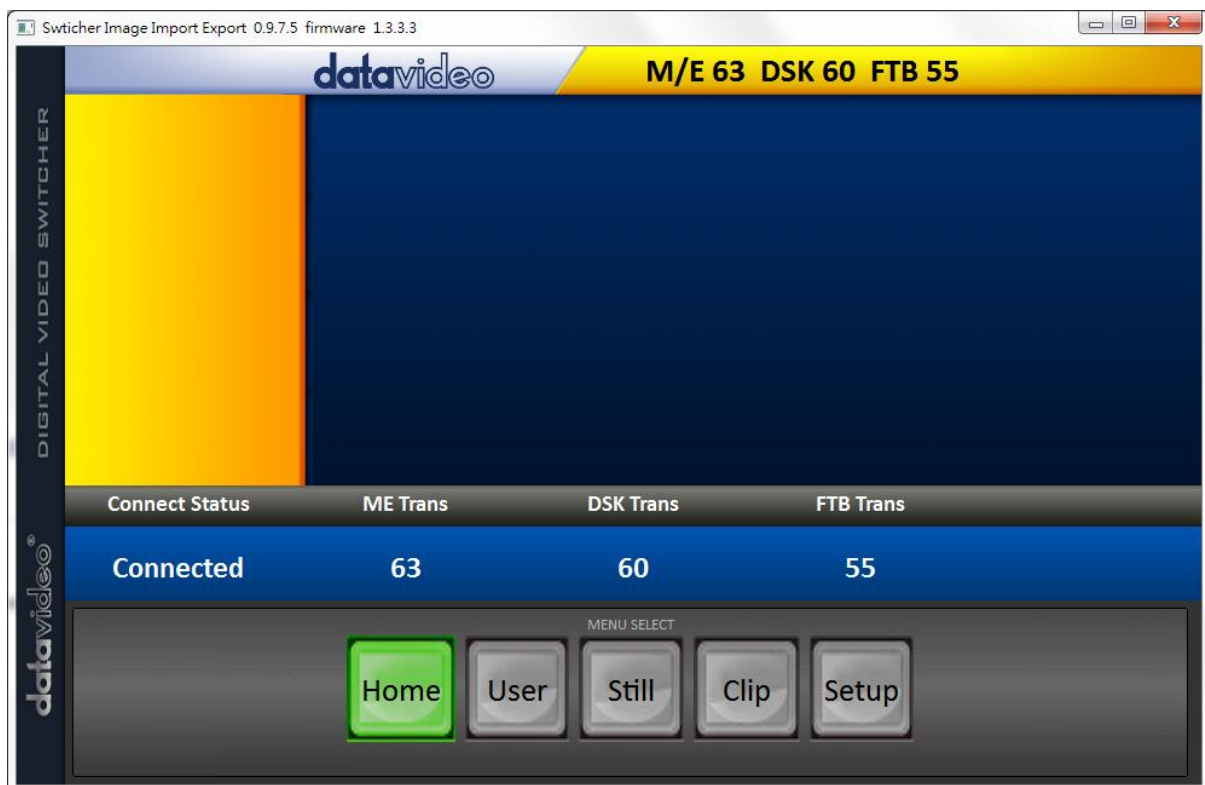

Router Based DHCP Setup

The computer software can also access the HS-3200 over an existing TCP/IP LAN type network. In order to initially set up the HS-3200, you may need the assistance of your local I.T. specialist to help with the network settings. To help guide you, we have included a simplified network setup example below, further advice may be available through your dealer locally or your Datavideo regional office.

To create this simple dedicated HS-3200 IP network you will need:

- An IP router which can assign/give IP addresses.
- Two RJ-45 patch leads.
- Windows 7/8/10 laptop or PC.
- The IP router Administrator login and password.
- The Datavideo Switcher Image Import/Export software.

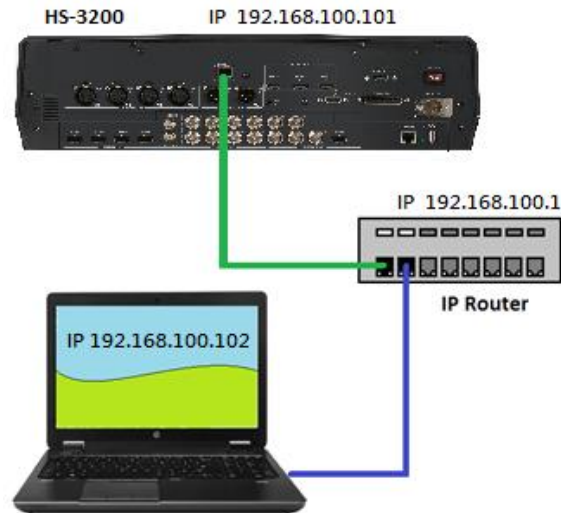
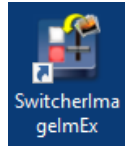

Instructions

1. First connect the router to the HS-3200 and the Windows computer using two RJ-45 patch leads.
2. Turn on the Windows computer and set it to **DHCP setup** within the **Windows Network and Sharing Centre**.
3. Now click the Windows start button and run the CMD prompt window.
4. At the command line > :_ type **IPCONFIG** and press enter.
5. The **DEFAULT GATEWAY** number displayed should be the router's current IP address.
6. Press the **MENU** button on the HS-3200 control panel to open the OSD menu on the connected Multiview monitor. Open the **Network** sub menu of the **Setup** menu and then change the **Addr Mode** to **DHCP** from the default **Static IP**. Move to the **SAVE** option and then press the **ENTER** button to save new settings.
7. Reboot the HS-3200 and after the machine is rebooted, open the **Network** sub menu by following the instructions outlined in the previous step. The **IP Addr** option should show an IP address assigned randomly by the router thus having identical network domain as the router. If you see an IP address of 0.0.0.0 in the **IP Addr** field, it is likely that the router requires longer time to assign an IP address to the connected devices. Close the **Network** sub menu and reopen after 30-60 seconds, you should be able to see the newly assigned IP address.
8. Now install the **Switcher Image Import/Export software** to the computer.

Setting the Target IP Address with the Switcher Image Import/Export Software

Click **Setup** button in the **MENU SELECT** pane and the current IP Network settings are shown alongside the software version.



If the network settings are wrong then you may not be able to access the HS-3200. Always keep a note of the last IP settings used and change these settings carefully to avoid problems.

Target IP address – This IP address is the location on the local network, or the internet, where the software can talk to the HS-3200. By clicking the **Target IP address** you can enter a new address, once entered click **Save Setup**. The next time the Image Import/Export Software is opened, it will try to contact the switcher on this new Target IP address.

Network – This option in the yellow menu column allows you to change the network options on the HS-3200. When delivered from the factory **the default static IP settings should be:**

Addr Mode: Static (a manually set IP address that does not change even after power cycling the HS-3200 unit)

Target IP address: 192.168.100.101

Network Mask: 255.255.255.0

Gateway: 192.168.100.1

DHCP Setup - If the IP set up method is changed to DHCP then each time the HS-3200 is started, it may be given a different IP address by the network. Only use this method if you know how to find the HS-3200 on the internal IP network. A device on the network (usually a router or server) will automatically assign an IP address to the HS-3200. The other settings such as IP address, Subnet Mask and Gateway may appear blank within the **Switcher Image Import/Export software** as these would be automatically set by network router/DHCP server.

The software supports multiple languages which are English, Traditional Chinese and Simplified Chinese.

Note: The latest software version can be downloaded from the product page. To update the software, it is recommended to remove the existing program first. Click “**Start Menu > Programs > datavideo > tools > Uninstall**” to remove the program. If the program is not removed, the user will be prompted that the PC already contains the same program during the reinstallation process. Click “**Remove**” to remove **SwitcherImageImEx** from your computer.

Chapter 4 OSD MENU

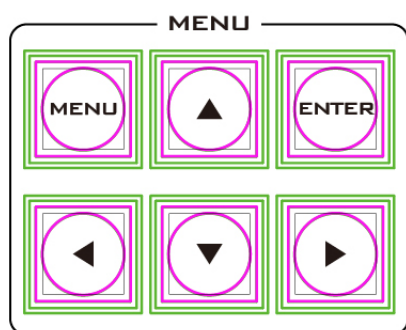

The switcher's OSD menu allows the user to perform several configurations of image effects, such as Picture-in-Picture, chroma key, subtitle overlay, still pictures and etc. The user can also configure the I/O by selecting different input and output options. In addition, in the setup menu, the user is allowed to set the menu color, size, position and language.

The OSD Menu can be opened in basic or advanced mode.

The basic mode is generally a condensed version of the advanced menu mode. The following sub-sections will show you the various options available in these two modes.

Overview

Main Options	Sub-Options	Parameters	
Start	Transition (Duration)	M/E	Mix Effect (0 - 9999 Default: 15)
		DSK	Downstream Key Effect (0 - 9999 Default: 15)
		FTB	Fade-to-Black Effect (0 - 9999 Default: 60)
	Type	DVE	
		Clip	
		Wipe	
		Mix	
	Wipe Effects	Wipe	Wipe Effect Presets (1 - 32 Default: 1)
		Soft	Border Softness (0 - 100% Default: 0%)
		Width	Border Width (0 - 100% Default: 1%)
	Border	Luma	Border Color Luma (0 - 100% Default: 100%)
		Sat	Border Color Saturation (0 - 100% Default: 80%)
		Hue	Border Color Hue (0 - 355 +/-5 Default: 0)
	Position	X	Horizontal Position (0 - 1600% Default: 0%)
		Y	Vertical Position (0 - 1600% Default: 0%)
Matte	Luma	Background Matte Luma (0 - 100% Default: 100%)	
	Sat	Background Matte Saturation (0 - 100% Default: 80%)	
	Hue	Background Matte Hue (0 - 355 +/-5)	
Keyer	Keyer	DSK 2 DSK 1 Key 4 Key 3 Key 2 Key 1	Keyer Selection (Default: Key 4)
	Keyer Ctrl	Chroma Luma Linear	Type of Keyer (Default: Linear)

		Select one	P-in-P Self Split	Self: One input keyer (Default) Split: Dual input keyer P-in-P window enable	
		Lift		Parameter for dark/black areas of the overall foreground key image, ranging from -100% to +100% (Default: 0%).	
		Gain		Parameter for light/white areas of the overall foreground key image, ranging from 0 to 16.0 (Default: 1.0).	
		Opac		Parameter for transparency of the overall foreground key image, ranging from 0% to 100% (Default: 100%).	
			Invert		OFF: Luma key removes black background by default ON: Luma key removes white background after INVERT is turned ON .
	Key Source	Bars Matte Flex Src Still 2 Still 1 Input 12 Input 11 Input 10 Input 9 Input 8 Input 7 Input 6 Input 5 Input 4 Input 3 Input 2 Input 1 Black			Key Source Selections (Default: Input 4)
		Fill		Fill Source Selection from Bars / Matte / Flex Src / Still 2 / Still 1 / Input 12 / Input 11 / Input 10 / Input 9 / Input 8 / Input 7 / Input 6 / Input 5 / Input 4 / Input 3 / Input 2 / Input 1 / Black (Default: Black)	
	Mask	Left		Left sets the left edge of the keyer mask (Default: 0%).	
		Right		Right sets the right edge of the keyer mask (Default: 0%).	
		Top		Top sets the top edge of the keyer mask (Default: 0%).	
		Bottom		Bottom sets the bottom edge of the keyer mask (Default: 0%).	
	Chroma	Keyer	DSK 2 DSK 1 Key 4 Key 3 Key 2 Key 1	Keyer Selection (Default: Key 4)	

	Key Source	Bars Matte Flex Src Still 2 Still 1 Input 12 Input 11 Input 10 Input 9 Input 8 Input 7 Input 6 Input 5 Input 4 Input 3 Input 2 Input 1 Black	Key Source Selections (Default: Input 4)
	CK Setup	CK Auto	Calculation of the best Hue & Luma values for the current Keyer source
		Hue	Parameter for color of the chroma key, ranging from 0 to 355 (Default: 110).
		Luma	Parameter for luma of the chroma key, ranging from 0 to 100% (Default: 80%).
		K Range	Setting the range of colors that match the background color to be keyed, ranging from 0 to 355 (Default: 160).
		K Fgnd	Adjusts the performance of the chroma key in dark or black areas, ranging from 0% to 100% (Default: 10%).
		K Bgnd	Adjusts the performance of the chroma key in light or white areas, ranging from K Fgnd value (min = 0) to 100% (Default: 20%).
		Hi-Light	Boosts the foreground key in high luminance area, ranging from 0 to 100% (Default: 0%).
		Lo-Light	Boosts the foreground key in low luminance area, ranging from 0 to 100% (Default: 0%).
		Bg-Supp	Bg-Supp turns ON/OFF background suppress (Default: OFF).
	Mask	Left	Left sets the left edge of the keyer mask (Default: 0%).
		Right	Right sets the right edge of the keyer mask (Default: 0%).
		Top	Top sets the top edge of the keyer mask (Default: 0%).
		Bottom	Bottom sets the bottom edge of the keyer mask (Default: 0%).
P-in-P	Keyer	Key 1 Key 2 Key 3 Key 4 Flex PinP 1 Flex PinP 2	Selection of PIP windows

		Flex PinP 3 Flex PinP 4		
	Position	X	Horizontal PIP Position (-100 - 100% Default: -20%)	
		Y	Vertical PIP Position (-56 - 56% Default: 10%)	
		Size	PIP Size (2 - 100% Default: 40%)	
	Border	Border Off Normal Shaded 3D Bevel 3D Bevel Shade Dual Bevel Bevel Flat Flat Bevel 3D Glass Glass Shaded Dual Glass Glass Flat Flat Glass	Selection of border style (Default: Normal)	
		Luma	PIP Border Luma (0 - 100% Default: 100%)	
		Sat	PIP Border Color Saturation (0 - 100% Default: 80%)	
		Hue	PIP Border Color Hue (0 - 355 +/-5 Default: 0)	
		Width	PIP Border Width (0 - 100% Default: 2%)	
		Soft	Distinctiveness of Border Edge (0 - 100% Default: 0%)	
		Opac	Border transparency (0 - 100% Default: 100%)	
		Shade Matte	Luma	Shade Matte Luma (0 - 100% Default: 100%).
			Sat	Shade Matte Saturation (0 - 100% Default: 80%).
			Hue	Shade Matte Color (0 - 355 +/-5 Default: 60).
	Shade Soft		This blurs or softens the Shade Matte area (0 - 100% Default: 2%).	
	Shade Pos		Sets position of the boundary line between Shade Matte and Border Matte (0 - 100% Default: 50%).	
	Direction		Direction of light source (0 - 355 +/-5 Default: 35).	
	Crop	Left	Left Edge of the Crop (0 - 100% Default: 0%).	
		Right	Right Edge of the Crop (0 - 100% Default: 0%).	
		Size	Size of the Crop (0 - 100% Default: 0%).	
		Top	Top Edge of the Crop (0 - 100% Default: 0%).	
		Bot	Bottom Edge of the Crop (0 - 100% Default: 0%).	
Flex Src	Flex Src Bgnd	Bars Matte Flex Src	Selection of Flex Screen sources and default is Black.	
	P-in-P 1 Src	Still 2		
	P-in-P 2 Src	Still 1		
	P-in-P 3 Src	Input 1-12		
	P-in-P 4 Src	Black		

	Quick	Quick 0 Quick 1 Quick 2	Selection of Flex Screen layouts.
Inputs	Input	Input 1-12	Selection of an input to set the mode.
		Mode	Four input modes are Live, Freeze, Still and Clip (Default is Live).
	Proc Amp	Black	Black level (0 - 100% Default: 0%)
		White	White level (0 - 100% Default: 100%)
		Chrom	Chroma level (0.0 - 16.0 Default: 1.0)
	Audio	Gain	Audio volume of a selected video input (-60 - 24 dB Default: 0 dB).
		Delay	Audio delay of a selected video input (0 - 375 ms Default: 0 ms).
Crosspoint	Input 1-12 Off	Assign the selected input source to an input button (Default is Input 1).	
Audio XPT	Input 1-12 Off	Associate the audio component of a selected input source to an input button (Default is off).	
Outputs	Output	SDI 1	Flex Src Still 2 Still 1 Input 1 – 12 CLN PVW (Clean PVW) CLN PGM (Clean PGM) PG + DSK PVW PGM MultiV (Multi view) (SDI default: PGM / HDMI default: MultiV)
		SDI 2	
		SDI 3	
		SDI 4	
		SDI 5	
		HDMI	
	Multiviewer	AutoNum	Auto number input labels (ON/OFF (Default))
		Label Inf	Input label is followed by information which describes the input as still, live or frozen image (ON/OFF (Default))
		Trns Lab	Turn the background of the label from a solid colour to transparent (ON/OFF (Default))
		Mode	Multiviewer Modes 1 – 4 (Default: 3)
	Tally Mode	Audio Mixer	Select either the audio mixer input or the tally light connection.
		Normal	
	GPI Out	ON/OFF	GPI Enable/Disable (Default: OFF)
		Mode	Level/Pulse (Default: Pulse)
		Width	Pulse width (Default: 1)
		Input 1-12	GPI-out assignment
		Delay	0-99 (Default: 0)
Audio	Audio	Mode	Turns ON/OFF embedded component at SDI-out and HDMI-out.
		Src	Selection of audio out source: PGM Audio (Default) / Follow / Input 1-12
	PGM Audio	Mode	Audio transition style: X Fade / V Fade (Default)
		Main Gain	Audio volume of a selected video input Range: -60 - 24 (dB) with default = 0 dB

		Main Delay	Audio delay of a selected video input Range: 0 - 375 ms with default = 0 ms
	Analog Out	Src	Selection of audio out source: PGM Audio (Default) / Follow / Input 1-12
		Gain	Audio out volume Range: -60 - 24 (dB) with default = 0 dB
		Delay	Audio out delay Range: 0 - 375 ms with default = 0 ms
Files – Stills	Load Still	Load	Pressing this button loads the selected still picture source
		Still Num	0-500 (Default = 1)
		Destination	Still 1 (Default) Still 2 Input 1 – 12
		Thumbnail Picture - 1	Preview of the previous image
		Thumbnail Picture	Preview of the image to be loaded
	Save Still	Thumbnail Picture + 1	Preview of the next image
		Save	Pressing this button saves the selected still picture
		Source	Still 1 (Default) Still 2 Input 1 – 12
	Grab Still	Still Num	0-500 (Default = 1)
Grab		Press this button to grab the current program view	
Grab Still	Grab Destination	Still 1 (Default) Still 2 Input 1 – 12	
	Load Mem	Memory	Memory Selection from 1 to 999 (Default: 1)
Save Mem		Load	Selection of this button loads the selected memory
	Save Mem	Memory	Memory Selection from 1 to 999 (Default: 1)
Save Mem		Save	Selection of this button saves to the selected memory
	Files – Clip	Load Clip	Load
Clip Memory Location			Memory locations from 0 to 999 (Default = 0)
Clip Settings			Sets the clip's start and end frames and the transition frame. Start Frm End Frm Mid Frm
Thumbnail Clip - 1			Preview of the previous clip
Thumbnail Clip			Preview of the clip to be loaded
Thumbnail Clip + 1			Preview of the next clip
Clear Clip			Clear the loaded clip
Delete Clip			Remove the clip from the memory location
Setup	Standard	1080p59.94	Resolution Selection 1080p/50/59.94/60 1080i/50/59.94/60

		720p/60/59.94/50
	Save Setup	Saves the selected resolution
Level	EBU SMPTE AUTO (Default)	Audio standards
Menu Mode	Advanced	Full (Default)
	Basic	Reduced
Menu Pref	Blue / Grey	Selection of menu color
	Transp	Menu transparency level of 0/1/2 (Default: 1)
Menu Pos	Bottom (Default) Right Left Top Centre	This option sets the menu position
Keyboard	Brightness	1 – 5 (Default: 3)
Auto Save	ON / OFF	Automatically saves the last settings before the machine is shut down; once turned ON auto save also occurs upon every Still Load.
Factory Def	Restore	Factory Default Reset loads the default configuration from memory point 0 for all configuration options except for the Setup.
	Restr Names	Resets the Multiviewer labels to the default settings
Language	English Traditional Chinese Simplified Chinese	
Network	Addr Mode	DHCP(Default) / Static
	IP Addr	
	Network Mask	
	Cancel / Save	
	Network Def	Yes / No
Software	Upgrade	This starts the FW upgrade process Please refer to the Firmware Upgrade section for the USB firmware update process.

4.1 Start

Advanced mode

Start	Transition	M/E	15	DSK	15	FTB	60
	Type	MIX					
	Wipe Effects	Wipe	1	Soft	0%	Width	1%
	Border	Luma	100%	Sat	80%	Hue	0
	Position	X	0%	Y	0%		
	Matte	Luma	100%	Sat	80%	Hue	0

Basic mode

Start	Transition	M/E	15	DSK	15	FTB	60
	Wipe Effects	Wipe	1	Soft	0%	Width	1%

Transition

The **Transition** option allows the user to set the transition duration, in frames, for switching to the PGM view when using the **AUTO**, **DSK** and **FTB** buttons.

For example, if the **M/E** is set to a value of 50, then the transition will take effect over a period of 50 frames or roughly 2 seconds. When the **AUTO button** is pressed, the transition will take the current M/E value defined by the user setting.

Type

The HS-3200 provides three major types of transition effect, which are **DVE (3D)**, **MIX**, **WIPE (2D)** and **Clip**. Please note in addition to selecting the transition effect on the OSD menu, you can also press **MIX button**, **WIPE/DVE button** or **CLIP button** to enable the respective transition effects.

- If **DVE** is selected, select the corresponding 3D WIPE effect by pressing the DVE buttons on the control panel. These DVE buttons correspond to WIPE number 100, 101 and 102 on the OSD menu.
- If **MIX** is selected, set the transition duration in “**M/E**.”
- If **WIPE** is selected, set the relevant WIPE settings in “**WIPE Effects**.”
- If **Clip**, also known as the **Stinger Effect**, is selected, please load the clip in “**User Mem.**”

Wipe Effects

In “**WIPE Effects**,” the user is allowed to select the Wipe style and configure the wipe’s border softness and width.

- **Wipe** – Selection of a WIPE effect from a set of 32 WIPE transition effects.
- **Soft** – A low value results in a solid edge and a high value gives a soft diffused edge.
- **Width** – A low value results in a thin edge and a high value gives a wide edge.

WIPE Border

In this sub-option, the user will be allowed to fine-tune the border color by adjusting the **Luma**, **Saturation** and **Hue** values.

Note: Enable the WIPE border by setting the border width (Width) to a value greater than 0. The WIPE border is disabled when the border width is set to 0.

Position

Position allows the user to adjust the center position of certain wipes (e.g Circle & Ellipse). **X** represents the horizontal position and **Y** is the vertical position.

Horizontal Position (X)

Positive value moves the wipe center to the right.

Negative value moves the wipe center to the left.

Zero value positions the wipe center at the screen center

Vertical Position (Y)

Positive value moves the wipe center up.

Negative value moves the wipe center down.

Zero value positions the wipe center at the screen center.

Matte

The user can open the Matte view by pressing the **BLK/MATTE** button of the **Program** and **Preset** button rows. The color of the Matte is configurable in this sub-option by adjusting **Luma**, **Saturation** and **Hue**.

For **Hue** value, **Red** is 0, **Green** is approximately 120 and **Blue** is approximately 240. For secondary colors, **Yellow** is approximately 60, **Cyan** is approximately 180 and **Violet** is approximately 300.

The **Sat** or **Saturation value** refers to the intensity of the color selected in **Hue**. As the saturation increases, the color appears to be more pure. As the saturation decreases, the color appears to be more washed-out or pale.

The **Luma value** relates to how bright or dark the selected color or hue is. The higher the **Luma** value, the brighter the color selected in **Hue**.

4.2 Keyer

Keyer of the HS-3200 provides the user with the capability of image keying. In this option, the user will be able to configure the available six keyers, which can be activated by pressing the corresponding keyer buttons on the control panel.

Advanced mode

Keyer	Keyer	Key 4		
	Keyer Ctrl	Linear	Self	

	Lift	0%	Gain	1.0	Opac	100%
Key Source	Input 4		Fill	Black		
Mask	Left	0%	Right	0%		
	Top	0%	Bot	0%		

Keyer

The HS-3200 offers the user 6 keyer options, which are **Key 1**, **Key 2**, **Key 3**, **Key 4**, **DSK 1** and **DSK 2**. Once configured, the keyers can be enabled by pressing the corresponding keyer buttons on the switcher's control panel.

Keyer Control

There are three keying modes available: **Linear**, **Luma**, and **Chroma**.

Linear keying mode is usually chosen for sharp images. For non-sharp images, please select **Luma** keying. **Chroma** keying mode allows you to remove the green or blue backdrop from the image.

After the keying mode is chosen, select **Self** if only one source is required for the keyer, which is Key source. Select **Split** if two sources are required for the keyer, which are Key and Fill sources. You can also select **P-in-P** to apply the keying effect to the PIP window.

If **Luma** keying is selected, the key image is configured by adjusting **lift**, **gain** and **opacity** parameters.

Lift adjusts the dark/black areas of the key image. **Reducing the value of Lift** will make dark areas of the key image more transparent. The background image will be showing only through the transparent areas.

Gain adjusts the light/white areas of the key image. **Increasing the value of Gain** will make light areas of the key image more solid. The background image will be showing only through the transparent areas.

Opac adjusts the transparency of the overall foreground key image. **Increasing the value of Opacity** will make the overall key image less transparent.

Please note:

If Chroma is selected, adjust the Chroma Keyer parameters in the Chroma option.

If P-in-P is selected, adjust its parameters in the P-in-P option.

For example, if the user selects **Key 1** → **Chroma** → **P-in-P**, you will then be able to apply the chroma key effect to the P-in-P window by configuring the respective chroma keyer parameters in the **Chroma** option.

In the example below, after Keyer 1 is configured, by pressing the **Key 1** button on the switcher's control panel, the user will thus be able to enable the P-in-P window on the respective display monitor with the chroma key effect applied.

Keyer	Keyer	Key 1		
	Keyer Ctrl	Chroma	Self	
		Lift 0%	Gain 1.0	Opac 100%
	Key Source	Input 1	Fill Black	Invert Off
	Mask	Left 0%	Right 0%	
		Top 0%	Bot 0%	

Key Source

This option allows the user to assign the key source; various options are listed below:

- Bars: Color bars
- Matte: A configurable color screen and the Matte value can be set in **Matte** option of the **Start** menu
- Flex Src: Flex button source
- Still 2: Still picture loaded to Still 2 button
- Still 1: Still picture loaded to Still 1 button
- Input 12: Image source loaded to input button 12
- Input 11: Image source loaded to input button 11
- Input 10: Image source loaded to input button 10
- Input 9: Image source loaded to input button 9
- Input 8: Image source loaded to input button 8
- Input 7: Image source loaded to input button 7
- Input 6: Image source loaded to input button 6
- Input 5: Image source loaded to input button 5
- Input 4: Image source loaded to input button 4
- Input 3: Image source loaded to input button 3
- Input 2: Image source loaded to input button 2
- Input 1: Image source loaded to input button 1
- Black: Black Screen

Fill Source

This sub-option allows the user to assign the fill source; various options are listed below:

- Bars: Color bars
- Matte: A configurable color screen and the Matte value can be set in **Matte** option of the **Start** menu
- Flex Src: Flex button source
- Still 2: Still picture loaded to Still 2 button
- Still 1: Still picture loaded to Still 1 button
- Input 12: Image source loaded to input button 12
- Input 11: Image source loaded to input button 11
- Input 10: Image source loaded to input button 10
- Input 9: Image source loaded to input button 9

- Input 8: Image source loaded to input button 8
- Input 7: Image source loaded to input button 7
- Input 6: Image source loaded to input button 6
- Input 5: Image source loaded to input button 5
- Input 4: Image source loaded to input button 4
- Input 3: Image source loaded to input button 3
- Input 2: Image source loaded to input button 2
- Input 1: Image source loaded to input button 1
- Black: Black Screen

Invert

Configure the luma key color

OFF: Luma key removes black background by default.

ON: Luma key removes white background after **INVERT** is turned **ON**.

Mask

The Mask feature basically shrinks the source image by removing borders of the final image. In this option, the user is allowed to configure the Mask in chroma, luma or linear mode by adjusting **Left**, **Right**, **Top** and **Bottom** parameters.

- **Left** – Left sets the left edge of the keyer mask.
- **Right** – Right sets the right edge of the keyer mask.
- **Top** – Top sets the top edge of the keyer mask.
- **Bottom** – Bottom sets the bottom edge of the keyer mask.

4.3 Chroma

The Chroma Keyer of the HS-3200 removes the green background of the overall image.

Configure the corresponding parameters in this option if **Chroma** is selected in **Keyer**.

Advanced mode options

Chroma	Keyer	Key 4					
	Key Source	Input 4					
	CK Setup	CK Auto	Hue	110	Luma	80%	
		K Range	160	K Fgnd	10%	K Bgnd	20%
		Hi-Light	0%	Lo-Light	0%	Bg-Supp	OFF
	Mask	Left	0%	Right	0%		
		Top	0%	Bot	0%		

Keyer

First of all, select the **Keyer** (**Key 1**, **Key 2**, **Key 3**, **Key 4**, **DSK 1** or **DSK 2**) that you would like to apply the chroma key effect to and then select one **Key Source** from all available Key Sources listed below.

Key Source

This sub-option allows the user to assign a key source to the keyer selected; various options are listed below:

- Bars: Color bars
- Matte: A configurable color screen and the Matte value can be set in **Matte** option of the **Start** menu
- Flex Src: Flex button source
- Still 2: Still picture loaded to Still 2 button
- Still 1: Still picture loaded to Still 1 button
- Input 12: Image source loaded to input button 12
- Input 11: Image source loaded to input button 11
- Input 10: Image source loaded to input button 10
- Input 9: Image source loaded to input button 9
- Input 8: Image source loaded to input button 8
- Input 7: Image source loaded to input button 7
- Input 6: Image source loaded to input button 6
- Input 5: Image source loaded to input button 5
- Input 4: Image source loaded to input button 4
- Input 3: Image source loaded to input button 3
- Input 2: Image source loaded to input button 2
- Input 1: Image source loaded to input button 1
- Black: Black Screen

CK Setup

In this sub-option, the user will be able to find all the parameters needed to perform chromakeying of the green or blue backdrop.

CK Auto: This function automatically calculates the best Hue & Luma values for the current Keyer source. After applying the CK Auto effect, the result can be fine-tuned by adjusting the Luma and Hue values.

Hue: This parameter adjusts the color of the chroma key. A typical green screen value will be around 120. Blue screen value will be around 240.

Luma: This parameter adjusts the luma value of the chroma key

K Range (Key Range): Key Acceptance sets the range of hues or colors (0 – 360 degrees) that closely match the background color to be keyed. The user can start with a value of 120 degrees and this value can be fine-tuned up or down depending on the setup of the green or blue screen studio.

K Fgnd (Key Foreground): **Key Foreground** adjusts the performance of the chroma key in light or white areas. Apply more **Key Foreground** if the light areas are becoming too transparent.

K Bgnd (Key Background): **Key Background** adjusts the performance of the chroma key in dark or black areas. Apply more **Key Background** if the dark areas are becoming too transparent.

Hi-Light: Hi-light boosts the foreground key in high luminance area.

Lo-Light: Lo-light boosts the foreground key in low luminance area.

Bg-Supp: **Background Suppress** removes the Luma (Brightness) of the background from the final image. **Bg-Supp** turns ON/OFF background suppression.

Mask

The Mask feature basically shrinks the camera image by removing the borders from the final image. This feature allows the user to configure the Mask in chroma, luma or linear mode.

- **Left** – Left sets the left edge of the keyer mask.
- **Right** – Right sets the right edge of the keyer mask.
- **Top** – Top sets the top edge of the keyer mask.
- **Bottom** – Bottom sets the bottom edge of the keyer mask.

4.4 P-In-P

The **P-in-P** option allows the user to adjust all related P-in-P parameters. Use this option to configure your PIP window if **P-in-P** is selected in the **Keyer Ctrl** sub-option of the **Keyer** option.

Note: The P-in-P image source can only be selected in **Key Source** option of the **Keyer Sub Menu**.

Advanced mode options

P-in-P	Keyer	Key 1			
	Position	X	-20%	Y	10%
	Border	Normal			Size 40%
		Luma	100%	Sat	80%
		Width	2%	Soft	0%
					Hue 0
	Shade Matte	Luma	100%	Sat	80%
		Shade Soft	2%	Shade Pos	50
					Direction 35
	Crop	Left	0%	Right	0%
		Top	0%	Bot	0%
					Size 0%

Keyer

In this sub-option, the user will be allowed to select and configure the PIP window from the following list below. Please note that Keyers 1-4 are active for PIP configuration only if P-in-P is selected for the respective keyer.

- **Key 1**
- **Key 2**

- **Key 3**
- **Key 4**
- **Flex PinP 1**
- **Flex PinP 2**
- **Flex PinP 3**
- **Flex PinP 4**

Position

The user can adjust the P-in-P window position by adjusting values of **X**, **Y** and **SIZE**, where X is the horizontal position, Y is the vertical position and Size is the PIP screen size.

X-Value Positive value: position the P-in-P window to the right.
 Negative value: position the P-in-P window to the left.
 Zero value: Position the P-in-P window at the center.

Y-Value Positive value: move the P-in-P window up.
 Negative value: move the P-in-P window down.
 Zero value: Position the P-in-P window at the center.

Size Ranges from 0 to 100 with 1% being the smallest and 100 being the largest. So 50% would represent a P-in-P window which is half the size of the background image. 100% would see the PIP image totally cover the background image unless offset to one side.

Border

The user is also allowed to add borders to the PIP window and the HS-3200 offers various border styles listed as follows:

- Border Off
- Normal
- Shaded*
- 3D Bevel**
- Bevel Shaded*
- Dual Bevel**
- Bevel Flat**
- Flat Bevel**
- 3D Glass**
- Glass Shaded**
- Dual Glass**
- Glass Flat**
- Flat Glass**

****See Shade Matte/Hue for dual color border setting.***

*****See Shade Matte/Direction for border shadow setting.***

To turn the Border off, simply select the option “Border OFF.”

In addition to assigning a style to the border, the user is also allowed to set border color by adjusting **Luma**, **Saturation** and **Hue** values. **Luma** and **Saturation** range from 0 to 100%. **Hue** value ranges from 0 to 355. The borders can also be widened or narrowed by adjusting **Width**. Please note that a width of zero (0) will turn the PIP border off.

Opac adjusts the transparency of the border, ranging from 0% to 100%

Softness defines the distinctiveness of the border edge. A low value results in a solid border edge and a high value gives a soft diffused border.

Shade Matte (Dual Color Border)

In order for the **Shade** effect to work, **Shaded Border (Dual Color)** must be selected first as the **Border** value – see the previous section **Border**. **Shade Matte** is determined by the inner border. The boundary between the normal border matte and the shade matte can be determined by adjusting the **Shade Position** parameter.

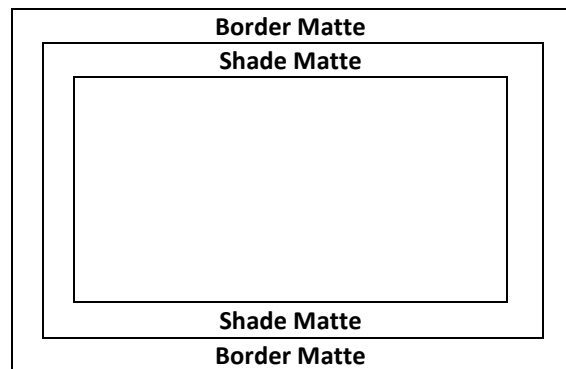

Luma, Sat and Hue

The color of the **Shade Matte** can also be controlled by adjusting the **Hue**, **Sat** and **Luma** values.

For **Hue** value, **Red** is 0, **Green** is approximately 120 and **Blue** is approximately 240. For secondary colors, **Yellow** is approximately 60, **Cyan** is approximately 180 and **Violet** is approximately 300.

The **Sat** or **Saturation value** refers to the intensity of the color selected in **Hue**. As the saturation increases, the color appears to be more pure. As the saturation decreases, the color appears to be more washed-out or pale.

The **Luma value** relates to how bright or dark the selected color or hue is. The higher the **Luma** value, the brighter the color selected in **Hue**.

Shade Softness, Shade Position and Direction

The **Shade Matte** can be further configured by adjusting its **softness (Shade Soft)** and **width (Shade Pos)**.

Shade Soft

This blurs or softens the **Shade Matte** area.

Shade Position

The position of the boundary line between **Shade Matte** and **Border Matte** is controlled by the **Shade Pos** value.

Increasing this value moves the boundary line such that the **Shade Matte** occupies less of the width of the border. Decreasing this value moves the boundary line such that the **Shade Matte** occupies more of the overall border width. When this value is 0, the **Shade Matte** occupies all of the border width.

Note: You will see dual colors only if options “Shaded” and “Bevel Shaded” are selected.

Direction

Direction sets the direction of the light source with the value of parameter ranging from 0 to 355. The default is 35, which indicates a direction of North East. You will see the border’s color shadow changes as the Direction value is changed. The directions that specific parameter values correspond to are listed as follows:

- 0: North
- 90: East
- 180: South
- 270: West

Crop

The PIP image crop can be adjusted by modifying the following parameters:

- **Left** – Adjusts the position of the left edge of the PIP image.
- **Right** – Adjusts the position of the right edge of the PIP image.
- **Size** – Adjusts the PIP image crop size.
- **Top** – Adjusts the position of the top edge of the PIP image.
- **Bot** – Adjusts the position of the bottom edge of the PIP image.

4.5 Flex Src

The Flex™ output allows the user to show a variety of sources at the same time. These image sources are fed as one combined image to the Program and Preset outputs.

The Flex™ output consists of one background image and four smaller source images overlapped on the background image in four separate individual PIP windows.

Flex Src	Flex Src Bgnd	Black		
	P-in-P 1 Src	Black		
	P-in-P 2 Src	Black		
	P-in-P 3 Src	Black		
	P-in-P 4 Src	Black		
	Quick	Quick 0	Quick 1	Quick 2

Flex Screen

To set the source of input for the respective FLEX windows, open the OSD menu and select FLEX Src. On the sub-menu that opens, you will be able to see the following options allowing you to select the image sources to be displayed in the FLEX windows.

- Flex Src Bgnd: The background image is the image on which the FLEX windows are placed.
- P-in-P 1 Src corresponds to the image displayed in FLEX window 1.
- P-in-P 2 Src corresponds to the image displayed in FLEX window 2.
- P-in-P 3 Src corresponds to the image displayed in FLEX window 3.
- P-in-P 4 Src corresponds to the image displayed in FLEX window 4.

The available sources of inputs are listed as follows:

- Black: Black Screen
- Input 1: Image source loaded to input button 1
- Input 2: Image source loaded to input button 2
- Input 3: Image source loaded to input button 3
- Input 4: Image source loaded to input button 4
- Input 5: Image source loaded to input button 5
- Input 6: Image source loaded to input button 6
- Input 7: Image source loaded to input button 7
- Input 8: Image source loaded to input button 8
- Input 9: Image source loaded to input button 9
- Input 10: Image source loaded to input button 10
- Input 11: Image source loaded to input button 11
- Input 12: Image source loaded to input button 12
- Still 1: Still picture loaded to Still 1 button
- Still 2: Still picture loaded to Still 2 button
- Flex Src: Flex button source
- Matte: A configurable color screen and the Matte value can be set in **Matte** option of the **Start** menu
- Bars: Color Bars

Quick

The HS-3200 offers the user three FLEX Screen layouts which can be selected in the **QUICK** option. The respective **default** layouts are shown in the diagrams below.

Quick 0

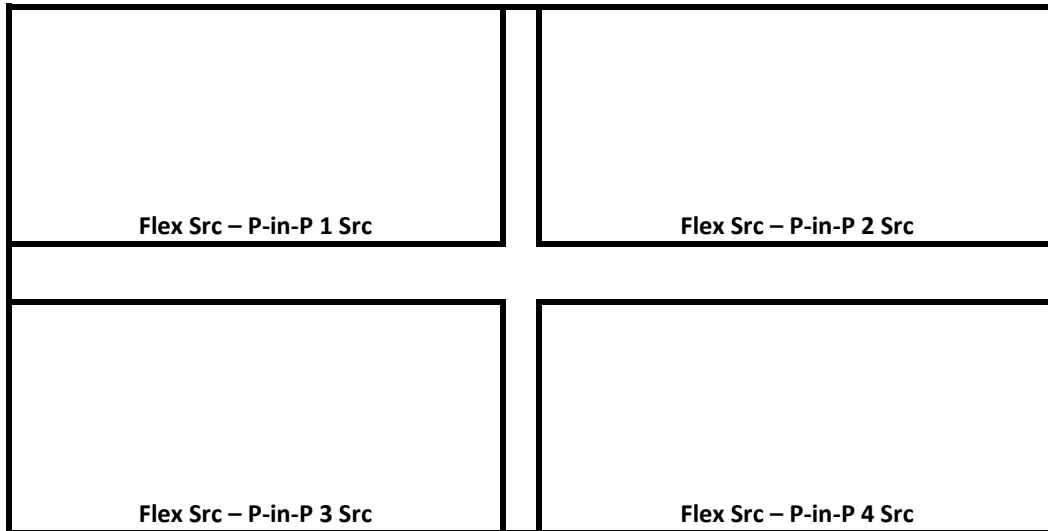

Quick 1

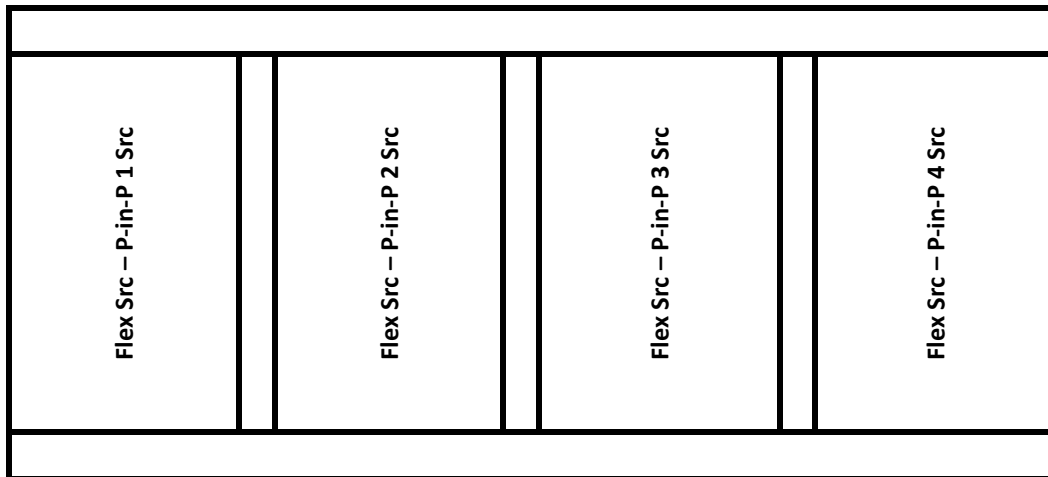

Quick 2

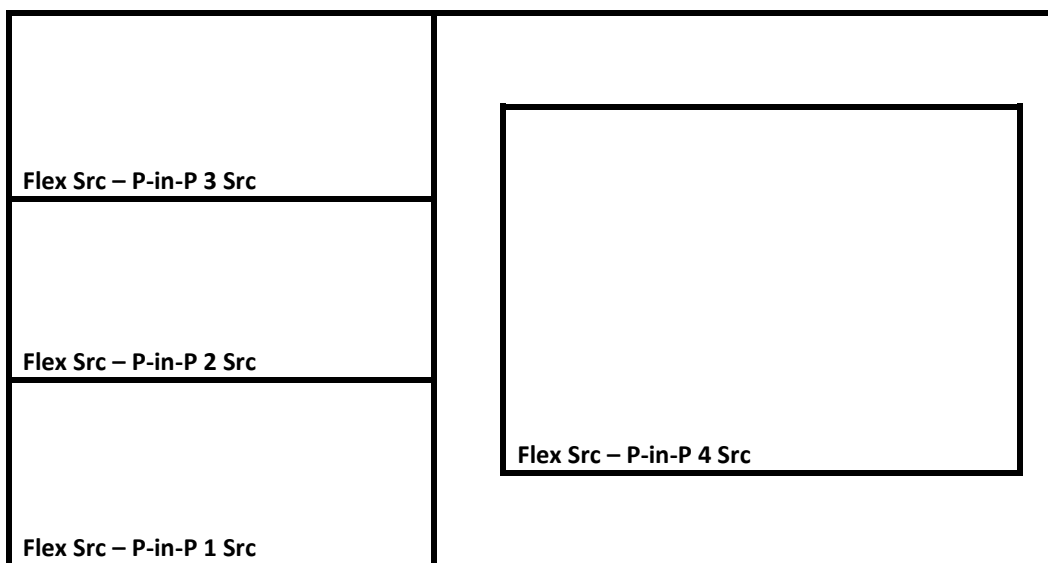

Please note that positions of these PIP windows on the FLEX screen can be changed by adjusting the **x-y coordinates** in the **P-in-P** option. In addition, the user is also allowed to adjust the size of the FLEX window, enable/disable the window's border, set the border color, and crop the window image.

After the FLEX source is properly configured, the user can activate the view on either the Program or Preset screen by pressing the **SHIFT** key followed by the **3/FLEX** button along the Program or Preset row.

Note that the Flex Src window has an allowable size of up to 1080p full screen. If exceeded, one of the Flex Src windows will not be able to display image correctly.

4.6 Inputs

This feature allows the user to select the mode of the selected input and then configure the input color by adjusting its **Black Level**, **White Clip** and **Chroma Gain** parameters. In addition, the Crosspoint function allows the user to shuffle the contents of Inputs 1-12 without changing the physical connections at the back of the machine.

Advanced mode options

Inputs	Input	Input 1	Mode	Live	
	Proc Amp	Black 0%	White 100%	Chrom 1.0	
	Audio	Gain 0 dB	Delay 0 ms		
	Crosspoint	Input 1			
	Audio XPT	Off			

Input

In this option, you will be allowed to set the mode of display in the respective Input windows of the Multiview display. First select the input that you would like to configure and then for each selected input, set the mode of input by selecting one of the modes listed as follows:

- Still – Displays the still picture loaded into Inputs 1-12 in the respective input window.
- Freeze – Freezes the current video played in the Input window.
- Live – Live view or video display in the Input window.
- Clip – Display of the clip loaded into Inputs 1-12 in the respective input window.

Proc Amp

Proc Amp allows the user to configure the input color by adjusting its Black Level (0 – 100%), White Clip (0 – 100%) and Chroma Gain (0 – 16) parameters.

Audio

Gain (-60 – 24 dB): adjustment of the input audio volume for a particular selected video input.

Delay (0 – 375 ms): sets the delay of the audio component of a particular selected video input.

Crosspoint

The crosspoint function allows the user to shuffle the contents of Inputs 1-12 without changing the physical connections at the back of the machine. For example, the user is allowed to assign the input 2 video source to input 1, after which the input 2 video will be displayed on the input 1 window. Select OFF if you would like to disable the input port.

- Input 1-12 (buttons)
- OFF

Audio XPT

The Audio XPT feature allows the user to associate the audio component of any input source to any of the input buttons (1 – 12), thus cross assigning audio input channels to program/preset row buttons.

Note: If you associate one video input channel to more than one program/preset row buttons, you will only see the input video correctly displayed on the video channel window associated with the first program/preset row button that you assign the video input channel to and the rest of the video channel windows will display corrupted images. To avoid this, make sure your XPT setting is configured to **one-input-to-one-button** configuration.

For example, if you assign video input channel 1 to button 2 of the program row, remember to swap the original video input channel associated with program button 2 with video input channel 1.

4.7 Outputs

This option allows the user to configure various output settings such as video output, Tally mode and GPI connection.

Advanced mode

Outputs	Output	Sdi 1	Pgm	Sdi 2	Input 1	Sdi 3	PVW
		Sdi 4	CLN PGM	Sdi 5	PG+DSK		
		HDMI	MultiV				
	Multiviewer	AutoNum	Off	Label Inf	Off	Trns Lab	Off
		Mode	3				
	Tally Mode		Normal				
	GPI Out		Off	Mode	Pulse	Width	1
			Input 1	Delay	0		

Basic mode

Outputs	Output	Sdi 1	Pgm	Sdi 2	Input 1	Sdi 3	PVW
		Sdi 4	CLN PGM	Sdi 5	PG+DSK		
		HDMI	MultiV				
	Multiviewer	AutoNum	Off	Label Inf	Off	Trns Lab	Off
		Mode	4				

Outputs

In general, the HS-3200 offers 6 output ports (**SDI 1 – 5/HDMI**) and all output ports can be configured to output one of the following:

- Flex Src
- Still 2
- Still 1
- Input 1 – 12
- CLN PVW (Clean PVW)
- CLN PGM (Clean PGM)
- PG + DSK
- PVW
- PGM
- MultiV (Multi view)

Multiviewer

AutoNum: The Multiview windows can be automatically numbered, and this sub-option turns ON/OFF automatic numbering.

Label Inf: This sub-option turns ON/OFF Label information. Input label is followed by information which describes the input as still, live, frozen image or simply a clip.

Trns Lab: This sub-option turns ON/OFF Label Transparency. Once enabled, the background of the label is then turned from a solid color to transparent.

Mode

The HS-3200 Multi-view monitoring is available in different multi-image layouts. These outputs can be used to monitor video and audio in a number of different configurations. For each setup, embedded audio level indication is also available on all inputs as well as the Preview and Program windows.

Mode 1				Mode 2				
Preview		Program		Preview		Program		
1	2	3	4	1	2	3	4	5
5	6	7	8	3	4	5	6	7
				8	9	10	11	12

Mode 3						Mode 4		
Preview			Program			Program		1
1	2	3	4	5	6	Program		2
7	8	9	10	11	12	3	4	5

Tally Mode

Tally output port generally sends two tally signals to each channel. In Datavideo products, **Red** indicates On-Air, and **Green** indicates next video source. On the Multiview screen, the tally light is indicated by rectangular borders around the input sub windows.

The HS-3200 provides two tally modes:

Normal: If in normal mode, tally lights of all video sources enabled on PGM view will be turned ON (**Red**). These sources include PGM, PIP and Key sources. While transition is in progress, tally lights of all video sources enabled on PGM view do not change color. The tally light will only change color (**Red → Green**) after transition of PGM and PVW views is complete. However, for video sources on the Preview window, the tally lights will be enabled **Green**, and the color is changed to **Red** as soon as the transition is triggered.

Audio Mixer: If Audio Mixer mode is selected, tally lights of all video sources enabled on PGM view will also be turned ON (**Red**). While transition is in progress, tally lights of all video sources enabled on PGM view do not change color. The tally light will only change color (**Red → Green**) after transition of PGM and PVW views is complete. However, for video sources on the Preview window, the tally lights will be enabled **Green**, and the color is changed to **Red** as soon as the transition is triggered.

GPI Out

GPI is designed to allow the user to trigger playback of an external playback device such as Datavideo's NVP-20 or HRS-30 unit. **GPI OUT** allows the user to configure your GPI connection.

First enable the GPI port and then set the GPI **mode**, which is either level or pulse. The pulse width can be configured in **Width** sub-option (1-9).

Once the GPI function is enabled, you can assign it to one of **Inputs 1-12** and the **delay** can be set to a value between 0 and 99.

4.8 Audio

In the **Audio** menu, you will be able to start and shut off the embedded audio of **SDI** and **HDMI** videos.

Audio	Audio	Mode On		Src PGM Audio
	PGM Audio	Mode V Fade	Main Gain 0 dB	Main Delay 0 ms
	Analog Out	Src PGM Audio	Gain 0 dB	Delay 0 ms

Audio

External audio source can only enter the HS-3200 via the analog XLR input port found on the rear panel of the main unit. Ideally the user should use the HS-3200 with an audio mixer.

It is recommended to use AM-100 or AD-200 audio mixer designed and manufactured by Datavideo. All external audio sources can be connected to AM-100 or AD-200 before entering the HS-3200. The external audio can be embedded into SDI video out.

Mode (ON/OFF): The HS-3200 allows the user to enable the embedded audio components. By changing the **Mode** sub-option from ON to OFF will mute the embedded audio.

Audio Src: This sub-option allows the user to select the audio source.

If “**Follow**” is selected, the audio will enter Audio follow Video mode, i.e. playback of the audio of the output video. If “**PGM Audio**” is selected, the HS-3200 will play the program out audio. To play the audio of a particular input video channel, select an **input number** from the following list.

- PGM Audio
- Follow
- Input 1-12

PGM Audio

Mode (V Fade/X Fade)

While working in the Audio-F-Video mode, the audio sources will also change as the video sources are switched. We can choose how the audio changes sources, whether it be a clean cut (immediate switch) or some sort of transitioned change (cross fade or fade out & in). To do this we would need to set up with the following menu options.

- **X Fade:** PGM Audio / PVW Audio cross fade
- **V Fade:** Fade out PGM Audio then fade in PVW Audio

Main Gain (-60 – 24 dB): adjustment of the input audio volume for a particular selected video input.

Main Delay (0 – 375 ms): sets the delay of the audio component of a particular selected video input.

Analog Out

You are also allowed to select a source of audio of your preference and output the selected audio via Audio OUT. Open the OSD menu and select Audio → Analog Out → Src where you may select a source of audio from the following list.

- PGM Audio
- Follow
- Input 1 – 12

If “**Follow**” is selected, the audio will enter Audio follow Video mode, i.e. playback of the PGM audio via Audio OUT **without audio output delay**. If “**PGM Audio**” is selected, the HS-3200 will only play the PGM audio via Audio OUT **with audio output delay**. You may also select to output one audio component of the 12 inputs via Audio OUT **without audio output delay**.

Gain (-60 – 24 dB): adjustment of the audio volume for a particular selected video input at the AUDIO OUT.

Delay (0 – 375 ms): sets the delay of the audio component of a particular selected video input at the AUDIO OUT.

4.9 Files

In Files, you will be allowed to manipulate different files such as clips, still pictures and user memories.

Still allows the user to load images from the memory, save images to the memory, and save the images captured. **User** allows you to **load** previously saved settings and **save** the currently configured settings. In **Clip**, you will be able to browse through the clip files and load the clips directly on the switcher. All three file types will be discussed in the following sub-sections.

User Mems

In this option, the user is allowed to **load** previously saved settings and **save** the currently configured settings.

Advanced mode options

Files	User			
	Load Mem	Memory	1	Load
	Save Mem	Memory	1	Save

Load Memory

Use the up/down arrow to scroll to the desired memory location and load the saved setting by selecting “**Load**”.

Note: The user can also press one of the USER memory shortcut buttons (1-3) on the control panel as a quick way of loading those previously saved User configurations.

Save Memory

Use the up/down arrow to scroll to the desired memory location and save the current setting by selecting “**Save.**”

Still

STILL image is an image pre-loaded to the HS-3200's input buffers (Input 1-12). In the **Still** menu, the user is allowed to load still pictures from the machine's internal memory to the input buffer, save still pictures to the machine's internal memory, view thumbnail pictures and grab program image to the specified still memory locations.

Files	File Type	Still		
	Load Still	Load	Still Num 1	Still 1
		Thumbnail Picture – 1	Thumbnail Picture	Thumbnail Picture + 1
	Save Still	Save	Still 1	Still Num 1
				Delete
	Grab Still	Grab	Still 1	

Load Still

Upon selecting "**Load Still**", the user can then choose the memory location from which the still image is loaded. The system memory can store up to 500 still images. The following are the destinations to which the still image can be loaded:

- Still 1: Still 1 button
- Still 2: Still 2 button
- Input 12: Input button 12
- Input 11: Input button 11
- Input 10: Input button 10
- Input 9: Input button 9
- Input 8: Input button 8
- Input 7: Input button 7
- Input 6: Input button 6
- Input 5: Input button 5
- Input 4: Input button 4
- Input 3: Input button 3
- Input 2: Input button 2
- Input 1: Input button 1

Select "**Load**" to load the still image to the determined destination.

Image Preview is available below the "**Load Still**" row. "**Thumbnail Picture – 1**" allows the user to preview the previous image, "**Thumbnail Picture**" displays the image that will be loaded when "**Load**" is selected, and "**Thumbnail Picture + 1**" shows the next image.

Note: The user is allowed to import still picture files. It is recommended to use 24-bit without Alpha bmp, png and jpg formats.

Save Still

"**Save Still**" allows the user to save the still image to a specific memory location. The user should determine the source of the still image first. The available sources are listed below:

- Still 1: Still 1 button
- Still 2: Still 2 button
- Input 12: Input button 12
- Input 11: Input button 11
- Input 10: Input button 10
- Input 9: Input button 9
- Input 8: Input button 8
- Input 7: Input button 7
- Input 6: Input button 6
- Input 5: Input button 5
- Input 4: Input button 4
- Input 3: Input button 3
- Input 2: Input button 2
- Input 1: Input button 1

To complete the save, the user can simply select **“Save”** after determining the memory location.

Grab Still

“Grab Still” function grabs an instant of the video image on the Program view to the destinations listed as follows.

- Still 1: Still 1 button
- Still 2: Still 2 button
- Input 12: Input button 12
- Input 11: Input button 11
- Input 10: Input button 10
- Input 9: Input button 9
- Input 8: Input button 8
- Input 7: Input button 7
- Input 6: Input button 6
- Input 5: Input button 5
- Input 4: Input button 4
- Input 3: Input button 3
- Input 2: Input button 2
- Input 1: Input button 1

After determining the destination to which an instant of the video image is captured, simply select **“Grab”** to trigger the image grab.

In the following sections, we will show you how to import still images from the PC to the switcher and load the imported file to the switcher. You are also allowed to export still images from the switcher to the PC for file editing.

Loading still images

The HS-3200 allows the user to load still images saved on the machine to the Multiview screen. Please follow the steps outlined below to load the still picture.

1. Press the **MENU** button to open the OSD menu on the Multiview display.
2. Open the **Stills** menu option as shown below.

Files	File Type	Still		
	Load Still	Load	Still Num 1	Still 1
		Thumbnail Picture – 1	Thumbnail Picture	Thumbnail Picture + 1
	Save Still	Save	Still 1	Still Num 1
				Delete
	Grab Still	Grab	Still 1	

3. In the **Load Still** sub-option, first select the still picture that you would like to load (**Still Num**). The still picture preview is shown in the row right below the **Load Still** row.
4. In the field next to **Still Num**, select a destination to which the still picture will be loaded. Once the destination is determined, select **Load** to load the still picture to one of the following destinations:
 - Still 1: Still 1 button
 - Still 2: Still 2 button
 - Input 12: Input button 12
 - Input 11: Input button 11
 - Input 10: Input button 10
 - Input 9: Input button 9
 - Input 8: Input button 8
 - Input 7: Input button 7
 - Input 6: Input button 6
 - Input 5: Input button 5
 - Input 4: Input button 4
 - Input 3: Input button 3
 - Input 2: Input button 2
 - Input 1: Input button 1

Clip

The **CLIP** or Stinger Transition Effect is basically an animated effect added during transition of two video sources. The animated effect is generated by a clip file which consists of a series of sequential files in **bmp/jpg/png/pic** formats. In the next few sections, you will be shown how you can load the existing clip on the switcher, and import the clip to the switcher from the PC.

Advanced/Basic mode

Files	File Type	Clip		
	Load Clip	Load	Clip 0	Clip Settings
		Thumbnail Clip - 1	Thumbnail Clip	Thumbnail Clip + 1
		Clear Clip		Delete Clip

Load Clip

In this sub-option, use the Up/Down arrows on the physical keyboard of the switcher to browse the clip files. Once “Load” is pressed, the selected clip will be loaded into the clip buffer and replace the previously loaded clip. **As the clip is being loaded, you will be able to view its progress on the Preview window.**

Note: The HS-3200 comes with pre-loaded clip files. The HS-3200 also allows the user to import customized clip files. It is recommended to use 32-bit with Alpha png format.

You can preview three clip videos at the same time. “Thumbnail Clip – 1” allows the user to preview the previous clip, “Thumbnail Clip” displays the clip that will be loaded when “Load” is selected, and “Thumbnail Clip + 1” shows the next clip. **To enable the Clip (Stinger) transition mode, simply press the CLIP button.**

To clear the loaded clip from the buffer, simply select “Clear Clip.” To remove clip from a memory location, select “Delete Clip.”

Clip Settings

Clip Settings allow the user to set the Clip’s Start/End & Mid (Transition points) frames. After users have imported a clip, they often find that it needs some small adjustments so with these settings the user can skip unwanted frames at the start and end of the Clip. They can also choose the frame at which the fade from PGM to PVW occurs. The default is to do the fade in the middle of the clip but depending on the actual clip, the user may want to alter this position.

- **Start Frm:** Adjusts the start frame number of the Clip
- **End Frm:** Adjusts the end frame number of the Clip
- **Mid Frm:** Adjusts the PGM to PVW fade point of the Clip
- **Cancel:** Cancels any changes
- **Save:** Saves the changes for this clip as each clip is allowed to have different settings.

Note: Clip Settings will be enabled only after the clip is loaded.

Loading the existing Clip for Stinger Transition Effect

The HS-3200 allows you to generate the stinger transition effect. To do this, the user should load the clip saved on the machine first. Follow the steps outlined below to load the clip.

1. Press the **MENU** button to open the OSD menu on the Multiview display.
2. Open the **Clip** menu option as shown below.

Files	File Type	Clip		
	Load Clip	Load	Clip 0	Clip Settings
		Thumbnail Clip - 1	Thumbnail Clip	Thumbnail Clip + 1
		Clear Clip		Delete Clip

- In the **Load Clip** option, first select the clip that you would like to load. The **Clip Preview** is shown in the row right below the Load Clip row.
- Select **Load** to load the clip. The load progress prompt “**Loading Clip XX/XX ...**” will appear on the Preview window. Once loaded to the clip buffer, the previously loaded clip will be replaced.

Note: The load process can take up to tens of seconds.

- To enable the Clip or Stinger transition mode, simply press the **CLIP** button.

4.10 Setup

In the “Setup” menu, the user can change the **resolution**, switch between full and simplified menu versions, reset the HS-3200 to its **Factory Default** values, adjust the **menu preferences**, enable/disable **Auto Save**, choose the preferred OSD menu **language**, **upgrade firmware** and view the **current firmware versions** (Interface, Mainboard and Keyboard).

Advanced mode options

Setup	Standard	1080p/59.94	Save Setup	
	Menu Mode	Advanced		
	Menu Pref	Blue	Transp 1	
	Menu Pos	Bot		
	Keyboard	Brightness 3		
	Auto Save	Off		
	Factory Def	Restore	Restr Names	
	Language	English		
		Network	Network Def	
	HS-3200	s/w: v1.1.1.1	f/w: 2015-08-03	Kbd: v2.15

Addr Mode	DHCP			
IP Addr	192	168	100	101
Network Mask	255	255	255	0
		Cancel	Save	

Standard

This option allows the user to choose the appropriate output resolution such as 1080i/50. Once done, simply select “**Save**” to confirm the selected output resolution. The available resolutions are 1080p/60/59.94/50, 1080i/60/59.94/50, and 720p/60/59.94/50.

Menu Mode

The user is allowed to switch between full and simplified menu versions. Select “**Advanced**” for full menu display or “**Basic**” to display a condensed version of the OSD menu.

Menu Preference

In menu preference, the user is allowed to set the menu color, menu transparency level, menu size and the display position.

Menu color: the available options are blue and grey

Options of **Menu Transparency** are listed below:

0: No Transparency

1: Background 50% Transparent (buttons not Transparent)

2: All Menu 50% Transparent

Menu Position

Menu Position gives the user ability to select several positions for the Menu area on the Screen. The current options are Centre, Top, Left, Right and Bottom.

Level

There are two different audio standards available for selection. The user can either select the EBU or SMPTE standard. By selecting AUTO allows the device to automatically detect the audio standard.

Note: When the image is 50 Hz, the audio follows EBU standard and when the image is 59.94/60 Hz, the audio follows SMPTE standard.

Keyboard

Brightness: This option allows you to adjust the keyboard brightness with 5 being the brightest and 1 being the dimmest.

Auto Save

When enabled, your last settings will be automatically saved within 5-10 seconds after shutting down the OSD menu. Do not shut down your machine during this time. At the next boot, the machine will automatically load the last saved settings. Note that **Still Load** also triggers auto save.

Note: The **Auto Save** function does not instantly save new settings; it is only triggered 5 to 10 seconds after the OSD menu is closed. This is to avoid adverse effects on the smoothness of operation.

The **Auto Save** function does not apply to the resolution setting. To change the SE-3200's resolution, go to “**OSD Menu/Setup/Standard**” and then select “**Save Setup**” to save the new setting.

Factory Default

Restore: This option resets the machine to the factory default settings.

Reset Names: This resets the Multiviewer labels (Input 1-12) to their default settings.

Language

The available languages for OSD menu are English, Traditional Chinese and Simplified Chinese.

Network

Addr Mode: The available network connection modes are **DHCP** and **Static**. The default connection mode is **Static** with an IP address of **192.168.100.101**.

IP Addr: Manually enter the IP address if **Static** is chosen.

Network Mask: Manually enter the network mask if **Static** is chosen.

Cancel: Select to cancel all changes made.

Save: Select to save all changes made.

Software

This option is only available when the USB storage device containing the latest firmware file is inserted. Select Upgrade to start the firmware upgrade process. Refer to the [FIRMWARE UPGRADE](#) section for more details.

At the bottom of the menu, you will be able to view the version number of the latest firmware installed.

Chapter 5 Basic Operation

The switcher's control panel is the main control interface for the user to select video sources and take them to air during live production. On the control panel, the user will be allowed to select the transition style, enable/disable various keyers, and add logos to the program view.

The OSD menu allows the user to adjust transition settings, configure chroma keyers and PIP windows, assign inputs and outputs and modify audio parameters.

This section describes how you can switch video sources on the control panel using simple operations.

5.1 Video Switching

First let's learn the basics of video switching.

Program and Preset rows

This row of buttons is typically used to select the switcher's main Program output image. The currently selected source being sent to the Program outputs will be **backlit Red** on this row. Simple cuts between sources can be performed on this row by pressing on the source number required for the next shot.

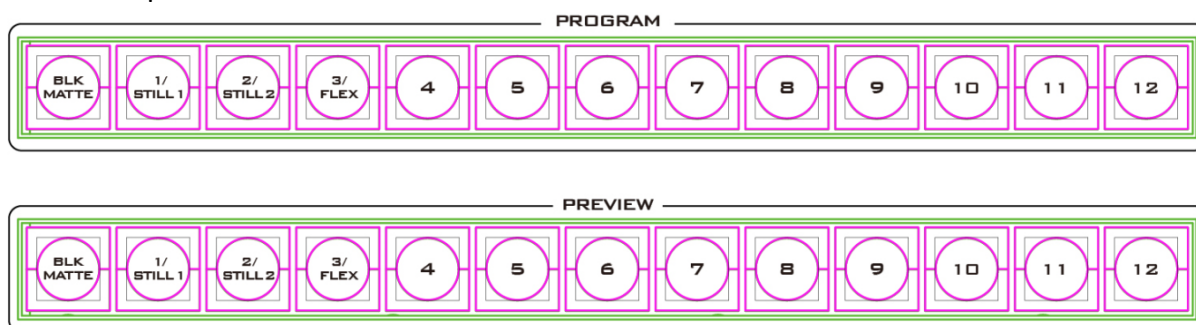

This row of buttons is typically used to select the switcher's Preview or Next source output image. The currently selected source will be **backlit Green** on this row. You can transition between sources using the **T-Bar**, the **CUT** button or the **AUTO** button.

Note: *The keys on the Program and Preview rows will still be active while the T-Bar is active or moving.*

Black and MATTE View



The **BLK/MATTE** button allows the user to switch between a black background, a matte colour and color bars on Program and Preview screens.

The **MATTE** color can be configured in the OSD menu. Simply go to **'Start'** → **'Matte'** and then adjust **Luma**, **Saturation** and **Hue**.

For **Hue** value, **Red** is 0, **Green** is approximately 120 and **Blue** is approximately 240. For secondary colors, **Yellow** is approximately 60, **Cyan** is approximately 180 and **Violet** is approximately 300.

The **Sat** or **Saturation value** refers to the intensity of the color selected in **Hue**. As the saturation increases, the color appears to be more pure. As the saturation decreases, the color appears to be more washed-out or pale.

The **Luma value** relates to how bright or dark the selected color or hue is. The higher the **Luma** value, the brighter the color selected in **Hue**.

Flex Output

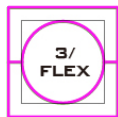

The **Flex™** output allows the user to show a variety of sources at the same time these can then be fed as one combined image to the HS-3200 Program or Preview output.

The **Flex™** output is basically a combination of one background image and four other Picture in Picture windows. Press and hold the **SHIFT** button and then press the **FLEX** button to activate the **Flex™** output. To deactivate, press the **FLEX** button again.

You will have the ability to place a user defined color border around the smaller PIP windows. You can re-size, crop, rotate and position the PIP windows in almost any manner that you wish. See **Section 4.5 Flex Src** for details on the Flex Output Configurations.

Still button

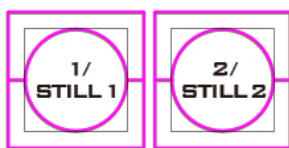

Press and hold the **SHIFT** button and then press the **STILL** button to switch the Main Program view to a still picture. Before pressing the Still button, make sure the still pictures are loaded to the still buffers (Still 1/2), which can be done in the **OSD** menu.

5.2 Transitions

The **Transitions** group of buttons allows the user to decide how to bring the selected Preset / Next source image to the Program output. The HS-3200 user can decide to use a **CUT, MIX, WIPE** or **DVE (Digital Video Effect)** transition. In order to use these transition options the **TRANS BG** (Transition Background) Button needs to be enabled (backlit Red) in the **TRANS EFFECT** area of the HS-3200 Control Panel.



AUTO Button



The **AUTO** button is used instead of the manually operated **T-Bar** and automatically performs the complete selected transition between Program and Preset over a set period. The **M/E** value in the **START** menu is used here. See [Section 4.1](#) on page 37 also.

CUT Button



The **CUT** button is used to immediately switch between the currently selected Program and Preset sources.

MIX Button



The **MIX** button is selected when a dissolve or fade transition between the selected Program and Preset sources is required. This **MIX** transition is produced by then moving the **T-Bar** manually or by pressing the **AUTO TRANS** button.

**Program View
Before Transition**



**Transition in Progress
(MIX Effect)**



**Program View
After Transition**



WIPE/DVE Button



The **WIPE/DVE** button is selected when a 2D wipe or a 3D DVE transition between the selected Program and Preset sources is required. This WIPE or DVE transition effect is produced by then moving the **T-Bar** manually or by pressing the **AUTO TRANS** button.

**Program View
Before Transition**



**Transition in Progress
(WIPE Effect)**



**Program View
After Transition**



Clip Button



Press the **Clip** button to enable the Clip (Stinger) transition mode.

The Stinger Transition Effect is basically an animated effect added during transition of two video sources. The animated effect is generated by a clip file which consists of a series of sequential files in **bmp/jpg/png/pic** formats. The Stinger transition is produced by then moving the **T-Bar** manually or by pressing the **AUTO TRANS** button.

FTB Button

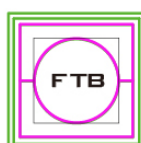

The **FTB** button (Fade To Black) fades the current video program source to black. When pressed again it acts in reverse from complete black to the currently selected program video source.

T-Bar

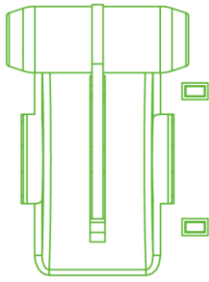

This performs a manually controlled transition from the current program source to the selected preset source. The selected transition wipe, dissolve or animation will be used. When the **T-Bar** has travelled as far as it can go, the transition between sources is complete. Please note that the **T-Bar** can be operated bi-directionally.

The **T-Bar** has indicators next to it, which light when the transition is in progress indicating the direction of operation and is off after the transition is complete.

WIPE Selection MENU

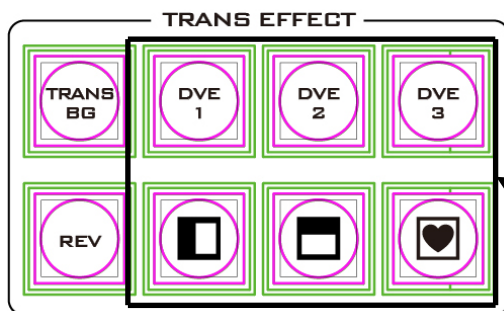

There are 32 different 2D WIPE effects and 3 different 3D WIPE effects to choose from when using the HS-3200 switcher. To select a different WIPE transition, either select a WIPE style in the **TRANS EFFECT** area of the HS-3200 Control Panel or the **Start** Item of the OSD Menu (see the table below). Before you make the selection, make sure the **TRANS BG** and **WIPE/DVE** buttons are enabled.

Start	Transition	M/E	60	DSK	15	FTB	60
	Type	WIPE					
	Wipe Effects	Wipe	1	Soft	0%	Width	1%
	Border	Luma	100%	Sat	80%	Hue	0
	Position	X	0%	Y	0%		
	Matte	Luma	100%	Sat	80%	Hue	0

Note: Open the **OSD menu** by pressing the **MENU** button in the **MENU** area of the HS-3200 Control Panel.

To select a **WIPE** on the **OSD menu**, navigate to the **WIPE** option under **WIPE EFFECTS** and then select a **WIPE number**. Each WIPE transition also has flexible user options to tailor the look of the transition. All wipes have an optional colour border applied. The wipe border **width** and **colour** are also chosen within the menu system.

Soft Value

This value allows the 'inside' and 'outside' edge softness of the Wipe Border to be controlled. A low value makes a sharp or hard wipe edge. A large value results in a softer or diffused wipe edge.

Width Value

This value determines how wide the actual wipe effect is. A low value makes a narrow wipe. A large value makes a wider wipe.

Hue, Sat and Luma values

The colour of the Wipe Border Matte can also be controlled by adjusting the **Hue, Sat** and **Luma** values.

Wipe Position

Certain Wipes, such as the **Circle** and the **Oval Wipes**, allow the Wipe position to be controlled.

The **X value** allows the selected wipe to be offset to the left or right of the screen.

The **Y value** allows the selected wipe to be offset to the top or bottom of the screen.

REV Button



When the **REV** Button is **OFF** the selected WIPE or DVE transition will operate in its default direction only. When the **REV** Button is **ON** then the selected transition will operate in the reverse direction.

5.3 Managing Still Pictures

On the HS-3200 Switcher, the user will be allowed to manipulate uncompressed still pictures with Grab and Frame Store functions. In this section, you will also be guided to load the stills saved on the switcher and display them on the monitor.

The Main Unit has one frame store to which a still can be loaded, and the unit has enough storage space for about 500 uncompressed stills.

Grabbing & Saving a Still to memory

The Grab & Save options of the OSD menu allow new Still Images to be created by grabbing & saving the **current Program video frame image** to one of the 2 internal stills buffers or the 12 internal input buffers in the HS-3200.

1. Press the **MENU** button to open the OSD menu (shown below) on the Multiview display.

Stills	File Type	Still		
	Load Still	Load	Still Num 1	Still 1
		Thumbnail Picture – 1	Thumbnail Picture	Thumbnail Picture + 1
	Save Still	Save	Still 1	Still Num 1
				Delete
	Grab Still	Grab	Still 1	

2. The Program output is grabbed to a Still buffer (Still 1 or 2) or an Input buffer (Inputs 1 – 12) by selecting the '**Grab**' option.

3. The user can look at the Multi Image Preview and decide if this Still should be saved.

- To save a Still from the currently selected Stills buffer, the user should select a Still number that has not been used yet, and select the 'Save' option.
- The save process takes about 15 seconds, after which the new thumbnail picture will be shown within the Stills display under the chosen stills number.

Loading an existing Still from memory

The Still Load Menu allows stills already stored in the HS-3200 to be loaded to a Still buffer (Still 1 or 2) or an Input buffer (Inputs 1 – 12).

Files	File Type	Still		
	Load Still	Load	Still Num 1	Still 1
		Thumbnail Picture – 1	Thumbnail Picture	Thumbnail Picture + 1
	Save Still	Save	Still 1	Still Num 1
				Delete
	Grab Still	Grab	Still 1	

The Still menu screen (shown above) shows thumbnail pictures of up to 3 saved stills at a time. If there are more than 3 stills stored in the HS-3200 then the Menu Control's left and right arrow buttons can be used to move through the saved stills. The stills are shown in numerical order, and any numbers not used will be blank.

To load a still, the user can move to a Still number and then select the 'Load' option.

The selected still will be loaded into the selected buffer as shown in the Still menu screen above. In the above example, still buffer 1 has been loaded with selected still number 10.

Deleting a saved Still from memory

To delete a saved still, select a still number that is no longer required. Select 'Delete' and you will be prompted to confirm the delete. Select 'YES' to remove the still from the switcher's memory and 'No' to cancel the delete.

Note: The deleted still, if pre-loaded to the current Still or Input buffer, will be kept until another still image is selected or grabbed to occupy this buffer.

FS – Frame Store Button (No Function)



The HS-3200 has twelve video channels and each of these channels has its own Frame Store, making a total of twelve Frame Stores. Each of these Frame Stores can hold one still image. This still image can be called into the production by using the FS button located at the top left corner of the HS-3200 Control Panel. The FS button allows the user to toggle between the still image of the Frame Store and the live video input connected to that same video channel.

How to choose live video input or Frame Store

- First press and hold down the FS button. The Preset row of input sources will light.

2. While still holding down the FS button, press the required input on the Preset row.
For example, pressing button 1 switches the video channel to the still picture mode.
3. To return to the live video mode, simply press the channel button again.

This selection will also be confirmed on the Multi-view output, with the selected channel showing the live input or frame store image.

Note: Before using the FS function, first make sure the still picture has been loaded to the input video channel. Refer to [Section 5.3](#) for instructions on loading still pictures.

Export/Import Still Images to/from the PC

The switcher's Image Import/Export software (**SwitcherImageImEx_vx.x.x.msi**) allows the user to import still pictures from the PC to the designated Still number of the switcher and vice versa. **The software installation package can be downloaded from the product page.** Features of the Import/Export software are listed as follows:

- Supported file formats are BMP, JPG, PNG, and PIC.
- Minimum resolution is 1280 x 720.
- Independent exported still pictures in BMP format.

Please follow the steps below to set up the system before installing the software.

- First connect the HS-3200 to a Windows computer using an RJ-45 Ethernet cable.
- Since the HS-3200 has a default IP address of 192.168.100.101 so the computer should be given the IP settings that match the same IP range as the switcher.
- Turn on the Windows computer and manually set the IP to 192.168.100.X within the **Windows Network and Sharing Centre**.

After the connection is successfully established, the system setup is complete. Now install the **Switcher Image Import/Export utility** on the computer. See [Section 3.2](#) for installation instructions.

How to use

1. After the utility is successfully installed, double click the icon to run the program. Since the program is executed for the first time, it will automatically scan the network and if multiple network interface cards are found, simply select the card that is on the same network as the device.

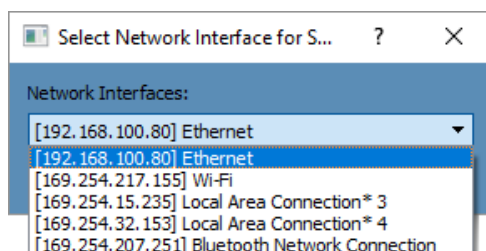

2. If the available device is scanned and found, the connection will be automatically established. After the connection is successfully established, the **Connect Status** will show **"Connected"** (will display **Not Connected** if disconnected).

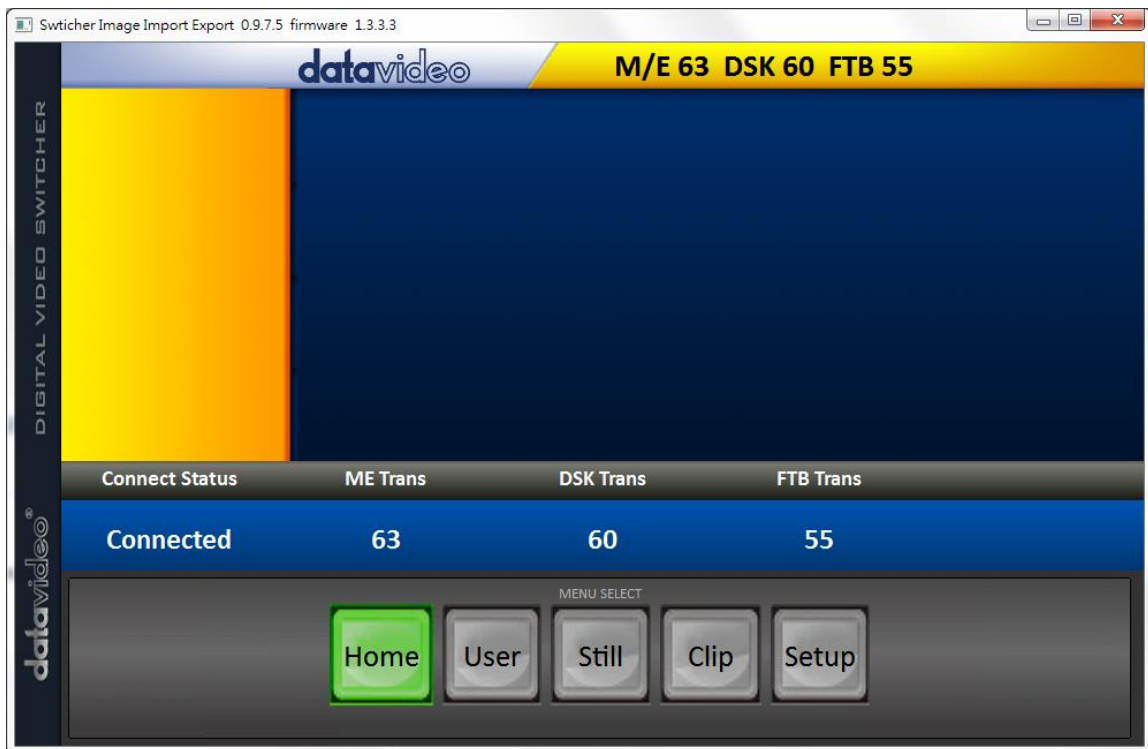

3. After clicking the **Setup** button, the network information will be displayed in the blue area.

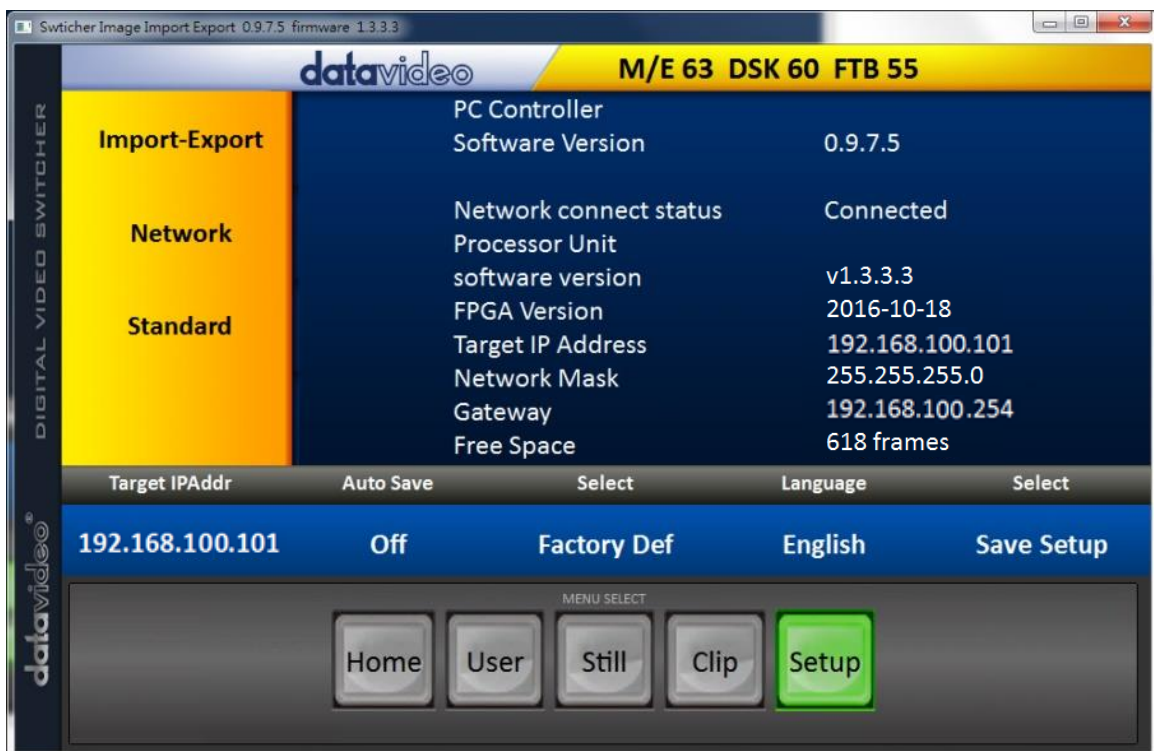

4. After clicking **Import-Export**, you will be able to see four options which are **Import Still**, **Import User**, **Import Clip** and **Export**.
5. When in Import Still, click a Still number first and enter a location for storing the still. Then click Import Still again, the interface for selecting picture files will appear. If the selected picture is not 1920x1080 or 1280x720, the following interface will be displayed to allow you to crop or enlarge the picture.

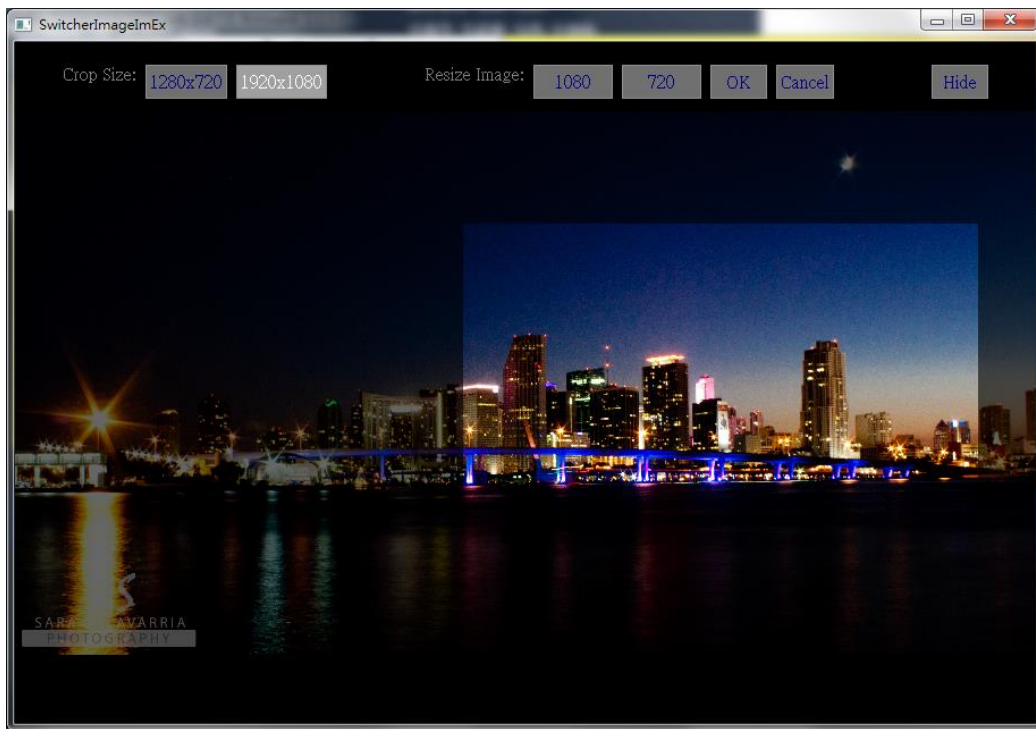

Crop Size: Select the right crop

Resize Image: You will be allowed to select two sizes, large (1080) or small (720), and zoom the picture to 1920 x 1080 or 1280 x 720.

OK: Confirm the setting and apply in the switcher.

Cancel: Cancel the selection

Hide: Hide the interface

- After the right crop is selected or the resolution is correctly configured, the new settings will be automatically applied to the picture. To confirm, click the **Still** button on the **MENU SELECT** pane to view the thumbnails.

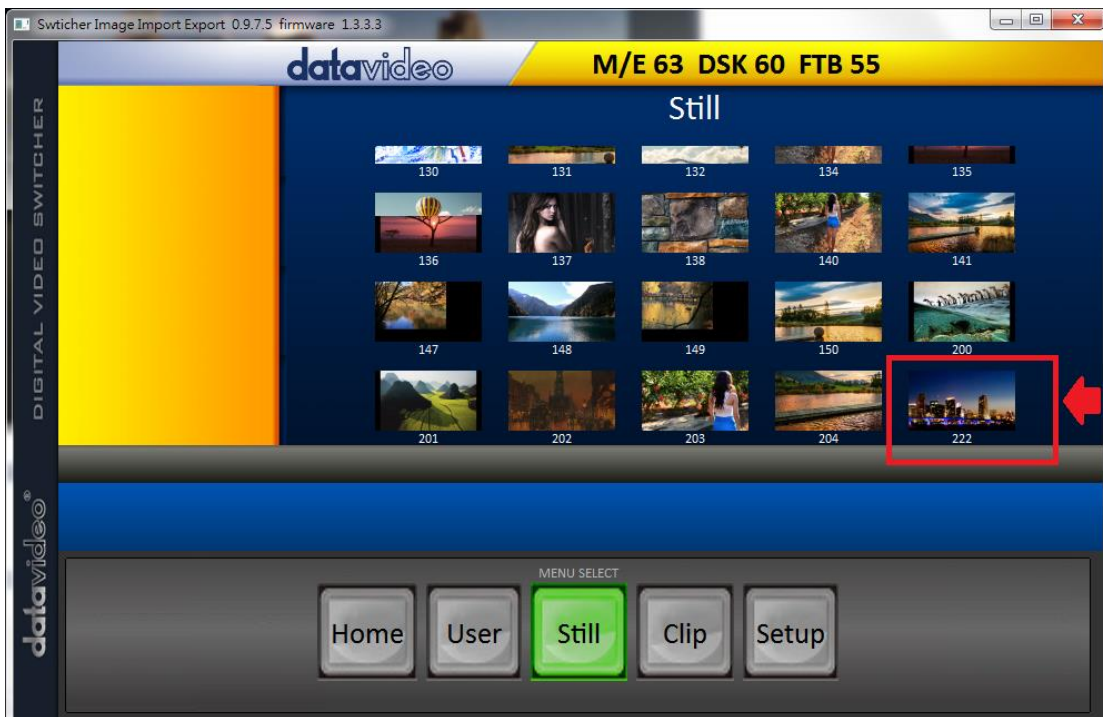

In addition to still picture import and export, the user is also allowed to import and export user memory slots to and from the PC. The **Import User** has the identical steps; select .mem file to import. The **Import Clip** allows the user to import the clip sequential files from the PC. The sequential files are numbered using the last five characters of the file name. Select one file and the system will automatically grab the file and the rest after that. The supported clip file formats are **BMP, JPG, PNG and PIC** and the optimal resolution is 1920 x 1080.

5.4 Performing a Stinger Transition

The Stinger Transition Effect is basically an animated effect added during transition of two video sources. The animated effect is generated by a clip which consists of a series of sequential files in **bmp, jpg, png or pic** format. This type of transition is very popular in sports productions for transitioning in and out of instant replays.

Files	File Type	Clip		
	Load Clip	Load	Clip 0	Clip Settings
		Thumbnail Clip - 1	Thumbnail Clip	Thumbnail Clip + 1
		Clear Clip		Delete Clip

The following sections explain how to build and perform stinger transitions.

Loading a Clip from memory

In **Clip**, use the Up/Down arrows on the physical keyboard of the switcher to browse the clip files. Once “**Load**” is pressed, the selected clip will be loaded into the clip buffer and replace the previously loaded clip.

Note: The HS-3200 comes with pre-loaded clip files. The HS-3200 also allows the user to import customized clip files. It is recommended to use 32-bit with Alpha png format.



Preview of clip videos is below the “**Load Clip**” sub-option. You can preview three clip videos at the same time. **To enable the Clip (Stinger) transition mode, simply turn ON the Clip button.**

The Stinger Transition Effect is basically an animated effect added during transition of two video sources. The animated effect is generated by a clip file which consists of a series of sequential files in **bmp/jpg/png/pic** formats. In the next few sections, you will be shown how you can load the existing clip on the switcher, and import the clip to the switcher from the PC.

How to Create the PNG Sequence for Stinger Transition Effect

Adobe After Effects is a motion graphics application that can be used for creating the clip file for stinger transition effect. After the clip file is created, there are two ways to convert the file to the PNG sequence format readable by the HS-3200 switcher in Adobe After Effects. In this section, we will show you how you can create the PNG sequence for the Stinger transition effect.

Adobe After Effects

1. Click **File** → **Export** → **Add to Render Queue** (or alternatively, you can also click **Composition** → **Add to Render Queue**).



2. The Render Queue will be displayed in the bottom pane.

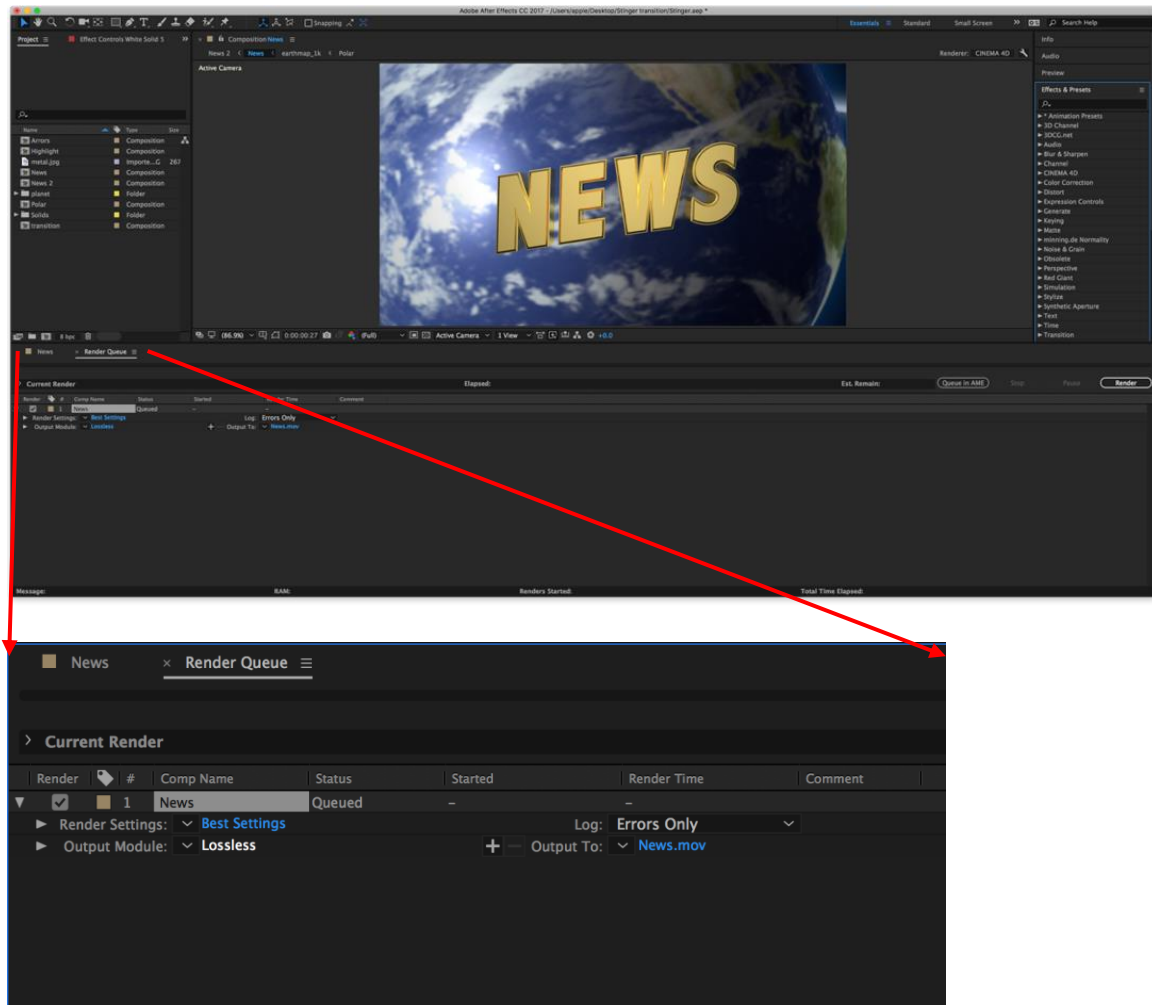

3. Click **Output Module** and on the **Main Options** window, click the **Format** dropdown list and select **PNG Sequence**.

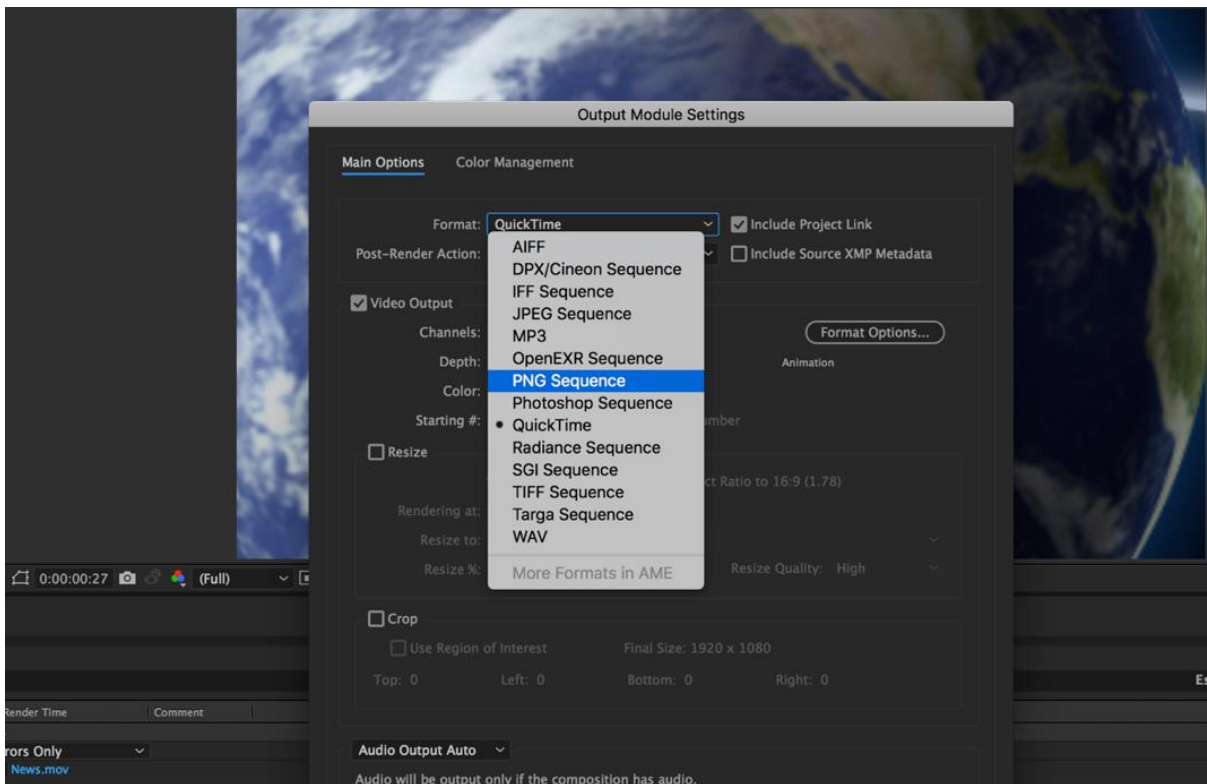

4. Click the **Channels** dropdown list and select the **“RGB + Alpha”** option.

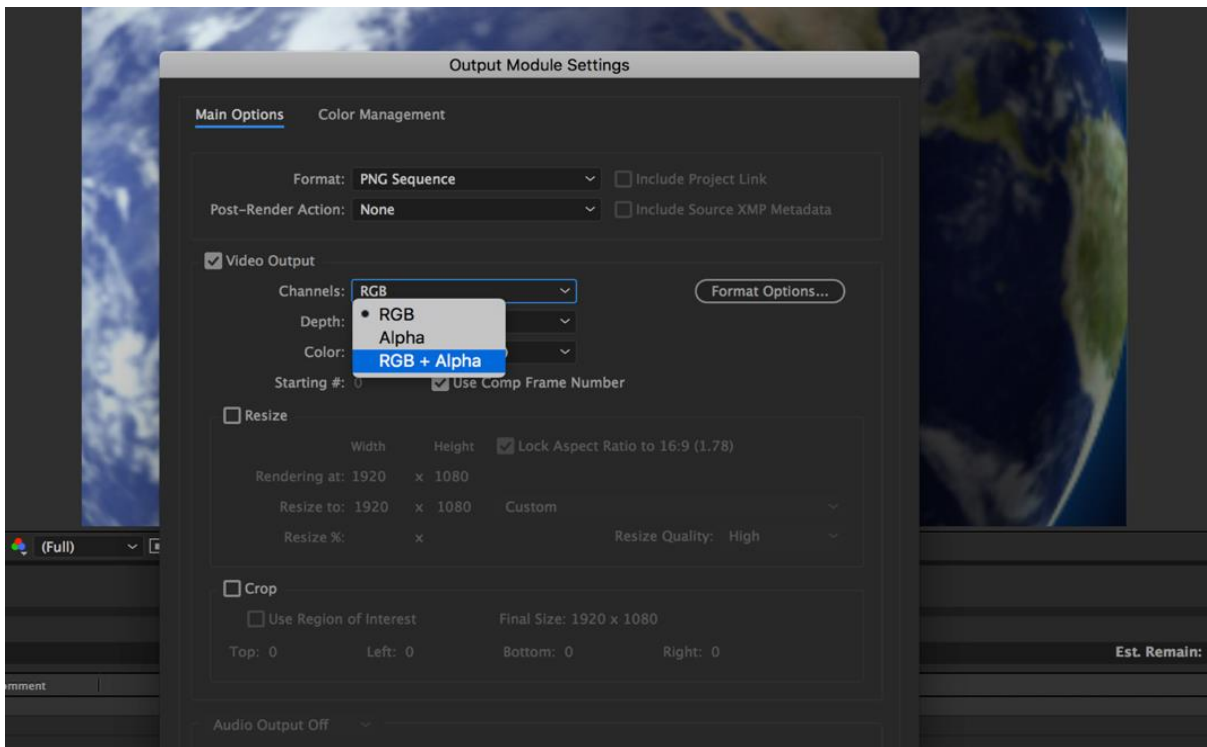

5. Click **“Output To”** and then change the location where your files are rendered. Click **Render** after that.

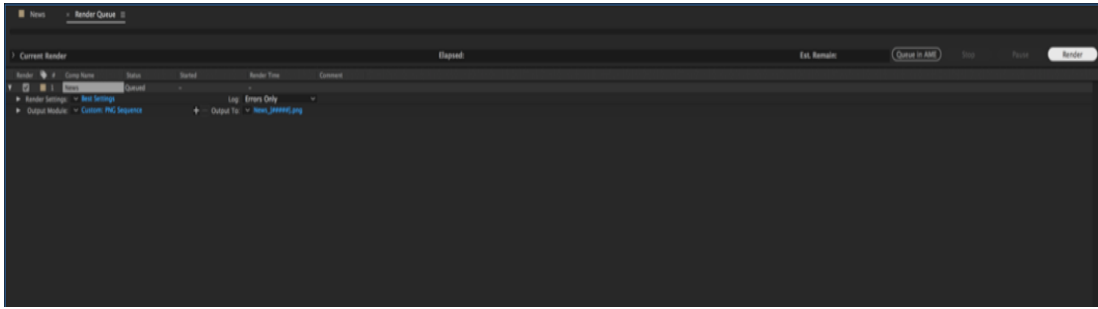

The next section outlines the file conversion procedure using the **Media Encoder CC**.

Media Encoder CC

1. Click **Composition** → **Add to Media Encoder Queue** (or alternatively, you can also click **File** → **Export** → **Add to Media Encoder Queue**).



2. Click blue fonts in **Format/Preset** fields to open the “**Export Settings**” window.

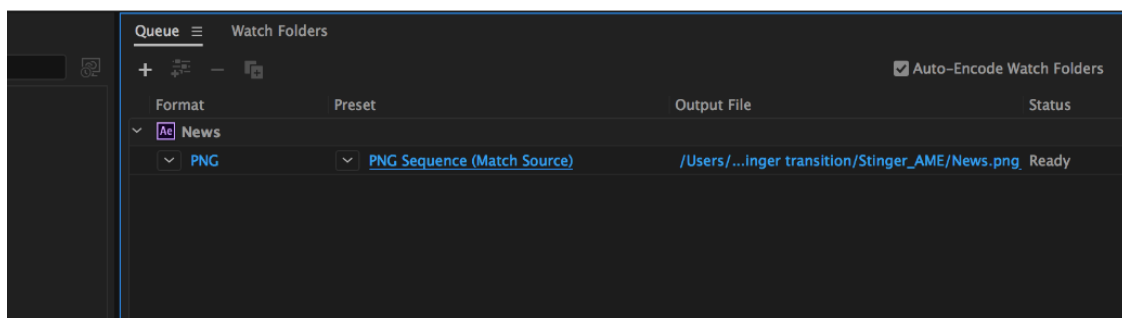

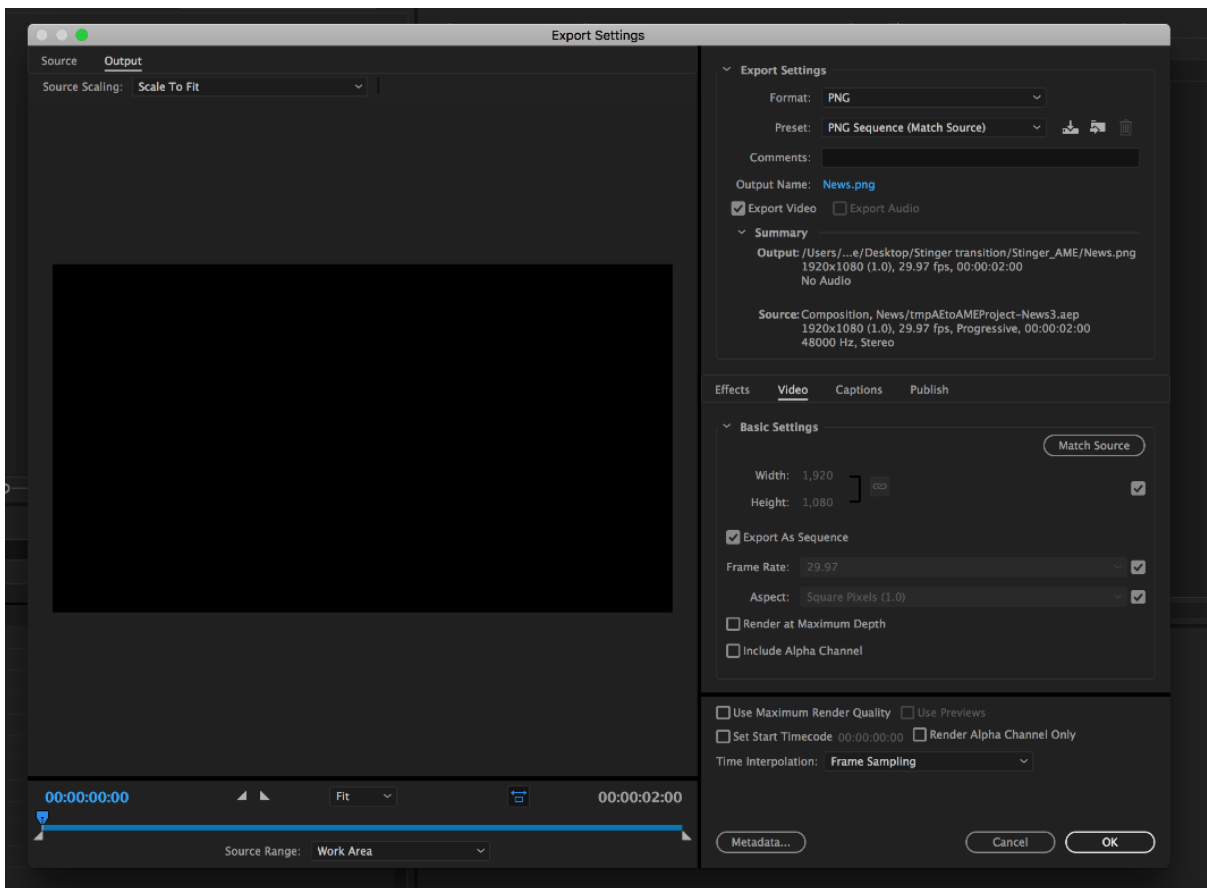

3. Click the **Format** dropdown list and then select **PNG**.

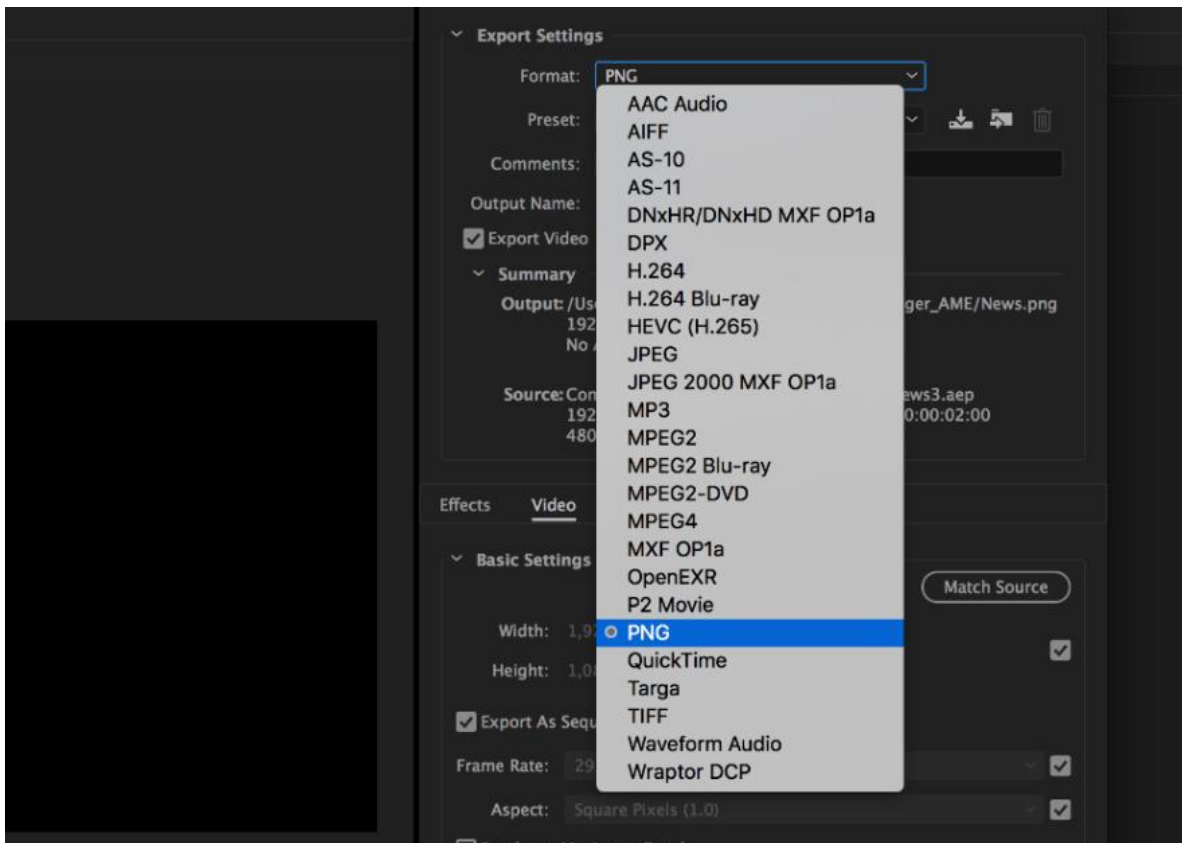

4. Click the **Preset** dropdown list and select “**PNG Sequence with Alpha.**”

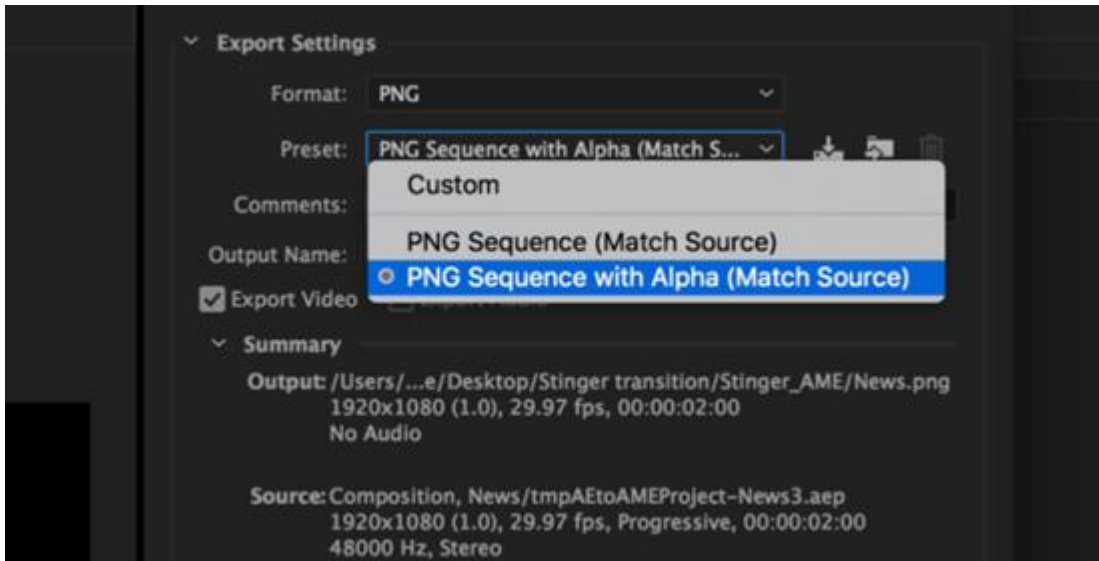

5. Make sure “**Export As Sequence**” and “**Include Alpha Channel**” are checked and then click **OK**.

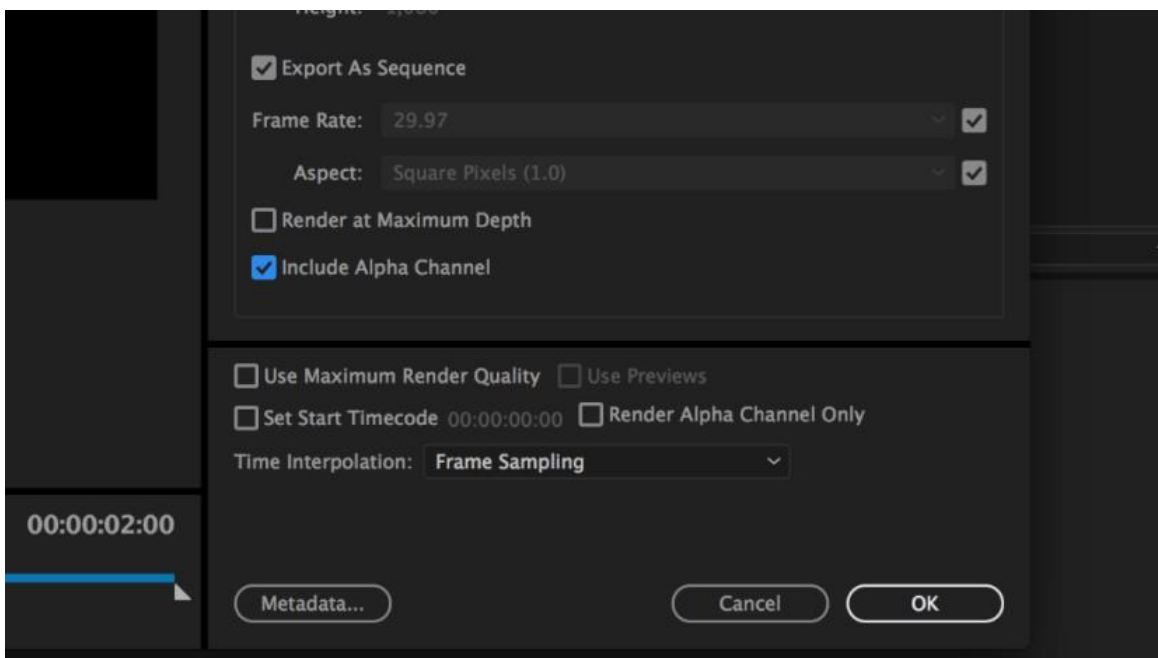

6. Select “**Output File**” to choose the render files destination. Click the green button to render.

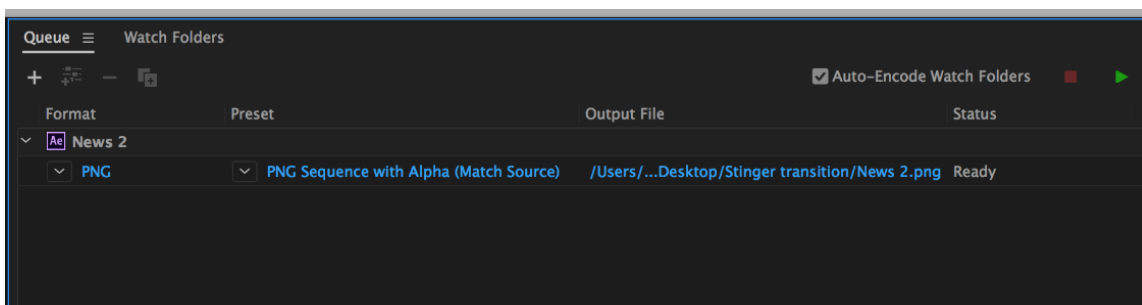

7. Once completed, the status will display “Done.”

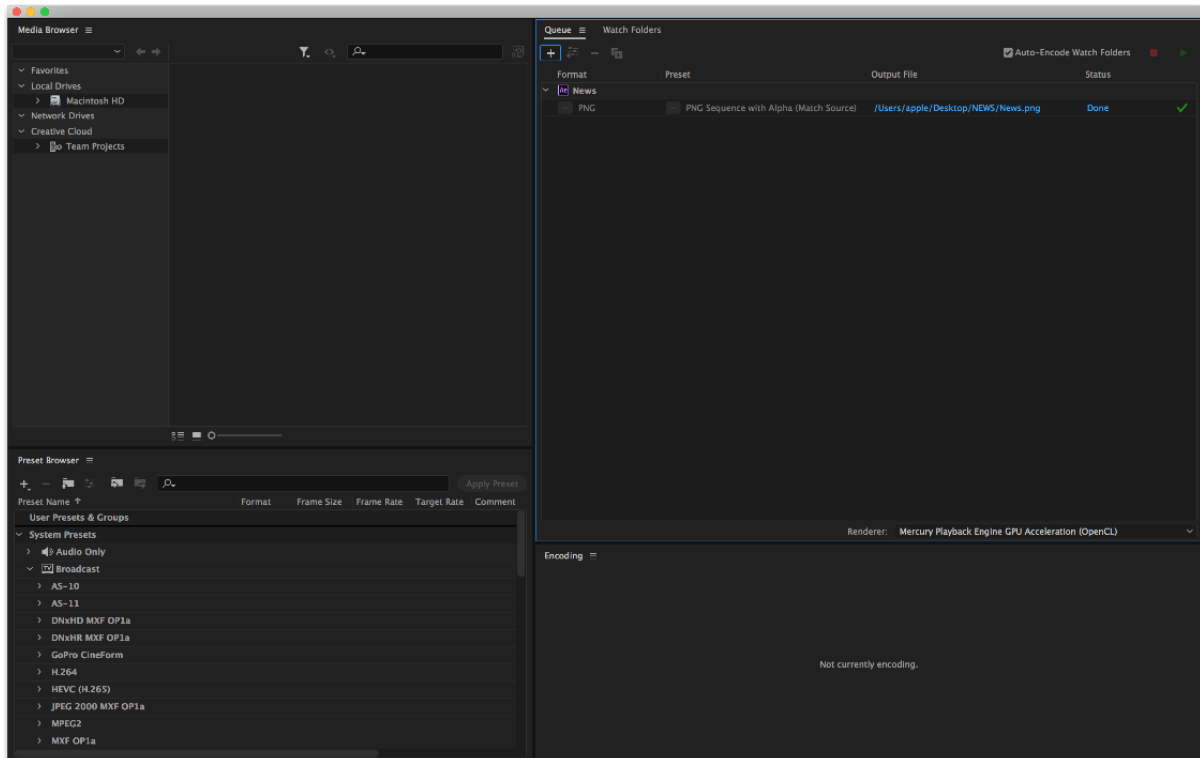

After the sequential files are created and ready, see the following sub-sections on how you can import the Clip file to the switcher.

Important things to note while creating Stinger Transition Effects

When using Datavideo’s HS-3200 Multi-Channel Switcher to design and create the Stinger Transition Effects, in addition to being creative, there are a few things that you need to take into account of.

1. Length limit of the stinger transition animation

The length of a good stinger transition animation should be approximately 0.5 to 2 seconds.

2. The HS-3200 allows a maximum of 200 image files in an animation sequence

The number of image files will determine the length of stinger transition time.

3. While designing the animation, it is best to have an image that fills up the entire frame to create a satisfactory visual effect (please see the images below).





Importing the Clip for Stinger Transition Effect from the PC

On the HS-3200, besides using the existing clips on the machine, you are also allowed to import your own clip (a series of **bmp/png/jpg/pic** files) to the HS-3200 from the PC using the **Switcher Image Import/Export utility**, which can be downloaded from the HS-3200 product page.

- First connect the HS-3200 to a Windows computer using an RJ-45 Ethernet cable.
- Since the HS-3200 has a default IP address of 192.168.100.101 so the computer should be given the IP settings that match the same IP range as the switcher.
- Turn on the Windows computer and manually set the IP to 192.168.100.X within the **Windows Network and Sharing Centre**.
- Now install the **Switcher Image Import/Export utility** on the computer.
- After the utility is installed, click and open the user interface as shown below.

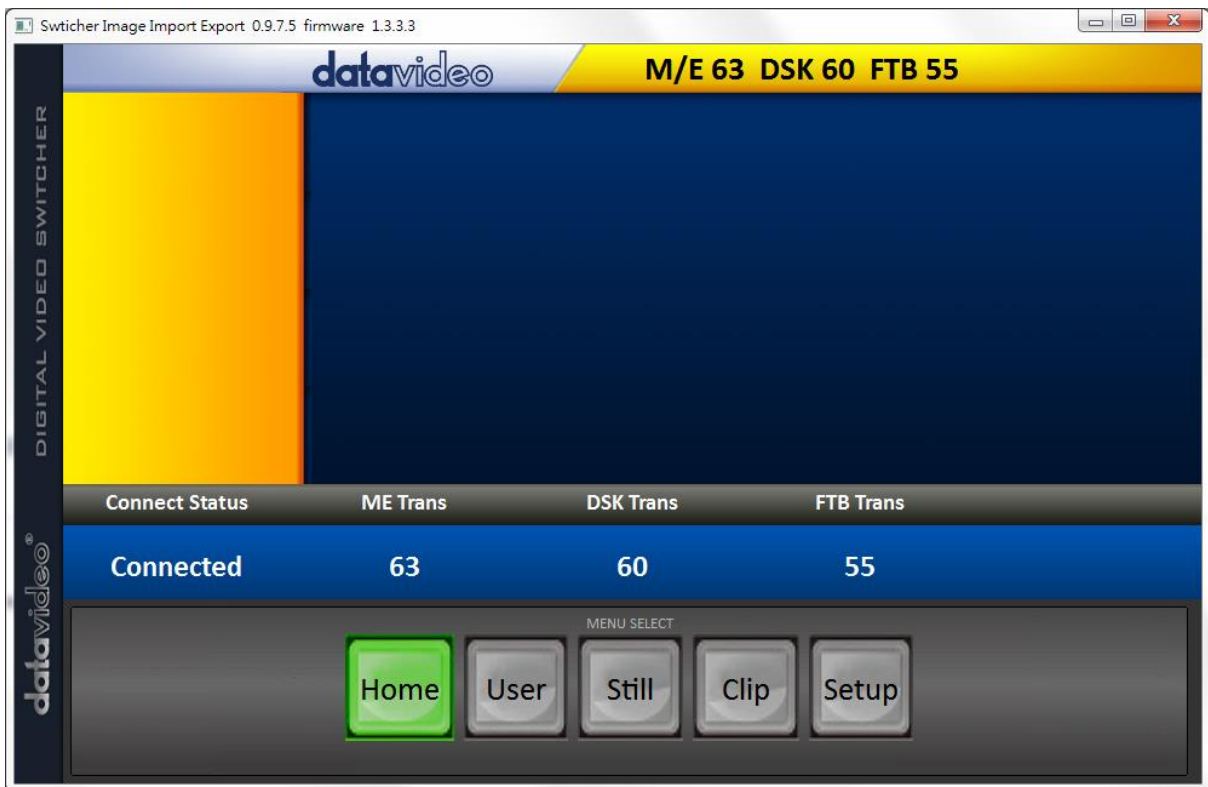

Click **Setup** on the **MENU SELECT** pane and if the connection between the HS-3200 and the PC has been successfully established, you will be able to see the network information of your switcher.

Select **Import-Export** from the yellow menu options.



The clip number allows you to select a location where you can save the clip. To import a clip from the computer into the HS-3200, select **Import Clip**.

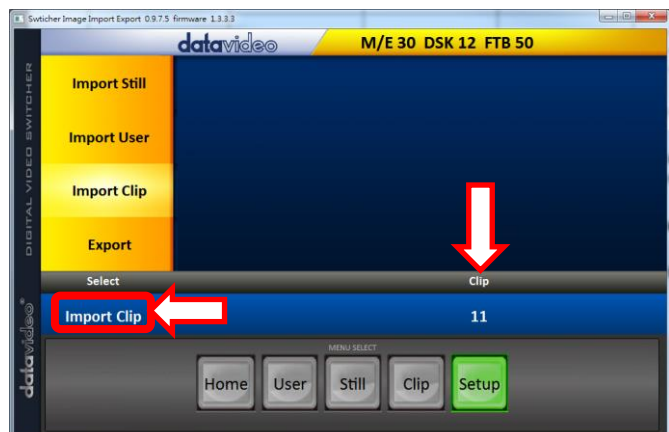

Note: The **Switcher Image Import/Export utility** does the conversion from bmp/png/jpg to the .pic file format. All you need is to give the utility a starting file location and it will give the utility an idea where to start linking all images up into a sequential animation file.

Importing Clips

Select “**Import Clip**” will open a file browser window. Browse to the directory where your clip files are saved and then select the file at the zeroth location, in our example on the right, the file name is **frame-000.png**.

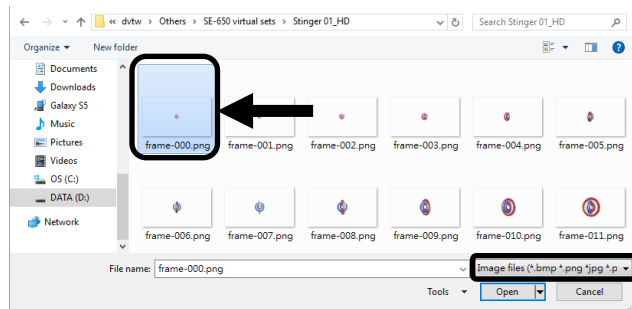

Click **Open** to start the clip import. If your files are not the .pic format, they will be automatically converted to .pic format by the **Switcher Image Import/Export utility** first.

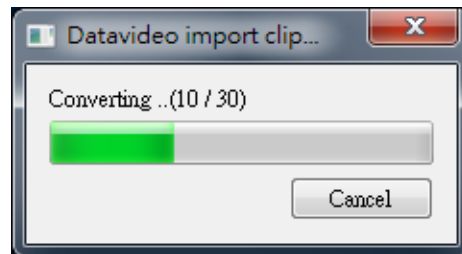

After the file conversion, the clip import will then start. After the import is complete, the progress dialog will be automatically closed.

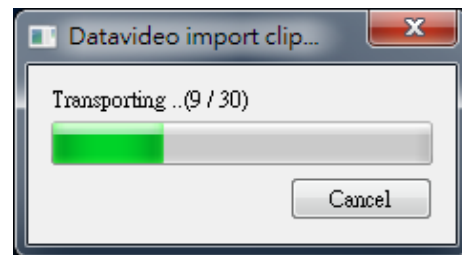

Note: Clip Conversion and Clip Import have progress dialogs that show progress & number of frames done. These dialogs also have a cancel button which allows the user to cancel the import at any stage. If the import is cancelled, then the partially imported data will be deleted.

Chapter 6 Advanced Operation

The HS-3200 is a High Definition Digital Video Switcher. As well as mixing video and audio sources, it has additional functions such as Picture In Picture (PIP), DSK, LUMA KEY, Chroma Key and Logos.

Before attempting to use the HS-3200's PIP, DSK LUMA KEY and LOGO functions it may help to first understand the order of the video layers at the HS-3200 Program (PGM) outputs.

PROGRAM or PREVIEW Layers

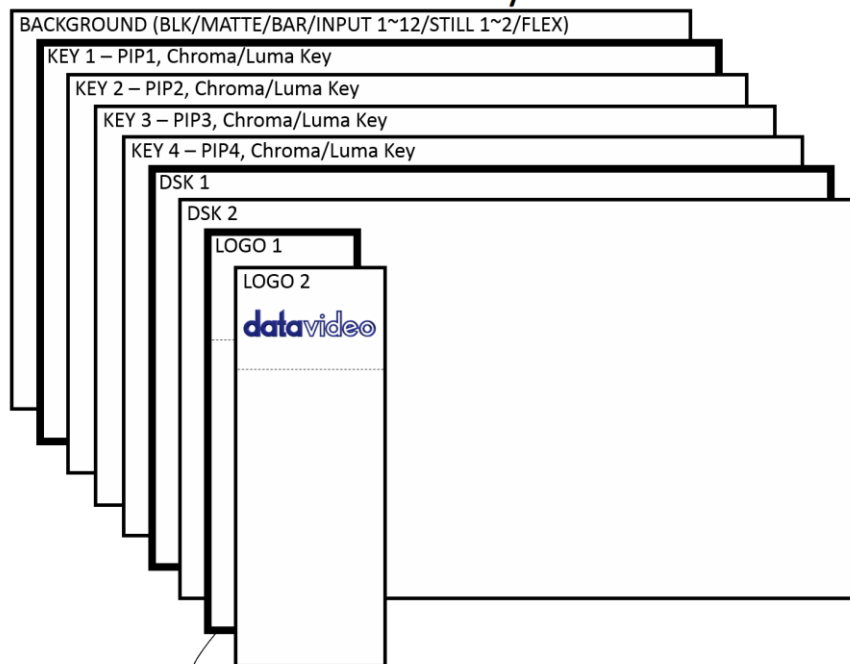

- When logos 1 and 2 are enabled on PROGRAM and PREVIEW windows at the same time, you will be allowed to select two types of logos.
- Standard logo: max size of 480 x 1080 (1 still frame)
 - Animation logo: max size of 480 x 270 (dynamic made up of 120 frames)

The **Background video layer** is the normal video layer (**black screen, color matte, color bars, inputs 1-12, still pictures 1 and 2 or Flex™ sources**) when mixing and switching with the HS-3200. It occupies the whole screen area of the Program output. This layer can be hidden or partly hidden by the PIP, DSK and LOGO layers in front of it.

The **Key 1 layer (PIP1, chroma key or luma key)** does not occupy the whole screen and is shown in front of the Background video layer when enabled.

The **Key 2 layer (PIP2, chroma key or luma key)** does not occupy the whole screen and is shown in front of the Background video and Key 1 layers when enabled.

The **Key 3 layer (PIP3, chroma key or luma key)** does not occupy the whole screen and is shown in front of the Background video, Key 1 and Key 2 layers when enabled.

The **Key 4 layer (PIP4, chroma key or luma key)** does not occupy the whole screen and is shown in front of the Background video, Key 1, Key 2 and Key 3 layers when enabled.

In some setups the Key image can be hidden behind other key images. This is not a fault. Change the position or size of the Key image if required.

The **DSK 1 layer** can occupy the whole screen. If set up incorrectly this layer can stop the video layers behind it from being seen properly. Re-adjust your DSK 1 settings or switch off the DSK1 function on the HS-3200 to restore the video behind it.

The **DSK 2 layer** can occupy the whole screen. If set up incorrectly this layer can stop the video layers behind it from being seen properly. Re-adjust your DSK 2 settings or switch off the DSK2 function on the HS-3200 to restore the video behind it.

The logo layer is the uppermost layer. If standard logo (still) is chosen, the maximum logo size will be restricted to 480 x 1080. If animation logo (dynamic) is chosen, the logo will be confined within 480 x 270.

Note: Where possible prepare and position the upper video layer elements in advance of the live production starting to avoid them appearing on the program output incorrectly.

Most broadcast networks have guidelines and advice on the use of video, images, music, logos and on screen text so it is best to check beforehand when planning a production. Do not use copyright protected content until you have the relevant permissions. Information on royalty free video, images and music is widely available, speak to your local dealer or search for advice on the internet.

6.1 Picture-in-Picture and Downstream Key

The **Picture in Picture (PIP)** feature of the **Key 1, Key 2, Key 3 and Key 4** layers can be used for displaying a smaller secondary image in front of the background video layer. This smaller PIP image can be resized, cropped, repositioned and even keyed by the user to avoid an important part of the background video layer being covered by it.

The **Down Stream Key layers (DSK 1 & DSK 2)** are placed on top of all the previous layers. These layers are typically used with Character Generator inputs for displaying titles, graphics, lower thirds, clocks and logos. Datavideo offer several Character Generator products (additional purchase) such as TC-200, CG-250, CG-350 and CG-500. If set up incorrectly these DSK layers can also stop the video layers behind them from being displayed properly.

The HS-3200 has six dedicated keyers, **Key1, Key2, Key3, Key4, DSK 1 and DSK 2**. All six keyers can be active simultaneously.

Picture-In-Picture

In this example, we are supplying the HS-3200 with an HD-SDI live video signal to input 2, this is selected on the Program row. We have also assigned a STILL image to input 6. This still image, selected on the [Keyer](#) sub menu, will be displayed in the PIP window.

Note: See [Section 5.3](#) for assigning a STILL image to input 6.

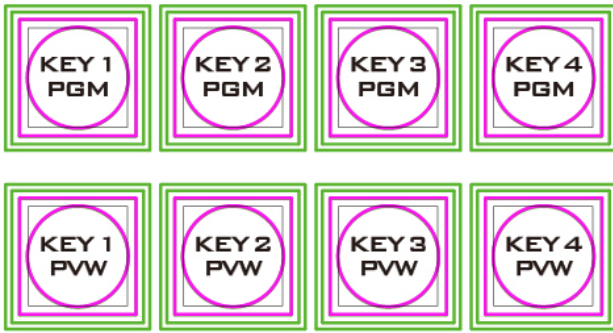

On the HS-3200 Control Panel / Keyboard there are eight **KEYER** keys. These are labelled Program and Preview. The upper **KEYER** keys relate to activating Picture-In-Picture images on the Program outputs. The lower **KEYER** keys relate to activating Picture-In-Picture images on the Multi-view or Preview outputs. Before activating

Picture-In-Picture images on the output image, you should first set these **KEYER** keys to PIP mode.

Assigning a video source input to a PIP

On the **Keyer** sub menu you can assign a selected input to the chosen PIP video layer.

1. Open the **Keyer** sub menu and in the **Keyer Ctrl** option, set **Key 1** to the desired Key (**Luma**, **Chroma** and **Linear**) and PIP mode as shown below.

Keyer	Keyer	Key 1			
	Keyer Ctrl	Luma		PIP	
		Lift 0%	Gain 1.0	Opac 100%	
	Key Source	Input 1	Fill Black	Invert Off	
	Mask	Left 0%	Right 0%		
		Top 0%	Bot 0%		

2. In the **Key Source** option, assign an input source.
3. Activate PIP window on the Preview or Program output by pressing **Key 1 PVW** or **Key 1 PGM** button so that you can adjust the PIP window while viewing the changes made.
4. Open the **P-in-P** sub menu and adjust the PIP window settings (**positions**, **border**, **shade matte** and **crop**). For descriptions of the parameters, refer to the section on [P-In-P](#) for more details.

P-in-P	Keyer	Key 1			
	Position	X 20%	Y 10%	Size 40%	
	Border	Normal			
		Luma 100%	Sat 80%	Hue 0	
		Width 2%	Soft 0%	Opac 100%	
	Shade Matte	Luma 100%	Sat 80%	Hue 60	
		Shade Soft 2%	Shade Pos 50	Direction 35	
	Crop	Left 0%	Right 0%	Size 0%	
		Top 0%	Bot 0%		

Assigning a video source to a PIP window using shortcut keys

In addition to assigning a video source to a PIP window on the OSD MENU, the user can also use shortcut keys to easily switch between different PIP image sources. Press and hold KEY 1-4 PGM buttons, and the program and preview rows will start flashing. Press the program row buttons to switch the PIP image source.

Downstream Key

In this downstream keying example, we are supplying the HS-3200 with a live video signal on input 3, this is selected on the Program or Preview row. We have also connected a TC-200 Title Creator (separate purchase) which supplies separate FILL and KEY signals of a CG image to inputs 1 and 2. These two CG inputs will be used for Linear keying the CG text or graphics over the live video from input 3.

Note: If the DSK input only has one source (FILL) for keying, select **Self**. In our example the DSK input has two sources for **Fill** and **Key Source**, so we select the **Split mode** instead.

Hardware Set Up

1. Connect the laptop to the PC IN HDMI port of the TC-200 Title Creator using an HDMI cable.
2. Locate the HS-3200's input ports at the rear of the machine.
3. Open CG-250 on the laptop and create a CG image which can then be sent to the HS-3200 via TC-200.
4. The two SDI output ports of the TC-200 are set to Fill Source and Key Source, which are respectively connected to the HS-3200's SDI 1 and SDI 2 inputs.
5. Camera is connected to the HS-3200's one of the HDMI or SDI inputs and in this example, we choose to connect the camera to SDI 3.
6. Switch ON the HS-3200's power button and after the boot up is complete, the Multiview should be displayed on the built-in monitor.

Menu Configuration

1. On the Multiview, Input 1 window displays the Fill Source, Input 2 window displays the Key Source, and Input 3 window displays the camera image.
2. Press the "MENU" button on the HS-3200's control panel to open the OSD menu on the Multiview display and then select the "Keyer" sub menu.
3. Select "DSK 1" in the Keyer option.
4. CG Overlay input setting (Input 1 / Input 2): Set the Key Source to Input 2 and Fill Source to Input 1.

Keyer	Keyer	DSK1		
	Keyer Ctrl	Linear	Split	

	Lift	0%	Gain	1.0	Opac	100%
	Key Source	Input 2	Fill	Input 1	Invert	Off
	Mask	Left	0%	Right	0%	
		Top	0%	Bot	0%	

DSK Preview and DSK Program



On the HS-3200 Control Panel / Keyboard there are four DSK keys. These are labelled Program and Preview. The upper DSK1 and DSK2 keys relate to activating Down Stream Keying on the Program outputs. The lower DSK1 and DSK2 keys relate to activating Down Stream Keying on the Multi-view or Preview outputs.



To display the CG subtitle configured previously, simply press the DSK 1 PGM or DSK 1 PVW button to enable the downstream key on the PGM or PVW screen.

6.2 Placing text on the video using luma key



The HS-3200 allows the user to place a logo or text image (ideally black and white) on the video using the luma key function. First of all, create a 1920x1080 (16:9) text image against a black or white background on a laptop. Once the text image is created, please follow the steps outlined as follows to insert the text image.

Note: If the text image is dark, choose a white background; if the text image consists primarily of bright colors, choose a black background.

1. Connect the laptop to the switcher's **HDMI Input Port 9**.
2. Press the **MENU** button to open the OSD Menu on the Multiview display.
3. Select **Keyer** to open the **Keyer** sub menu.

Keyer	Keyer	Key 1			
	Keyer Ctrl	Luma	Self		
		Lift	0%	Gain	1.0
	Key Source	Input 9	Fill	Black	Invert
					Off
	Mask	Left	0%	Right	0%
		Top	0%	Bot	0%

4. Select Key 1.

5. In the **Keyer Ctrl** option, select **“Luma”** and **“Self”** to apply luma keying effect to the connected input. The luma key removes the background, in this case, the black component of the image.
 6. In this example, the text image is against a black background so **reduce the Lift value to remove the black background**. Descriptions of the corresponding parameters are described below:
 - **Lift** (0 – 100%) adjusts the dark/black areas of the key image. **Reducing the value of Lift** will make dark areas of the key image more transparent. The background image will be showing only through the transparent areas.
 - **Gain** (0.0 – 16.0) adjusts the light/white areas of the key image. **Increasing the value of Gain** will make light areas of the key image more solid. The background image will be showing only through the transparent areas.
 - **Opac** (0 – 100%) adjusts the transparency of the overall foreground image, which is the text in this example. **Increasing the value of Opacity** will make the overall key image less transparent.
 - **Invert** (On/Off) sets the luma key color; luma key color is **white** if turned ON and **black** if turned OFF.
 7. Set the **“Lift”** to 100% if the background is in total black.
 8. **Opaque** logo can be created by setting the **“Opac”** parameter to 100%. Set **“Opac”** to 100% if an opaque logo is desired. **Semi-transparency** effect can be generated by setting the **“Opac”** parameter to a value between 0 and 100%.
 9. Under the **Source** option, select an input source to which the luma key settings will be applied. In this example, select **“Input 9”** since this is the port to which the laptop is connected.
- Note: Since “Self” is chosen, Fill input will be ignored.**
10. Exit the menu after the luma key settings are properly configured.
 11. Press the **Key 1 PGM** or **Key 1 PVW** button to place the text image on the Program screen or the Preview screen respectively.

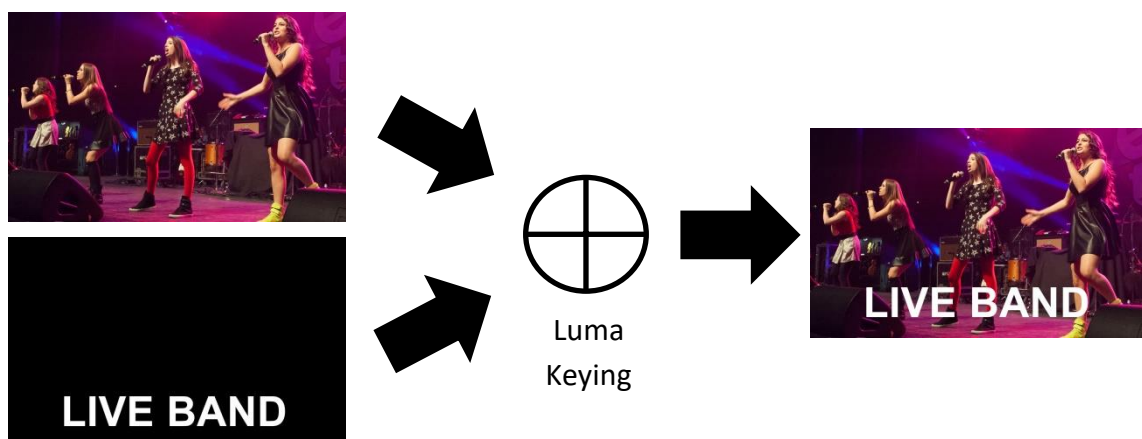

6.3 Insertion of People onto Backgrounds (Chroma Key)

The Chroma Key feature of the HS-3200 is easy to use. Typical Blue and Green screen studios can be quickly incorporated into an HS-3200 production.

The following is a quick overview of Chroma Key basics.



The **camera**, **backdrop** and **lighting** all play an important role in producing the optimal Chroma Key result. Although the HS-3200 is equipped with excellent keying controls, it is best to start with a good keyable image.

A good foreground image helps produce a good key

Three chip/Three sensor camera

We strongly recommend the use of a three chip or three sensor camera for Chroma Key shooting. If the camera has three chips or sensors then this usually means good colour separation within the camera. The optics on these cameras are usually better too. The extra image clarity and the good colour separation help improve the quality of the subsequent keying with the camera's output.

White Balance the Camera

White Balance is extremely important after setting up a chroma key studio. The camera must be correctly white balanced to minimize the subject picking up any colour cast (green or blue) from the background. Of course the white balance settings will vary according to the type of lighting you are using, but neutral whites and good skin tone colour are the all-important targets.

To set the white balance you will need a white reference card (or a sheet of white paper). Focus the camera on the reference card and light it evenly using the main light. Set the camera's iris / aperture so that the card is correctly exposed. Use the Auto White Balance (AWB) function, or set the white balance manually so that the card appears white. If you are in any doubt about how to white balance your camera, **please refer to your Camera's instruction manual for more details.**

Lighting

Lighting of your chosen green or blue backdrop is extremely important; the more even the lighting on the backdrop the better the finished result. Lighting setups for the foreground subject will vary according to the effect that you want. For chroma keying backdrops, balanced even lighting with no hotspots or shadow areas is the aim. The easiest way to achieve balanced Chroma key lighting is with a lighting setup that looks similar to this:

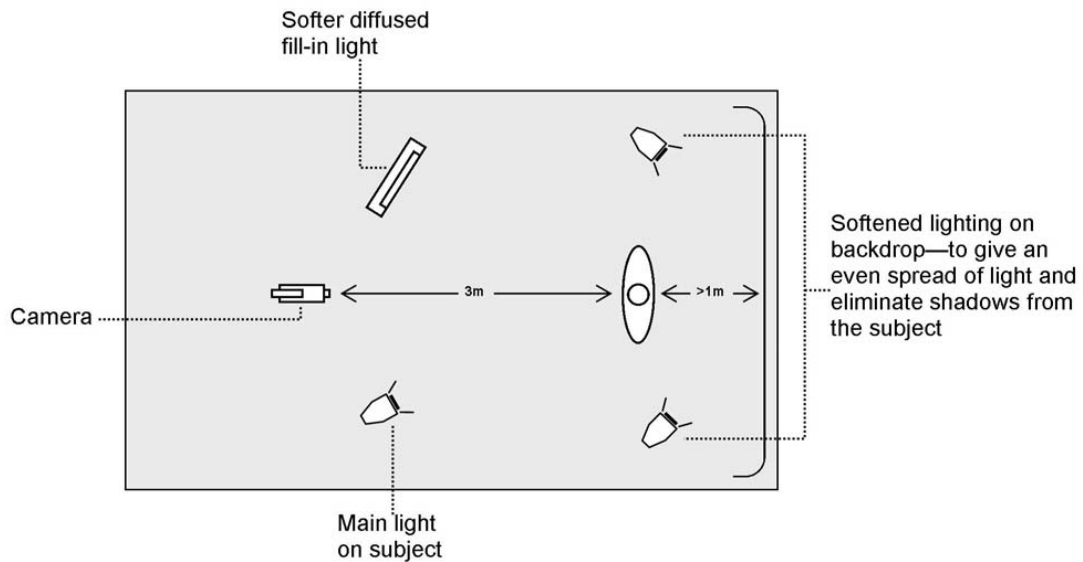

In the diagram, you will see that we recommend a **minimum** of four lights and we keep the subject **more than** 1m away from the backdrop. It is always easier to get more even lighting if the subject is farther away from the backdrop (no shadows). The foreground lighting on the subject will also vary according to the effect that you are looking for.

After the studio set up is complete, connect the camera shooting the speaker on a green backdrop to the SDI Input 1 at the rear of the switcher. To configure the settings that will be used for chroma keying, press the **MENU** button on your HS-3200 control panel to open the OSD menu on the monitor. Follow the steps below to configure the chroma key settings.

1. Open the Keyer sub menu and select Key 1.

Keyer	Keyer	Key 1		
	Keyer Ctrl	Chroma	Self	
		Lift 0%	Gain 1.0	Opac 100%
	Key Source	Input 1	Fill Black	Invert Off
	Mask	Left 0%	Right 0%	
		Top 0%	Bot 0%	

2. Select “**Chroma**” and “**Self**” under “**Keyer Ctrl**” and then select the camera source under “**Key Source**.” In this example, we have selected Input 1, which corresponds to the SDI Input 1 at the rear of the switcher and therefore the port to which the camera is connected.

3. Adjust the left, right, top and bottom values of “**Mask**” to set the chroma key range according to green or blue backdrop size.

4. Open Chroma Sub Menu and adjust the corresponding chroma key parameters. Again in this example, we have selected Input 1, which corresponds to the SDI Input 1 at the rear of the switcher.

Note: Selection of **CK Auto** automatically calculates the best Hue & Luma values for the current Keyer source.

Chroma	Keyer	Key 1		
	Key Source	Input 1		
	CK Setup	CK Auto	Hue 110	Luma 80%
		K Range 160	K Fgnd 10%	K Bgnd 20%
		Hi-Light 0%	Lo-Light 0%	Bg-Supp OFF
	Mask	Left 0%	Right 0%	
		Top 0%	Bot 0%	

The chromakeying parameters are described below:

- **Hue:** This parameter adjusts the color of the chroma key. A typical green screen value will be around 120. Blue screen value will be around 240.
- **Luma:** The **Luma** value relates to how bright or dark the selected key colour or hue is.
- **K Range (Key Range):** **Key Range** sets the range of hues or colors (0 – 360 degrees) that closely match the background color to be keyed. The user can start with a value of 120 degrees and this value can be fine-tuned up or down depending on the setup of the green or blue screen studio.
- **K Fgnd (Key Foreground):** **Key Foreground** adjusts the performance of the chroma key in light or white areas. Apply more **Key Foreground** if the light areas are becoming too transparent.
- **K Bgnd (Key Background):** **Key Background** adjusts the performance of the chroma key in dark or black areas. Apply more **Key Background** if the dark areas are becoming too transparent.
- **Hi-Light:** Hi-light boosts the foreground key in high luminance area.
- **Lo-Light:** Lo-light boosts the foreground key in low luminance area.
- **Bg-Supp:** Turn ON **Background Suppress** removes the Luma (Brightness) of the background from the final image. If the Chroma Key Output is showing Light Edges, then the **Bgnd suppress** can be used to suppress any background Luma that is showing through on these edges.

5. After Chroma Key configuration is complete, close the OSD menu and simply press **KEY 1 PGM** or **KEY 1 PVW** button on the switcher's control panel to place the speaker on **PGM** or **PVW** Screen as shown in the diagram below.

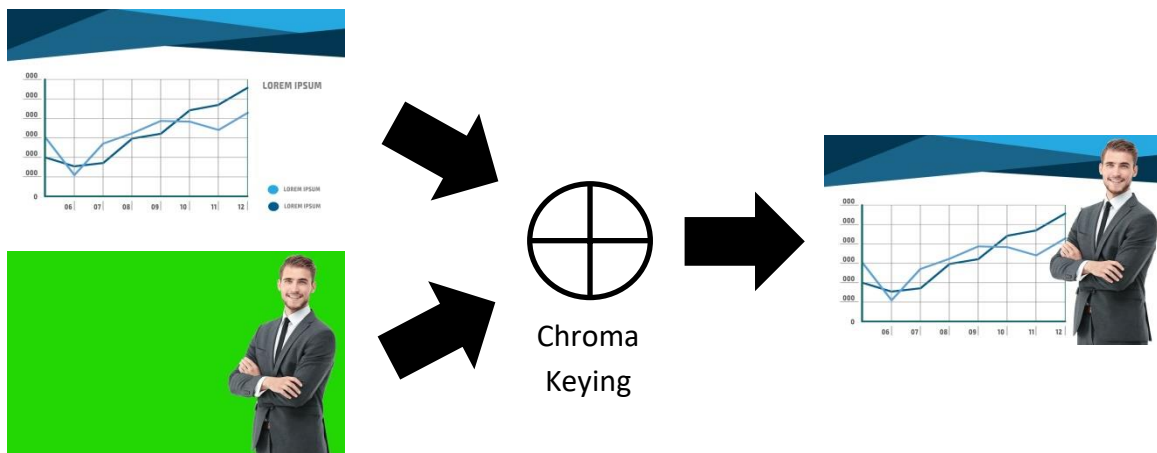

6.4 Displaying a variety of Sources at the same time

The Flex™ output allows the user to show a variety of sources at the same time and these sources can then be fed as one combined image to the HS-3200 Program or Preview outputs.

The Flex™ output could be as simple as one background image and four smaller source images to make a basic Flex™ layout.

Alternatively it could be a lot more complex with a fifth image source making a fifth PIP window. You also have the ability to place a user defined color border around all PIP windows. You can re-size, crop, rotate and position the PIP windows in almost any manner that you wish. With the HS-3200, you will be allowed to display up to eight PIP windows on the Flex™ output.

To configure the Flex™ settings, simply follow the steps outline below.

Basic Flex™ Output (Four PIP Windows)

1. Enable **Flex™** SOURCES on PGM or PVW window (press **SHIFT** and while holding down the **SHIFT** button, press the **FLEX** button). This will display the **Flex™** output layout on the monitor so that you will be able to configure the **Flex™** output while viewing the changes.

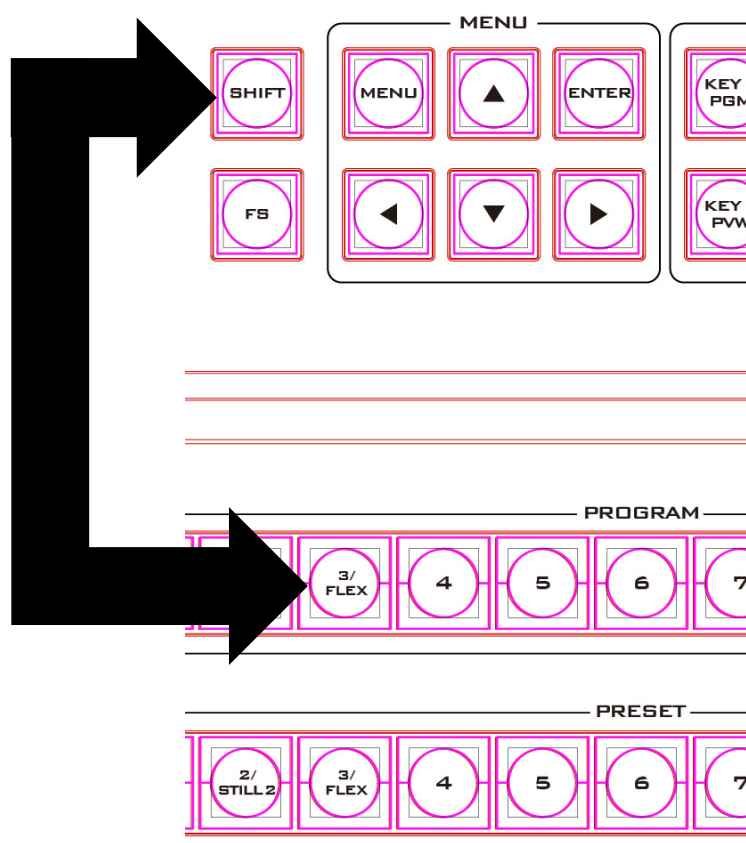

2. Press the **MENU** button on the switcher's control panel to open the OSD menu on the monitor and select **Flex Src** sub menu. On the sub menu that opens, Quick 0-2 are presets for FLEX screen layouts. Select any of the presets to enable the desired preconfigured layout on the screen.

Flex Src	Flex Src Bgnd	Black		
	P-in-P 1 Src	Black		
	P-in-P 2 Src	Black		
	P-in-P 3 Src	Black		
	P-in-P 4 Src	Black		
	Quick	Quick 0	Quick 1	Quick 2

3. The **Flex™** output consists of one background image and four smaller source images overlapped on the background image in four separate individual PIP windows. The options above the **Quick** row allow you to select a signal source for the background image (**FLEX Src Bgnd**) and then assign an image source to the respective **Flex™** sources (**P-in-P 1 Src** to **P-in-P 4 Src**).

4. In order to configure the corresponding FLEX window's size, position, border style, border color, border width and the crop settings, open the P-in-P sub menu and in the **Keyer** option, you will be able to find options **Flex PinP 1 to 4**. Select one of them and adjust the **Flex™ P-in-P** windows accordingly.

P-in-P	Keyer	Flex PinP 1			
	Position	X 20%	Y 10%	Size 40%	
	Border	Normal			
		Luma 100%	Sat 80%	Hue 0	
		Width 2%	Soft 0%	Opac 100%	
	Shade Matte	Luma 100%	Sat 80%	Hue 60	
		Shade Soft 2%	Shade Pos 50	Direction 35	
	Crop	Left 0%	Right 0%	Size 0%	
		Top 0%	Bot 0%		

5. Once configured, save the **Flex™** settings in User Memories for easy access.

After the **Flex™** settings are successfully configured, as depicted in the diagram below, each FLEX window will display the respective source images. Use the **Flex™** feature in different scenarios and apply the proper keying effect accordingly.



Flex™ and Downstream Key: Talk Show and Interview TV Show



Flex™ and Chroma Key: Educational Program



Flex™, Chroma Key, Luma Key and PIP: Cultural Program or Live Sports Program



Assigning a video source to a PIP window using shortcut keys

In addition to assigning a video source to a **Flex™ output window** on the **OSD MENU**, the user can also use shortcut keys to easily switch between different **Flex™ output window sources**. Press and hold **KEY 1-4 PVW** buttons, and the program row will start flashing. Press the program row buttons to switch the **Flex™ output window source**.

Simultaneously Display up to Eight PIP Windows

The HS-3200 allows you to display up to eight PIP windows at the same time. This can be achieved by enabling the **Flex™ output** along with the **four keys equipped on the HS-3200**. Before using this feature, the four keys must be set to PIP mode and the four FLEX

windows must be adjusted and positioned accordingly. The steps outlined below will guide you in configuring the eight PIP windows.

1. Enable **Flex™** SOURCES on PGM or PVW window (press **SHIFT** and while holding down the **SHIFT** button, press the **FLEX** button). This will display the **Flex™** output layout on the monitor so that you will be able to configure the **Flex™** output while viewing the changes.
2. Pre-configure the four **Flex™** sources on the P-in-P sub menu by adjusting the size and position of the corresponding windows. Remember to modify the luma key parameters accordingly.

Note that you can switch the **Flex™** sources on **Flex Src** sub menu.

P-in-P	Keyer	Flex PinP 1					
	Position	X	20%	Y	10%	Size	40%
	Border	Normal					
		Luma	100%	Sat	80%	Hue	0
		Width	2%	Soft	0%	Opac	100%
	Shade Matte	Luma	100%	Sat	80%	Hue	60
		Shade	2%	Shade	50	Direction	35
		Soft		Pos			
	Crop	Left	0%	Right	0%	Size	0%
		Top	0%	Bot	0%		

3. Open the **Keyer** sub menu, set Keyers 1 – 4 to **PIP** mode and enable **Luma Key**.

Keyer	Keyer	Key 1					
	Keyer Ctrl	Luma		P-in-P			
		Lift	0%	Gain	1.0	Opac	100%
	Key Source	Input 1		Fill	Black		
	Mask	Left	0%	Right	0%		
		Top	0%	Bot	0%		

4. Adjust the keyers in the P-in-P sub menu.

P-in-P	Keyer	Key 1					
	Position	X	20%	Y	10%	Size	40%
	Border	Normal					
		Luma	100%	Sat	80%	Hue	0
		Width	2%	Soft	0%	Opac	100%
	Shade Matte	Luma	100%	Sat	80%	Hue	60
		Shade	2%	Shade	50	Direction	35
		Soft		Pos			

	Crop	Left	0%	Right	0%	Size	0%
		Top	0%	Bot	0%		

5. After the **Flex™** output and the four PIP windows are successfully configured, enable the **Flex™** output by pressing the **Flex™** button while holding down the **SHIFT** button, and then press **KEY1 PGM** to **KEY4 PGM** buttons to activate the four PIP windows on the **Program** Output. The diagrams below provide an example of an eight PIP window display.



Chapter 7 Video Streaming

The HS-3200 Portable Video Studio includes a built-in Video Streaming Server (NVS-31) allowing the user to stream and record your program at the same time. From any HDMI input source, the Datavideo NVS-31 generates an H.264 encoded stream compliant with RTSP or RTMP protocols. While encoding the video at bit rates appropriate for live streaming, the Datavideo NVS-31 concurrently records a high-quality MP4 file to an SD card.

7.1 Streaming Network Connection and Setup

This section details how to connect the NVS-31 to a network with or without a DHCP server, and describes how to acquire the NVS-31 IP address.

Finding the NVS-31's current IP address



NVS-2X_IPFinder_20171002_v116

You must first know your NVS-31 device's IP address to access the Web User Interface. Datavideo provides a free Windows based utility called IP Finder to search for devices connected on the same network.

On the computer connected to the NVS-31, first download the utility from the product page of HS-3200. Once downloaded, locate and double click the icon on the left to open the utility shown in the diagram below.

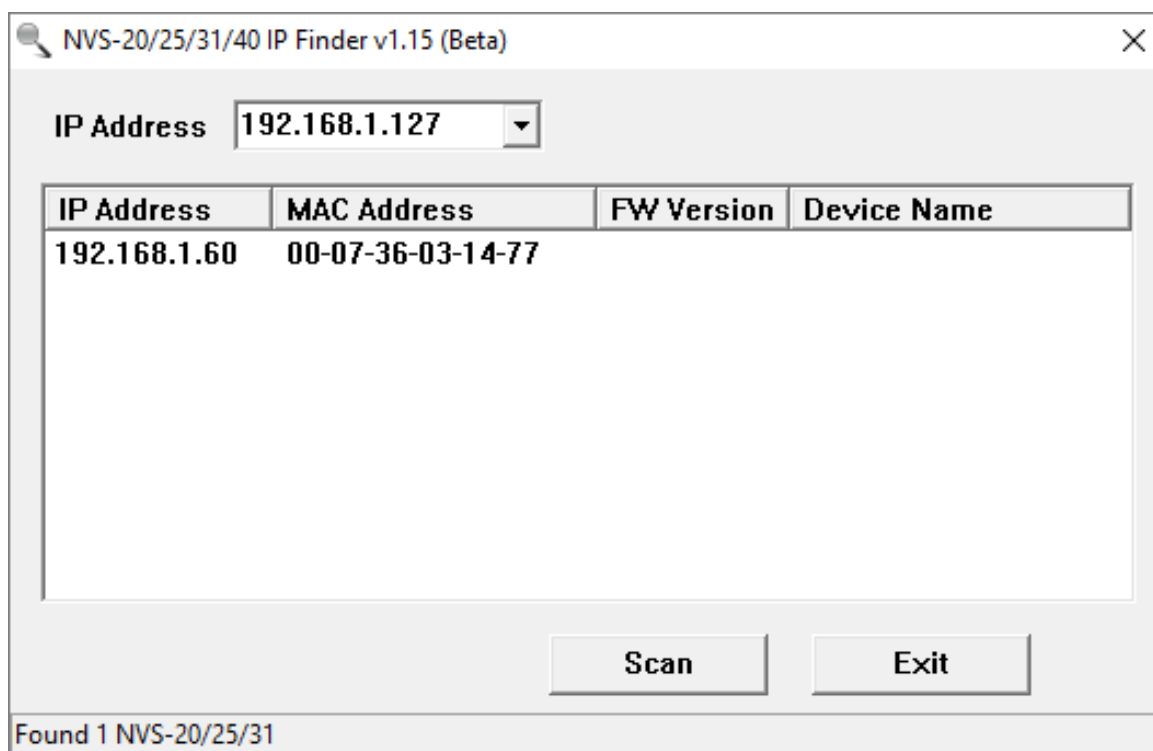

Please note that in order for your computer to communicate with the NVS-31, your computer's IP address must be in the same network range as your NVS-31's IP address. In the above example, change your computer's IP address and subnet mask to the following:

- **IP address** 192.168.1.X
- **Subnet mask** 255.255.0.0

There are basically two ways to establish connection between the NVS-31 and your computer:

- Connect an Ethernet cable from the NVS-31's LAN port directly to your computer's Ethernet port.
- Connect an Ethernet cable from the NVS-31's LAN port to the same network switch as your computer.

Note: If the first method is chosen, make sure to manually assign an IP address to your PC before making attempts to connect to the NVS-31.

7.2 Web User Interface

By now, we have obtained the IP addresses of the computer and the NVS-31. Type the NVS-31's IP address into the address bar of a browser and then hit the **ENTER** button. Login by entering the user name as well as the password into a pop-up dialogue box as shown below.

User Name: admin

Password: 000000

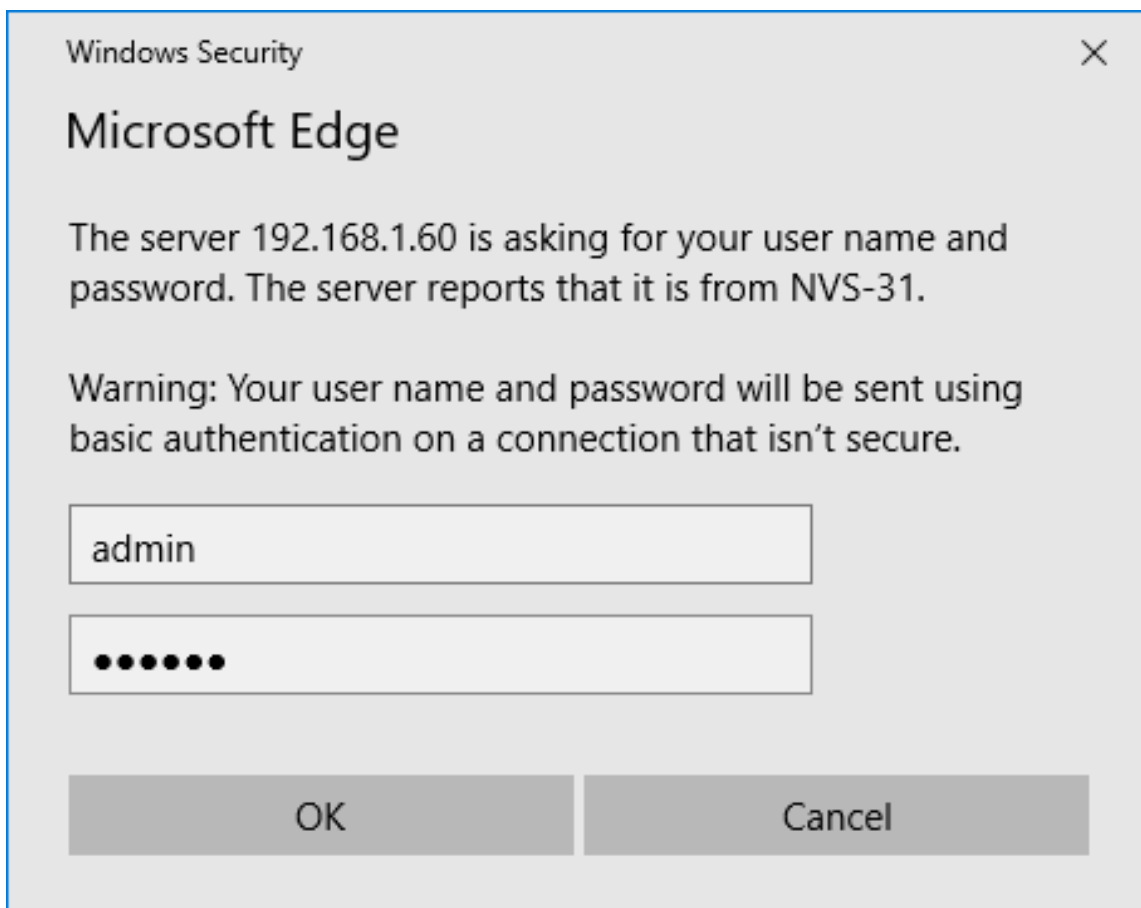

Click **OK** button to login and you will be directed to the **Source** Page as shown below.

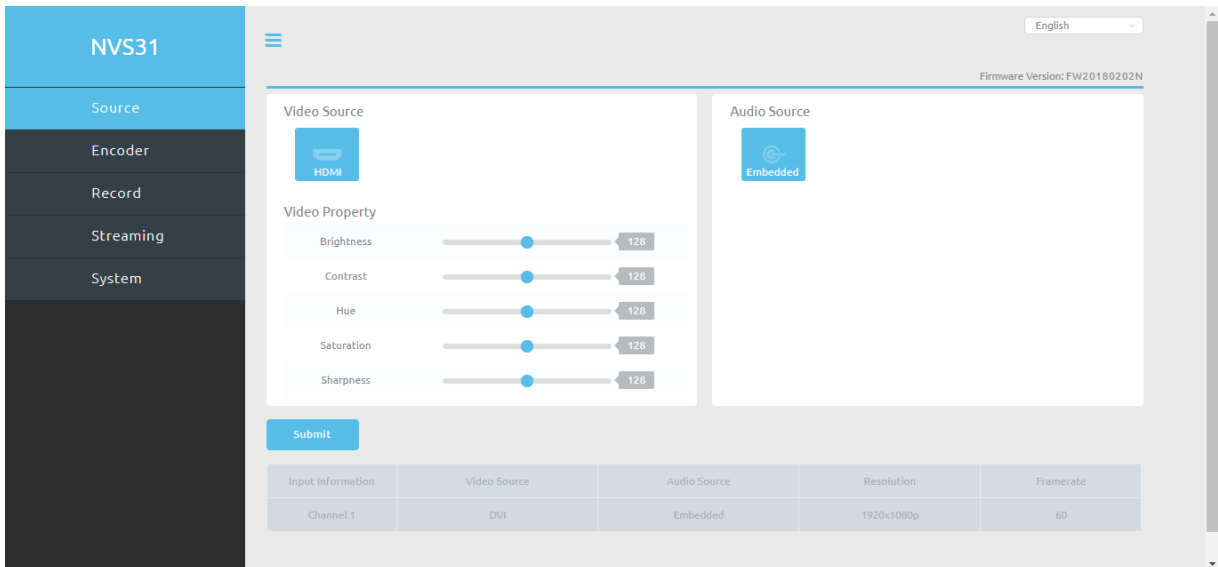

Source

The video source is fixed onto PGM View only. In the **Video Source** column, you will be allowed to adjust video properties such as **Brightness**, **Contrast**, **Hue**, **Saturation** and **Sharpness**. These parameters range from **0** to **255**.

The **Audio Source** column currently indicates that the audio is embedded into HDMI video and is **NOT** reserved for future development.

The **SOURCE** information (Channel No., Video Source, Audio Source, Resolution and Frame Rate) will be displayed in a table at the bottom of the page.

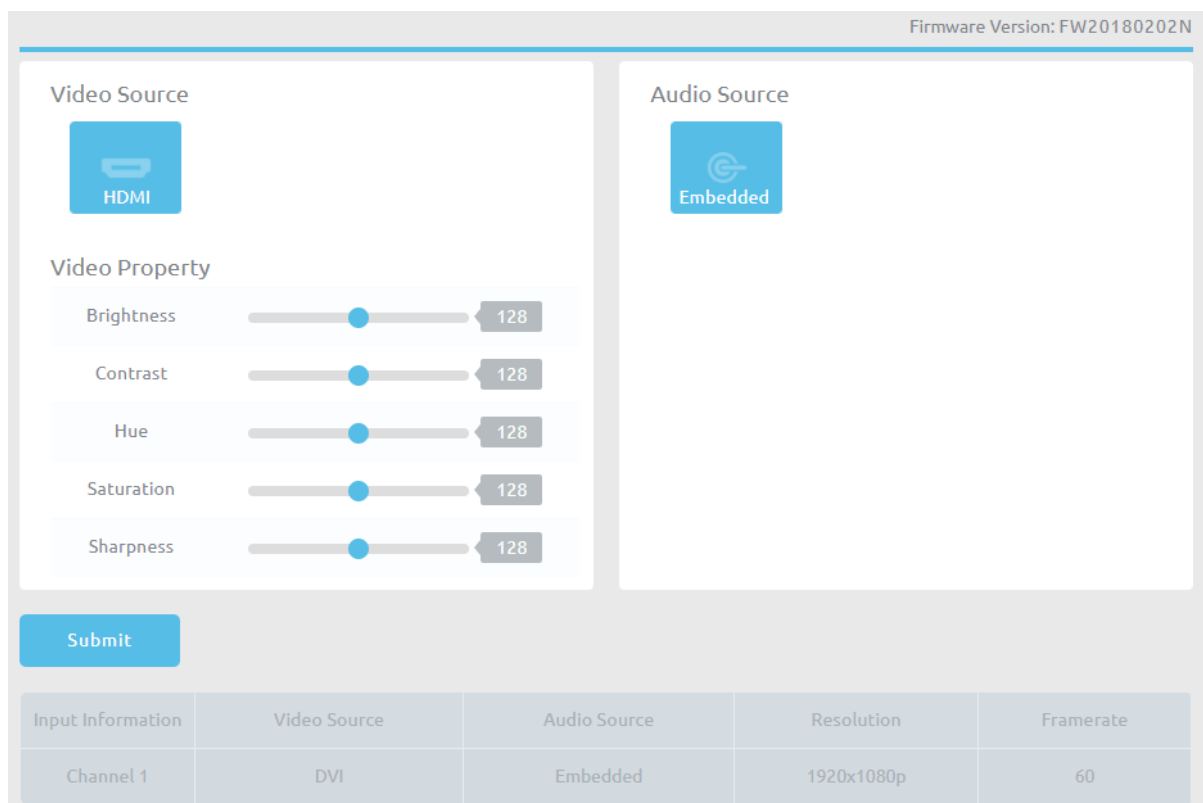

Encoder

An NVS-31 video encoder enables video compression for digital video which will then be used for streaming and recording. However, when choosing your encoding settings for streaming, you should first check your available upload bandwidth. A good rule of thumb is for the bitrate of your stream to use no more than 50% of your available upload bandwidth capacity on a **DEDICATED** line. For example, if the result you get from a speed test shows that you have 2Mbps of upload speed available, your combined audio and video bitrate should not exceed 1Mbps.

The NVS-31 provides the user with two encoders so that you can stream and record videos with different encode settings simultaneously. The Main Encoder and Sub Encoder can be used for recording and streaming in four different combinations as shown in the table below:

Recorder	Streaming Server
Main Encoder	Main Encoder
Main Encoder	Sub Encoder
Sub Encoder	Main Encoder
Sub Encoder	Sub Encoder

Clicking the Encoder tab in the left column will open the Encoder Configuration page on the right as shown in the diagram below.

The screenshot shows the Encoder Configuration page with the following settings:

- Firmware Version:** FW20180202N
- Main Encoder:**
 - Resolution: Same as Input
 - Framerate: 30.00
 - Profile: High
 - Video Bitrate (bps): 16 M
 - Audio Bitrate (bps): 128 K
 - GOP: 60
 - Cropping: X: 0, Y: 0, W: 0, H: 0
- Sub Encoder:**
 - Resolution: Same as Input
 - Framerate: Same as Input
 - Profile: Main
 - Video Bitrate (bps): 16 M
 - Audio Bitrate (bps): 128 K
 - GOP: 60
 - Cropping: X: 0, Y: 0, W: 0, H: 0

A blue **Submit** button is located at the bottom left of the configuration area.

The encoder parameters are described below:

Resolution

The first step of encoder setup is to adjust the image size. It is best to either match your original video source or scale it down. For example, capture at HD 720 and stream at HD 720. Or capture at HD 720 and stream at 540 (high).

You should never be scaling up and streaming at a higher resolution than your original video source. For example, it does not make sense to capture at 720 and stream at 1080. Note

that you will also have no gain in quality and you are using more bandwidth than is necessary for your viewers.

You should also be aware that higher resolutions require greater processing power to encode the stream. Attempting too high of a resolution on too little processing power can result in degraded image quality and corrupted or interrupted streams or recordings.

Available resolutions on the NVS-31 are listed in the table below.

- 1920 x 1080
- 1280 x 720
- 960 x 540
- 720 x 576
- 720 x 480
- 640 x 480
- 320 x 240
- 160 x 128

Frame Rate

Select the Frame Rate after the resolution is selected. Note that frame rates should always match the frame rate of the video source.

- Same as Input
- 60.00
- 50.00
- 30.00
- 25.00
- 20.00
- 15.00
- 10.00
- 5.00
- 1.00

Profile

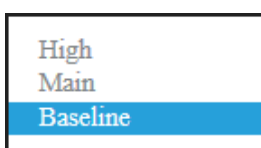

Profile sets the H.264 encoding profile for your stream. The available options are **Baseline**, **Main**, and **High**. Typically, **High** profile provides the best image quality and is suitable in most instances. However, depending on the decoder used when viewing the stream, such as with mobile devices, a Main or Baseline profile may be required.

Video Bitrate (bps)

The bitrate of the video specifies the amount of information stored in the video. The higher the bitrate is, the clearer the video is.

The bitrate ranges from 256K to 16M as shown in the table below.

- 16 M
- 12 M
- 8 M

- 6 M
- 4 M
- 3 M
- 2.5 M
- 2 M
- 1.5 M
- 1 M
- 512 K
- 256 K

Usually high bitrate means good image quality; however, there are also exceptions. For example, SD video may appear acceptable at 1000 Kbps (1M) but HD video is unacceptable at 1000 Kbps. Therefore we recommend the following settings for your video bitrate:

- When NVS-31 is in record-only mode, the recommended video bitrate is 16 Mbps.
- When NVS-31 is in stream-only mode, the recommended video bitrate is 10 Mbps.
- When NVS-31 streams and records simultaneously, sum of the stream and record video bitrates should not exceed 12Mbps.

When streaming, the NVS-31 converts video into data, which are sent across an IP network. High bitrates consume more bandwidth across the IP network. In a gigabit office LAN, high bitrate may not be a concern and Speed/Bandwidth is therefore not the limitation in a NVS-31 application environment.

If your available bandwidth is limited, you should reduce both your resolution and your bitrate accordingly. A good rule of thumb is for the bitrate of your stream to use no more than 50% of your available upload bandwidth capacity on a dedicated line. For example, if the result you get from a speed test shows that you have 2Mbps of upload speed available, your combined audio and video bitrate should not exceed 1Mbps.

Audio Bitrate (bps)

The audio bits consume much less of the overall bandwidth than the video bitrate, usually a negligible amount compared to the video. The NVS-31 offers the user the following audio bitrates at which you may want to stream or record the audio. It is recommended to select 128Kbps or higher.

- 384 K
- 256 K
- 128 K
- 64 K
- 32 K

GOP

GOP pattern with longer GOP length encodes video very efficiently. Shorter GOP lengths usually work better with video that has quick movements, but they do not compress the data rate as much. On the NVS-31, there are 16 GOP sizes available for the user, ranging from 1 to 180.

- 180
- 160
- 140
- 120
- 100
- 60
- 50
- 30
- 25
- 20
- 15
- 10
- 5
- 3
- 2
- 1

Cropping

The cropping feature allows the user to select a confined area of the camera video. X and Y parameters select the center of the video crop. After that, the user can then set W and H values to select the size of the crop.

Cropping

X: Y:

Cropping

W: H:

Record

The **Record Settings** page of the Web User Interface allows you to set the record settings for the NVS-31 device.

Firmware Version: FW20180202N

<h4>Main Record</h4> <p>Encoder Source <input type="text" value="Sub Encoder"/></p> <p>File Name <input type="text" value="sub record"/></p> <p>File Size Loop Recording <input type="text" value="4G"/> <input type="text" value="YES"/></p> <p>Recording File <input type="text" value="sub record_0005.mp4"/></p>	<h4>Storage Information</h4> <p>Vendor: <input type="text" value="Unknown"/></p> <p>Product: <input type="text" value="USB Storage"/></p> <p>Capacity: <input type="text" value="0.00G/12.26G"/></p> <p>Storage Format <input type="text" value="FAT32"/></p>
---	---

The parameters on the **Record** page are described as follows:

Main Record Column

The **Main Record** column contains settings for the recorder.

Encoder Source

Select the encoder for your recorder; there are MAIN and SUB encoders.

File Name

In the text bar, enter the file name of the recorded video.

File Size

Select the maximum record file size

Loop Recording

Loop recording allows the user record continuously to the disk. Select YES to enable loop recording and NO to disable.

Recording File

This text box displays the recording file name.

Storage Information Column

In this column, the user will be able to view the USB drive information such as the **Vendor Name, Product Type, Disk Capacity** and **Disk Format Type**.

Note: The SD Card will be formatted immediately as soon as the Format USB Disk button is clicked.

Storage Content

Disk contents are displayed here, **providing** an overview of different directories and files.

Storage Content

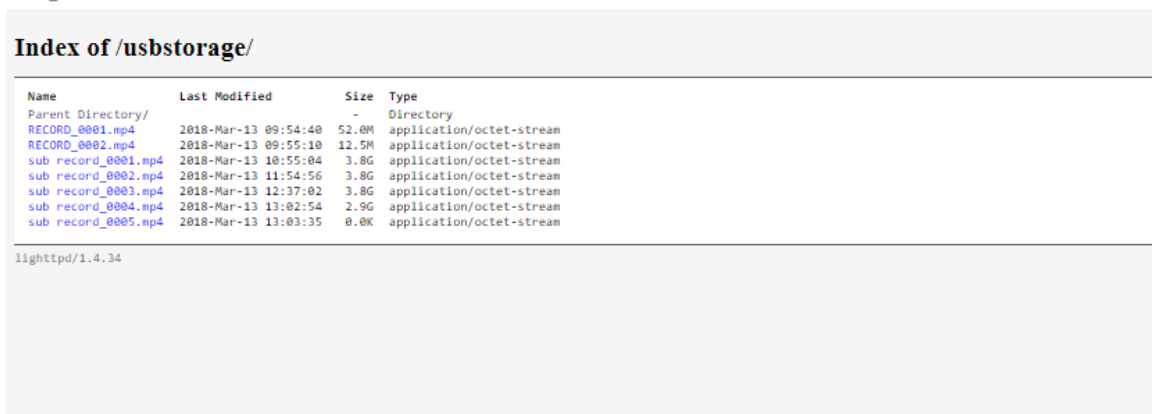

The screenshot shows a directory listing for the path /usbstorage/. The listing includes a table with columns for Name, Last Modified, Size, and Type. The entries are as follows:

Name	Last Modified	Size	Type
Parent Directory/		-	Directory
RECORD_0001.mp4	2018-Mar-13 09:54:40	52.0M	application/octet-stream
RECORD_0002.mp4	2018-Mar-13 09:55:10	12.5M	application/octet-stream
sub record_0001.mp4	2018-Mar-13 10:55:04	3.8G	application/octet-stream
sub record_0002.mp4	2018-Mar-13 11:54:56	3.8G	application/octet-stream
sub record_0003.mp4	2018-Mar-13 12:37:02	3.8G	application/octet-stream
sub record_0004.mp4	2018-Mar-13 13:02:54	2.9G	application/octet-stream
sub record_0005.mp4	2018-Mar-13 13:03:35	0.0K	application/octet-stream

lighttpd/1.4.34

Streaming

The NVS-31 provides RTSP and RTMP streaming protocols for use on Adobe Media Servers, Wowza Media Servers, software video players such as QuickTime and VLC, or any of the popular Content Delivery Networks (CDNs), such as YouTube Live and Ustream.

RTSP Mode

Main Streaming

Stream Type
RTSP

Encoder Source
Sub Encoder

RTSP Port
554

RTSP HTTP Port
8000

RTSP Account

RTSP Password

Start Stream Stop Stream

In RTSP mode, the NVS-31 acts as a streaming server to which clients can connect via a media server, software video player, or CDN that supports the RTSP streaming protocol. If you want to stream to more than a handful of clients, we recommend using a dedicated media server to send streams to clients.

To configure the RTSP stream server, select the **Encoder Source** first and then enter the respective port numbers. To start streaming, simply click the “**Start Stream**” button after the server is configured.

As soon as the stream is started successfully, you will be able to see the RTSP view link (**Play URL**) displayed as shown in the diagram below. To view the stream, open the **Play URL** in VLC Video Player.

Main Streaming

Stream Type
RTSP

Encoder Source
Sub Encoder

RTSP Port
554

RTSP HTTP Port
8000

RTSP Account

RTSP Password

Play URL
rtsp://192.168.1.151:554/live2

Play URL
rtsp://192.168.1.151:8000/live2

Start Stream Stop Stream

Open VLC Media Player and click “Open Network Stream.”

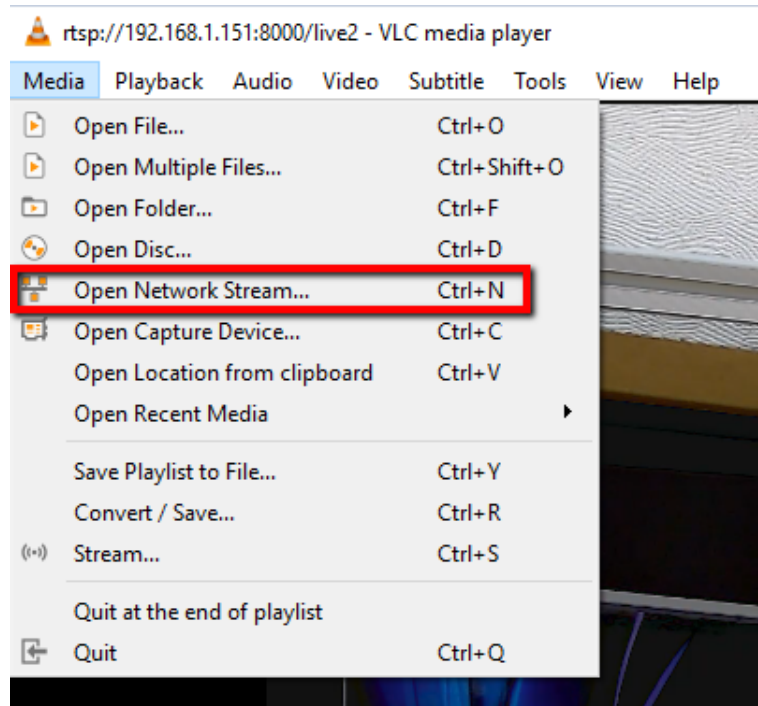

On the Open Media window, enter the Play URL “rtsp://192.168.1.151:8000/live” and then click the **Play** button to open the view window.

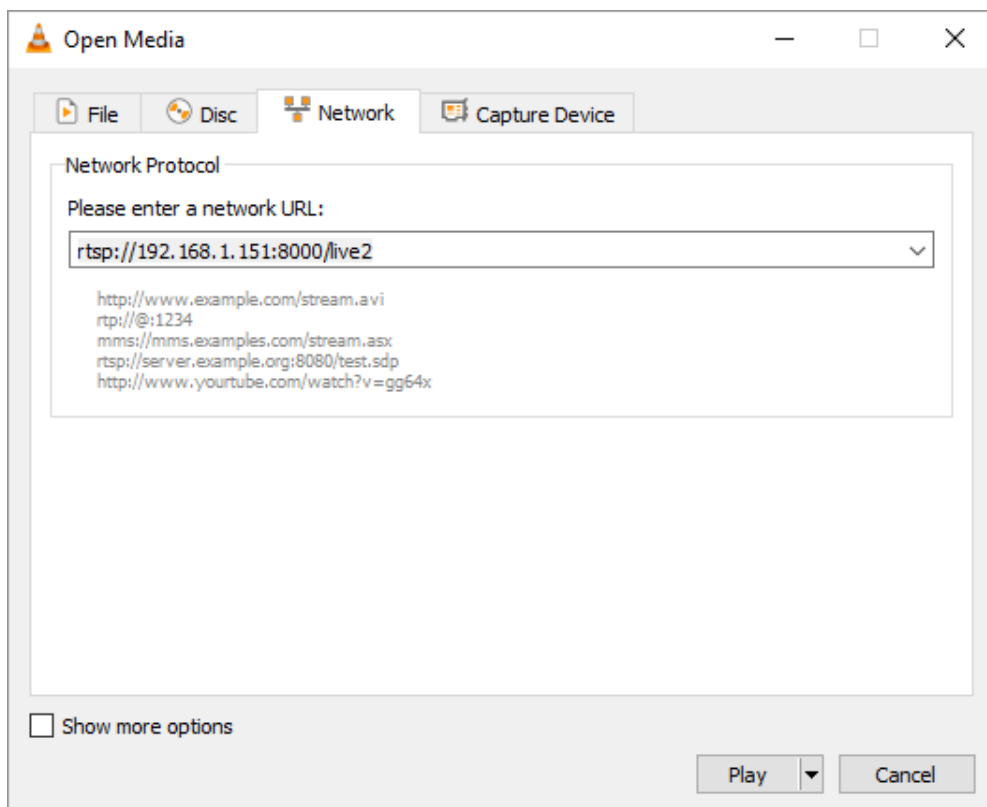

RTMP Mode

In RTMP mode, the NVS-31 can only send one data stream to one CDN or media server that supports the RTMP streaming protocol. On the streaming setup page, select the **Encoder**

Source first and then enter the respective RTMP stream information. To start streaming, simply click the “**Start Stream**” button after the **RTMP mode** is configured.

The screenshot shows the 'Main Streaming' configuration interface. It features a 'Stream Type' dropdown menu set to 'RTMP'. Below it is an 'Encoder Source' dropdown menu set to 'Main Encoder'. The 'RTMP URL 1' field contains the text 'rtmp://a.rtmp.youtube.com/live2'. There are three input fields: 'StreamName 1' with the value 'r40c-gj3r-yqf6-08kq', 'Account 1' which is empty, and 'Password 1' which is empty. At the bottom of the form are two buttons: 'Start Stream' and 'Stop Stream'.

TS Mode

In MPEG transport stream mode, the NVS-31 can send stream data directly to the viewer. On the streaming setup page, select the **Encoder Source** first and then enter the TS IP address and the TS port number. To start streaming, simply click the “**Start Stream**” button after the **TS mode** is configured.

The screenshot shows the 'Main Streaming' configuration interface for TS mode. The 'Stream Type' dropdown menu is set to 'TS'. The 'Encoder Source' dropdown menu is set to 'Main Encoder'. There are two input fields: 'TS IP' with the value '239.100.100.100' and 'TS Port' with the value '12345'. At the bottom of the form are two buttons: 'Start Stream' and 'Stop Stream'.

System

The NVS-31 also allows the user to configure the system's network settings, set account login credentials, update the device firmware, select the time, restore the factory defaults and reboot the system.

The screenshot displays the NVS-31 web interface with the following sections:

- Network Setting:** DHCP is set to 'Enable'. Static IP is 192.168.1.60, Subnet Mask is 255.255.255.0, Default Gateway is 192.168.1.254, Primary DNS is 192.168.1.1, Secondary DNS is 8.8.8.8, and MAC ADDRESS is 00:07:36:03:C0:0A.
- Time Setting:** NTP is time.windows.com, Date is 2018-03-14, and Time is 14:04:22.
- Firmware Update:** Shows a 'File Path' field and two red warning messages: 'Please Stop Recording for Firmware Update!' and 'Please Stop Streaming for Firmware Update!'. There are 'Browse' and 'Update' buttons.
- Account Setup:** Fields for 'Original Account' and 'Original Password' with a 'Submit' button.
- System Related:** 'Restore to Default' and 'System Reboot' buttons.

Network Setting

You are allowed to connect the NVS-31 to a network in DHCP or Static IP mode. Disable DHCP server if you want to connect to the NVS-31 on a fixed IP. An example of Static IP mode configuration is provided below:

The screenshot shows the 'Network Setting' section with the following configuration:

- DHCP: Disable
- Static IP: 192.168.1.60
- Subnet Mask: 255.255.255.0
- Default Gateway: 192.168.1.254
- Primary DNS: 192.168.1.1
- Secondary DNS: 8.8.8.8
- MAC ADDRESS: 00:07:36:03:C0:0A

- Static IP: 192.168.1.60
- Subnet Mask: 255.255.255.0
- Default Gateway: 192.168.1.254
- Primary DNS: 192.168.1.1
- Secondary DNS: 8.8.8.8

Note: If you do not remember the IP address assigned to the device, follow the steps below to reset the network settings:

- Turn off the machine.
- Press the **RECORD** and **STREAM** buttons simultaneously and switch ON the device.
- Wait for 5 seconds approximately and release the button push as soon as the two buttons light up.
- The default IP address is **192.168.1.60**.

Account Setup

Change the password in the Account Setup.

Account Setup

Original Account

Original Password

Submit

Firmware Update

From time to time Datavideo may release new firmware to either add new features or to fix reported bugs in the current NVS-31 firmware. To update the firmware, you must first click the Browse button to search for the firmware file on the disk.

Firmware Update

File Path

Browse Update

Please note that if the device is recording or streaming, you have to turn the features off in order to perform the firmware update.

File Path

Please Stop Recording for Firmware Update!

Please Stop Streaming for Firmware Update!

Once the firmware file is selected, you will see the prompt display as shown below indicating that the file is being uploaded.

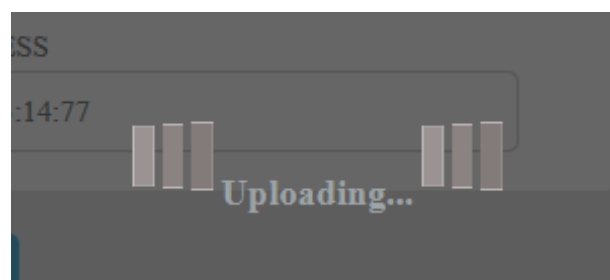

You will see the message shown below after the file upload is complete.

File uploading success, Please click update!

Once the file is uploaded successfully, click the **Update** button to start the update.

Firmware Update

File Path

FW20171229N_NVS31

Browse

Update

The device will reboot itself after the firmware is successfully updated.

Preparing for Rebooting!

48 Secs

Time Setting

Enter the device's time setting for recording purpose. Specify your time server in the **NTP** field.

Time Setting

NTP

time.windows.com

Date

2018-03-14

Time

10:33:39

Submit

System Related

Click the **Restore to Default** button to reset the NVS-31 to factory defaults. To reboot the NVS-31, simply click the **System Reboot** button.

System Related

Restore to Default

System Reboot

Chapter 8 Monitor OSD MENU



The HS-3200 Monitor can be configured via an on screen menu. When the **MENU** button is pressed the Main Menu list is displayed on the monitor.

This section covers the Menu options in the order that they appear on the monitor. These settings may also appear in more detail elsewhere in this instruction manual. Options may vary depending on the firmware version in use.

Once the chosen setting has been confirmed with the **ENTER** button, it is stored within the switcher's non-volatile memory.

Main Options	Sub Options	Parameters	Parameters
MAIN ADJUST	BRIGHTNESS	0~100	
	CONTRAST	0~100	
	SHARPNESS	0~100	
	SATURATION	0~100	
	TINT	0~100	
	BACK LIGHT	0~100	
	NR	HIGH / MID / LOW / OFF	
	MPEG NR	HIGH / LOW / OFF	
	VOLUME	0~100	
	EXIT		
COLOR	6500		
	9300		
	7500		
	USER COLOR	RED	0~100
		GREEN	0~100
		BLUE	0~100
EXIT			
SCAN SETTING	UNDER SCAN	full image	
	OVER SCAN	cropped image	
INFORMATION	H. FREQUENCY		
	V. FREQUENCY		
	RESOLUTION		
	VER.		
LANGUAGE	English [default]		
	Francis		
	Deutsch		
	Español		
	Italiano		
	Dutch		
	Português		
	Russian		
EXIT			
SPECIAL FUNCTION	OSD TIMOUT	5-120 SEC	
	FRAME RATIO	80 / 90 / OFF	

	4:3 MARK LINE	ON / OFF	
	CENTRAL MARK	ON / OFF	
	CINEMA ZONE MARK	ON / OFF	
	EXIT		
FACTORY RESET			
EXIT			

8.1 Main Adjust

The first menu option is the **MAIN ADJUST**.

To access the MAIN ADJUST sub-menu, press enter and the Brightness sub-option will be highlighted.

To adjust **BRIGHTNESS** press Enter again. Use the Up / Down buttons to change the setting and then press Enter to store the new value and return to the main menu.

Use the Up / Down buttons to select a different setting (Brightness, Contrast, Saturation, Sharpness, TINT and etc). Follow the same procedure to set other values.

8.2 Color

Press the MENU button to access the menu and use the Up / Down buttons to move to the **COLOR** option so that it is highlighted. Press the **ENTER** button to open the COLOR sub-menu.

To access the selected color setting, press **ENTER** again.

Use the Up / Down buttons to navigate the available color settings.

You can choose:

- 7500
- 9300
- 6500
- USER COLOR

8.3 Information

The **System Information** Menu displays Horizontal Frequency, Vertical Frequency, Resolution and the monitor's version of firmware.

Once selected, the information will be displayed as follows:

You will see:

H. FREQUENCY	33.7KHZ
V. FREQUENCY	60.0HZ
RESOLUTION	1920X1080I
VER.	0.11

8.4 Special Function

The Special Function Sub-Menu has settings for the **OSD TIMEOUT**, **Frame Ratio**, **4:3 MARK LINE**, **Central Mark**, and **Cinema Zone Mark**.

To access the selected setting press the **ENTER** button.

Use the Up / Down buttons to navigate the available options.

You can choose:	OSD TIMEOUT	5-120 SEC
	FRAME RATIO	90 / 80 / OFF
	4:3 MARK LINE	ON / OFF
	CENTRAL MARK	ON / OFF
	CINEMA ZONE MARK	ON / OFF

8.5 Factory Reset

The monitor menu offers a Factory Reset option, which will return all the settings of the monitor to the factory defaults

To reset the monitor press the MENU button and then use the UP / Down button to navigate to **FACTORY RESET** option. Press **ENTER** again to reset the monitor. After a few seconds the monitor will be reset.

Chapter 9 Appendices

Appendix 1 Tally Outputs

The HS-3200 has a D-sub 25 pin female tally output port. These connections provide bi-colour tally information to a number of other Datavideo products, such as the ITC-100 eight channel talkback system and the TLM range of LCD Monitors.

These ports are open collector ports and as such do not provide power to tally light circuits.

Dielectric strength: Max. DC 24V

Current: Max. 50mA

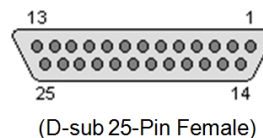

The pin outputs are defined as follows:

Pin No.	Signal name	Input/Output	Signal Description
1	Program 1	Open collector output	Tally output of input video Program 1
2	Program 2	Open collector output	Tally output of input video Program 2
3	Program 3	Open collector output	Tally output of input video Program 3
4	Program 4	Open collector output	Tally output of input video Program 4
5	Program 5	Open collector output	Tally output of input video Program 5
6	Program 6	Open collector output	Tally output of input video Program 6
7	Program 7	Open collector output	Tally output of input video Program 7
8	Program 8	Open collector output	Tally output of input video Program 8
9	Program 9	Open collector output	Tally output of input video Program 9
10	Program 10	Open collector output	Tally output of input video Program 10
11	Program 11	Open collector output	Tally output of input video Program 11
12	Program 12	Open collector output	Tally output of input video Program 12
13	GND	Ground	Ground
14	Preset 1	Open collector output	Tally output of input video Preset 1
15	Preset 2	Open collector output	Tally output of input video Preset 2
16	Preset 3	Open collector output	Tally output of input video Preset 3
17	Preset 4	Open collector output	Tally output of input video Preset 4
18	Preset 5	Open collector output	Tally output of input video Preset 5
19	Preset 6	Open collector output	Tally output of input video Preset 6
20	Preset 7	Open collector output	Tally output of input video Preset 7
21	Preset 8	Open collector output	Tally output of input video Preset 8
22	Preset 9	Open collector output	Tally output of input video Preset 9
23	Preset 10	Open collector output	Tally output of input video Preset 10
24	Preset 11	Open collector output	Tally output of input video Preset 11
25	Preset 12	Open collector output	Tally output of input video Preset 12

Example of tally connections

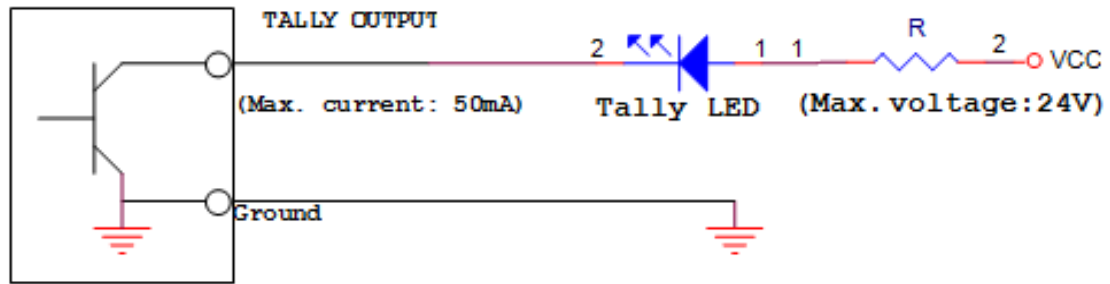

Appendix 2 GPI / GPO Connections

The HS-3200 can control external recorder/playback devices like the HDR-45 and HDR-55 via a simple contact closure GPI / GPO switch.

The GPI interface is a 3.5mm Jack Socket which is situated on the rear panel of the HS-3200. Contact closure between the Outer and Inner contacts on the jack plug will trigger a user selected event. Power is supplied by the HS-3200 and is less than 5V DC.

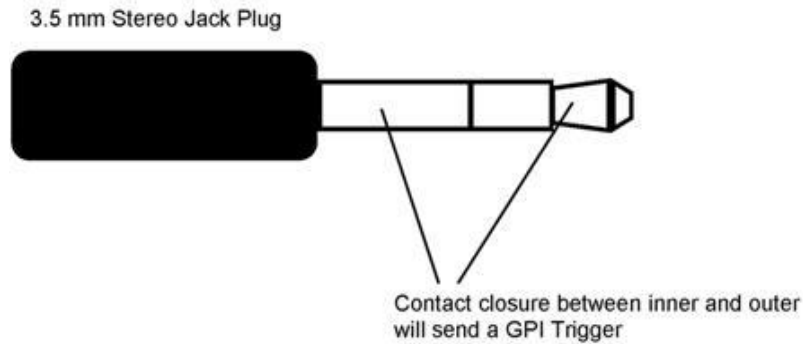

This GPI socket can also be used as a GPO socket to trigger record or playback events with other equipment such as the Datavideo HDR-70 recorder.

SAFETY FIRST The cabling required needs to be designed specifically to connect the HS-3200 to the chosen record or playback device as they are not all the same. The cabling required can be made by yourself or a competent technician. Please speak with your Dealer or local Datavideo office to get further help and advice.

Appendix 3 Firmware Update

Datavideo usually releases new firmware containing new features or reported bug fixes from time to time. Customers can either download the HS-3200 firmware as they wish or contact their local dealer or reseller for assistance.

This section outlines the firmware upgrade process which should take ***approximately 1 hour 20 minutes to complete.***

The existing HS-3200 settings should persist through the *firmware upgrade process, which should not be interrupted once started* as this could result in a non-responsive unit.

Successful firmware upgrade on HS-3200 requires:

- PC or laptop
- USB drive
- Access to the Internet for software download

To update the HS-3200 firmware:

1. Download the latest firmware and the update tool from the path below.

www.datavideo.com → products → Mobile Studios → HS-3200 → Downloads → Latest Firmware

2. Decompress the downloaded files.
3. Insert the USB drive into the PC or laptop and format the drive to FAT or FAT32 system. Save the latest firmware on the drive.
4. Remove the USB drive from the PC or laptop.
5. Insert the USB drive into the **F/W Upgrade** port at the rear of the HS-3200 switcher.
6. Press the **MENU** button on the HS-3200 control panel to open the OSD menu.
7. At the bottom of the **Main Menu**, enter the **SETUP** sub menu.
8. Under the **Software** option, select “**Upgrade**” and press the **ENTER** button to confirm.
9. If you see “**Upgrade**” against a red background, it means the switcher is being updated.
10. When you see red turned to green, it means the firmware upgrade is successful.
11. Reboot the HS-3200 switcher to complete the upgrade.

T-Bar Re-Calibration

After the firmware update of the switcher it will be necessary to re-calibrate the T-Bar to get it working correctly.

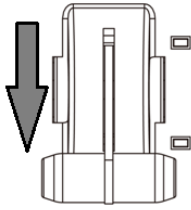

1. Move the **T-Bar** to its **lowest position**.

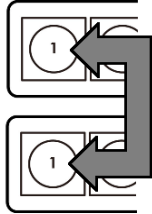

2. **Power OFF** the HS-3200 switcher.

3. Press and **hold down button 1 on both the Program and Preset rows** of the switcher's keyboard.

4. **Power ON** the HS-3200 switcher while **still holding down the buttons** in step 3.

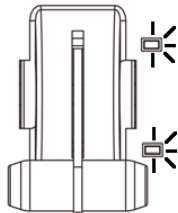

5. The switcher will start but the keyboard lights will remain dead except for the T-Bar progress LEDs. When these **LEDs flash ON and OFF** release the buttons from step 3.

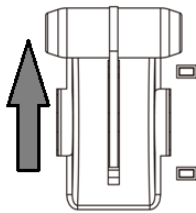

6. Move the **T-Bar to almost its top position (2-3mm away)** and then press the **CUT button**.

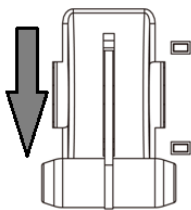

7. Move the **T-Bar back to almost its lowest position (2-3mm away)** and then press the **AUTO TAKE button**.



8. To exit the calibration procedure, press the **CLOCK button**.

9. Ensure the **TIMER button** is **OFF**.

10. Test the T-Bar. If necessary change the **T-Bar Mode** in the **OSD MENU** options.

Appendix 4 Frequently-Asked Questions

This section describes problems that you may encounter while using the HS-3200. If you have any questions, please refer to related sections and follow all suggested solutions. If problem still exists, please contact your distributor or the service center.

No.	Problems	Solutions
1	Grabbed picture is distorted or contains noise.	Successfully grabbed pictures to Still 1 and 2 will be distorted or appear noisy if switched to different video standards.
2	Loaded still picture contains noise.	Still pictures will be distorted or appear noisy if switched to different video standards.
3	What kind of files can be saved on the HS-3200 and is there any limitations?	You can save still pictures, user memory, clips and logos to the HS-3200's memory but the maximum storage space is limited to 1000 frames.
4	One of the FLEX sources is not displayed in the FLEX windows.	The maximum Flex TM output size is 1080p full screen. If exceeded, one Flex source will not be displayed.
5	HS-3200 is unable to save the last settings into its nonvolatile memory.	The Last Memory feature will be enabled upon entering and exiting the OSD menu. Only shut down the machine after 10 seconds after the OSD menu is closed (It takes 10 seconds for the HS-3200 to finish saving the last settings to the memory).

Appendix 5 Dimensions & Weight

Main Unit

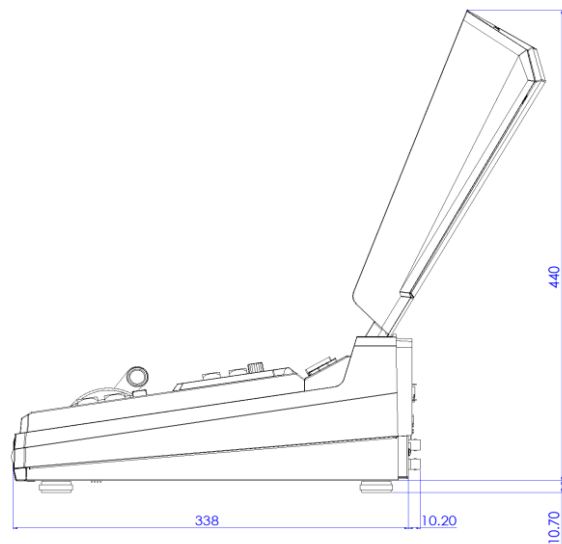
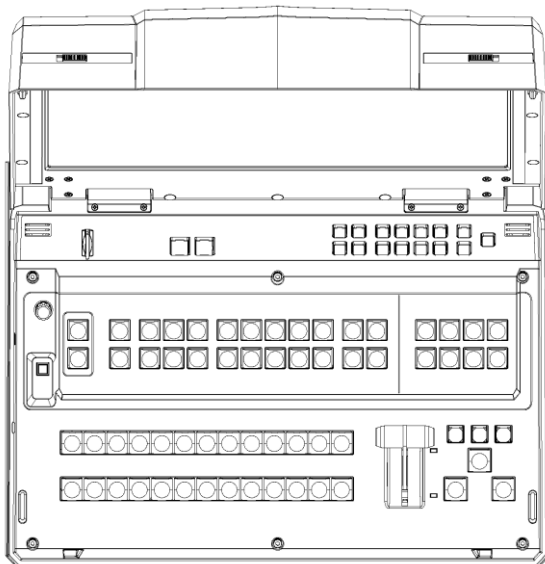
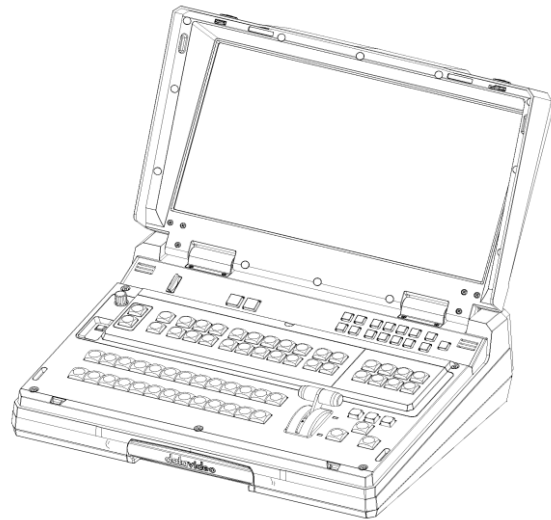
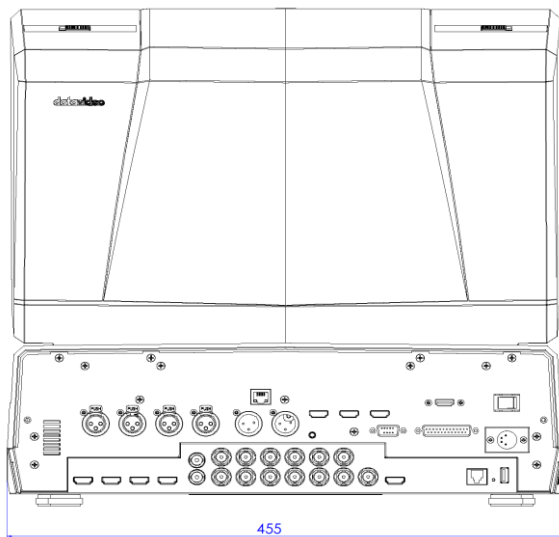

All measurements in millimeters (mm)

Weight: 8.2 Kg

Appendix 6 Specifications

Model Name	HS-3200
Product Name	HD 12-Channel Portable Video Streaming Studio
Video Standard	Full HD
Video Format	1080p 50/59.94/60Hz 1080i 50/59.94/60Hz 720p 50/59.94/60Hz
Input Routable / Crosspoint	All 12, repeatable
Video Input	8x SDI 4x HDMI
Computer Graphical Interface	4 via HDMI
Down-Converted Output	N/A
Video Output	5 x SDI and 1 x HDMI assignable: <ul style="list-style-type: none"> • Multiview • Program (PGM) • Preview (PVW) • Program + DSK • Clean Program • Clean Preview • Input 1 – 12 • Still 1 • Still 2 • Flex source 3 x HDMI PGM only
Audio Input	4 x Balanced XLR
Audio Output	2 x Balanced XLR
Embedded Audio Support	Input: Up to 16 channels Output: 4 channels
Audio Delay Calibration	Up to 16 frames
A+V Switching	Yes
USK	4
DSK	2 x DSK supporting Luma key & Linear key (Key / Fill)
Picture in Picture	8 (4 x PIP, 4 x Flex Source)
Logo Insertion	2
Built-in Audio Mixer	N/A

Built-in Monitor Display	17.3" HD TFT LED backlit, 1920x1080 pix
Built-in Intercom & Tally	N/A
Streaming Video Encode	H.264 / AVC, Main/ High Profile Configurable Bit-rate up to 10Mbps
Streaming Audio Encode	AAC-LC Configurable bitrate ranging from 32Kbps to 384Kbps Sampling rate: 48KHz, 16bit
Streaming Protocol	TS over TCP/UDP (unicast & multicast) RTSP over HTTP/TCP/UDP (RTSP Elementary Streaming) RTMP (Publish)
Streaming Control	Web browser UI for configuration and control Socket commands
Recording File System	FAT, exFAT, NTFS
Recording File Format	MP4
Recording Setting Control	Web UI for system configuration and control
Dimensions (LxWxH)	455 x 355 x 134 mm
Weight	17.8 lbs (8.1 Kg), Reinforce Plastic Case
Accessory	CB-22H/23H/46/47/60/61/62
Operating Temperature	0°C - 50°C [32°F - 122°F]
Storage Humidity	10% - 80%
Storage Temperature	-10 - 60°C

NOTES

Service & Support

It is our goal to make owning and using Datavideo products a satisfying experience. Our support staff is available to assist you to set up and operate your system. Contact your local office for specific support requests. Plus, please visit www.datavideo.com to access our FAQ section.

China Shanghai
Datavideo Technologies China Co
601, Building 10, No. 1228,
Rd. Jiangchang,
Jingan District, Shanghai
Tel: +86 21-5603 6599
Fax: +86 21-5603 6770
E-mail: service@datavideo.cn

China Beijing
Datavideo Technologies China Co
No. 812, Building B, Wankai Center,
No. 316, Wan Feng Road, Fengtai District,
Beijing, China
Tel: +86 10-8586 9034
Fax: +86 10-8586 9074
E-mail: service@datavideo.cn

China Chengdu
Datavideo Technologies China Co
B-823, Meinian square, No. 1388,
Middle of Tianfu Avenue, Gaoxin District,
Chengdu, Sichuan
Tel: +86 28-8613 7786
Fax: +86 28-8513 6486
E-mail: service@datavideo.cn

China Fuzhou
Datavideo Technologies China Co
A1-2318-19 Room, No. 8, Aojiang Road,
Taijiang District, Fuzhou, Fujian, China
Tel: 0591-83211756 · 0591-83210187
Fax: 0591-83211262
E-mail: service@datavideo.cn

China Jinan
Datavideo Technologies China Co
902, No. 1 business building,
Xiangtai Square, No. 129,
Yingxiongshan Road, Shizhong District,
Jinan City, Shandong Province, China
Tel: +86 531-8607 8813
E-mail: service@datavideo.cn

Hong Kong
Datavideo Hong Kong Ltd
G/F., 26 Cross Lane
Wanchai, Hong Kong
Tel: +852-2833-1981
Fax: +852-2833-9916
E-mail: info@datavideo.com.hk

India Noida
Datavideo India Noida
A-132, Sec-63, Noida-201307,
India
Tel: +91-0120-2427337
Fax: +91-0120-2427338
E-mail: sales@datavideo.in

India Kochi
Datavideo India Kochi
2nd Floor- North Wing, Govardhan Building,
Opp. NCC Group Headquarters, Chittoor Road,
Cochin- 682035
Tel: +91 4844-025336
Fax: +91 4844-047696
E-mail: sales@datavideo.in

Netherlands
Datavideo Technologies Europe BV
Floridadreef 106
3565 AM Utrecht,
The Netherlands
Tel: +31-30-261-96-56
Fax: +31-30-261-96-57
E-mail: info@datavideo.nl

Singapore
Datavideo Visual Technology(S) Pte Ltd
No. 178 Paya Lebar Road #06-07
Singapore 409030
Tel: +65-6749 6866
Fax: +65-6749 3266
E-mail: info@datavideovirtualset.com

Singapore
Datavideo Technologies (S) PTE Ltd
No. 178 Paya Lebar Road #06-03
Singapore 409030
Tel: +65-6749 6866
Fax: +65-6749 3266
E-mail: sales@datavideo.sg

Taiwan
Datavideo Technologies Co. Ltd
10F. No. 176, Jian 1st Rd., Chung Ho
District, New Taipei City 235, Taiwan
Tel: +886-2-8227-2888
Fax: +886-2-8227-2777
E-mail: service@datavideo.com.tw

United States
Datavideo Corporation
7048 Elmer Avenue.
Whittier, CA 90602,
U.S.A.
Tel: +1-562-696 2324
Fax: +1-562-698 6930
E-mail: sales@datavideo.com

United Kingdom
Datavideo UK Limited
Brookfield House, Brookfield Industrial
Estate, Peakdale Road, Glossop,
Derbyshire, SK13 6LQ
Tel: +44-1457 851 000
Fax: +44-1457 850 964
E-mail: sales@datavideo.co.uk

France
Datavideo France s.a.r.l.
Cit  Descartes 1, rue Albert Einstein
Champs sur Marne 774477 –
Marne la Vall e cedex 2
Tel: +33-1-60370246
Fax: +33-1-60376732
E-mail: info@datavideo.fr

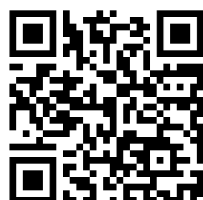

Please visit our website for latest manual update.

www.datavideo.com/product/HS-3200

datavideo
www.datavideo.com