



KRAMER ELECTRONICS LTD.

USER MANUAL

MODEL:

VIA Collage
Collaboration Hub

P/N: 2900-300403 Rev 1



VIA COLLAGE **QUICK START GUIDE**

For Installer

This guide helps you install and use your product for the first time.

For more detailed information, go to <http://bit.ly/Kramer-VIA-collaboration-hub> to download the latest manual or scan the QR code above.

STEP 1: Check What's in the Box

1. **VIA Collage** Collaboration Device
2. Power supply (19V DC) with power cords
3. Quick Start Guide
4. DP to HDMI Adapter

STEP 2: Install the VIA Collage

Place the **VIA Collage** on a table or mount in a rack with optional adapter RK-COLLAGE.

STEP 3: Inputs and Outputs at a Glance

Always switch off the power on each device before connecting it to your **VIA Collage**.

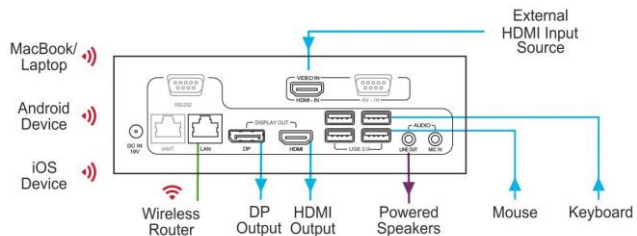

Always use Kramer high-performance cables for connecting AV equipment to the **VIA Collage**.

STEP 4: Connect the Unit

- Connect keyboard and mouse
- Connect your main display (dual displays are optional)
- Connect a Local Area Network (LAN) cable for connection to your network or use a router for connection to Wi-Fi
- Connect the power supply
- Turn on the device

STEP 5: Configure VIA Collage

Open the **VIA Collage** menu and click on Features, then on Settings.

Enter password: viaadmin.

The Settings Menu tabs are:

- LAN Settings – Configure your network parameters and apply settings
- Room Name/Code – Manage room code and name preferences
- Configurations – Activate/deactivate PiP, media mode and other options
- System Controls – Manage your display and audio settings, run control panel, etc.
- Wallpaper – Insert a custom wallpaper image
- Third Party Apps – Install/remove third party software applications
- Authentication – Activate presentation mode and define moderator/participant settings
- Streaming Server – Configure your IP streaming server address

After settings are defined, click on reboot button to apply all settings.

For more details, read the Settings section in the user manual.



VIA COLLAGE **QUICK START GUIDE**

For User

STEP 1: Connect Your Device to the Proper Network

Connect your device to the same network used by Kramer **VIA Collage** in the specific meeting room (either Wi-Fi or LAN).

STEP 2: Run or Download the Application

MAC or PC

1. Navigate to the embedded Web page of **VIA Collage** by entering the Room Name of the VIA into your computer's browser.
2. Select Mac or Windows and run the application or download the installation file by clicking on the VIA Setups tab.



Welcome to VIA Collaboration Hub,
please download the latest **VIA Application**



MAC



WINDOWS



VIA SETUPS

iOS / Android

1. Download and install the free VIA App from Apple's App Store or Google's Play Store. Use the QR code above.

STEP 3: Login



Room Name	<input type="text" value="192.168.11.67"/>
Nickname	<input type="text" value="dave"/>
Room Code	<input type="text" value="0002"/> 
<input type="button" value="Login"/>	

Room Name: Copy the room name as appears in the wallpaper (IP Address).

Nickname: Enter a name for your device.

Room Code: Enter a 4-digit code as it appears in the wallpaper.

Login: Press Login to join the meeting.

STEP 4: Main Menu



Click on Step-in™ to put your screen up front and on Participants to see who else is connected.

STEP 5: Features



Wireless Connection

Bring your own device (BYOD) and join the session through wireless connection. No dongle is needed.



MultiMedia

Share smooth full motion video (up to 1080p/60), Mp3 files, and photos.



Cloud

Drag and drop files to the cloud to share instantly with everyone in the meeting.



File Transfer

Share a file with one or several collaborators.



Whiteboard

Create, annotate, illustrate, review or highlight the current display.



Start Collaboration

Click to collaborate through a common display, using your own device. Multiple users can interact and control what's happening on the main display at the same time.



Enable Control

Give a participant control over the presenter's MAC® or PC laptops.



Chat

Send a message to a colleague in the meeting.



Web Browser

Open a browser for presenting any content directly from a website.



View Main Display

View the main screen on your own device.



Third Party Apps

Supports office applications and conferencing programs such as Skype®, WebEx®, Go To Meeting®, Lync® and more.



HDMI Input 1

Connect any external HDMI source (camera, DVD, Blu-ray™) and present it over the main screen view.



Contents

1	Introduction	1
1.1	Applications & Features	2
1.2	VIA Collage Controls and Connections	2
2	Setting Up VIA Collage	4
2.1	Connecting VIA Collage to a Display	5
2.2	Downloading and Running VIA Collage Software	6
2.3	Logging In to VIA Collage	7
3	VIA Collage Functions and What They Do	8
4	Using VIA Collage	12
4.1	VIA Collage Main Menu	12
4.2	Enabling Control	14
4.3	Chatting with Participants	15
4.4	Sharing Files	16
4.5	Accessing Cloud Data	18
4.6	Whiteboard Collaboration	18
4.7	Whiteboard Functions	19
4.8	Showing Content from a Third Party Device	23
4.9	Picture-in-Picture	23
4.10	Calling with Skype	24
4.11	Using GoToMeeting	24
4.12	Using WebEx	24
4.13	Using Microsoft Lync	25
4.14	Accessing a Web Page	25
4.15	VIA Collage Settings Menu	25
4.16	User Experience	38
5	Technical Specifications	44

Figures

Figure 1:	VIA Collage Collaboration Hub	3
Figure 2:	Connecting the VIA Collage Collaboration Hub	5
Figure 3:	VIA Collage Admin Features	8
Figure 4:	VIA Collage Main User Screen	10
Figure 5:	The Participant List	13
Figure 6:	Enable Control	15
Figure 7:	Chat Window	16
Figure 8:	Admin File Sharing	17
Figure 9:	User File Sharing	17
Figure 10:	Shared Files on the Cloud	18
Figure 11:	Whiteboard Toolbar	19
Figure 12:	Wide Desktop	20
Figure 13:	Multiple Screen	20
Figure 14:	Screen Sharing	22
Figure 15:	Showing a Third-Party Screen	23
Figure 16:	Settings Screen	26
Figure 17:	LAN Settings Screen	27
Figure 18:	Room/Name Code Screen	28

Figure 19: Configurations Screen	29
Figure 20: Authentication Screen	31
Figure 21: Moderator Mode	32
Figure 22: Login Screen When Moderator Mode is Active	33
Figure 23: Third Party Apps Screen	34
Figure 24: Setting Application Name	35
Figure 25: Wallpaper Screen	36
Figure 26: System Control Screen	37
Figure 27: Android Tablet	39
Figure 28: Samsung Galaxy	40
Figure 29: iPad	41
Figure 30: iPhone	42
Figure 31: PC	43

1 Introduction

Welcome to **VIA Collage**!

VIA Collage is Kramer's unique, powerful wireless presentation and collaboration hub. It converts any display at any location into an interactive meeting point, and it works with a wide range of presentation devices from desktop and notebook computers to tablets and smartphones.

Each participant in a **VIA Collage** session can quickly view, edit, annotate, comment, and share content with other participants. Participants can share their ideas through the primary screen, or break off with others into smaller groups during a meeting.

The **VIA Collage** integrates seamlessly with any organization's current IT infrastructure, converting any projector or screen into a networked device that users can share and view on their current devices. Every local connection to **VIA Collage** is wireless, free of dongles, cables, and other compatibility peripherals.

Key features of **VIA Collage**:

- Login using conventional Wi-Fi or LAN connections, no dongle needed
- Provides true HD 1080p/60 video streaming
- Supports Windows laptops and MAC®, as well as iOS and Android mobile operating systems
- Compatible with all common Web browsers
- Up to 255 users can be logged in simultaneously
- Up to 12 participant screens can be displayed simultaneously on dual screens (six on each screen).
- Supports popular third-party conferencing programs
- Touchscreen compatible with whiteboard and full annotation controls

1.1 Applications & Features

Present, share, chat, send and receive files, hold sidebar conversations, annotate, edit, and save copies of all your work, just as you would with a whiteboard or flip chart...except that you can do it all from your notebook computer, tablet, and smartphone.

Here are just a few of the things you can do with **VIA Collage**:

Up to six different participant screens can be shown at the same time. **VIA Collage** automatically sizes each screen to the maximum available resolution, displaying tiles for two or more screens. Finished sharing? Tap Step-out to disconnect.

Chat and Share a file: Need to ask a meeting participant a question? Click on their screen name and send them a text message with complete privacy. Windows and Mac PC users can also share files between themselves or the main presenter, all at the click of a mouse.

Control a participant's computer: Need to access files or play back a presentation from a participant's PC? Simply click Enable Control on the PC, and its cursor can be controlled remotely to launch programs and play media.

Multimedia: Sometimes it's just easier to explain your ideas with a video. Simply click the Multimedia tab on your device's screen and you can load and display JPEG images (all operating systems) and play MP4 videos (Windows and Mac PCs and iOS devices only). You can also display and share PDFs from any logged-in device.

1.2 VIA Collage Controls and Connections

This section defines **VIA Collage**.

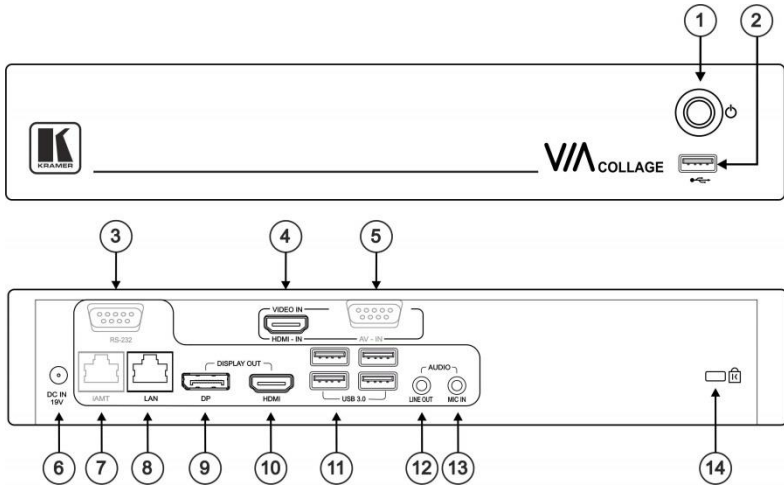

Figure 1: VIA Collage Collaboration Hub

#	Feature	Function
1	Power Button	For turning the machine on and off
2	USB Connector	For upgrading firmware or connecting a USB device
3	RS-232 Connector	Not in use
4	VIDEO IN HDMI-IN Connector	Connects to an HDMI source
5	AV – IN RS-232 Connector	Not in use
6	DC IN 19V Connector	Connects to the 19V DC power supply
7	iAMT RJ-45 Connector	Not in use
8	LAN RJ-45 Connector	Connects to a wireless router
9	DISPLAY OUT DP Connector	Connects to a DisplayPort display
10	DISPLAY OUT HDMI Connector	Connects to an HDMI display
11	USB 3.0 Connectors	Connect to up to four USB devices
12	AUDIO LINE OUT 3.5mm Mini Jack	Connects to an unbalanced stereo audio acceptor
13	MIC IN 3.5mm Mini Jack	Connects to a microphone
14	Lock Opening	Connects to a security locking cable

2 Setting Up VIA Collage



Always switch off the power to each device before connecting it to your **VIA Collage**. After connecting **VIA Collage**, connect its power and then switch on the power to each device.

To connect the **VIA Collage** as illustrated in the example in [Figure 2](#) you need:

- A **VIA Collage** Wireless Collaboration Hub
- A display (projector, monitor, or screen). NOTE: A touchscreen display is best for annotation
- A Local Area Network (LAN) cable for connection to your network. For wireless network connectivity, use a commercial wireless router

The following client devices can be used with Kramer's **VIA** collaboration hub:

- A Windows 7/8® (32-bit/64-bit) computer
- A Macintosh® computer, using OSX 10.6.5 or newer (version 10.6.8 recommended)
- An iPad/iPhone® tablet/smartphone with the **VIA Collage** app installed (iPad 2 or later, iOS 5 or later, iOS 6.0 recommended)
- An Android® OS 3.2 tablet/smartphone with the **VIA Collage** app installed

These optional add-ons can enhance your **VIA Collage** system:

- A USB or HDMI camera for distant participants connecting through Lync®, Skype®, GoToMeeting®, or WebEx®
- A conferencing speakerphone for remote communication as well as audio playback of content being shared on the display
- A Kramer **SID-X3N** 4-input multi-format video-over-HDMI transmitter & step-in commander can also be used to expand the number of local video sources through the **VIA Collage** HDMI input.

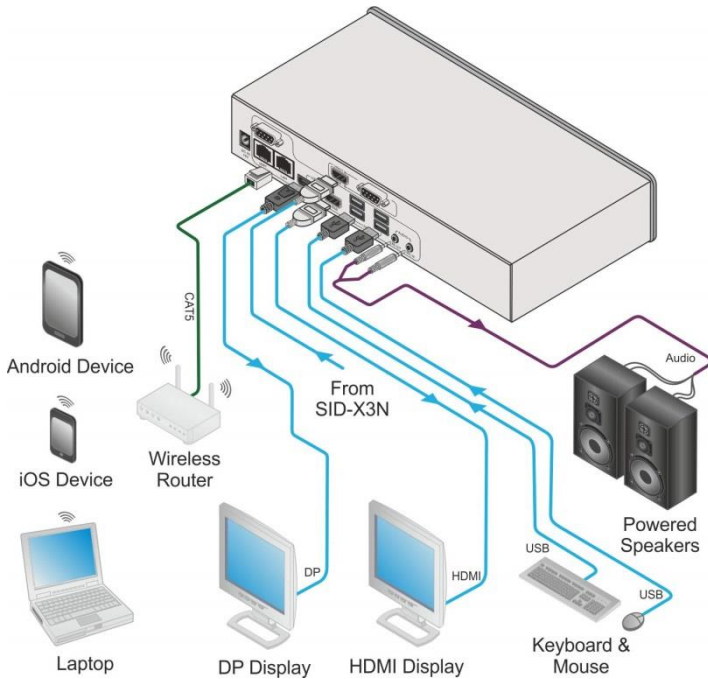

Figure 2: Connecting the **VIA Collage** Collaboration Hub

2.1 Connecting VIA Collage to a Display

VIA Collage is equipped with dual display output connections.

- The HDMI connection can be used with any compatible projection or direct-view display, such as an LCD monitor. This connection carries embedded audio, and can also be routed and switched just like any other HDMI connection
- The DisplayPort connection can be used with compatible projection or direct-view displays. Unlike the HDMI port, the DisplayPort jack does not carry embedded audio and requires a separate audio connection

VIA Collage's internal video card reads the Extended Display Identification Data (EDID) for any connected display and sets the optimum display resolution and image refresh rate automatically through the HDMI and DisplayPort jacks.

For full functionality, **VIA Collage** must be connected to a local area network (LAN). You must assign an IP address to the **VIA Collage**.

NOTE: To allow participation in a collaborative session (send and receive content), connect the **VIA Collage** hub and all participant devices (PCs/ MACs/ smartphones/tablets) to the same network (LAN - wired/wireless).

The **VIA Collage** hub receives user's display/screen information and multimedia files from their device (laptop/tablet/smartphone) and sends them to the collaboration display (the display connected directly to **VIA Collage** hub unit).

2.2 Downloading and Running VIA Collage Software

All participants in a meeting must download and run either the Kramer **VIA** executable file (PC, Mac) or the appropriate Android/iOS app.

To access the PC and Mac executable files:

- Open your Web browser and enter the IP address for your **VIA Collage** unit
- Click on the file format (Win7/8, Mac OS) for your computer. You are prompted to save this file to your computer. Select "OK" and download.
- Once downloaded, locate the file on your computer (under "Downloads") and click to launch it. You then see the **VIA Collage** login screen. (For faster access, move the file to your desktop)

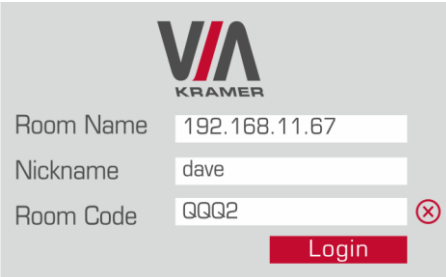

VIA
KRAMER

Room Name

Nickname

Room Code ⊗

Login

- For tablets and smartphones, the Kramer **VIA** app is found in the App Store (iOS) and Google Play (Android). Download the app to your tablet/phone and install. When you run the app, you see the following screen:



Room Name

Nick Name

Room Code

2.3 Logging In to VIA Collage

Windows and Mac OS

- Choose a username (nickname) for your device (it can be any mix of letters and numbers) then enter it on the login screen
- Next, enter the room code, seen on the lower right part of the screen. This lets you access **VIA Collage**

iOS and Android

- First, enter the IP address for the **VIA Collage**. This is found on the main display screen in the lower left
- Next, choose a username (nickname) for your device (it can be any mix of letters and numbers) then enter it on the login screen of your device
- Finally, enter the room code as seen on the lower right part of the screen. This lets you access **VIA Collage**. Now, you're ready to go!

3 VIA Collage Functions and What They Do

VIA Collage presents two types of screens depending whether it is being used by the Admin or by a User. The following screen shots illustrate both types.

The illustration below shows the VIA Collage main Admin screen and its functions:

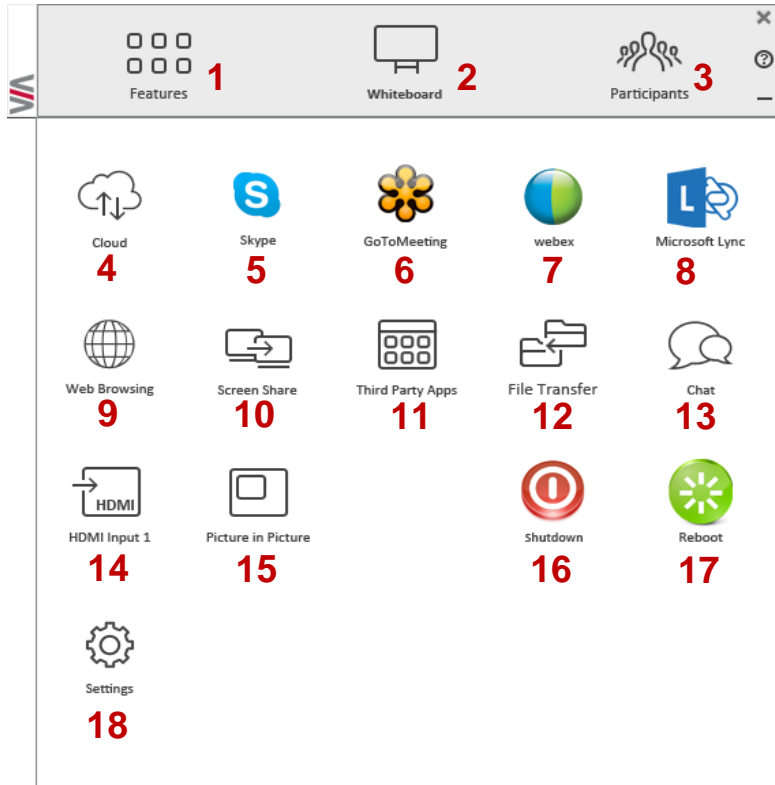

Figure 3: VIA Collage Admin Features

Item	Icon	Action
1	Features	Allows user to see and access all available features of VIA Collage
2	Whiteboard	Opens a canvas to annotate, draw, and update document collaboratively over a live stream
3	Participants	Provides a list of all participants in the session
4	Cloud	Drag and drop files to the cloud to share instantly with everyone in the session
5	Skype	Starts Skype video conferencing tool
6	Go to Meeting	Starts a GoToMeeting session
7	WebEx	Starts a WebEx session
8	Microsoft Lync	Opens Lync client for audio and video conferencing
9	Web Browser	Opens the browser at the VIA Collage gateway to present any content directly from the Web site
10	View Main Screen	Shows a mirror of the VIA Collage collaboration display on the user's devices (laptop, iPad, MacBook, Android tablet). The user can see all the activities of the VIA Collage collaboration display on his system (this feature is called "Screen Share" in the Admin menu)
11	Third Party Apps	Shows third-party applications installed and integrated with VIA Collage
12	File Transfer	Shares files between the available participants during the session
13	Chat	Allows sending chat messages among available participants during that session
14	HDMI Input 1	Displays/hides external video source connected to the VIA Collage .
15	Picture in Picture	Switches the external video source (HDMI input) between PIP (Picture-in-Picture) mode and full screen mode
16	Shut Down	Shuts down the VIA Collage system
17	Reboot	Reboots the VIA Collage System
18	Settings	Performs settings on the LAN, configurations related to room code, room name third-party apps, system controls, wallpaper streaming configuration and activation center

The illustration below shows the **VIA Collage** main User screen and its functions:

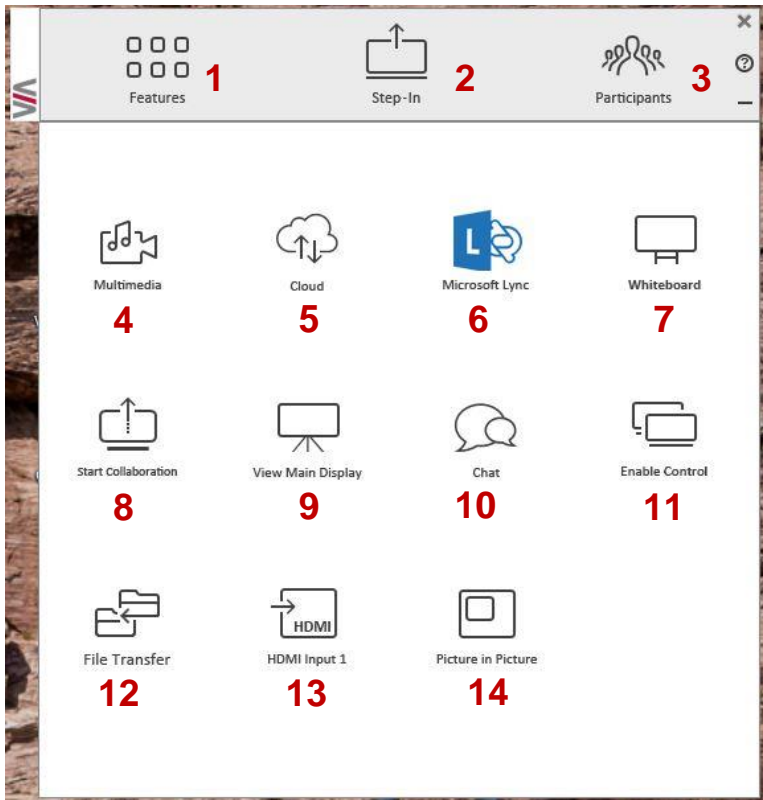

Figure 4: **VIA Collage** Main User Screen

Item	Icon	Action
1	Features	Allows user to see and access all available features of VIA Collage
2	Step-In/ Step-Out	Allows the user to show his device's screen on main display, or to step out
3	Participants	Provides a list of all participants in the session
4	Multimedia	Supports video formats: avi, vob, mp4, mov, mpx (ex. mpg). Shares smooth full-motion video (up to 1080p/60), MP3 files and photos
5	Cloud	Drag and drop files to the cloud to share instantly with everyone in the session
6	Microsoft Lync	Opens Lync client for audio and video conferencing
7	Whiteboard	Opens a canvas to annotate, draw, and update document collaboratively over a live stream
8	Start Collaboration	Click to collaborate through a common display using your own device. Multiple users can interact and control the main display at the same time
9	View Main Screen	Shows a mirror of the VIA Collage collaboration display on the user's devices (laptop, iPad, MacBook, Android tablet). The user can see all the activities of the VIA Collage collaboration display on his system (this feature is called "Screen Share" in the Admin menu)
10	Chat	Allows sending chat messages among available participants during that session
11	Enable Control	Gives participants control over the presenters Mac or PC laptop
12	File Transfer	Shares files between the available participants during the session
13	HDMI Input 1	Displays/hides external video source connected to the VIA Collage .
14	Picture in Picture	Switches the external video source (HDMI input) between PIP (Picture-in-Picture) mode and full screen mode

4 Using VIA Collage

VIA Collage is a powerful and versatile collaboration hub that gives participants a wide selection of presentation tools. In this section, we'll look at each of those tools and discuss briefly how it works.

4.1 VIA Collage Main Menu

This section refers to the user's experience.

The **VIA Collage** User main menu has three tabs across the top – Features, Step-In/Out, and Participants.

- Clicking on the Features tab on the main menu allows the user to see and access all available functions of **VIA Collage**
- Clicking on the Step-In tab on the main menu displays your PC/device screen on the main screen. Clicking Step-Out removes your device screen from the main screen
- Clicking on the Participant List tab reveals a list of all participants in the session

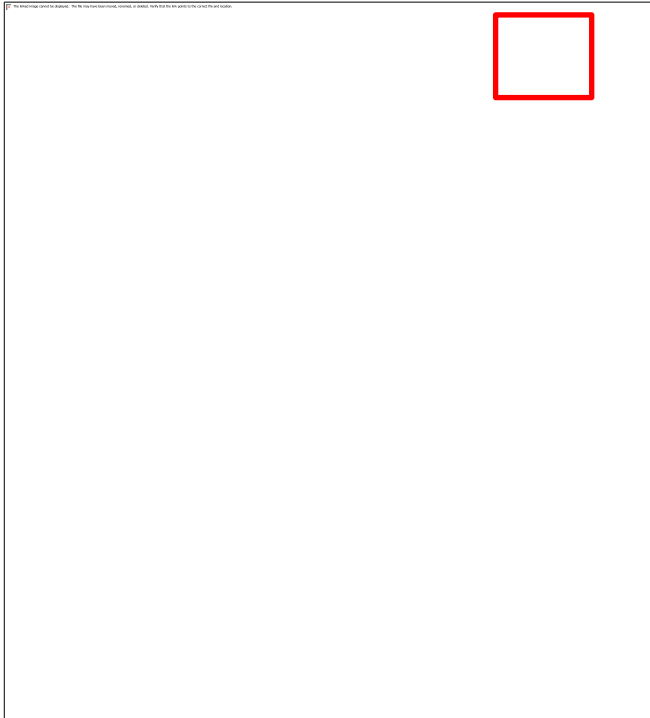









Figure 5: The Participant List

Under Participants, the following icons are used:

Item	Icon	Meaning
Display Status		Start a presentation at a display
		The user is currently presenting
Chat Status		Start a chat session with any available participants
		The participant is currently chatting with you. Click to open the chat session

Item	Icon	Meaning
File Transfer		Start a file transfer with another participant
		File transfer is already active with that participant
Enable Control		Take control of any user while the user is displaying
		Admin has the control of that user

4.2 Enabling Control

This function allows the admin to take control of a participant's PC (Windows or Mac OS). (In our example, [Figure 6](#), user *Dave* has stepped in and the Admin has taken control of *Dave*):

The admin can work on *Dave*'s system as he has taken control. (Admin can play media or work on a document or presentation file collaboratively with *Dave*).

Any other participant who wants to take control or collaborate with *Dave*'s system can click on the Start Collaboration icon and drag his laptop mouse to the top and off their local screen. That cursor now moves to the **VIA Collage** unit and appears on the main display of *Dave*. Buttons are shown in the picture below:

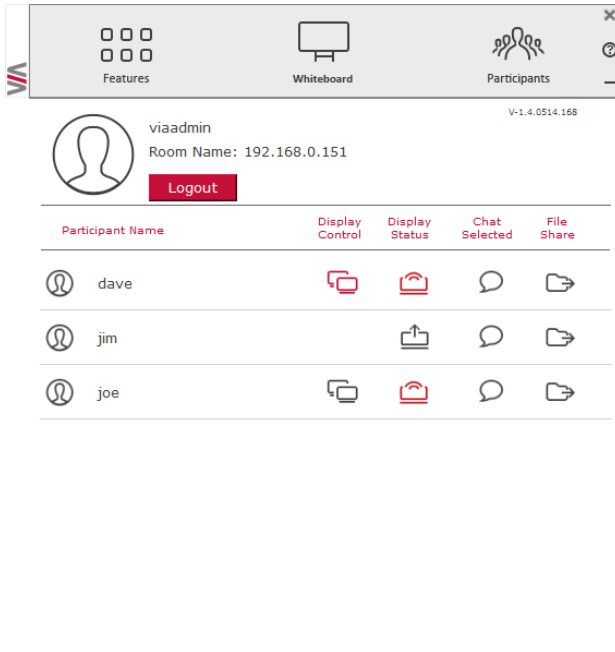



Figure 6: Enable Control

4.3 Chatting with Participants

The admin or user can start a chat session to exchange text messages between users.

To initiate a chat session:

- Go to the participant list and click the chat icon  for the desired participant. The chat window opens and you can chat with selected participant:

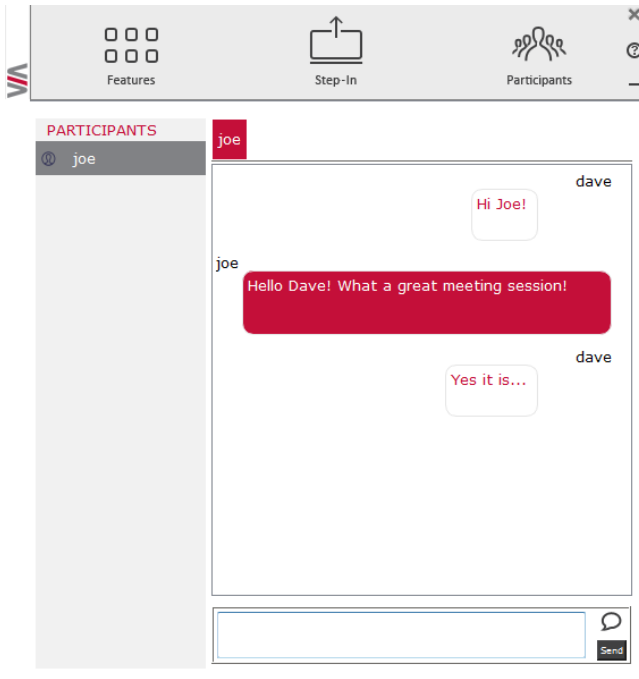

Figure 7: Chat Window

In the chat window, the participant's name is at the left side of the window and your chat messages are on the right side.

The user can check for active chat sessions by going to *Features > Chat*



4.4 Sharing Files

VIA Collage can transfer files between PC/Mac logged in users.

To share a file:

- Go to the participant list and click on the file share icon  for the desired participant with whom you wish to share a file.

- In the cloud directory, select the desired file on your device. Then, click Share 

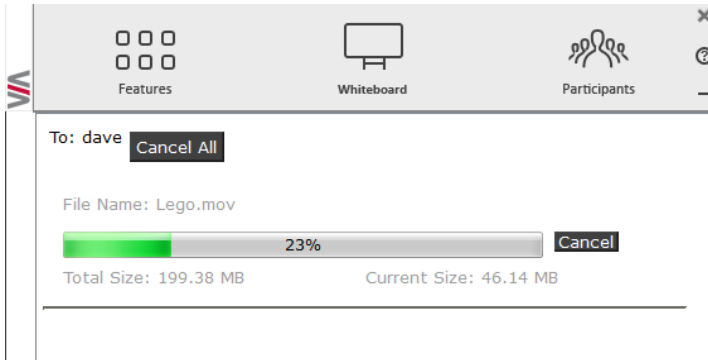

Figure 8: Admin File Sharing

The target participant needs to select a location to save the file and start the file transfer process. Once completed, the file is saved on that participant's system.

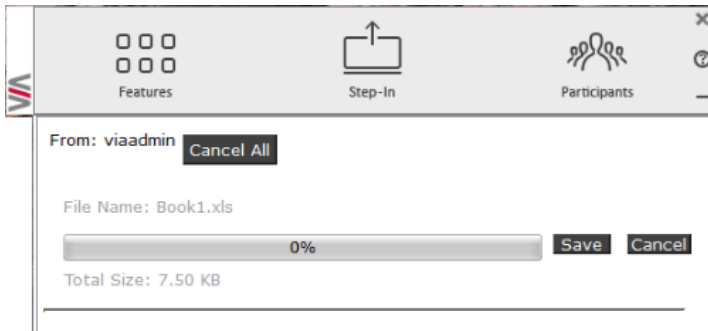

Figure 9: User File Sharing

When completed, the file is saved at receiver's system.

You can check or cancel currently sharing file from *Features > File Transfer*.



4.5 Accessing Cloud Data

The cloud is used to access all data that has been shared by participants using **VIA Collage** hub.

To access cloud data:

- Click on *Features* and then click on the cloud icon  to go to the Cloud directory where all the users' shared files were saved.

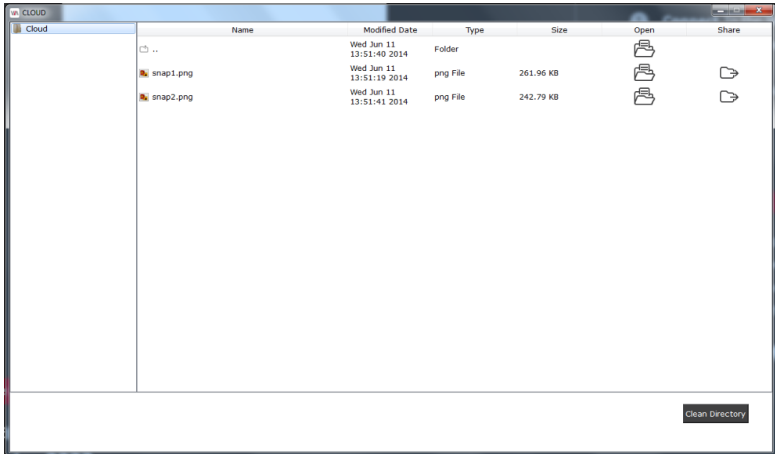

Figure 10: Shared Files on the Cloud

- To delete all files from the cloud directory, click on **Clean Directory**
- A warning note appears that this is a permanent delete action

4.6 Whiteboard Collaboration

The whiteboard function creates a canvas on the **VIA Collage** hub. With whiteboard, you can:

- Access a wide range of drawing and annotating tools
- Comment on any content shown on screen
- Insert any kind of images
- Annotate on an extended desktop

To open the Whiteboard:

- Go to the main menu and click on the Whiteboard icon. This starts a whiteboard session on **VIA Collage**.

4.7 Whiteboard Functions

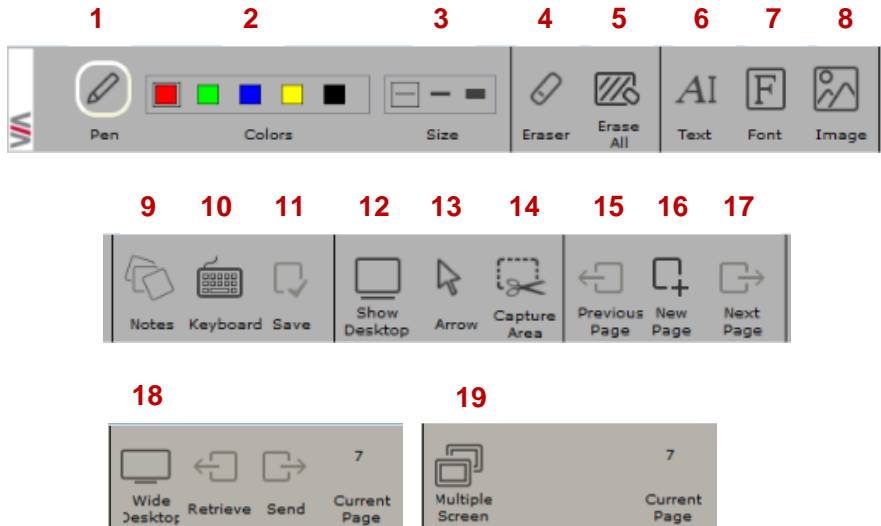

Figure 11: Whiteboard Toolbar

Item	Icon	Action
1	Pen	Enables drawing on the whiteboard
2	Color	Changes the color of the line with various available colors
3	Size	Chooses the line thickness
4	Eraser	Erases your annotations
5	Erase All	Cleans the page
6	Text	Inserts text on your whiteboard page
7	Font	Changes the text font of your whiteboard page
8	Image	Inserts an image at your whiteboard page
9	Notes	Creates comments or remarks about your annotation on your whiteboard page
10	Keyboard	Opens a virtual keyboard to insert text on your whiteboard
11	Save	Saves all your activities either as PDF or as JPEG format
12	Show Desktop	Displays your desktop with all running applications. The user can also annotate at the running application using the desktop stylus

Item	Icon	Action
13	Arrow	Selects any object or image
14	Capture Area Tool	The mouse pointer turns into a plus sign. Click the upper left corner of the area you want to capture and drag along the screen to the limit of the capture. The selected area is displayed in gray. The area is then included in the current or new page as an object
15	Previous page	Moves to previous page (when multiple pages added)
16	New page	Creates a new page or to add a new page
17	Next page	Moves to next page (when multiple pages added)
18	Wide Desktop	This icon appears on the whiteboard when two displays are connected to VIA Collage . Using this function, you can send pages from screen 1 to screen 2 and retrieve pages from screen 2 to screen 1. When a participant sends any page to screen 2 and then annotates it on the main VIA Collage screen, those annotations show simultaneously on screen 2. (see Figure 12)
19	Multiple screen	Available when a dual display is connected to VIA Collage . One display can be used for collaboration on the whiteboard and the second can share content from the users. In multiple screens the user can draw on screen 1 and can send this page to screen 2 to show to the audience. (see Figure 13)

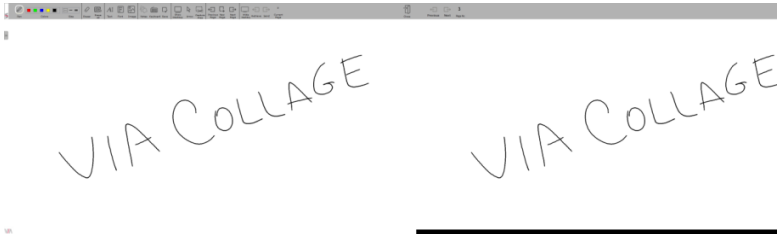

Figure 12: Wide Desktop

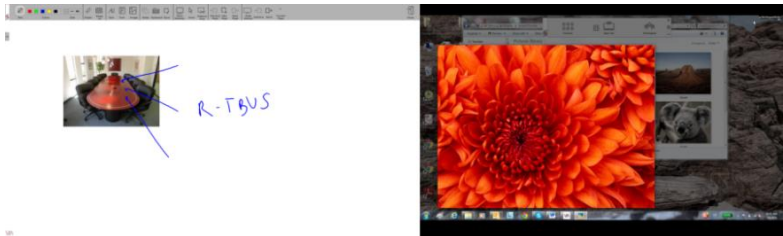











Figure 13: Multiple Screen

4.7.1 Show Desktop



Show Desktop allows you to hide the whiteboard and to navigate freely on your desktop. A toolbar is available for making annotations on your desktop and capturing an object. For example, capture an area of the screen and add it as an object in your current page.

Icon	Name	Action
	Whiteboard	Press this button to immediately return to your board page
	Pencil	Writes on the whiteboard
	Eraser	Erases precisely what you have written on the whiteboard
	Selection Tool	Selects any object to move it and apply changes
	Capture Area Tool	The mouse pointer turns into plus sign. Click and drag over the desired area
	Window selection	Directly captures a window and all of its content.
	Notes	Adds remarks or comments about the added annotation at the whiteboard
	Virtual Keyboard	Inserts text on the whiteboard
	Save	Saves your activity in either .jpg or .pdf format
	Exit	Exits the whiteboard

4.7.2 Screen Share

Screen Share allows the admin to share his screen with all available users so that the user can see all the activities of the gateway running at their local system only.

To use Screen Share:

- Click on features and then click on Screen Share  Screen Share
- The user sees the collaboration display screen at their system and a check mark is shown on the Screen Share button  Screen Share

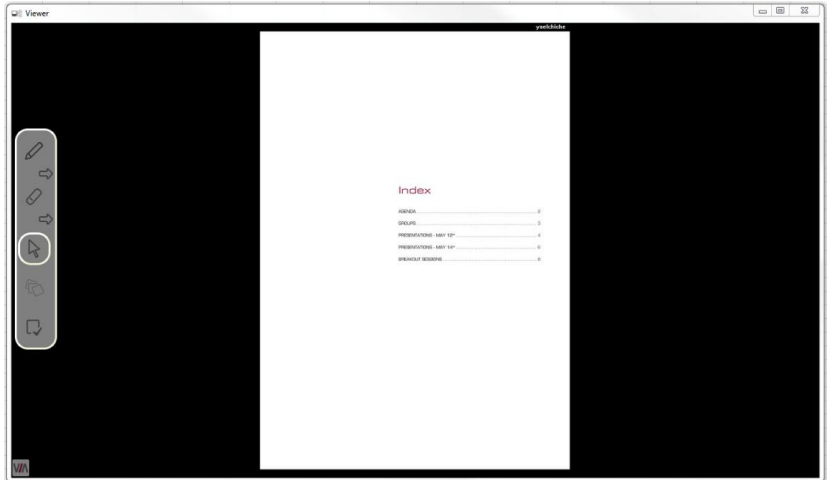
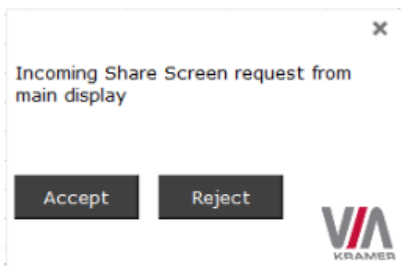

Figure 14: Screen Sharing

Notes: The user is asked to accept to view the shared screen, as shown below.



- To view the main collaboration display on the user's system, the user needs to stop both his display and media.

4.8 Showing Content from a Third Party Device

VIA Collage gives you the flexibility to show content from any connected third-party device such as a media player, Apple TV, Roku, video cameras with composite video or HDMI outputs, and Samsung's AllShare Play wireless hub, along with your display. You can connect an extra device to **VIA Collage** using the HDMI input, or add an external HDMI switcher to select from multiple third-party devices.

To use this feature:

- Click on Features, then click on Show/Hide output of HDMI Input 1

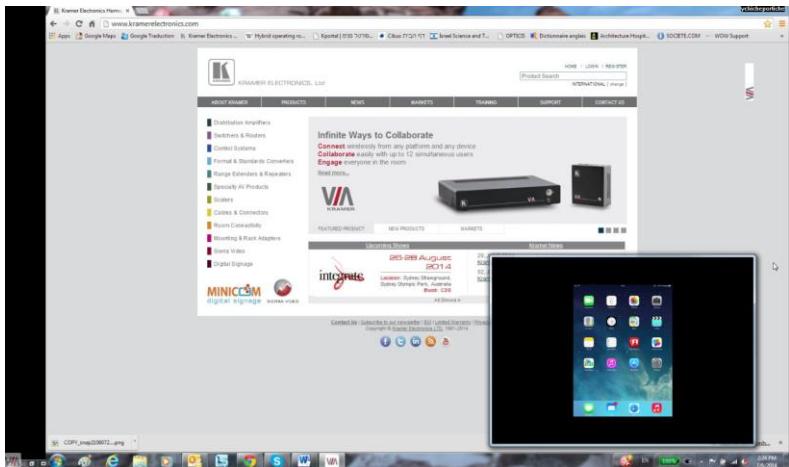

Figure 15: Showing a Third-Party Screen

4.9 Picture-in-Picture

The **VIA Collage** Picture-in-Picture feature lets you toggle between full-screen mode and PIP mode for HDMI Input 1.

To use PiP:

- Click on Features, and then click on Picture-in-Picture

This toggles the HDMI Input 1 video signal mode between PIP and Full Screen.



If the message shown below appears when HDMI Input is selected, it means that there is no device connected to **VIA Collage's** HDMI input, or a connected device is not turned on. Report this condition to the admin.

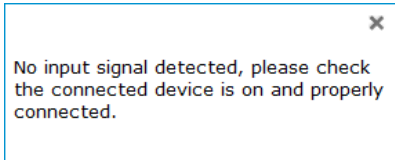

4.10 Calling with Skype

VIA Collage lets you call using Skype to any other Skype user in the world.

To activate Skype:

- Click on Features and click on



This launches Skype and you can login and call/chat with any available contact

4.11 Using GoToMeeting

GoToMeeting is integrated with **VIA Collage**, providing you with a simple and powerful way to hold unlimited online meetings. A **VIA Collage** admin can start a meeting and share his screen with any available user, anywhere in the world.

To launch GoToMeeting,

- Click on Features and click on



This takes you to the GoToMeeting website (<http://www.gotomeeting.com/fec/>) where you can download the executable file and start an online meeting

4.12 Using WebEx

WebEx is a conferencing program which lets you and others meet online and share files, information, and expertise. WebEx is integrated with **VIA Collage**.

To activate a WebEx online meeting:

- Click on Features and click on the WebEx icon



This links to the WebEx Web site

(<http://www.webex.com/>) from which you can download the app and start online meetings.

4.13 Using Microsoft Lync

Microsoft Lync provides instant messaging, voice over IP and video conferencing.

To start video conferencing with Microsoft Lync:

- Click on Features and click on  Microsoft Lync

This opens the Microsoft Lync sign-in page. The user can login and start messaging or video conferencing.

4.14 Accessing a Web Page

VIA Collage can directly launch a Web browser. You do not need to exit **VIA Collage** to open a Web site, or launch a Web-based presentation.

To open the Web browser:

- Click on Features and click on the Web Browsing icon 

This opens the default browser (Internet Explorer) through **VIA Collage** and you can navigate to any Web site or online video/presentation file.

4.15 VIA Collage Settings Menu

The Settings menu is where you configure your **VIA Collage** unit and manage third party applications.

The Settings menu tabs include:

- LAN Settings – configures network parameters
- Room Name/Room Code – manages room code and name preferences
- Configurations – activates/deactivates PIP and media mode, etc.

- System Controls – manages your display and audio settings, run control panel, etc.
- Wallpaper – inserts a customized wallpaper
- Third Party Apps – installs/removes third-party software applications
- Authentication – activates presentation mode and define moderator/participants settings
- Streaming Server– configures your IP streaming server address

To open the settings page use keyboard and mouse connected to **VIA Collage** unit:

- Click on Features to expand
- Click on Settings. It requests the password for the **VIA** Admin user
- Enter the password “viaadmin”

The Settings screen opens:



Figure 16: Settings Screen

- After settings are defined, click on the Reboot tab to apply all.

4.15.1 LAN Settings

Use LAN settings to change the IP address, DNS and default gateway of **VIA Collage**.



When changing these settings, make sure they are correct. Incorrect values can cause a loss of communication.

To change the IP address:

- Click on LAN Settings
- Enter as required the IP address, subnet mask, default gateway, DNS server 1, DNS server 2

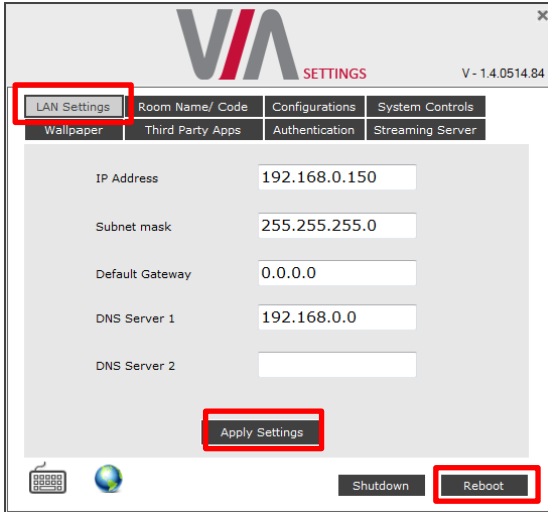

Figure 17: LAN Settings Screen

- When finished, click on Apply Settings
- Click OK at the Confirmation Message
- Click on Reboot to restart the system with the new settings

4.15.2 Room Name/Code Settings

To activate/deactivate Room Code, Date & Time:



Figure 18: Room/Name Code Screen

- **Show Room Name on Wallpaper:** This feature displays the Room Name (a standard IP address) on the **VIA Collage** home screen. By default, it displays the current IP address, but you can change it to a Domain Name System (DNS) name if local DNS services are supported by the network. To change the Room Name, enter the new address or DNS name, then click on Apply and reboot **VIA Collage**. To login any device to the **VIA Collage** client, you must enter the same Room Name in the location field on your device
- **Activate Room Code:** The Room Code is a security overlay feature that generates and updates a four digit code. It appears on the lower right of the **VIA Collage** home page. When activated, this code must be entered by any device before logging into **VIA Collage**
- **Always show on Wallpaper:** If the room code is activated, it always shows on the wallpaper below the room name, otherwise the room code only shows when logging into any client

- **Show Date Time on Wallpaper:** Displays the date/time on the top right of the display
- **Show Room Name / Code on second Display also:** Supported only if there is a second display connected to the **VIA Collage** unit. This feature allows you to show the Room Name on the wallpaper of the second display connected



The color of the text of the room name, the room code, the date and time to show on the background of the **VIA Collage** wallpaper can also be changed in this Settings menu.

4.15.3 Configuration Settings

Configuration settings allow the user to change the cloud data path to save cloud data at any desired location. It is also where the user can activate PIP mode or Media mode.

To change configurations:

- Click on Configurations



Figure 19: Configurations Screen

- **Activate PIP Mode** – Shows the output of the third party device (SID-X3N, Apple TV, Media Player, etc) as a PIP on **VIA Collage**. Otherwise, the output of a third party device is shown as a full screen image
- **Reset PIP Position** – Resets the default PIP position if the size or position of the default PIP window was changed
- **Activate Media Mode** – If multiple displays are connected to **VIA Collage**, the first display is reserved as the media screen. Multimedia files play only on the first display and the presentation shows on the second display
- **Activate System Log** – Activates the logging of all system activity either by the client or the gateway to aid diagnosing a problem with **VIA Collage**
- **Enable Quick Client Access** – Enables a floating icon on the desktop of the **VIA Collage** gateway to open the **VIA Collage** menu. The user can click on this icon and the menu opens
- **Collaboration Data Directory Path** – Sets the path where all data is saved that has been shared over the cloud by other users. The user can attach USB storage to **VIA Collage**, can change the directory path as needed, or point to a network location

4.15.4 Authentication Settings

In this section, you can activate Presentation (moderator–participant) Mode. In this mode, a participant requires permission from the moderator to use the Step-In function on **VIA Collage**.

To enable Presentation Mode:

- Click on Authentication
- Select Activate Presentation Mode and reboot **VIA Collage** gateway

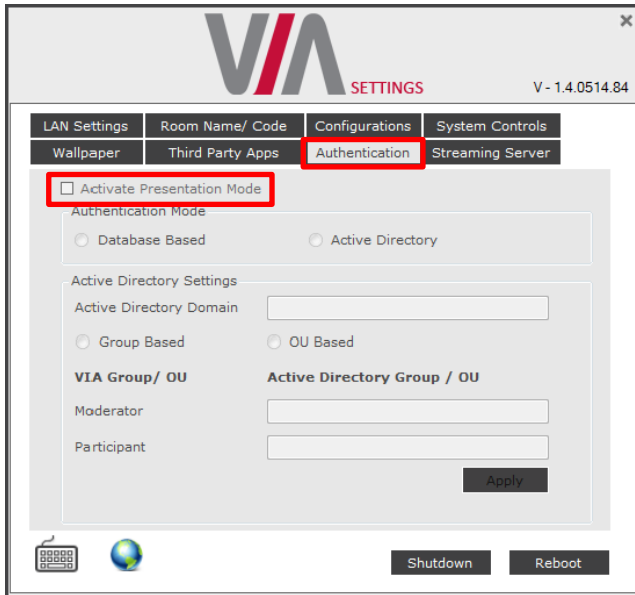

Figure 20: Authentication Screen

There are 2 default users available to login into **VIA Collage** client in Presentation mode.

Moderator:

- Default user name: su
Default password: supass

Participant:

- Default user name: user
Default password: userpass

You can create more users as needed.

To create users:

- Open the **VIA Collage** Web site by entering the **VIA Collage** IP address in any Web browser

- At the top, login with default moderator username (supass). The moderator can create a database of participants by assigning a Username, Password and Role (Moderator or Participant) to each one of them, as shown in [Figure 21](#) below

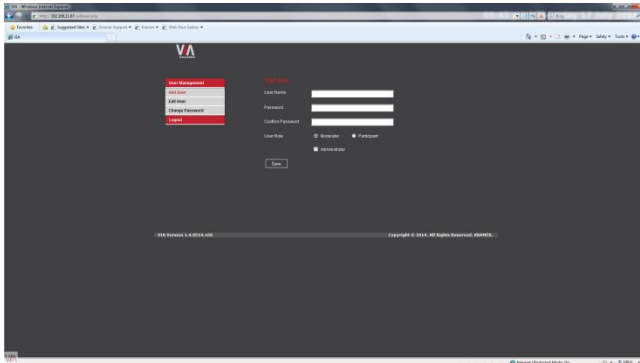

Figure 21: Moderator Mode

Now any user who was created by the moderator can get permission to join the session.

To login into the **VIA Collage** client when Presentation Mode is activated:

- Open the **VIA Collage** client and enter the location (IP address of the **VIA Collage** gateway)
- Enter user name and password (as defined by moderator)
Now you see the Room Code field.
- Enter the room code (if Room Code is activated)
- Click on Login

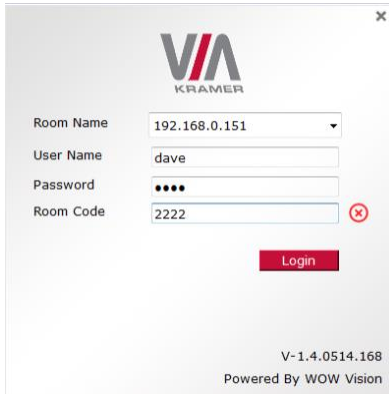

Figure 22: Login Screen When Moderator Mode is Active

To start a presentation:

- Click on “Step-In” and **VIA Collage** sends a request to the moderator for display permission

user is requesting for display

- The moderator clicks on “Allow” to start the participant’s presentation on the collaboration display

The presentation is now visible on the **VIA Collage** main display

Note: The moderator can “Step-In” at any time without permission.

4.15.5 Third Party App Settings

The Third Party App feature allows the user to add a shortcut to any third party applications already installed on **VIA Collage**. The user can then launch these applications without exiting **VIA Collage**.

The administrator can also install any other third party application that is not available on the system that a user wants to run.

To add a third party application shortcut:

- Click on Third Party Apps
- Click on Add Application Exe File
- Browse to the executable of the application that you want to add as a shortcut, for example go to: C:\Program Files (x86)\Kingsoft\Kingsoft Office\office6 and select wpp.exe to add the shortcut of Word of Kingsoft Office
- Click on Reboot

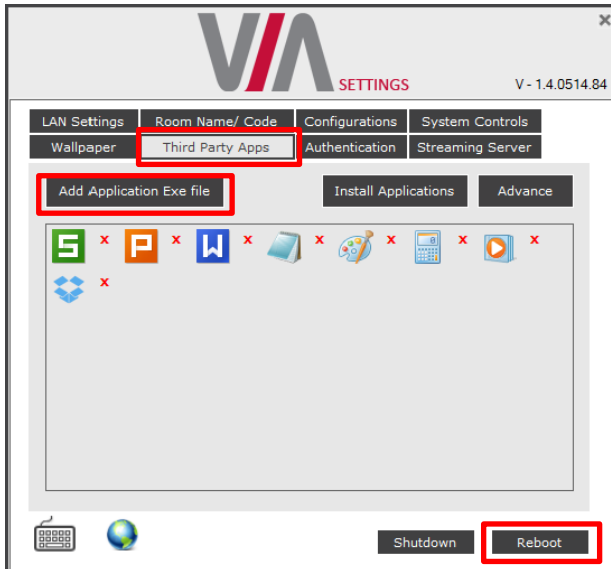

Figure 23: Third Party Apps Screen

The user can also change the icon image and name of the added third party application.

To change the icon image and name of application:

- Click on Advance
- The Set Application Name and Icons page opens
- Click on “Click here” to browse and change the icon image

- Change the application name from “Application Name” field

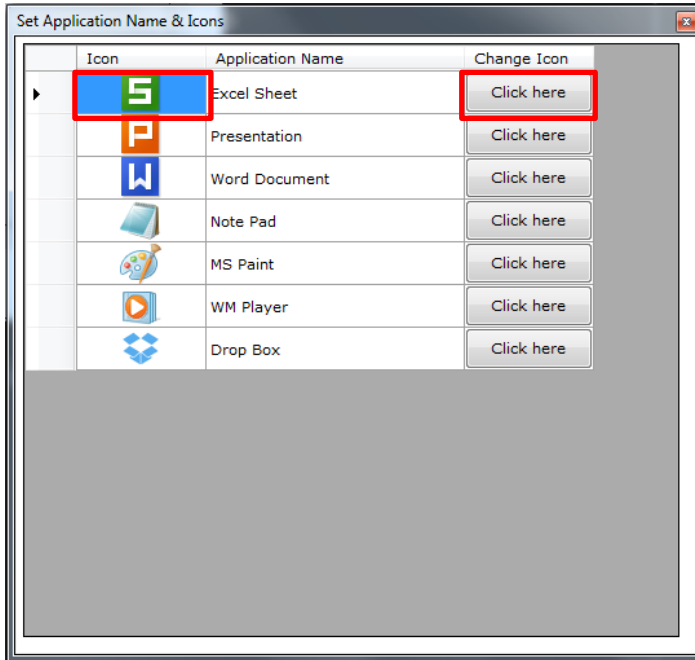
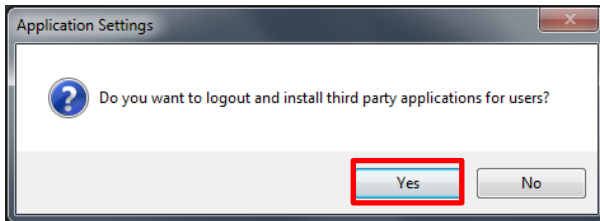

Figure 24: Setting Application Name

- Close this page and the settings page as well.
- Reboot the **VIA Collage** hub

To Install a Third Party Application:

- Click on Install Applications
- When asked to logout as a **VIA Collage** user, click Yes



- Login again as an administrator and now you can install any application. The default password is “viaadmin”.

Now download any application on your system and install it on the unit. Reboot the system after installation and add the application shortcut under third party apps for future use as explained above.

4.15.6 Wallpaper Settings

This feature allows any corporation or institution to change the default screen to match their branding and in-room equipment usage instructions.

To change the wallpaper:

- Click on Wallpaper
- Click on Upload Wallpaper
- Select Wallpaper (must be an image file – jpeg, png, bmp) from your system
- Click on Reboot

The background image on **VIA Collage** changes after rebooting



Figure 25: Wallpaper Screen

4.15.7 Streaming Settings

This feature is currently unavailable.

4.15.8 System Control Settings

System controls access the control panel, audio settings, display settings, task manager, system health and log files of the **VIA Collage** unit. The log folder is only available if system logging is activated from the configurations tab of settings.



Figure 26: System Control Screen

The **VIA Collage** unit is pre-activated by Kramer.

4.16 User Experience

VIA Collage enables a high level of collaboration in meetings. Participants can share files, chat, edit a common document, or stream full HD (1080p/60) video content. Following is a summary of **VIA Collage** functions:



Wireless Connection

Bring your own device (BYOD) and join the session through wireless connection. No dongle is needed.



Enable Control

Give a participant control over the presenter's MAC® or PC laptops.



MultiMedia

Share smooth full motion video (up to 1080p/60), Mp3 files, and photos.



Chat

Send a message to a colleague in the meeting.



Cloud

Drag and drop files to the cloud to share instantly with everyone in the meeting.



Web Browser

Open a browser for presenting any content directly from a website.



File Transfer

Share a file with one or several collaborators.



View Main Display

View the main screen on your own device.



Whiteboard

Create, annotate, illustrate, review or highlight the current display.



Third Party Apps

Supports office applications and conferencing programs such as Skype®, WebEx®, Go To Meeting®, Lync® and more.



Start Collaboration

Click to collaborate through a common display, using your own device. Multiple users can interact and control what's happening on the main display at the same time.



HDMI Input 1

Connect any external HDMI source (camera, DVD, Blu-ray™) and present it over the main screen view.

Note: Different devices enable different features depending on the device capabilities. See the following illustrations.



Figure 27: Android Tablet

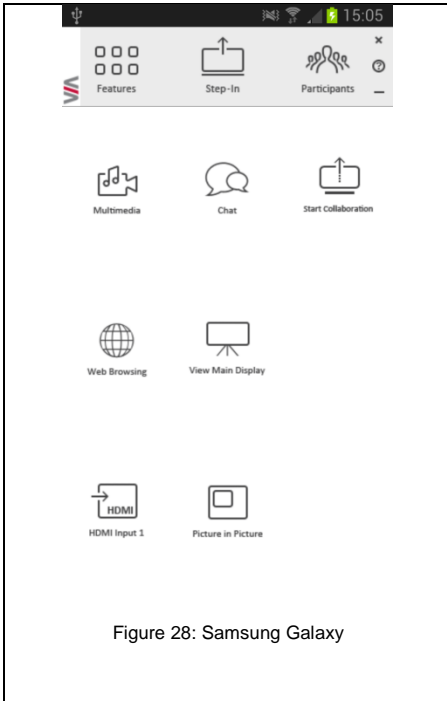
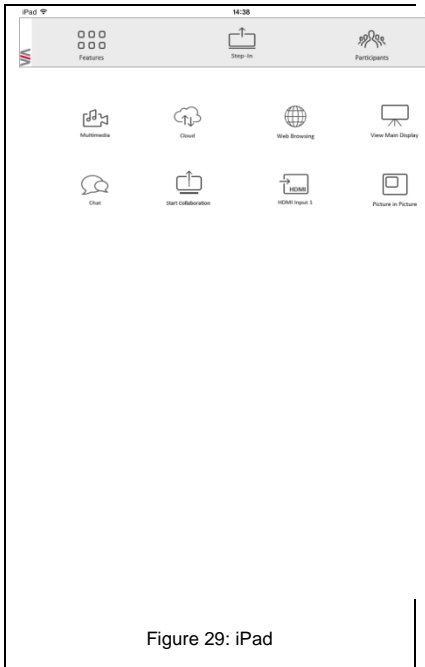

Figure 28: Samsung Galaxy



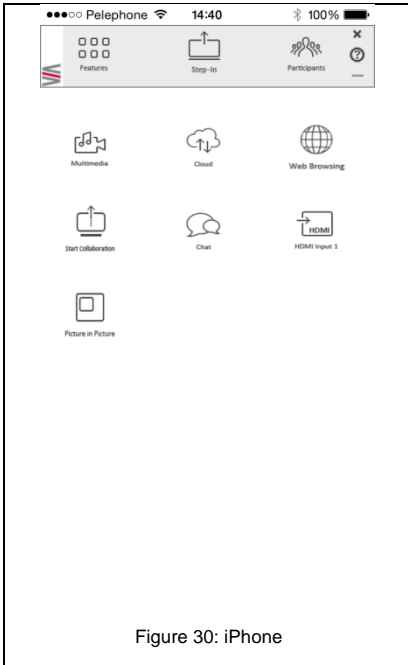

Figure 30: iPhone

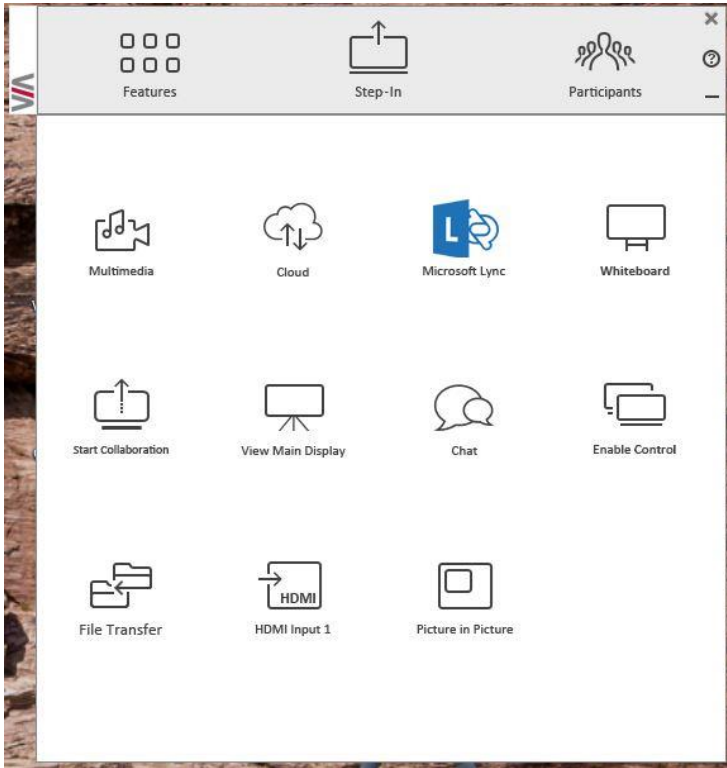

Figure 31: PC

5 Technical Specifications

PROCESSOR:	Quad core 2.9GHz, low power consumption
MAIN MEMORY:	4GB high speed
VIDEO INPUTS:	1 HDMI
VIDEO OUTPUTS:	1 HDMI, 1 DisplayPort
STORAGE:	64GB solid state drive
LAN:	Dual Gigabit LAN port, 10/100/1000 auto, 1 with iAMT 8.0 (not installed)
AUDIO:	Integrated High Definition Audio 5.1 channel HDMI embedded, 1 mic in and 1 line out on 3.5mm mini jacks
USB:	4 USB 3.0 ports, 1 USB 2.0 port
POWER CONSUMPTION:	120W power adapter (19V, 6.32A)
OPERATING TEMPERATURE:	0° to +40°C (32° to 104°F)
STORAGE TEMPERATURE:	-40° to +70°C (-40° to 158°F)
HUMIDITY:	10% to 90%, RHL non-condensing
DIMENSIONS:	11.7" x 2.2" x 8.3" W, D, H
WEIGHT:	2.3kg (5.0lbs)
INCLUDED ACCESSORIES:	3 power cords (US, EU, UK)
OPTIONAL:	2U rack adapter
Specifications are subject to change without notice at http://www.kramerelectronics.com	

LIMITED WARRANTY

The warranty obligations of Kramer Electronics for this product are limited to the terms set forth below.

What is Covered

This limited warranty covers defects in materials and workmanship in this product.

What is Not Covered

This limited warranty does not cover any damage, deterioration or malfunction resulting from any alteration, modification, improper or unreasonable use or maintenance, misuse, abuse, accident, neglect, exposure to excess moisture, fire, improper packing and shipping (such claims must be presented to the carrier), lightning, power surges, or other acts of nature. This limited warranty does not cover any damage, deterioration or malfunction resulting from the installation or removal of this product from any installation, any unauthorized tampering with this product, any repairs attempted by anyone unauthorized by Kramer Electronics to make such repairs, or any other cause which does not relate directly to a defect in materials and/or workmanship of this product. This limited warranty does not cover cartons, equipment enclosures, cables or accessories used in conjunction with this product.

Without limiting any other exclusion herein, Kramer Electronics does not warrant that the product covered hereby, including, without limitation, the technology and/or integrated circuit(s) included in the product, will not become obsolete or that such items are or will remain compatible with any other product or technology with which the product may be used.

How Long Does this Coverage Last

Three years as of this printing; please check our Web site for the most current and accurate warranty information.

Who is Covered

Only the original purchaser of this product is covered under this limited warranty. This limited warranty is not transferable to subsequent purchasers or owners of this product.

What Kramer Electronics will do

Kramer Electronics will, at its sole option, provide one of the following three remedies to whatever extent it shall deem necessary to satisfy a proper claim under this limited warranty:

1. Elect to repair or facilitate the repair of any defective parts within a reasonable period of time, free of any charge for the necessary parts and labor to complete the repair and restore this product to its proper operating condition. Kramer Electronics will also pay the shipping costs necessary to return this product once the repair is complete.
2. Replace this product with a direct replacement or with a similar product deemed by Kramer Electronics to perform substantially the same function as the original product.
3. Issue a refund of the original purchase price less depreciation to be determined based on the age of the product at the time remedy is sought under this limited warranty.

What Kramer Electronics will not do Under This Limited Warranty

If this product is returned to Kramer Electronics or the authorized dealer from which it was purchased or any other party authorized to repair Kramer Electronics products, this product must be insured during shipment, with the insurance and shipping charges prepaid by you. If this product is returned uninsured, you assume all risks of loss or damage during shipment. Kramer Electronics will not be responsible for any costs related to the removal or re-installation of this product from or into any installation. Kramer Electronics will not be responsible for any costs related to any setting up this product, any adjustment of user controls or any programming required for a specific installation of this product.

How to Obtain a Remedy under this Limited Warranty

To obtain a remedy under this limited warranty, you must contact either the authorized Kramer Electronics reseller from whom you purchased this product or the Kramer Electronics office nearest you. For a list of authorized Kramer Electronics resellers and/or Kramer Electronics authorized service providers, please visit our web site at www.kramerelectronics.com or contact the Kramer Electronics office nearest you.

In order to pursue any remedy under this limited warranty, you must possess an original, dated receipt as proof of purchase from an authorized Kramer Electronics reseller. If this product is returned under this limited warranty, a return authorization number, obtained from Kramer Electronics, will be required. You may also be directed to an authorized reseller or a person authorized by Kramer Electronics to repair the product.

If it is decided that this product should be returned directly to Kramer Electronics, this product should be properly packed, preferably in the original carton, for shipping. Cartons not bearing a return authorization number will be refused.

Limitation on Liability

THE MAXIMUM LIABILITY OF KRAMER ELECTRONICS UNDER THIS LIMITED WARRANTY SHALL NOT EXCEED THE ACTUAL PURCHASE PRICE PAID FOR THE PRODUCT. TO THE MAXIMUM EXTENT PERMITTED BY LAW, KRAMER ELECTRONICS IS NOT RESPONSIBLE FOR DIRECT, SPECIAL, INCIDENTAL OR CONSEQUENTIAL DAMAGES RESULTING FROM ANY BREACH OF WARRANTY OR CONDITION, OR UNDER ANY OTHER LEGAL THEORY. Some countries, districts or states do not allow the exclusion or limitation of relief, special, incidental, consequential or indirect damages, or the limitation of liability to specified amounts, so the above limitations or exclusions may not apply to you.

Exclusive Remedy

TO THE MAXIMUM EXTENT PERMITTED BY LAW, THIS LIMITED WARRANTY AND THE REMEDIES SET FORTH ABOVE ARE EXCLUSIVE AND IN LIEU OF ALL OTHER WARRANTIES, REMEDIES AND CONDITIONS, WHETHER ORAL OR WRITTEN, EXPRESS OR IMPLIED. TO THE MAXIMUM EXTENT PERMITTED BY LAW, KRAMER ELECTRONICS SPECIFICALLY DISCLAIMS ANY AND ALL IMPLIED WARRANTIES, INCLUDING, WITHOUT LIMITATION, WARRANTIES OF MERCHANTABILITY AND FITNESS FOR A PARTICULAR PURPOSE. IF KRAMER ELECTRONICS CANNOT LAWFULLY DISCLAIM OR EXCLUDE IMPLIED WARRANTIES UNDER APPLICABLE LAW, THEN ALL IMPLIED WARRANTIES COVERING THIS PRODUCT, INCLUDING WARRANTIES OF MERCHANTABILITY AND FITNESS FOR A PARTICULAR PURPOSE, SHALL APPLY TO THIS PRODUCT AS PROVIDED UNDER APPLICABLE LAW.

IF ANY PRODUCT TO WHICH THIS LIMITED WARRANTY APPLIES IS A "CONSUMER PRODUCT" UNDER THE MAGNUSON-MOSS WARRANTY ACT (15 U.S.C.A. §2301, ET SEQ.) OR OTHER APPLICABLE LAW, THE FOREGOING DISCLAIMER OF IMPLIED WARRANTIES SHALL NOT APPLY TO YOU, AND ALL IMPLIED WARRANTIES ON THIS PRODUCT, INCLUDING WARRANTIES OF MERCHANTABILITY AND FITNESS FOR THE PARTICULAR PURPOSE, SHALL APPLY AS PROVIDED UNDER APPLICABLE LAW.

Other Conditions

This limited warranty gives you specific legal rights, and you may have other rights which vary from country to country or state to state.

This limited warranty is void if (i) the label bearing the serial number of this product has been removed or defaced, (ii) the product is not distributed by Kramer Electronics or (iii) this product is not purchased from an authorized Kramer Electronics reseller. If you are unsure whether a reseller is an authorized Kramer Electronics reseller, please visit our Web site at www.kramerelectronics.com or contact a Kramer Electronics office from the list at the end of this document.

Your rights under this limited warranty are not diminished if you do not complete and return the product registration form or complete and submit the online product registration form. Kramer Electronics thanks you for purchasing a Kramer Electronics product. We hope it will give you years of satisfaction.



For the latest information on our products and a list of Kramer distributors, visit our Web site where updates to this user manual may be found.

We welcome your questions, comments, and feedback.

Web site: www.kramerelectronics.com

E-mail: info@kramerel.com



SAFETY WARNING

Disconnect the unit from the power supply before opening and servicing



P/N: 2900-300403



Rev: 1