

Install

AMS 5ICT LZ

5" ICT Surface-Mount Low Impedance Loudspeaker for Installation Applications

- Full range surface-mount loudspeaker for indoor and outdoor installation applications
- 50 Watts continuous, 200 Watts peak power
- 5" ICT (Inductive Coupling Technology) point source driver for extended frequency range and reliability
- 90° controlled conical dispersion for optimum coverage and forward gain
- High durability design for constant heavy usage in demanding applications
- 16 Ohm direct input for low impedance applications
- Optimised for Lab Gruppen low impedance LUCIA amplifiers with up to 8 AMS series loudspeakers per channel
- All components weather resistant to IP65 for outdoor use
- High temperature resistant ABS enclosure rated at 120°C
- Semi matt black paint finish fits unobtrusively in any environment
- Yoke bracket included for ease of installation
- Optional VARIBALL multi-angle bracket with secure clamp mechanism for accurate audience coverage
- Weatherproof cable gland cover to protect Phoenix* connectors
- 10-Year Warranty Program*
- Designed and engineered in the U.K.

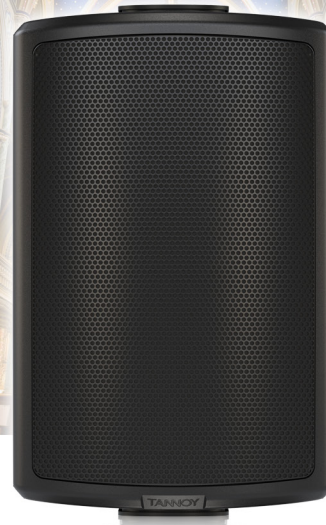

The AMS 5ICT LZ is a full bandwidth 200-Watt high sensitivity, low impedance loudspeaker that utilises a proprietary 5" ICT (Inductive Coupling Technology) point source driver to deliver consistent broadband directivity and provide exceptional long-term reliability. Thanks to its extended frequency range and 90° controlled conical dispersion pattern, the AMS 5ICT LZ is ideally suited for indoor and outdoor music applications including theme parks, hotels, restaurants and bars, retail stores, as well as corporate AV, residential developments, and houses of worship.

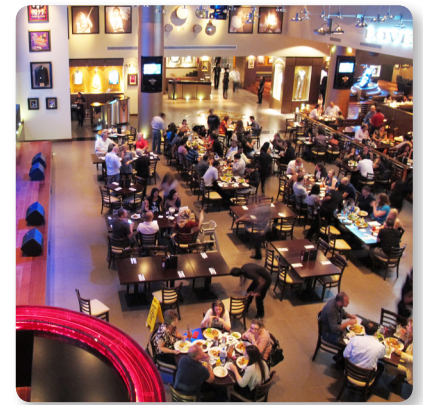

Weather-Resistant Enclosure

The elegantly styled semi matt black moulded enclosure blends beautifully into any décor. Additionally the AMS 5ICT LZ's design and performance has achieving an IP65 rating, making it an exceptional choice for both indoor and outdoor environments such as indoor swimming pools, saunas, or work areas with unusually high levels of dust or moisture, and outdoor applications where weather conditions are moderate. The included weatherproof cable gland protects the Phoenix* input and link output connectors.

*All third-party trademarks are the property of their respective owners. Their use neither constitutes a claim of the trademark nor affiliation of the trademark owners with Music Tribe. Product names are mentioned solely as a reference for compatibility, effects and/or components. Warranty details can be found at musictribe.com.

Install

AMS 5ICT LZ

5" ICT Surface-Mount Low Impedance
Loudspeaker for Installation Applications

Attractive and Easy to Install

The highly durable and heat resistant ABS enclosure features a black painted finish and comes with an aesthetically pleasing grille. Installation is quick and easy thanks to the included colour-matched yoke mounting bracket – and an optional VARIBALL multi-angle bracket is available separately.



LAB GRUPPEN Ready

The AMS 5ICT LZ is optimised for use with [LAB GRUPPEN LUCIA](#) amplifiers, which accommodate up to 8 AMS Series loudspeakers per channel.

You Are Covered

We always strive to provide the best possible Customer Experience. Our products are made in our own [Music Tribe](#) factory using state-of-the-art automation, enhanced production workflows and quality assurance labs with the most sophisticated test equipment available in the world. As a result, we have one of the lowest product failure rates in the industry, and we confidently back it up with a generous [Warranty](#) program.



Install

AMS 5ICT LZ

5" ICT Surface-Mount Low Impedance
Loudspeaker for Installation Applications

Frequency Response Sensitivity 1 W / 1 m

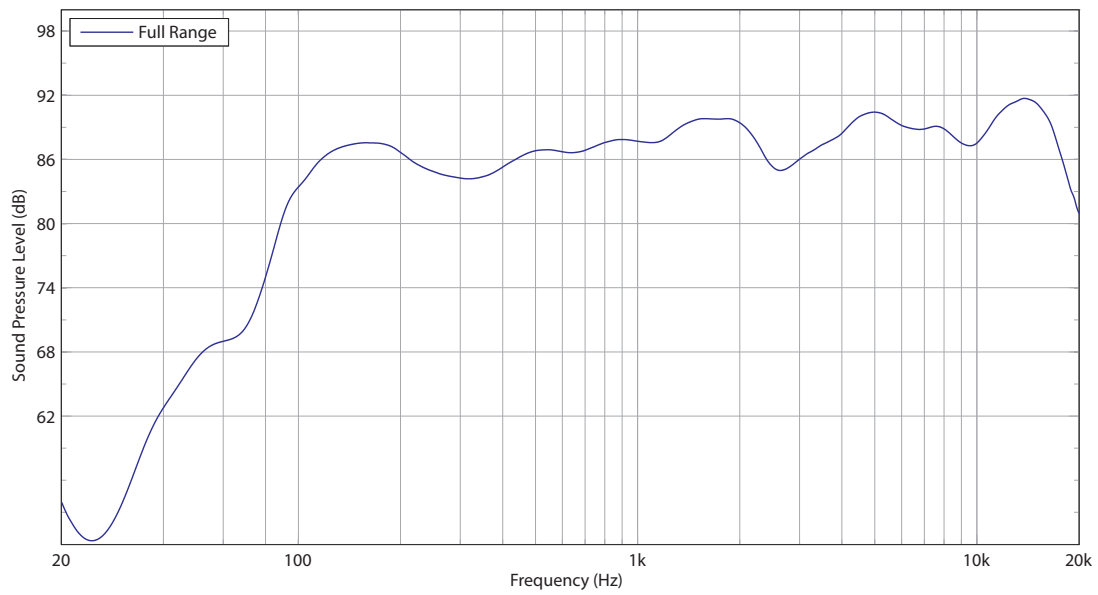

Impedance

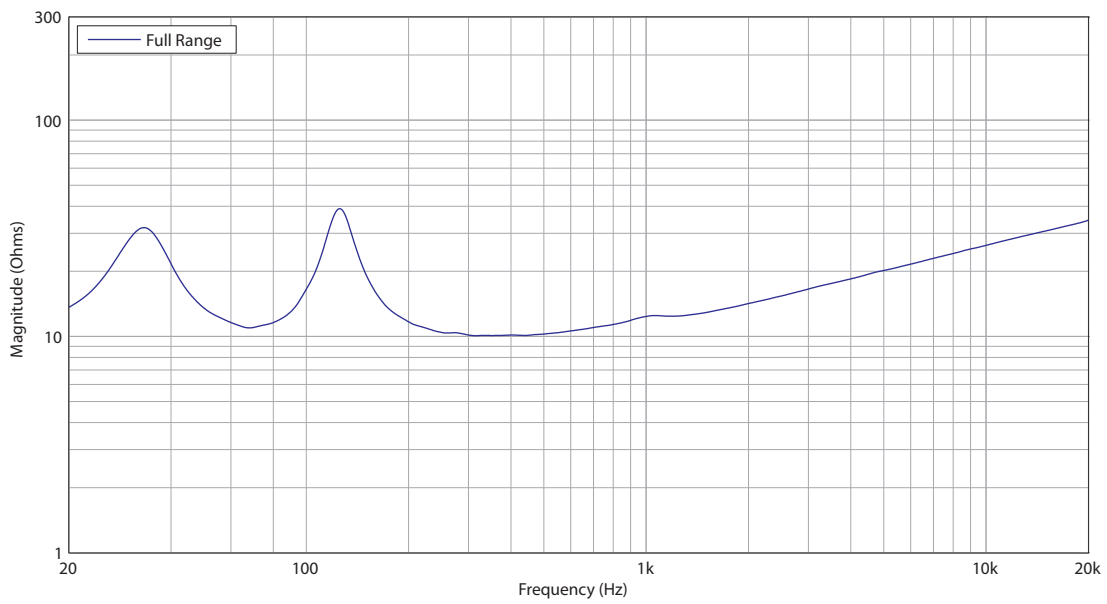

AMS 5ICT LZ

5" ICT Surface-Mount Low Impedance Loudspeaker for Installation Applications

Horizontal Beamwidth

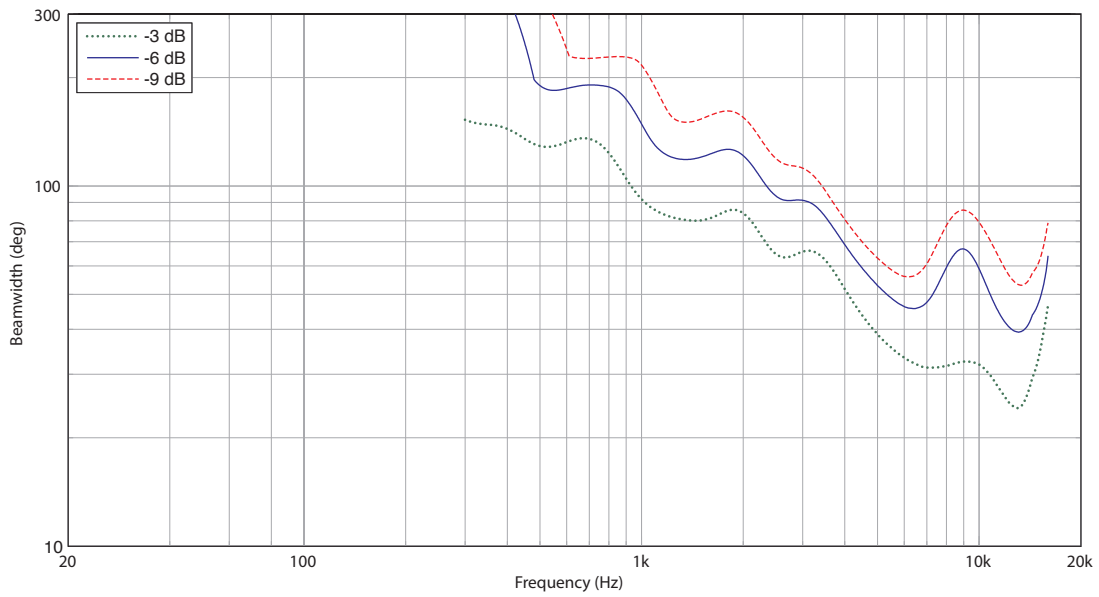

Vertical Beamwidth

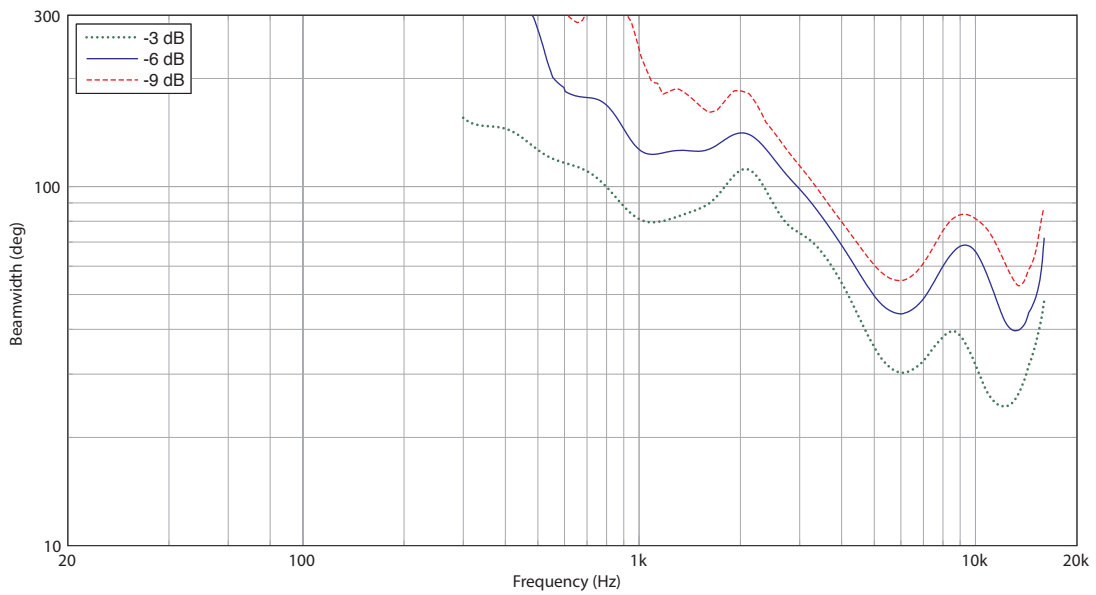

Install

AMS 5ICT LZ

5" ICT Surface-Mount Low Impedance Loudspeaker for Installation Applications

Horizontal Polar Plots

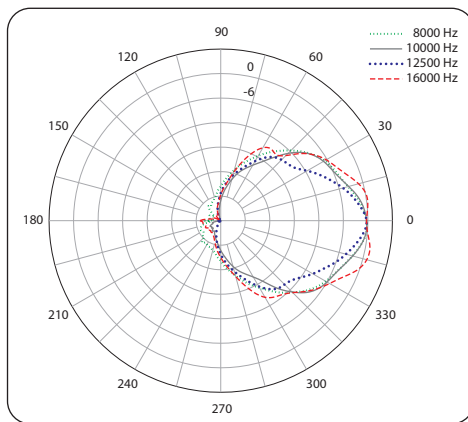
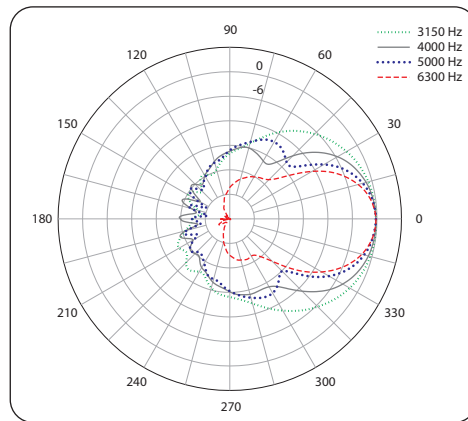
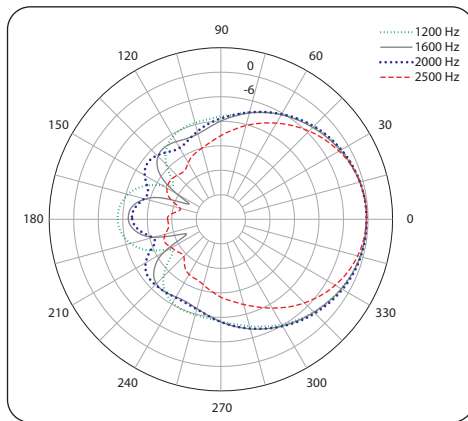
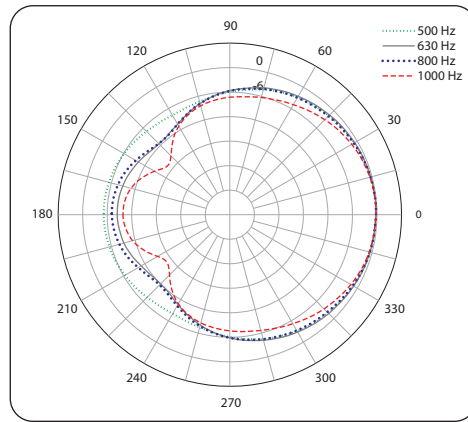
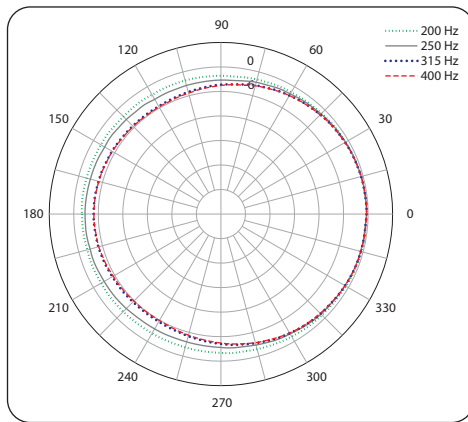

Install

AMS 5ICT LZ

5" ICT Surface-Mount Low Impedance Loudspeaker for Installation Applications

Vertical Polar Plots

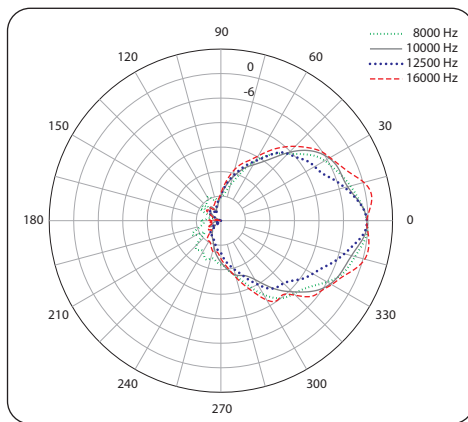
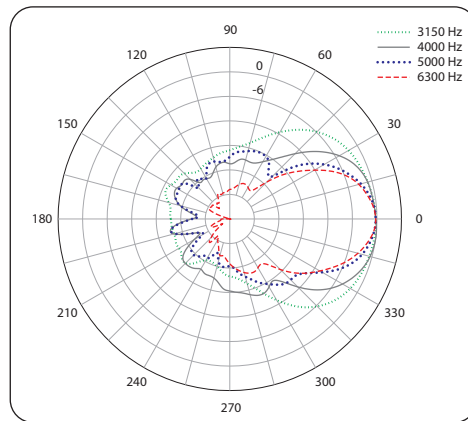
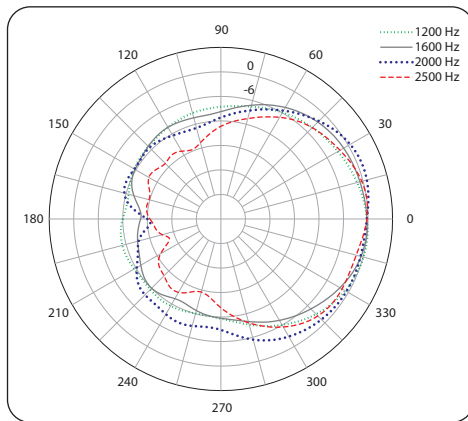
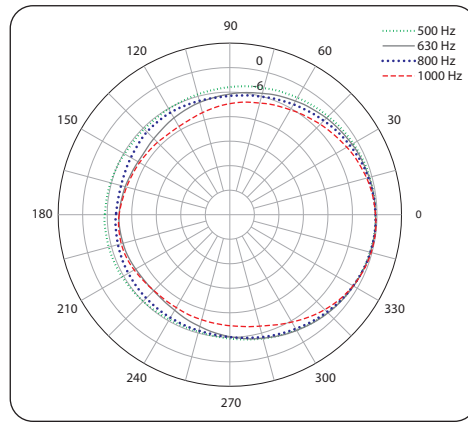
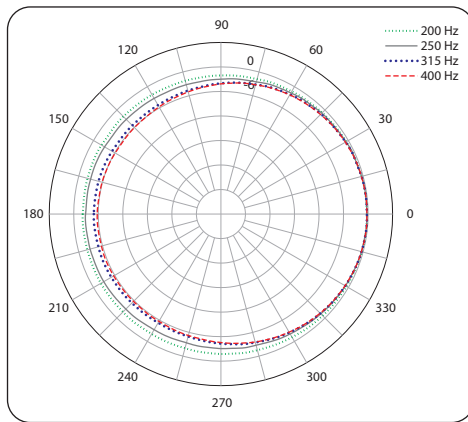

Install

AMS 5ICT LZ

5" ICT Surface-Mount Low Impedance Loudspeaker for Installation Applications

Dimensions

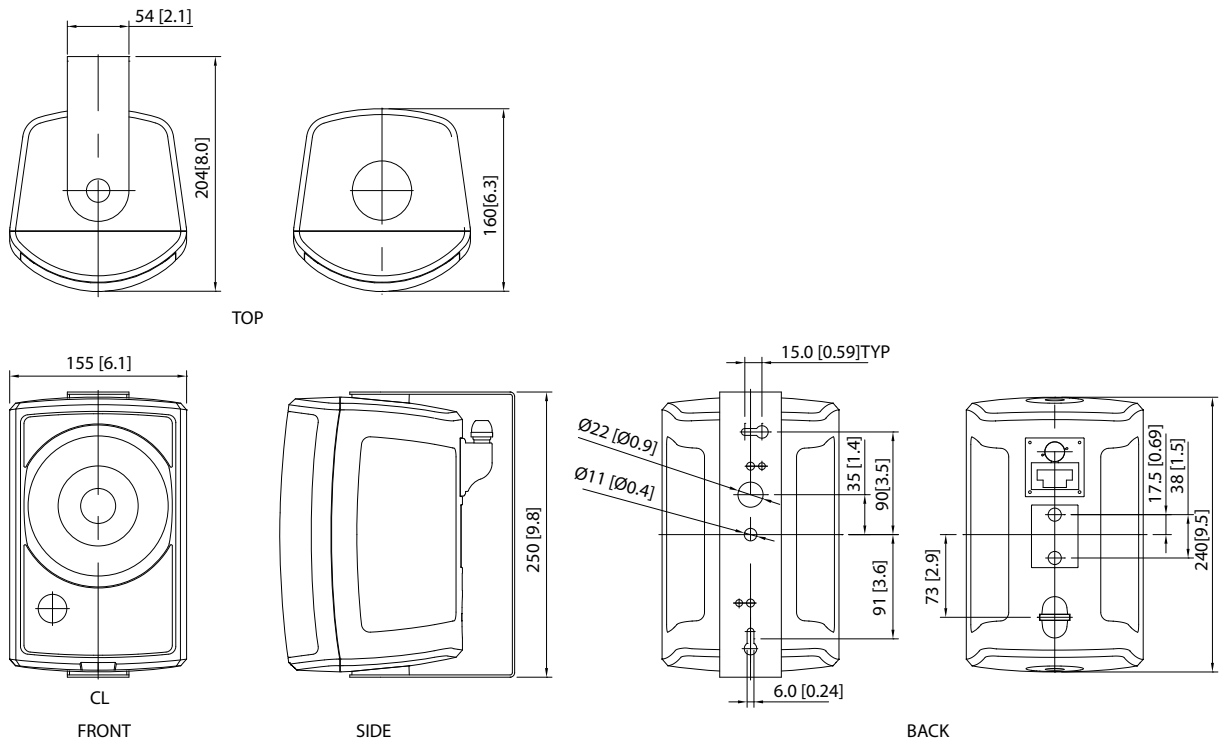

Install

AMS 5ICT LZ

5" ICT Surface-Mount Low Impedance
Loudspeaker for Installation Applications

Technical Specifications

Performance

Frequency response (-3 dB) ⁽¹⁾	90 Hz - 22 kHz
Frequency range (-10 dB) ⁽¹⁾	80 Hz - 30 kHz
System sensitivity (1 W @ 1m) ⁽²⁾	88 dB (1 W = 4 V for 16 Ohms)
Nominal Coverage Angle	90 degrees conical
Power Handling ⁽³⁾	
Average	50 W
Programme	100 W
Peak	200 W
Recommended Amplifier Power	100 W @ 16 ohms
Nominal Impedance (Lo, Z)	16 ohms
Rated maximum SPL	
Average	105 dB
Peak	111 dB

Transducers

Dual Concentric point source driver	—
Low Frequency	1 x 130 mm (5.00") treated multi fibre paper pulp cone
High Frequency	ICT

Physical

Enclosure	ABS
Grille	Steel, plated and painted
Connectors	Removable locking connector with screw terminals
Dimensions (H x W x D)	248.0 x 155.0 x 203.9 mm (9.77 x 6.10 x 8.03")
Net Weight (ea)	2.9 kg (6.4 lbs)
Shipped weight	3.5 kg (7.7 lbs)
Included Accessories	Yoke bracket
Packed Quantity	2

Install

AMS 5ICT LZ

5" ICT Surface-Mount Low Impedance
Loudspeaker for Installation Applications



Install

AMS 5ICT LZ

5" ICT Surface-Mount Low Impedance
Loudspeaker for Installation Applications



Install

AMS 5ICT LZ

5" ICT Surface-Mount Low Impedance
Loudspeaker for Installation Applications



Install

AMS 5ICT LZ

5" ICT Surface-Mount Low Impedance
Loudspeaker for Installation Applications



Install

AMS 5ICT LZ

5" ICT Surface-Mount Low Impedance
Loudspeaker for Installation Applications

AMS 5ICT LZ	
WIRING	PASSIVE
1+ / 2-	INPUT
3- / 4+	LINK
INPUT	POWER
16Ω	100W PROGRAM

TANNOY
DESIGNED AND ENGINEERED
IN THE U.K.



For service, support or more information contact the Tannoy location nearest you:

Europe
Music Tribe Brands UK Ltd.
 Tel: +44156 273 2290
 Email: CARECrea@musictribe.com
 CAREEnte@musictribe.com
 CARELife@musictribe.com

USA/Canada
Music Tribe Commercial NV Inc.
 Tel: +1 702 800 8290
 Email: CARECrea@musictribe.com
 CAREEnte@musictribe.com
 CARELife@musictribe.com

Japan
Music Tribe Services JP K.K.
 Tel: +81 3 6231 0453
 Email: CARECrea@musictribe.com
 CAREEnte@musictribe.com
 CARELife@musictribe.com

Music Tribe accepts no liability for any loss which may be suffered by any person who relies either wholly or in part upon any description, photograph, or statement contained herein. Technical specifications, appearances and other information are subject to change without notice. All trademarks are the property of their respective owners. Midas, Klark Teknik, Lab Gruppen, Lake, Tannoy, Turbosound, TC Electronic, TC Helicon, Behringer, Bugera and Coolaudio are trademarks or registered trademarks of Music Tribe Global Brands Ltd. © Music Tribe Global Brands Ltd. 2018 All rights reserved.

