



Control Your Video

**VIDEO WALLS VIDEO PROCESSORS
VIDEO MATRIX SWITCHES
EXTENDERS SPLITTERS WIRELESS
CABLES & ACCESSORIES**

8 Port HDMI LAN Splitter up to 120M over Single CAT5/6 with IR Support



Model #: HDM-C6IPX-SP8

© 2016 Avenview Inc. All rights reserved.

The contents of this document are provided in connection with Avenview Inc. ("Avenview") products. Avenview makes no representations or warranties with respect to the accuracy or completeness of the contents of this publication and reserves the right to make changes to specifications and product descriptions at any time without notice. No license, whether express, implied, or otherwise, to any intellectual property rights is granted by this publication. Except as set forth in Avenview Standard Terms and Conditions of Sale, Avenview assumes no liability whatsoever, and disclaims any express or implied warranty, relating to its products of Avenview Inc. is strictly prohibited.

Product Application & Market Sectors



Corporate



House Of Worship



Military



Residential



Education



Industrial



Medical



Aviation



TABLE OF CONTENTS

1.	GETTING STARTED	1
1.1	IMPORTANT SAFEGUARDS.....	1
1.2	SAFETY INSTRUCTIONS	1
1.3	REGULATORY NOTICES FEDERAL COMMUNICATIONS COMMISSION (FCC)	2
2.	INTRODUCTION.....	3
2.1	PACKAGE CONTENTS	4
2.2	BEFORE INSTALLATION.....	4
2.2.1	APPLICATION DIAGRAM.....	5
2.2.2	BEFORE INSTALLATION.....	6
2.3	DEVICE DESCRIPTION & LAYOUT.....	7
2.3.1	Front Panel & Rear Panel (Transmitter, HDM-C6IPX-SP8).....	7
2.3.2	Front Panel & Rear Panel (Receiver, HDM-C6IPX-R).....	7
2.4	IR CONTROL DESCRIPTION (HDM-C6IPX-SP8).....	8
3.	INSTALLATION.....	9
4.	GENERAL TROUBLESHOOTING.....	9
5.	SPECIFICATIONS.....	10
6.	PIN & WIRING STANDARD DEFINITION.....	11



SECTION I: GETTING STARTED

I.1 IMPORTANT SAFEGUARDS

Please read all of these instructions carefully before you use the device. Save this manual for future reference.

What the warranty does not cover

- Any product, on which the serial number has been defaced, modified or removed.
- Damage, deterioration or malfunction resulting from:
- Accident, misuse, neglect, fire, water, lightning, or other acts of nature, unauthorized product modification, or failure to follow instructions supplied with the product.
- Repair or attempted repair by anyone not authorized by us.
- Any damage of the product due to shipment.
- Removal or installation of the product.
- Causes external to the product, such as electric power fluctuation or failure.
- Use of supplies or parts not meeting our specifications.
- Normal wear and tear.
- Any other causes which does not relate to a product defect.
- Removal, installation, and set-up service charges.

I.2 SAFETY INSTRUCTIONS

The Avenview HDM-C6IPX-SP8, HDMI Extender has been tested for conformity to safety regulations and requirements, and has been certified for international use. However, like all electronic equipment's, the HDM-C6IPX-SP8 should be used with care. Read the following safety instructions to protect yourself from possible injury and to minimize the risk of damage to the unit.

- ⚠ Do not dismantle the housing or modify the module.
- ⚠ Dismantling the housing or modifying the module may result in electrical shock or burn.
- ⚠ Refer all servicing to qualified service personnel.
- ⚠ Do not attempt to service this product yourself as opening or removing housing may expose you to dangerous voltage or other hazards
- ⚠ Keep the module away from liquids.
- ⚠ Spillage into the housing may result in fire, electrical shock, or equipment damage. If an object or liquid falls or spills on to the housing, unplug the module immediately.
- ⚠ Have the module checked by a qualified service engineer before using it again.
- ⚠ Do not use liquid or aerosol cleaners to clean this unit. Always unplug the power to the device before cleaning.



1.3 REGULATORY NOTICES FEDERAL COMMUNICATIONS COMMISSION (FCC)

This equipment has been tested and found to comply with part 15 of the FCC rules. These limits are designed to provide reasonable protection against harmful interference in a residential installation.

Any changes or modifications made to this equipment may void the user's authority to operate this equipment.

Warning symbols

Description



ONLY USE THE PROVIDED POWER CABLE OR POWER ADAPTER SUPPLIED. DO NOT TAMPER WITH THE ELECTRICAL PARTS. THIS MAY RESULT IN ELECTRICAL SHOCK OR BURN.



DO NOT TAMPER WITH THE UNIT. DOING SO WILL VOID THE WARRANTY AND CONTINUED USE OF THE PRODUCT.



THE VIDEO BOARDS ARE VERY SENSITIVE TO STATIC. PLEASE ENSURE IF RACK MOUNTED OR INSTALLED ON A SURFACE, IT SHOULD BE IN A GROUNDED ENVIROMENT.



2. INTRODUCTION

Avenview HDM-C6IPX-SP8, HDMI Distributed Amplifier is a dedicated 8 port HD splitter designed to provide extra distance and extra IR support to eight displays over CAT6 cable. We have engineered a newer chipset providing extra PPI in resolution and lower bandwidth so the user can extend any HD display with the resolutions 480i@60Hz to 1080p@50Hz/60Hz to 394 feet (120 meters) away from your HDMI or Dvl-D source.

A: The 8 port Tx can extend the compatible Rx units 120 meters over CAT5/6 cable connection point to multipoint.

- Extends HDMI up to 120m over single CAT5E/6
- Supports HDMI, EDID, Support HDCp
- Supports resolution 480i@60Hz to 1080p@50Hz/60Hz
- IR Signal support 20-60kHz
- LED Front Panel and Rear panel indicators



2.1 PACKAGE CONTENTS

Before you start the installation of HDM-C6IPX-SP8, please check the package contents.

1	HDM-C6IPX-SP8 Transmitter unit	x 1	
2	HDM-C6IPX-R Receiver unit (NOT INCLUDED)	x 1	
3	IR EXTENDER	x 1	
4	IR BLASTER	x 1	
5	POWERADAPTER (5V DC)	x 2	
6	MOUNTING BRACKET		
7	USER'S MANUAL	x 1	

2.2 BEFORE INSTALLATION

- Place the product in an even and stable location. If the product falls down or drops, it may cause an injury or malfunction.
- Don't place the product in too high temperature (over 50°C), too low temperature (under 0°C) or high humidity.
- Use the DC power adapter with correct specifications. If inappropriate power supply is used then it may cause a fire.
- Do not twist or pull by force the ends of the HDMI/UTP cable. It can cause malfunction.



2.2.1 APPLICATION DIAGRAM

HDMI-C61PX-SP8 LAYOUT 1

1080p(1100x1080) = 120m (294 feet) CAT5E 310MHz
1080p(1020x1080) = 100m (330 feet) CAT5E 300-600MHz

CABLE INDEX

Input / Output

CAT 5E/6A/7

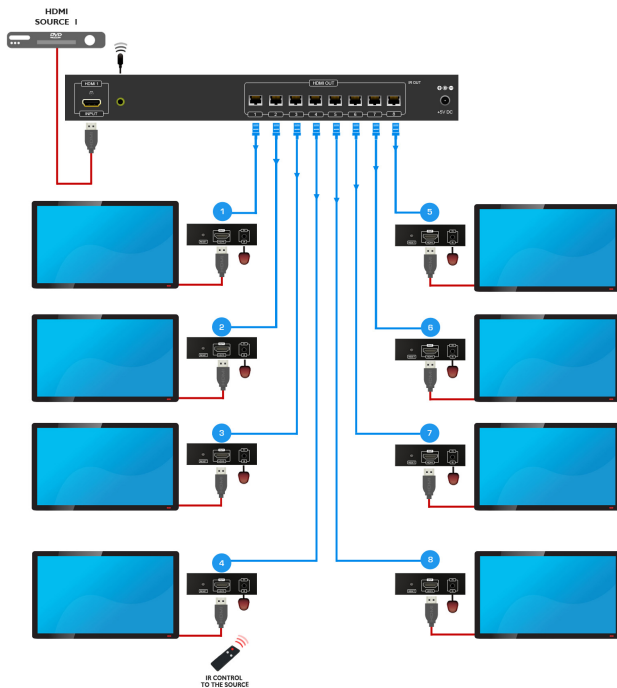



We highly recommend achieving best results with our HDM-C6IPX-SP8 you acquire a high quality 26 or 24 AWG HDMI cable with the below specifications to maintain signal integrity and distances.

- length: 5m (16ft) to 15m (50ft)
- Bandwidth: 10.2 Gbps data transfer rate
- Supports Resolution: up to 1080p @ 24Hz / 50/60Hz/3D - Conductor gauge: 26 / 24 AWG
- Deep Color
- 3D Capable
- CEC
- Ethernet Channel
- Audio Return Channel
- Connector 1: HDMI (Type A) Male
- Connector 2: HDMI (Type A) Male

Selecting the Right Cable

Cable length - Always round up when estimating connection distances. It's better to have a bit too much cable than to come up short.

Cable Type - If you plan to enjoy 1080p content (i.e., Blu-ray Discs) or any advanced display technologies (3D, 4K, Deep Color, 120Hz refresh rates, etc.), a High Speed HDMI Cable is recommended.

For 1080i or 720p signals (most cable, broadcast, and satellite HD signals), a Standard HDMI Cable is recommended.

Longer Cable Runs

In complex home theater set-ups, such as multi-room environments, components can be placed relatively far from each other. There are several technologies available for these installations:

25 to 100 feet - If you need to send a 1080p signal more than 25 feet, or a 1080i signal more than 49 feet, active Avenview extender will help boost the HDMI signal to compensate.



2.3 DEVICE DESCRIPTION & LAYOUT

This product is packaged as a set which includes a Transmitter and a Receiver.

2.3.1 Front Panel & Rear Panel (Transmitter, HDM-C6IPX-SP8)

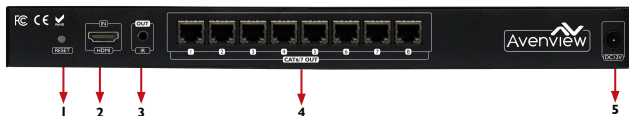

1 RESET: To rest the unit when no link is established	2 HDMI IN: Connect to HDMI source Max 35ft via HDMI Cable
3 CAT5E/6 OUT: plug in a Cat-5E/6 cable to link and send data (video and audio) to the Receiver unit.	4 IR: Plug the IR Blaster cable for IR signal being received. Place IR Blaster within direct site of the device being controlled



6 LED: Power LED will be active when power is connected
7 LED: Link LED will be active when CAT/5E/6 and Receivers are connected and sending video and audio signals to the HDMI Display

2.3.2 Front Panel & Rear Panel (Compatible Receiver, HDM-C6IPX-R)

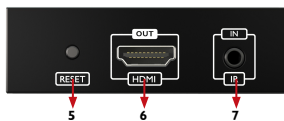

1 +5V DC: Connect to the 5V DC power supply Power LED will light BLUE .	2 CAT5E/6 OUT: Plug in a Cat-5E/6 cable to link and receive data (video and audio) from the sender unit or network switch.
3 DATA LED: When data is transmitting from the source the led will continuously flash YELLOW .	4 LINK LED: When connected to RX or network switch the LED will light GREEN .
5 RESET: To rest the unit when no link is established	6 HDMI OUT: Connect to HDMI display Max 35ft via HDMI Cable
7 IR IN: Plug the IR Extender cable for IR signal being received. Place IR Extender within direct line of site with the IR Remote.	



2.4 IR CABLE DESCRIPTION

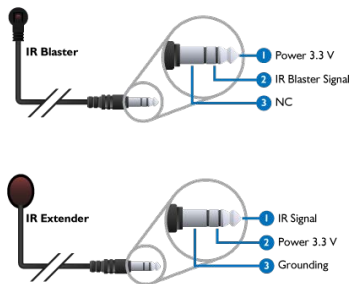

IR Sockets

-- **IR OUT** -IR BLASTER: plug in the IR blaster to the HDMC61PX-5 to emit all IR command signals received from the IR Extender plugged into the Rx (Monitor Side) to control the devices corresponding to the IR signals. Example: Set Top Box or DVD player (**The Source**).

-- **IR IN** - IR EXTENDER: plug in the IR Extender into the (RX) Receiver (Monitor Side) to receive all IR command signals from the IR remote controls of the corresponding source. Example: Set Top Box or DVD player (**IR Remote Control**).

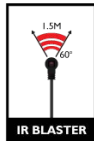
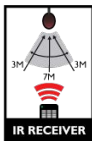

Important IR signals can be affected by very bright fluorescent light and also EMI Interference on the cables so be aware of where you place and position your IR cables. Please follow these instructions for best results.



3. INSTALLATION

Please ensure all the package contents are all received before proceeding.

To setup Avenview HDM-C6IPX-SP8 follow these steps for connecting to a device:

1. Connect your HDMI source (such as a Blu-ray Disc player) to Transmitter (HDM-C6IPX-SP8).
2. Connect your HDMI display (such as a LCD TV) to the receiving 8 unit HDM-C6IPX-R.
3. Connect your CAT-5E/6 follow the standards of TIA-568BI AN cable between the transmitting and receiving units.
4. Make sure CAT-5E/6 LAN cable is tightly connected and not loose.
5. Plug in 12v DC power cord to the power jack of the transmitting unit HDM-C6IP X-SP8
6. Plug in the 8 x 5v DC power cord to the power jack of the receiving unit HDM-C6IP X-R.

4. GENERAL TROUBLESHOOTING

PROBLEM	POSSIBLE SOLUTION
NO IMAGE	<ul style="list-style-type: none">• Check if connection to the source and the display are correct.• Ensure that display device supports 480i@60Hz to 1080p@50Hz/60Hz
SCREEN DEFECTS APPEAR	<ul style="list-style-type: none">• Check the DVI and HDMI connection
DATA TRANSMISSION LIGHT FLASHING SLOW	<ul style="list-style-type: none">• Check both units and make sure the TX and RX are not Reversed• Check the source device is powered ON
DATA TRANSMISSION LIGHT FLASHING FAST/NO IMAGE	<ul style="list-style-type: none">• Check Graphics card on PC/HD Player. This product supports up to 480i@60Hz to 1080p@50Hz/60Hz resolution.
NO LIGHT ON DATA TRANSMISSION	<ul style="list-style-type: none">• Check Network cable only use TIA-568B Standard• Network cable run is out of range



5. SPECIFICATIONS

ITEM	DESCRIPTION	
UNITS	HDM-C6IPX-SP8	HDM-C6IPX-R
UNIT DESCRIPTION	HDMI Transmitter	Compatible HDMI Receiver
HDMI COMPLIANCE	FULL HD	
HDCP COMPLIANCE	Yes	
VIDEO BANDWIDTH	HDTchipset OVER CAT5/6	
SUPPORTED RESOLUTIONS	480i@60Hz, 480p@60Hz, 576i@50Hz, 576p@50Hz, 720p@50/60Hz, 1080i@50/60Hz, 1080p@50/60Hz	
RESOLUTION AND DISTANCE (24-BIT)	Full HD: (1080p)-120meter (394feet) (CAT6)	
AUDIO SUPPORT	Surround Sound (up to 7.1 Ch) or Stereo Digital Audio	
IR PASS-THRU	Supports 20~60KHz IR devices	
RS-232 SUPPORT	NO	
INPUT	1x HDMI	1x RJ45, 1x IR IN
OUTPUT	8 x RJ45, 1x IR Out	1x HDMI
HDMI CONNECTOR	Type A (19 pin female)	
RJ45 CONNECTOR	WE/SS 8p8C with 2 LED	
POWER ADAPTER	DC 12v/ 3A	
POWER CONSUMPTION	24W Max	
DIMENSION L X W X H	11.7" x 4.3" x 1.16"	
WEIGHT	1lbs	
<i>Environmental</i>		
OPERATING TEMPERATURE	32° ~ 140°F (0° to 60°C)	
STORAGE TEMPERATURE	-4° ~ 140°F (-20° ~ 60°C)	
RELATIVE HUMIDITY	20~90% RH.(no condensation)	

PERFORMANCE GUIDE FOR HDMI OVER CATEGORY CABLE TRANSMISSION

PERFORMANCE RATING		TYPE OF CATEGORY CABLE		
WIRING	SHIELDING	CAT5	CAT5E	CAT6
SOLID	u NSHIEI DED (u Tp)	***	****	*****
	SHIEI DED (STp)	***	***	****
STRANDED	u NSHIEI DED (u Tp)	*	**	**
	SHIEI DED (STp)	*	*	**
TERMINATION		pl EASE u SE EIA/TIA-568-B TERMINATION (T568B) AT Any TIME		



6. PIN & WIRING STANDARD DEFINITION

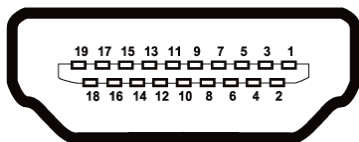

TYPE A (RECEPTACLE) HDMI

pin 1	TMDS Data2+	pin 11	TMDS Clock Shield
pin 2	TMDS Data2 Shield	pin 12	TMDS Clock-
pin 3	TMDS Data2-	pin 13	CEC
pin 4	TMDS Data1+	pin 14	Reserved (N.C. on device)
pin 5	TMDS Data1 Shield	pin 15	SCI
pin 6	TMDS Data1-	pin 16	SDA
pin 7	TMDS Data0+	pin 17	DDC/CEC Ground
pin 8	TMDS Data0 Shield	pin 18	+5v power
pin 9	TMDS Data0-	pin 19	Hot plug Detect
pin 10	TMDS Clock+		

CAT5E/6 WIRING STANDARD

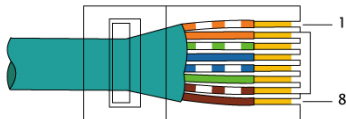

EIA/TIA-568B



Notes





Avenview Warranty Certificate

AVENVIEW CORP. ("Avenview") warrants Avenview-branded product(s) contained in the original packaging against defects in materials and workmanship when used normally in accordance with Avenview's enclosed manual guidelines for a period of THREE (3) YEARS from the date of original retail purchase - Warranty Period. Avenview's published guidelines include but are not limited to information contained in technical specifications, user manuals and service communications.

LABOR: During the Warranty Period of THREE (3) YEARS, Avenview will repair or replace the product(s) at no cost using new or used parts equivalent to novel performance and reliability if the product(s) is determined to have abide by Avenview's published guidelines. Cost of Labor applicable to product(s) after Warranty Period. For labor costs, please contact support@avenview.com.

PARTS: During the Warranty Period of THREE (3) YEARS, Avenview will supply new or rebuilt replacements in exchange for defective parts of the product(s) at no cost if the product(s) is determined to have abide by Avenview's published guidelines. Cost of Parts applicable to product(s) after Warranty Period. For part(s) costs, please contact support@avenview.com.

To obtain Warranty: (a) proof of purchase in the form of a bill of sale or receipted invoice reflecting that the registered product(s) is within warranty period must be presented to obtain warranty service; (b) product(s) must be registered at time of purchase. Failure to do so will result in applicable parts and labor charges. Returning product(s) must be shipped in Avenview's original packaging or in packaging pertaining equal degree of protection to Avenview's. Both Avenview and purchaser are responsible for freight charges and brokerages when shipping the product(s) to the receiver.

NOT COVERED BY THIS WARRANTY

This warranty does not apply to any non-Avenview branded product(s); non-registered Avenview product(s). This warranty does not apply: (a) to cosmetic damage, including but not limited to scratches, dents and broken cords; (b) to damage caused by use with another product; (c) to damage caused by accident, abuse, misuse, liquid contact, fire, earthquake or other external cause; (d) to damage caused by operating the Avenview product(s) outside Avenview's manuals or guidelines; (e) to damage caused by service performed by anyone who is not a representative of Avenview or an Avenview authorized personnel; (f) to defects caused by normal wear and tear or otherwise due to the normal aging of the Avenview product(s); or (g) if any serial number has been removed or defaced from the Avenview product(s).

AVENVIEW IS NOT LIABLE FOR DIRECT, SPECIAL, INCIDENTAL OR CONSEQUENTIAL DAMAGES RESULTING FROM ANY BREACH OF WARRANTY OR CONDITION, OR UNDER ANY OTHER LEGAL THEORY, INCLUDING BUT NOT LIMITED TO LOSS OF USE, LOSS OF REVENUE, LOSS OF ACTUAL OR ANTICIPATED PROFITS (INCLUDING LOSS OF PROFITS ON CONTRACTS), LOSS OF THE USE OF MONEY, LOSS OF ANTICIPATED SAVINGS, LOSS OF BUSINESS, LOSS OF OPPORTUNITY, LOSS OF GOODWILL, LOSS OF REPUTATION, LOSS OF, DAMAGE TO, COMPROMISE OR CORRUPTION OF DATA; OR ANY INDIRECT OR CONSEQUENTIAL LOSS OR DAMAGE. **REPAIR OR REPLACEMENT AS PROVIDED UNDER THIS WARRANTY IS THE EXCLUSIVE REMEDY OF THE CONSUMER.**

Some states do not allow the inclusion or limitation of incidental or consequential damages, or allow limitations on duration implements of the Warranty Period; therefore the above limitations or exclusions may not be applicable to you. This warranty gives you specific legal rights, and you may have other rights which vary from state to state.



275 Woodward Avenue, Katonah, NY 14217
1.866.508.0269





Control Your Video...

TECHNICAL SUPPORT

CONTACT US



Phone: 1 (866) 508 0269



Email: support@avenview.com



USA Head Office Avenview Corp. 275 Woodward Avenue Kanmore, NY 14217

USA Head Office

Office Avenview
Corp. 275 Woodward Avenue
Kenmore, Ny 14217
phone: + 1.716.218.4100 ext223
fax: + 1.866.387-8764
Email: info@avenview.com

Canada Sales

Avenview
151 Esna park Drive, unit 11 & 12
Markham, Ontario, L3R 3B1
phone: 1.905.907.0525
fax: 1.866.387.8764
Email: info@avenview.com

Avenview Europe

Avenview Europe
Demkagew 11
3555 HW utrecht
Netherlands
phone: +31 (0)85 2100- 613
Email: info@avenview.eu

Avenview Hong Kong

unit 8, 6/f., Kwai Cheong Centre,
50 Kwai Cheong Road,
Kwai Chung, N.T.
Hong Kong
phone: 852-3575 9585
Email: wenxi@avenview.com

Disclaimer

While every precaution has been taken in the preparation of this document, Avenview Inc. assumes no liability with respect to the operation or use of Avenview hardware, software or other products and documentation described herein, for any act or omission of Avenview concerning such products or this documentation, for any interruption of service, loss or interruption of business, loss of anticipatory profits, or for punitive, incidental or consequential damages in connection with the furnishing, performance, or use of the Avenview hardware, software, or other products and documentation provided herein.

Avenview Inc. reserves the right to make changes without further notice to a product or system described herein to improve reliability, function or design. With respect to Avenview products which this document relates, Avenview disclaims all express or implied warranties regarding such products, including but not limited to, the implied warranties of merchantability, fitness for a particular purpose, and non-infringement.