



AV Connectivity, Distribution And Beyond...

VIDEO WALLS VIDEO PROCESSORS
VIDEO MATRIX SWITCHES
EXTENDERS SPLITTERS WIRELESS
CABLES & ACCESSORIES

Advanced Quad Screen Multiviewer



Model #: DVI-SPLITPRO-4X

© 2013 Avenview Inc. All rights reserved.

The contents of this document are provided in connection with Avenview Inc. ("Avenview") products. Avenview makes no representations or warranties with respect to the accuracy or completeness of the contents of this publication and reserves the right to make changes to specifications and product descriptions at any time without notice. No license, whether express, implied, or otherwise, to any intellectual property rights is granted by this publication. Except as set forth in Avenview Standard Terms and Conditions of Sale, Avenview assumes no liability whatsoever, and disclaims any express or implied warranty, relating to its products of Avenview Inc. is strictly prohibited.

TABLE OF CONTENTS

1.	GETTING STARTED	1
1.1	IMPORTANT SAFEGUARDS.....	1
1.2	SAFETY INSTRUCTIONS	1
1.3	REGULATORY NOTICES FEDERAL COMMUNICATIONS COMMISSION (FCC)	2
2.	INTRODUCTION	3
2.1	PACKAGE CONTENTS	4
2.2	BEFORE INSTALLATION	5
2.3	PANEL DESCRIPTION.....	5
	DVI-SPLITPRO-4X REAR PANEL.....	5
2.4	DVI-SPLITPRO-4X I/O CONNECTORS	6
3.	INSTALLATION.....	8
4.	SOFTWARE INSTALLATION	8
5.	SOFTWARE SETUP GUIDE	9
5.	SOFTWARE CONFIGURATION.....	19
6.	CASCADE INSTALLATION	20
7.	FRONT PANEL CONTROLS.....	23
	7.1 FRONT PANEL PUSH BUTTONS DESCRIPTION	23
	7.2 FRONT PANEL PUSH BUTTONS FUNCTIONS.....	24
	7.3 SELECTING PIP WINDOW ARRANGEMENT	24
8.	ON SCREEN DISPLAY MENU TREE	25
11.	IR REMOTE CONTROL.....	26
12.	SPECIFICATIONS	27
13.	RESOLUTIONS COMPATIBILITY.....	28
	13.1 DVI / COMPONENT / VGA.....	28
	13.2 DVI-OUT	28
14.	GENERAL TROUBLESHOOTING.....	29



SECTION I: GETTING STARTED

I.1 IMPORTANT SAFEGUARDS

Please read all of these instructions carefully before you use the device. Save this manual for future reference.

What the warranty does not cover

- Any product, on which the serial number has been defaced, modified or removed.
- Damage, deterioration or malfunction resulting from:
 - Accident, misuse, neglect, fire, water, lightning, or other acts of nature, unauthorized product modification, or failure to follow instructions supplied with the product.
 - Repair or attempted repair by anyone not authorized by us.
 - Any damage of the product due to shipment.
 - Removal or installation of the product.
 - Causes external to the product, such as electric power fluctuation or failure.
 - Use of supplies or parts not meeting our specifications.
 - Normal wear and tear.
 - Any other causes which does not relate to a product defect.
- Removal, installation, and set-up service charges.

I.2 SAFETY INSTRUCTIONS

The Avenview DVI-SPLITPRO-4X Advanced Quad Screen Video Processor has been tested for conformance to safety regulations and requirements, and has been certified for international use. However, like all electronic equipment's, the DVI-SPLITPRO-4X should be used with care. Read the following safety instructions to protect yourself from possible injury and to minimize the risk of damage to the unit.



- ⚠ Do not dismantle the housing or modify the module.
- ⚠ Dismantling the housing or modifying the module may result in electrical shock or burn.
- ⚠ Refer all servicing to qualified service personnel.
- ⚠ Do not attempt to service this product yourself as opening or removing housing may expose you to dangerous voltage or other hazards
- ⚠ Keep the module away from liquids.
- ⚠ Spillage into the housing may result in fire, electrical shock, or equipment damage. If an object or liquid falls or spills on to the housing, unplug the module immediately.
- ⚠ Have the module checked by a qualified service engineer before using it again.
- ⚠ Do not use liquid or aerosol cleaners to clean this unit. Always unplug the power to the device before cleaning.



1.3 REGULATORY NOTICES FEDERAL COMMUNICATIONS COMMISSION (FCC)

This equipment has been tested and found to comply with Part 15 of the FCC rules. These limits are designed to provide reasonable protection against harmful interference in a residential installation.

Any changes or modifications made to this equipment may void the user's authority to operate this equipment.

Warning symbols	Description
	<p>ONLY USE THE PROVIDED POWER CABLE OR POWER ADAPTER SUPPLIED. DO NOT TAMPER WITH THE ELECTRICAL PARTS. THIS MAY RESULT IN ELECTRICAL SHOCK OR BURN.</p>
	<p>DO NOT TAMPER WITH THE UNIT. DOING SO WILL VOID THE WARRANTY AND CONTINUED USE OF THE PRODUCT.</p>
	<p>THE VIDEO BOARDS ARE VERY SENSITIVE TO STATIC. PLEASE ENSURE IF RACK MOUNTED OR INSTALLED ON A SURFACE, IT SHOULD BE IN A GROUNDED ENVIROMENT.</p>
	<p>⚠ WARNING</p> <p>Read & understand user guide before using this device.</p> <p>Failure to follow the proper installation instructions could result in damage to the product and preventing expected results.</p>



2. INTRODUCTION

The **DVI-SPLITPRO-4X Advanced Quad Screen Multiviewer with IR Remote Control** is an advanced video processor for most multimedia presentations. This unit is an ideal solution for applications where four video signals must be displayed on a single display. It supports up to 16 types of video inputs, of which four can be outputted simultaneously with the desired display layout through software control. The advanced video processor allows you to manipulate the output images to various sizes and multiple positions on the desired display. This unit can be controlled with the ease of the front panel buttons, IR remote and RS232 via a cable or control system, this functionality allows the user to easily set the desired outputs by 5 preset layouts or 8 custom layouts saved by the user.

The embedded scalar converts signals from input sources to match the native resolution of monitors, flat panel displays, projectors as well as user-selectable output settings up to WUXGA (1920x1200). Dual outputs are provided in both analog (VGA) and digital (DVI) or (DVI/HDMI) format, one is connected to remote display and the other is connected to on-site display for real time monitoring.

- Support six most popular video formats: four VGA, four DVI/HDMI, four component, four S-Video and four composite inputs
- Input resolution support from 640x480 to 1920x1200, interlaced or progressive.
- DVI & HDMI
- Support HDCP 1.1
- Dual outputs (DVI / VGA), 640x480 to 1920x1200.
- Video background available.
- Adjustable size & position through software.
- Dynamic transition for video sizing and positioning
- Titles, borders and colored backgrounds.
- Resize, position, zoom & pan and blend output video.
- Image parameters and layouts are automatically saved in flash memory and can be recalled for later use.
- Several Image parameters and layouts can be saved in computers and can be loaded for later use.
- Video parameters adjustable (brightness, contrast, color temperature, etc.).
- User-selectable output settings, up to 1920x1200.
- Use as a Video Splitter, a Video Converter and a Video Switcher.
- Firmware upgradable for support of new features and technology enhancements.
- Control through RS-232/RS-485 over Cat-5 and IR Remote Control
- Can be cascaded to obtain more images using RS-485 control path
- Control protocol available for customer proprietary design
- IRU Size



2.1 PACKAGE CONTENTS

Before you start the installation of the converter, please check the package contents.

1	DVI-SPLITPRO-4X	XI	
2	DVI – DVI & VGA BREAKOUT CABLE	XI	
3	VGA TO COMPONENT BREAKOUT CABLE	XI	
4	DVI TO VGA ADAPTER	XI	
5	Y CABLE –S-VIDEO TO S-VIDEO-CVBS	XI	
6	RACK MOUNTING KIT	XI	
7	RS232 TO USB ADAPTER	XI	
8	IR REMOTE CONTROL	XI	
9	SOFTWARE CD	XI	
10	AC POWER SUPPLY	XI	
11	USER'S MANUAL	XI	



2.2 BEFORE INSTALLATION

- Put the product in an even and stable location. If the product falls down or drops, it may cause an injury or malfunction.
- Don't place the product in too high temperature (over 50°C), too low temperature (under 0°C) or high humidity.
- Use the DC power adapter with correct specifications. If inappropriate power supply is used then it may cause a fire.
- Do not twist or pull by force ends of the video cable. It can cause malfunction.

2.3 PANEL DESCRIPTION

Avenview Advanced Quad Screen Video Processor (DVI-SPLITPRO-4X) has 16 inputs and accepts both graphics and video signals, which come from computers (DVI or VGA), composite, and component video sources respectively. You can pick up four of the ten inputs and then display four of them simultaneously on the same screen.

DVI-SPLITPRO-4X REAR PANEL



To reset the DVI-SPLITPRO-4X to factory default settings: Turn on the DVI-SPLITPRO-4X then switch both DIP Switches simultaneously up and down to reset the unit to factory default settings



The DVI input and output on the DVI-SPLITPRO-4X is also compatible with HDMI. Please see the example of the cable above to use.

Note: Cable not included with packaging contents DVI to HDMI



2.4 DVI-SPLITPRO-4X I/O CONNECTORS

Avenview DVI-SPLITPRO-4X has 16 inputs and accepts both graphics and video signals, which come from computers (DVI or VGA), composite, and component video sources respectively. You can pick up four of the ten inputs and then display four of them simultaneously on the same screen.

CONNECTORS		VIDEO SOURCE
INPUT	DVI, COMPONENT, VGA, COMPOSITE, S-VIDEO	DVI
		HDMI (DVI to HDMI Cable or Adapter)*NOT SUPPLIED*
		VGA (DVI to VGA Adapter)
		Component (YPbPr) (DVI to VGA Adapter and VGA to Component Adapter)
		Composite
		S-Video
OUTPUT	DVI-I OUT	Display
		1 x DVI Display (1 x DVI/HDMI Display)
		VGA Display (DVI to VGA Adapter)
		1 x DVI Display & 1 x VGA Display (through DVI to DVI/VGA Y Cable)



DVI-SPLITPRO-4X

LAYOUT 1

MONITOR/TV
Preset layout 1

CABLE INDEX

- Output
- Input / Source
- RS-232



Preset Layout 2

1	2
3	4

Preset Layout 3

1		
2	3	4

Preset Layout 4

2	3	4
1		

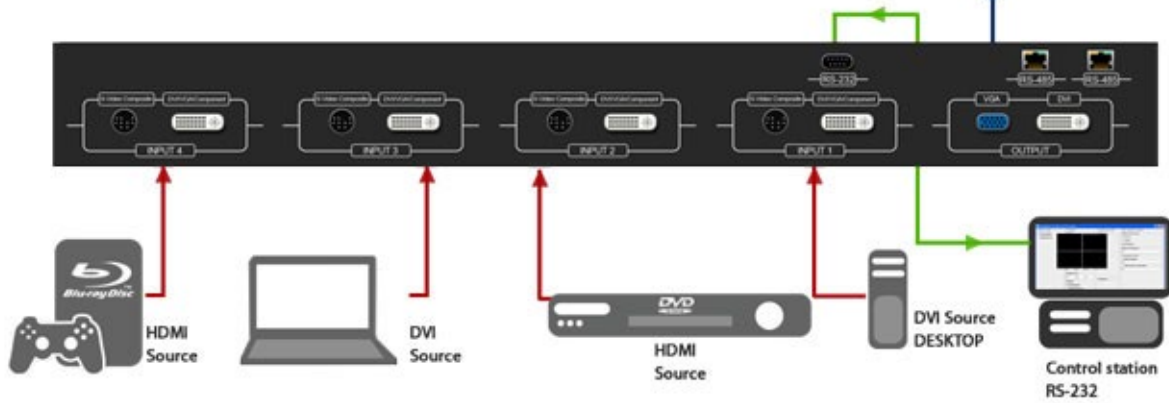

3. INSTALLATION

To setup Avenview DVI-SPLITPRO-4X follow these steps for connecting to a device:

1. Mount or fix the DVI-SPLITPRO-4X safely
2. Switch off DVI-SPLITPRO-4X and all source devices and displays that will be connected
3. Connect a monitor, projector, other displays that come with DVI / VGA inputs by using 1 male – male DVI cable to DVI-SPLITPRO-4X DVI output. (you can connect 2 displays equipped with DVI and VGA respectively by DVI – DVI/VGA Y cable
4. Plug-in DVI to DVI/VGA breakout cable to DVI-Component-VGA and plug in VGA to Component adapter to VGA connector of the breakout cable
5. Connect a device equipped with DVI output (such as PC) to the DVI connector of the breakout cable
6. Connect a device equipped with the component video output to 3-RCA jack of the Component video adapter
7. Connect a device with VGA output (such as laptop) to VGA connector of DVI-SPLITPRO-4X
8. Connected a device with Composite or S-Video video output to composite input of DVI-SPLITPRO-4X through S-Video / Composite Y cable.
9. Connect your computer to DVI-SPLITPRO-4X via RS232 cable and then install the software
10. Turn ON DVI-SPLITPRO-4X
11. Run the Control Software and establish the connection between PC and DVI-SPLITPRO-4X
12. Turn ON all connected devices and then control the display output thru RS232 and included software

4. SOFTWARE INSTALLATION

1. The DVI-SPLITPRO-4X provides a software control program which runs under Microsoft Windows 98, 2000, XP, Vista, 7 through the interface of RS-232 serial control.
2. Before you click on the icon of the software, make sure you have secured the connection between your computer COM port and the DVI-SPLITPRO-4X.
3. Install driver for RS232 to USB adapter
4. Once DVI-SPLITPRO-4X is turned on, it display green LED light

*Ensure that correct driver for RS232-USB Adapter (included with DVI-SPLITPRO-4X/K) is installed.
You can check "Device Manger" under "Ports" page to check if drivers are installed correctly.*



5. SOFTWARE SETUP GUIDE

1. Power up the DVI-SPLITPRO-4X and you can see VFD on the front panel blink.
2. Launch Avenview Control Software. It will open following “Serial Port” setting page.

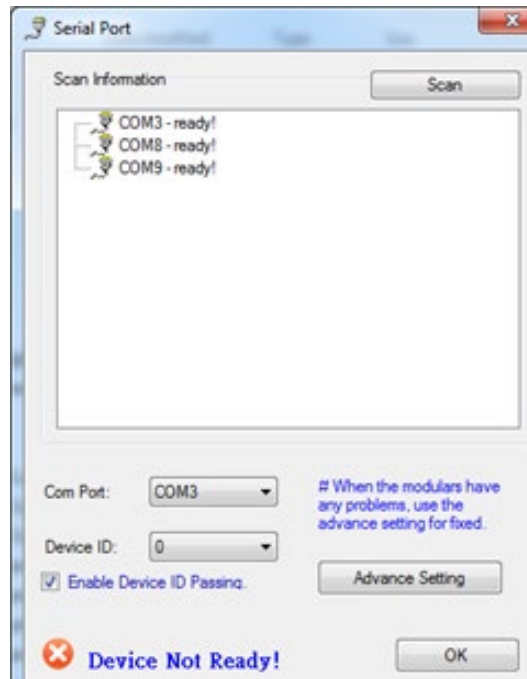

3. Click on Scan button and it will automatically detect Avenview Video Processor and display the following screen:

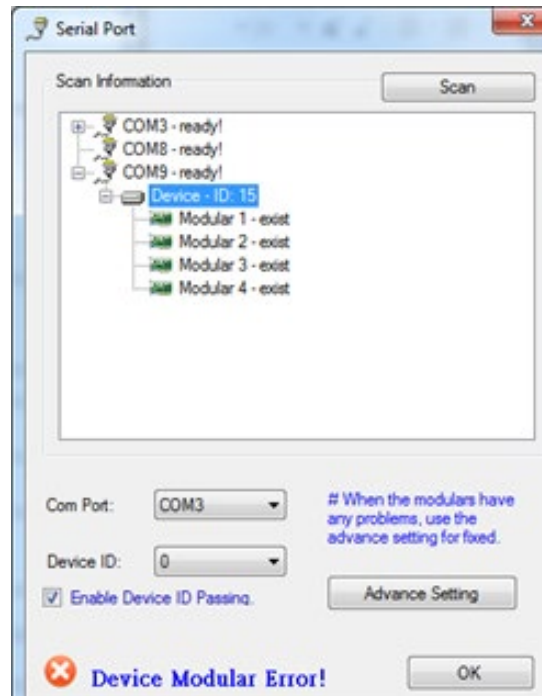

4. Note the “Device – ID” and Select Correct “Com Port” and Device ID” from bottom of screen. Once Correct “Com Port” and “Device ID” is selected, it will change “Device Modular Error” to “Device Ready” as shown below:



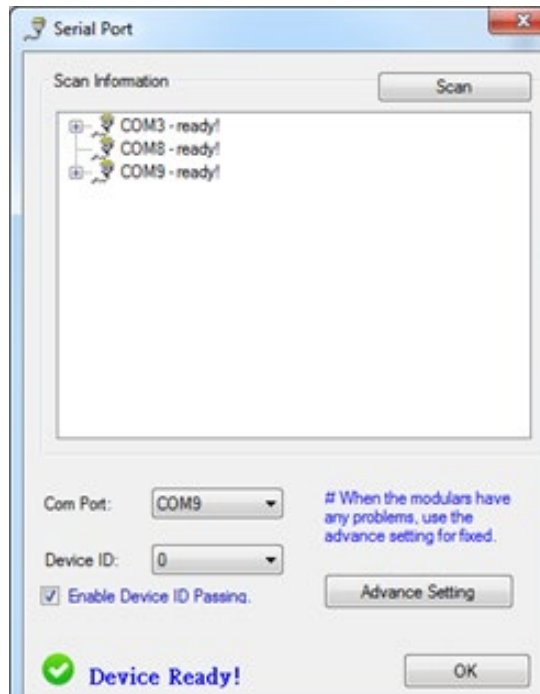

5. Once Device is Ready, click “OK” and Avenview Control Software will launch

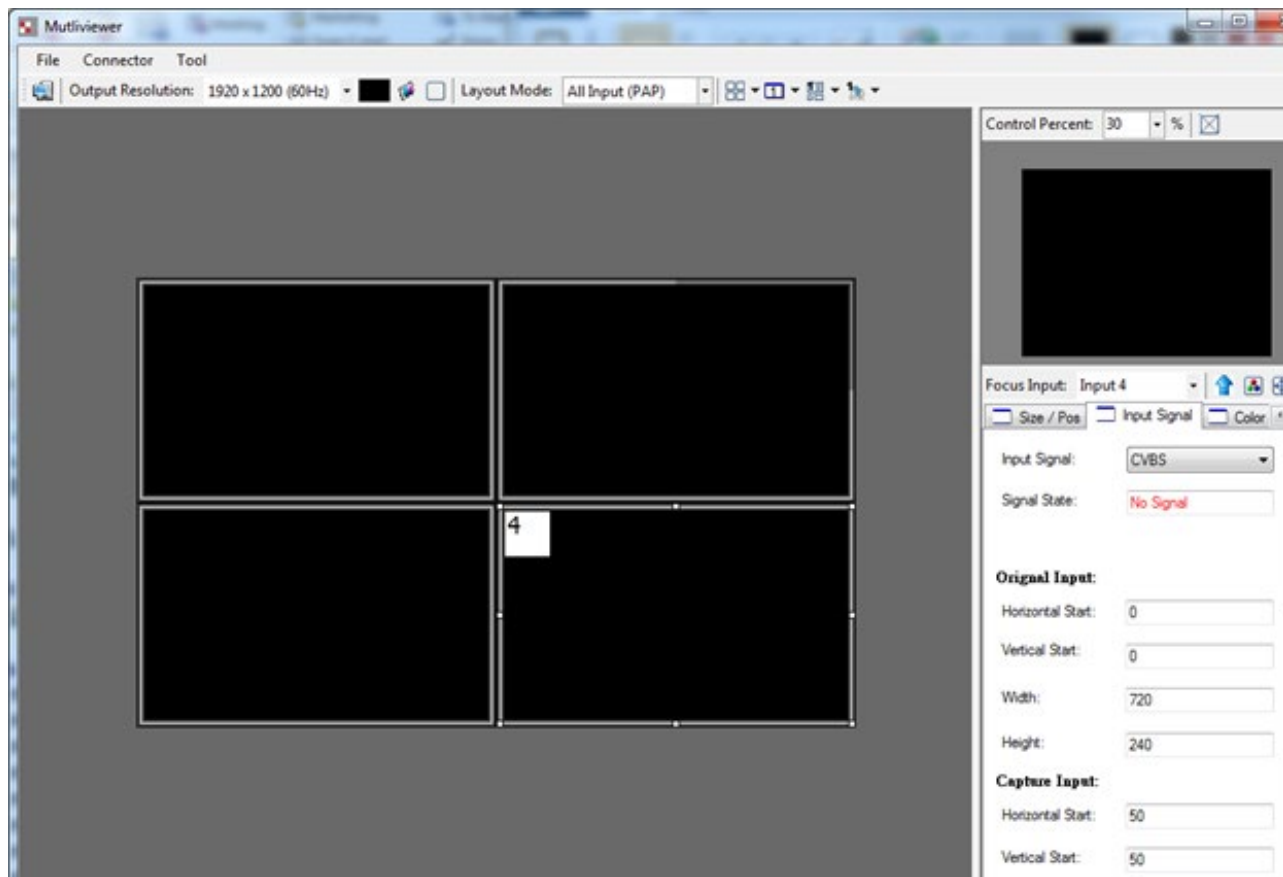

The software has following menu options available:



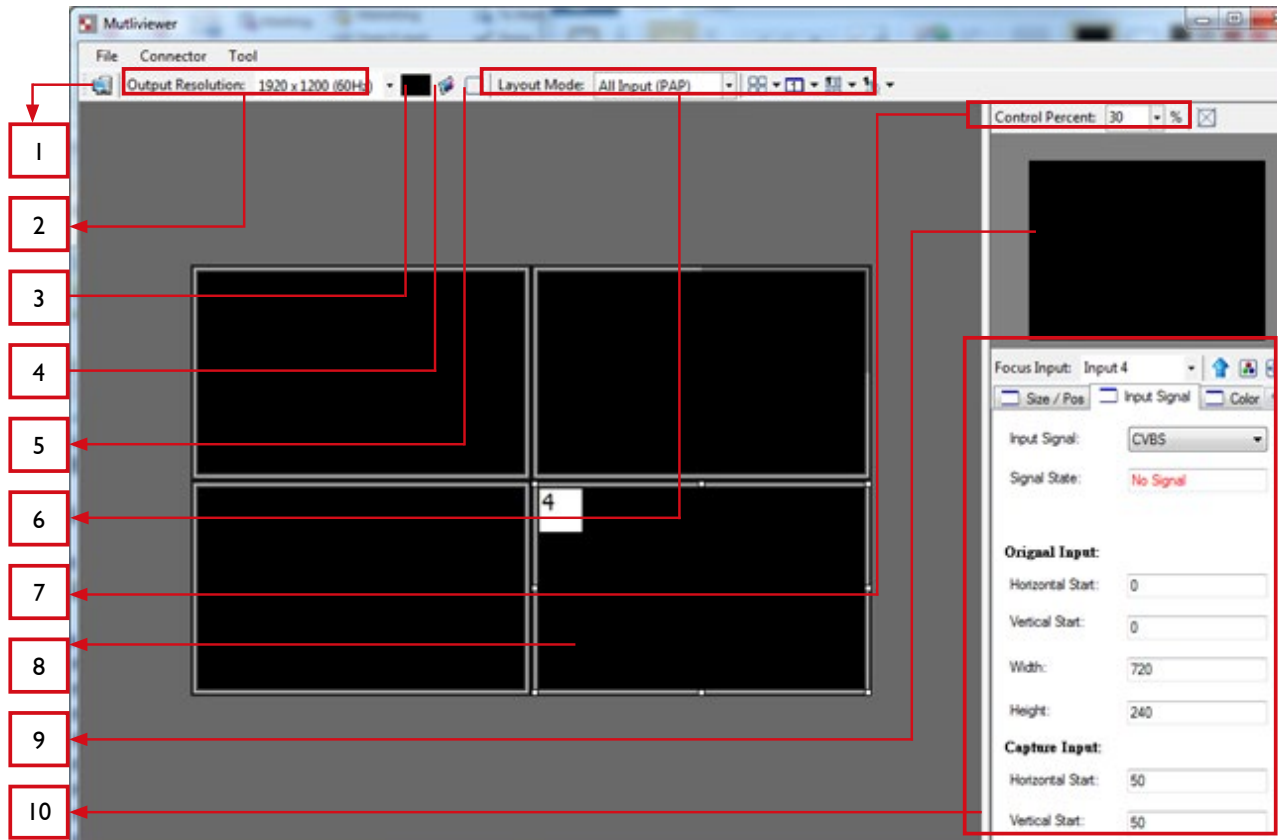

1 FAST LINKAGE

This button will update software GUI for device state

2 OUTPUT RESOLUTION

SUPPORTED MODE	RESOLUTION	SUPPORTED MODE	RESOLUTION
HDTV 720p	1280x720 @ 60Hz	VESA	1280x768 @ 60Hz
HDTV 1080p	1920x1080 @ 60Hz	VESA	1366x768 @ 60Hz
VESA	800x600 @ 60Hz	VESA	1400x1050 @ 60Hz
VESA	1024x768 @ 60Hz	VESA	1600x1200 @ 60Hz
VESA	1280x1024 @ 60Hz	VESA	1920x1200 @ 60Hz

3 BACKGROUND COLOR

Clicking on this button will show the color dialog for background color adjustment.

4 BACKGROUND SETTING

DVI-SPLITPRO-4X offers the video background to make this advanced unit actually working like 5 channel video mixer! The default background video must work as full screen! Users can choose between color and video background through the



following control window. Click on this button will show the dialog for output resolution, background color and background channel setting.

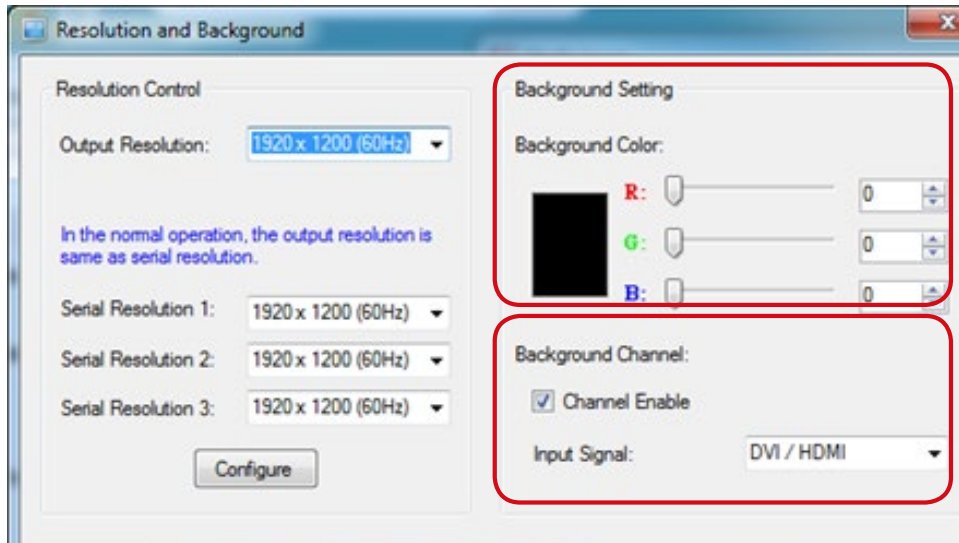

Note * We recommend not changing the Serial Resolutions.

**ONLY INPUT 4 CAN BE USED
AS “BACKGROUND CHANNEL”**

5 BORDER SETTINGS

Allows you to enable Border and enter Custom Text for Labels each Input Source.

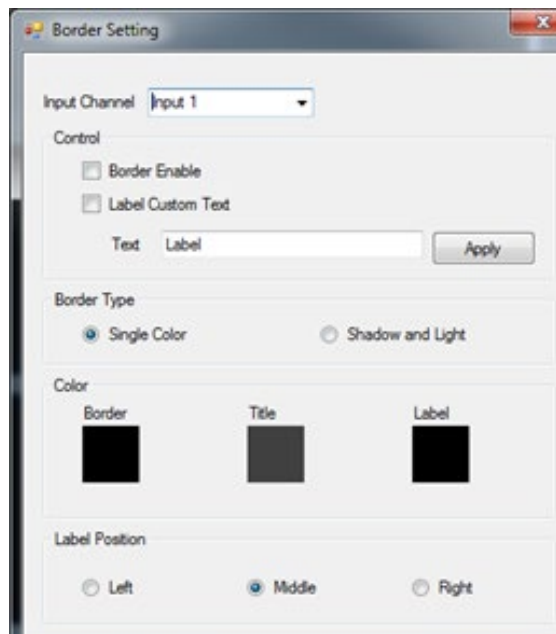

6 DISPLAY / LAYOUT MODE

Set signal channel full screen or all channel Notice that the input sources will not be changed in Software.



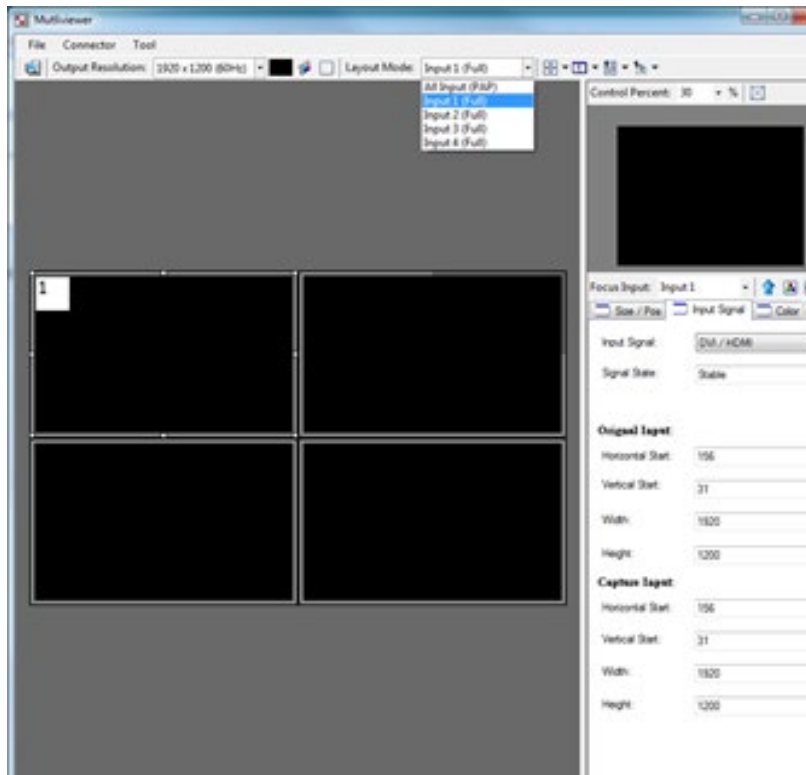

5.5 DEFAULT LAYOUTS

There are FIVE (5) pre-configured layouts available from Control Software, IR Remote Control or Front Panel Buttons.

- Panel Cross
- Panel Right – Type
- Panel Left – Type
- Panel Top – Type
- Panel Bottom – Type

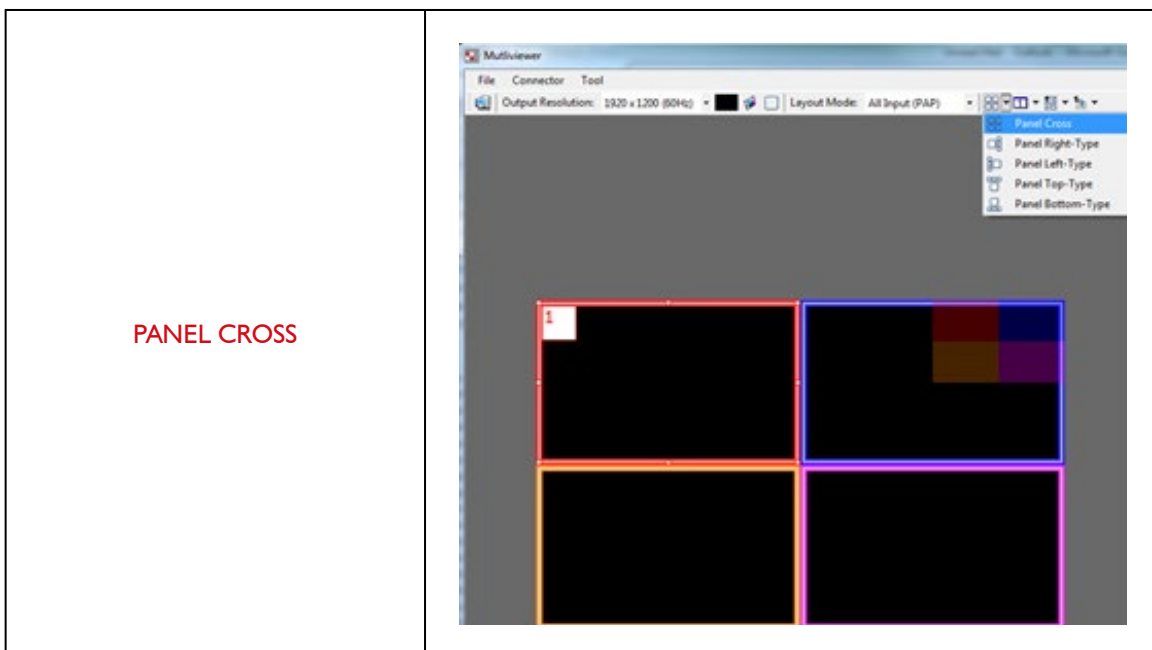

PANEL RIGHT – TYPE

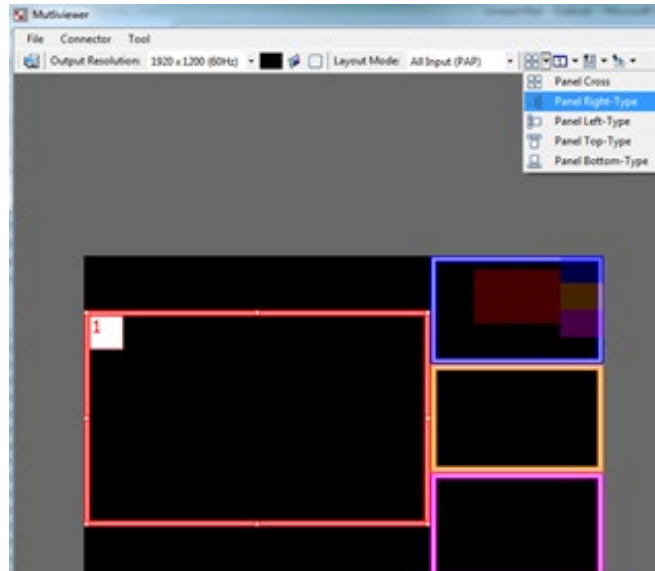

PANEL LEFT – TYPE

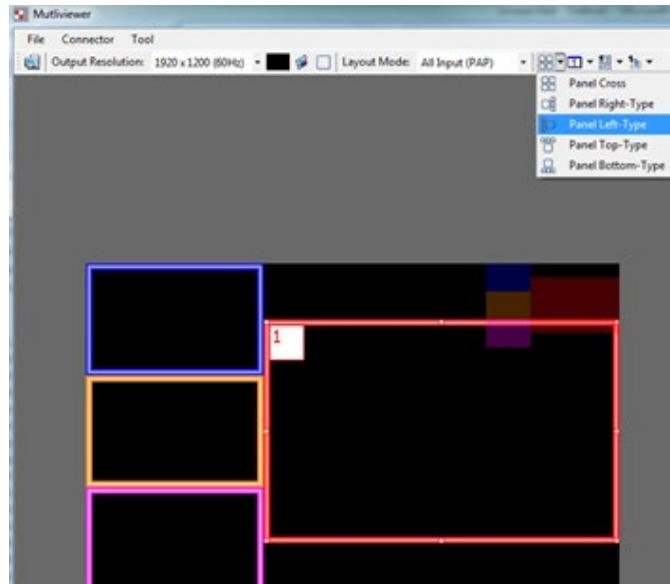

PANEL TOP – TYPE

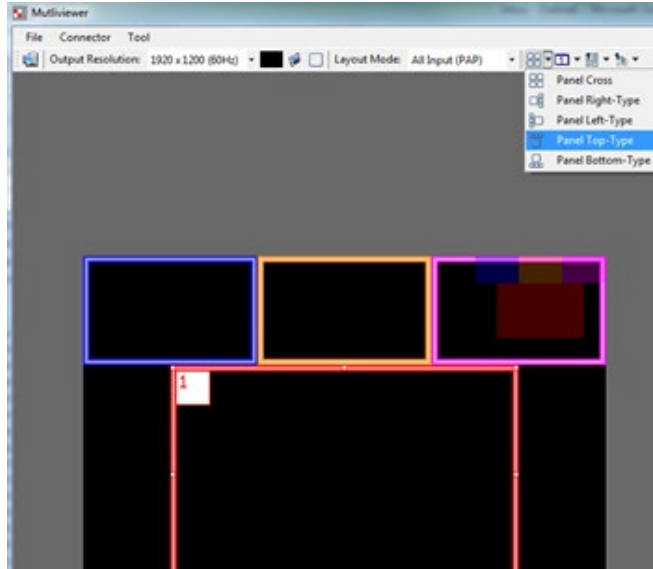

PANEL BOTTOM – TYPE

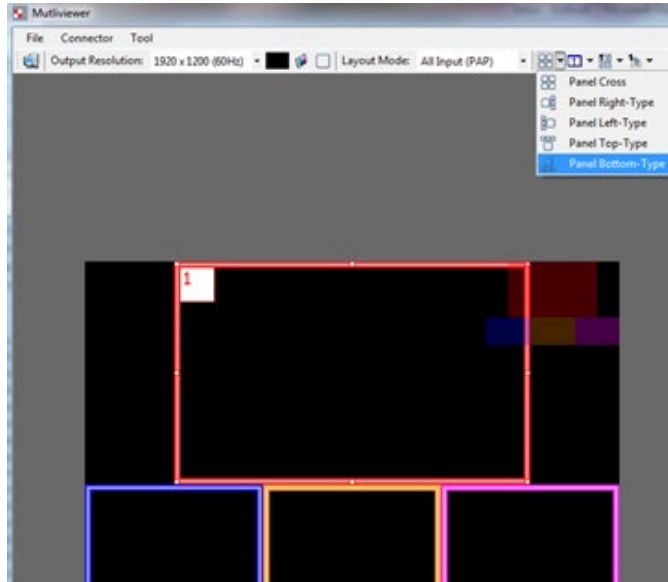

Input Signal which is selected at "Focus Input" will be displayed as Main Video Sources.



5.6 FOCUS INPUT

Select which Input Source should stay in focus when “Layouts” are selected

5.7 SAVE AND SET CUSTOM LAYOUTS

Save up to 8 Custom Layouts and Set them using Control Software, Front Panel or IR Remote Control.

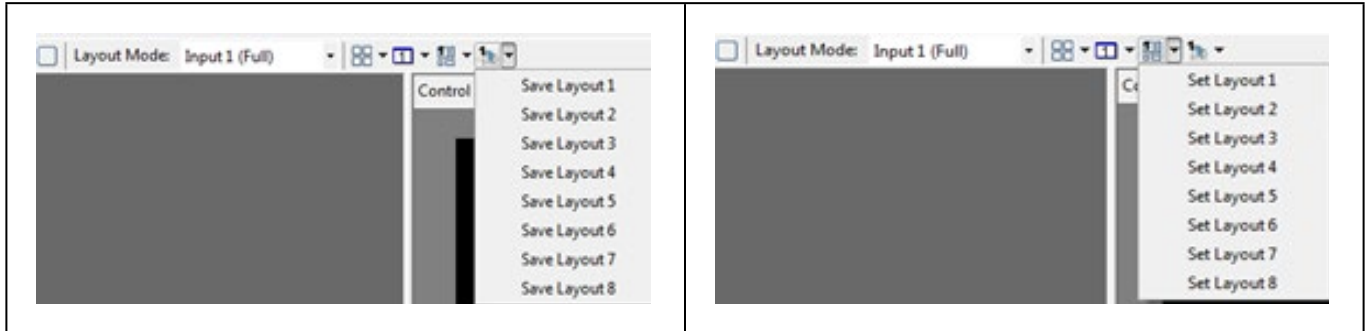

7 LAYOUT CONTROL SIZE

Set layout control size in Software by percent.

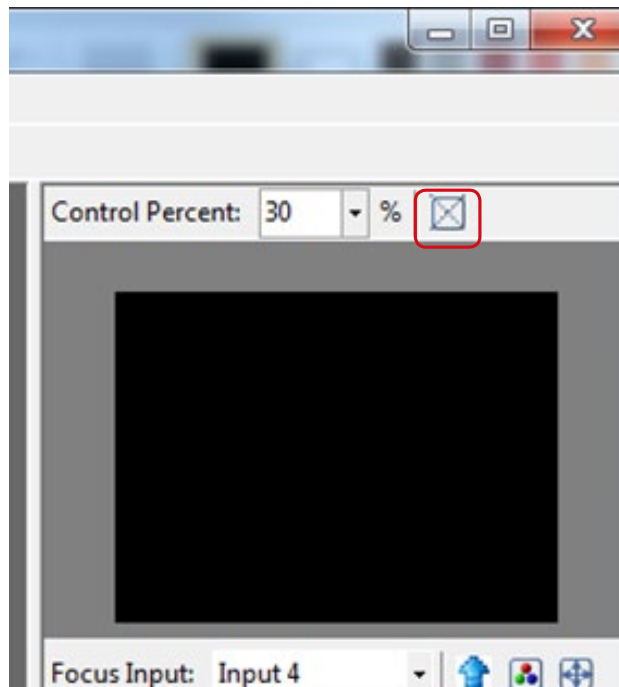

If you enable Fixed Stretch, Aspect Ratios are kept with each Input layout is changed.

8 LAYOUT CONTROL

Create different Layouts by Drag and Drop. You can use “Fixed Aspect Ratio” as described above to retain Aspect Ratio of source image.



9

PREVIEW WINDOW

Shows preview Window of Layouts

10

INPUT CHANNEL SELECTION AND CUSTOMIZATION

In this section you can Select Input Channel, Input Signal, Channel Window Visible, Blend Settings, Custom Height, Custom Width, Color Brightness, Contrast, Saturation, Hue, Red, Green, Blue, Color Balance and Auto Configuration.

5.8 INPUT SELECTION:

- Select "Focus Input" from drop down menu or by Clicking on Main Layout Window.
- Click on "Input Signal".
- Select Correct "Input Signal" from drop down menu.
- Once right Input Signal is selected, click on UP ARROW (Input Update) beside Focus Input to update it on system memory.

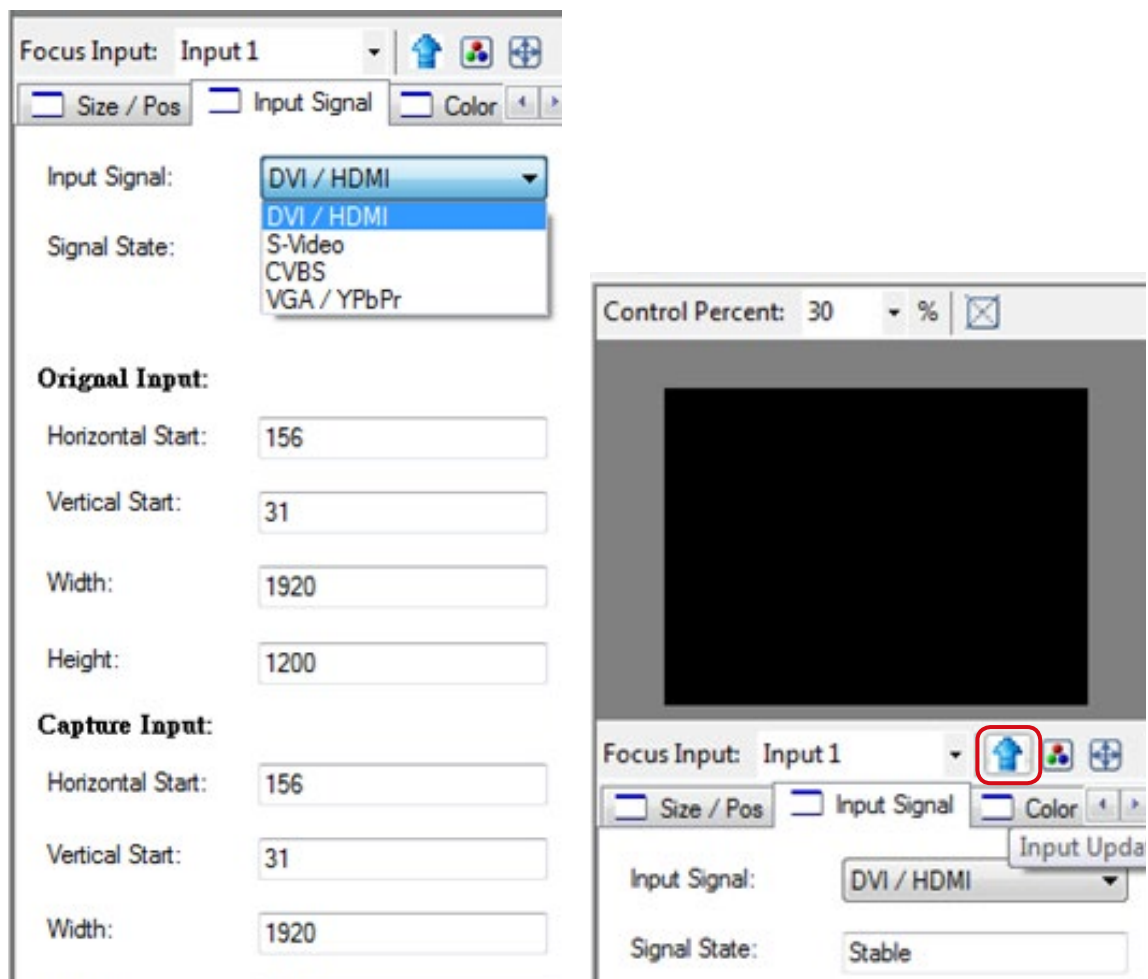

5.9 SIZE AND POSITION:

Select on “Size / Pos”

CHANNEL WINDOWS VISIBLE: You may uncheck “Channel Window Visible” if you decide to not show this Windows on screen

BLEND: Change the value of Blending from 100% to 0%. This will allow you to overlay an Input Source on other.

CUSTOM HEIGHT AND WIDTH: If you have specific requirement for Input Layout, you may adjust them here.

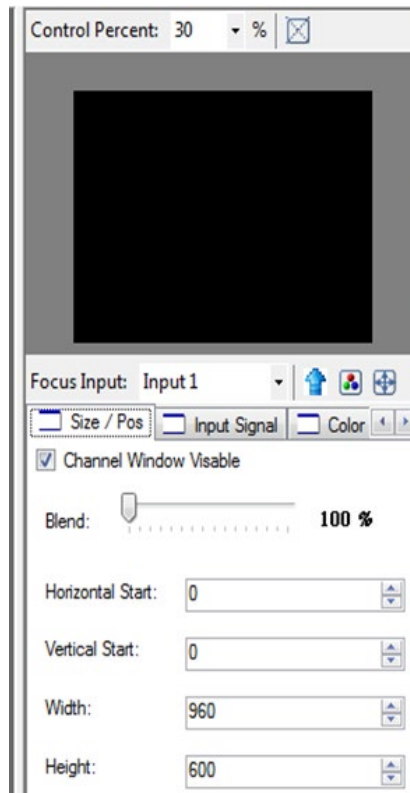

5.10 COLOR SETTING:

Various options to change Brightness, Contrast, Saturation, Hue, Red, Green and Blue are available on each “Input Source”

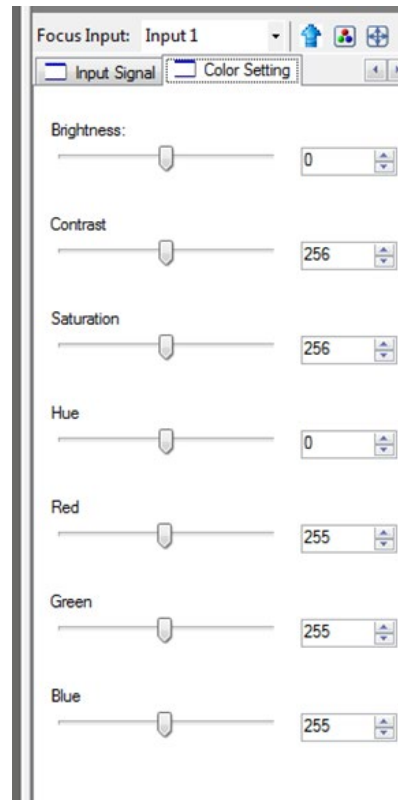

5.10.1 COLOR BALANCE AND AUTO CONFIGURE:

You may adjust Color Balance and Auto Configure them by selecting these options

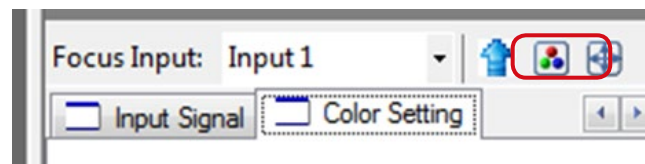





6. SOFTWARE CONFIGURATION

Follow these steps to select right Output Resolution and Input Signal

- Once RS232 communication is setup properly, you should select Optimal “OUTPUT Resolution” supported by your Display (TV or Monitor)
- Select correct “Input Signal” for each Input.
- After Selecting right Input Signal, ensure to Click on “Input Update” (BLUE Arrow)
- Repeat above steps for each Input you have connected
- Select Layout Mode
- Select “Default Layouts” or create your own by dragging dropping

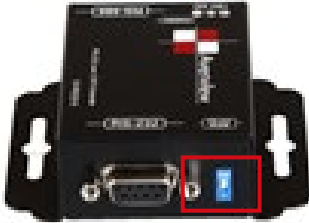

7. CASCADE INSTALLATION

PRODUCT	SETTINGS
	<p>The device id number will show on the vfd, like below picture</p>
	<p>The "device id" number can adjust by button menu.</p> <ol style="list-style-type: none"> 1. Please push the "down, up, left, right" button, 2. Enter menu → "(05/05) system 3. Setting" menu → "(03/03) device id" menu.
	<p>Push the "right" button. When the "up" and "down" arrow are display, you can adjust number by "up" and "down" button.</p>
	<p>Set the dip switch on the c5-rs232-s to the on position As illustrated in picture</p>
	<p>Set the dip switch on the dvi-splitpro-4x to # 1 off (up) #2 on (down) As illustrated in picture</p>
	<p>When set dvi-splitpro-4x to rs485 mode by "dip switch". Please check the vfd will display "square" icon</p>



MODEL NAME		C5-RS232-S
ROLE OF USAGE		TRANSMITTER [TX]
TRANSMISSION LENGTH		UP TO 1,000M (1,100YD) [CAT5E]
BAUD RATE		UP TO 57.6KBPS IN CASCADE MODE
INPUT		1X RS-232
OUTPUT		1X RJ-45
RS-232 CONNECTOR		DE-9 [9-PIN D-SUB FEMALE]
RJ-45 CONNECTOR		WE/SS 8P8C WITH 2 LED INDICATORS
DIP SWITCH		6-PIND & AUDIO MODE [SW MAIN] 6-PIN OPERATION & FIRMWARE UPDATE
MECHANICAL		C5-RS232-S
HOUSING		METAL CASE
DIMENSIONS [L X W X H]	MODEL	TBA
	PACKAGE	270 X 175 X 80MM [10.6" X 6.9" X 3.1"]
	CARTON	450 X 370 X 300MM [1'6" X 1'3" X 11.8"]
WEIGHT	MODEL	TBA
	PACKAGE	TBA
FIXEDNESS		WALL-MOUNTING CASE UPON REQUEST
POWER SUPPLY		5V 2A DC
POWER CONSUMPTION		1 WATT [MAX]
OPERATION TEMPERATURE		0~40°C [32~104°F]
STORAGE TEMPERATURE		-20~60°C [-4~140°F]
RELATIVE HUMIDITY		20~90% RH [NO CONDENSATION]
PACKAGE CONTENTS		1X C5-RS232-S 2X 5V POWER ADAPTER 1X USER MANUAL



* Using C5-RS232-S to control all the cascaded DVI-SPLITPRO-4X

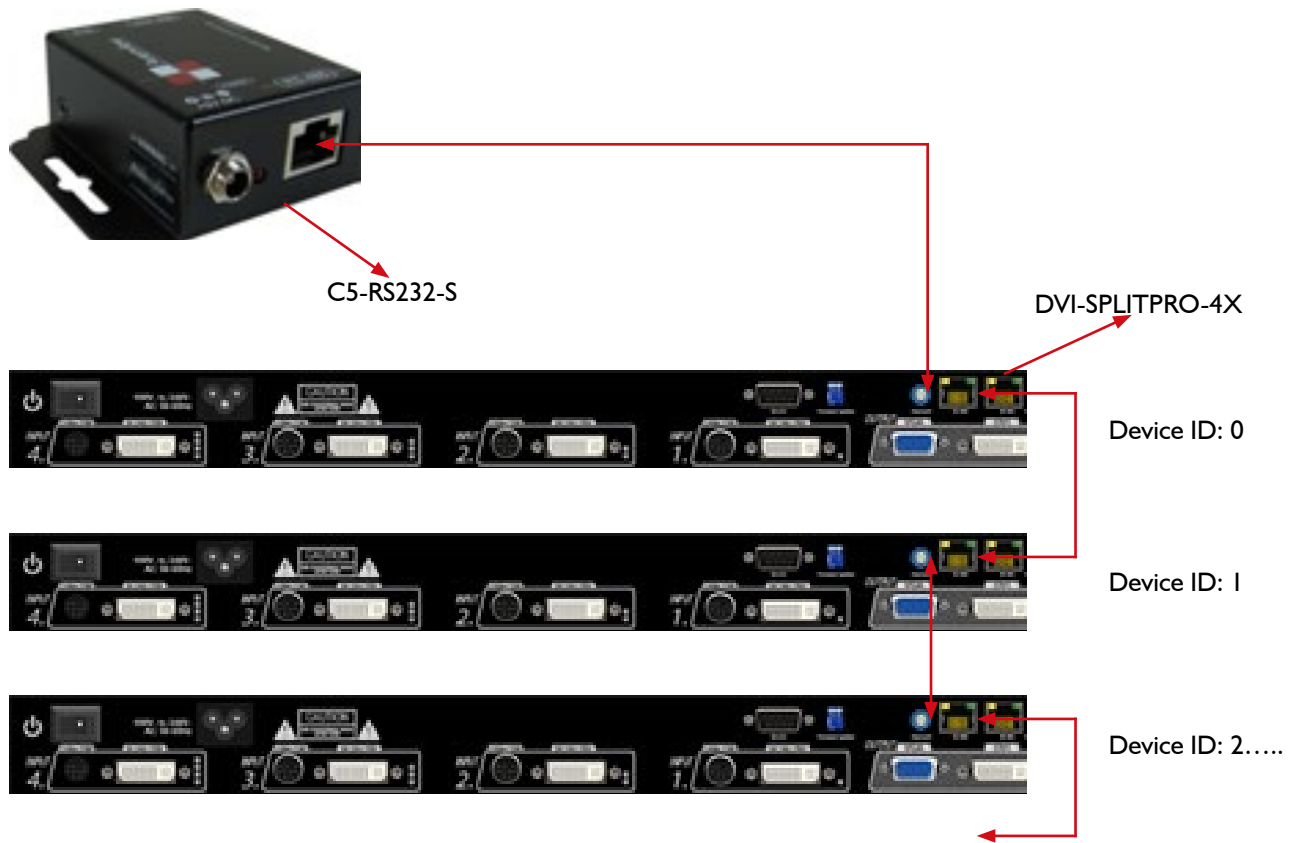

(3) Cascading DVI-SPLITPRO-4X



- a. Display to connected DVI-SPLITPRO-4X (1) DVI output
- b. DVI input 4 to connected DVI-SPLITPRO-4X (2) DVI output.
- c. Others are cascaded by this way.



8. FRONT PANEL CONTROLS

8.1 FRONT PANEL PUSH BUTTONS DESCRIPTION

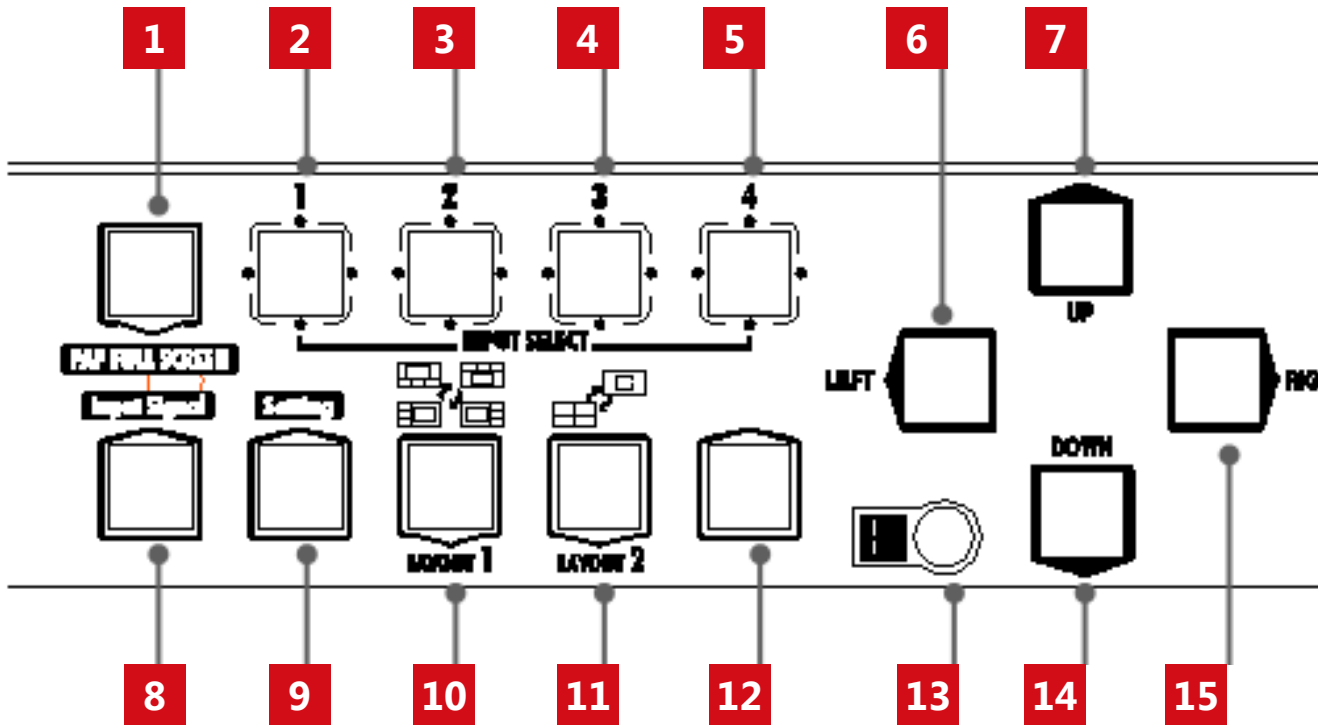

1	PAP Full Screen	11	Function key: Layout 2
2 3 4 5	Input Select	12	N/A
8	Function key: Input Signal	13	Infrared Sensor
9	Function key: Setting	6 7 14 15	Navigation
10	Function key: Layout 1		

8.2 FRONT PANEL PUSH BUTTONS FUNCTIONS

8.3 SELECTING PIP WINDOW ARRANGEMENT

MAIN WINDOW WITH 3 TRIPLE SUB-WINDOWS ASIDE

You may choose one of the following layouts from 4 presets:

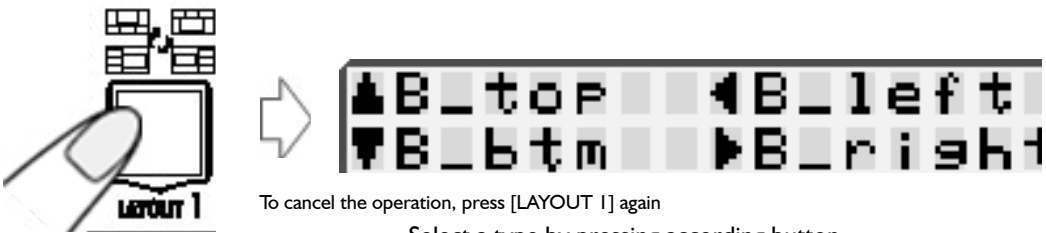
1. 

To cancel the operation, press [LAYOUT 1] again

Select a type by pressing according button while VFD

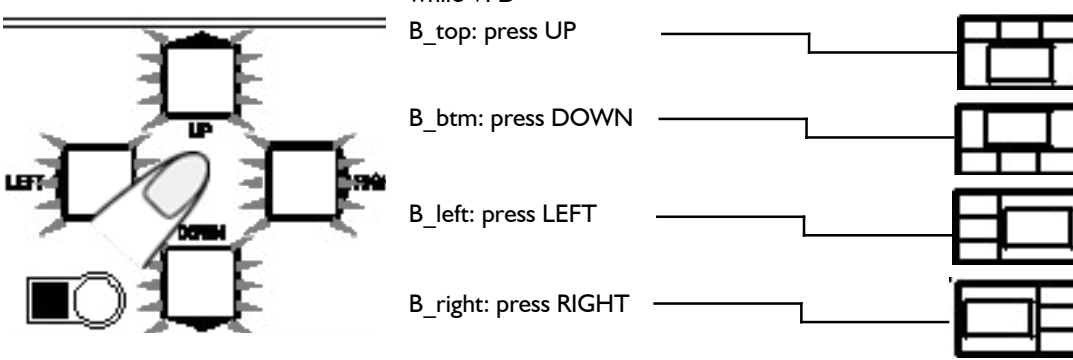
2. 

B_top: press UP

B_btm: press DOWN

B_left: press LEFT

B_right: press RIGHT

QUAD WINDOWS IN CRISSCROSS + 3 USER-DEFINED CUSTOM LAYOUTS

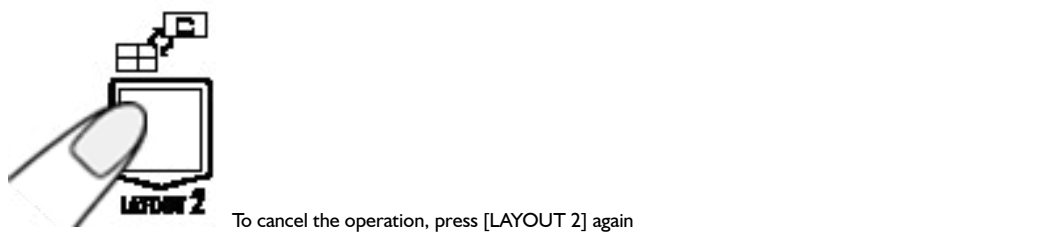
1. 

To cancel the operation, press [LAYOUT 2] again

Select a type by pressing according button while VFD

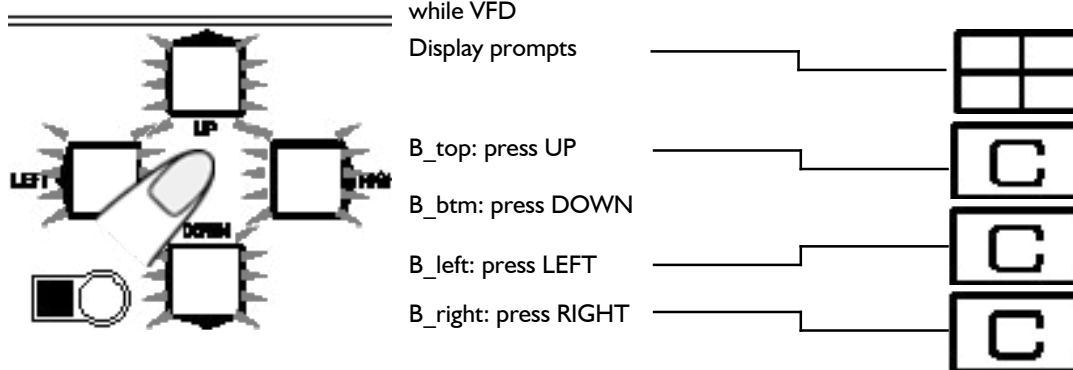
2. 

Display prompts

B_top: press UP

B_btm: press DOWN

B_left: press LEFT

B_right: press RIGHT



9. ON SCREEN DISPLAY MENU TREE

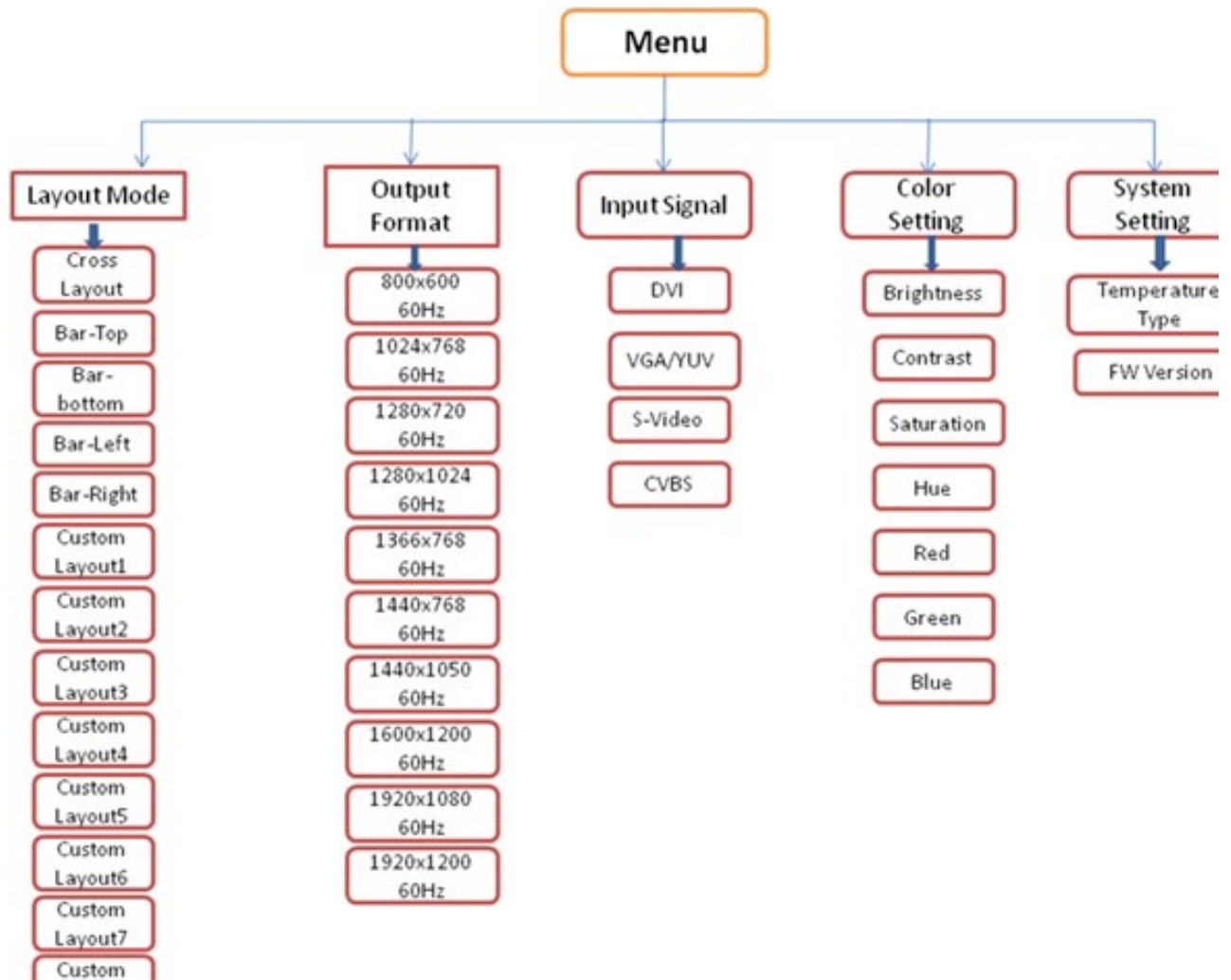

10. IR REMOTE CONTROL

Avenview DVI-SPLITPRO-4X, Advanced Quad Screen Processor ships with a compact IR Remote Control that allows for direct access to most commands used to control the video processor.

IR REMOTE BUTTON DEFINE	
1. POWER BUTTON	Set the output video into Sleep Mode (No Video)
2. CROSS-LAYOUT	Set PAP layout to default layout (cross type)
3. SIDE-BAR LAYOUT	Set PAP layout to default layout (Side-Bar type)
4. IN 2 (INPUT CHANNEL 2)	First Press Set channel 2 to be focus channel Second Press enables Channel 2 Full Screen
5. RIGHT BUTTON	Enables Menu Options and Also Select Button in Menu Options
6. IN 4 (INPUT CHANNEL 4)	Set channel 4 to be focus channel Second Press enables Channel 4 Full Screen
7. UP BUTTON	Move Up in Menu settings
8. PAP FULL SCREEN	Move to the left titles
9. DOWN BUTTON	Move Down in Menu settings
10. IN 1 (INPUT CHANNEL 1)	Set channel 1 to be focus channel Second Press enables Channel 1 Full Screen
11. LEFT BUTTON	Previous in Menu settings
12. IN 3 (INPUT CHANNEL 3)	Set channel 3 to be focus channel Second Press enables Channel 3 Full Screen
13. CUSTOM LAYOUT4	Set PAP layout to custom position and size
14. CUSTOM LAYOUT8	Set PAP layout to custom position and size
15. CUSTOM LAYOUT3	Set PAP layout to custom position and size
16. CUSTOM LAYOUT7	Set PAP layout to custom position and size
17. CUSTOM LAYOUT2	Set PAP layout to custom position and size
18. CUSTOM LAYOUT6	Set PAP layout to custom position and size
19. CUSTOM LAYOUT1	Set PAP layout to custom position and size
20. CUSTOM LAYOUT5	Set PAP layout to custom position and size
21. CH4 SOURCE	Toggle between channel 4 input source DVI/HDMI, VGA/Y-Pb-Pr, S-VIDEO, CVBS
22. CH3 SOURCE	Toggle between channel 3 input source DVI/HDMI, VGA/Y-Pb-Pr, S-VIDEO, CVBS
23. CH2 SOURCE	Toggle between channel 2 input source DVI/HDMI, VGA/Y-Pb-Pr, S-VIDEO, CVBS
24. CH1 SOURCE	Toggle between channel 1 input source DVI/HDMI, VGA/Y-Pb-Pr, S-VIDEO, CVBS
25. D BUTTON	Reserve
26. C BUTTON	Reserve
27. B BUTTON	Reserve
28. A BUTTON	Reserve

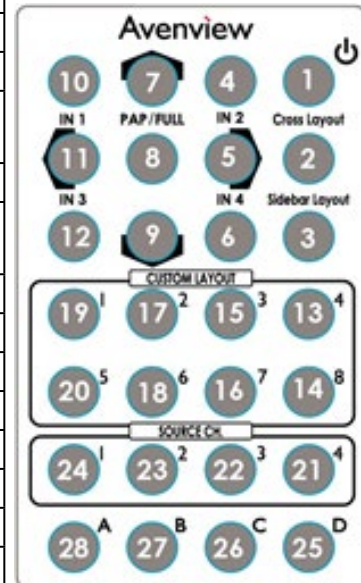

11. SPECIFICATIONS

MODEL	DVI-SPLITPRO-4X
DESCRIPTION	Advanced Quad Screen Video Processor with Front Panel and IR Control
DUAL OUTPUT SUPPORT	Yes (DVI & VGA)
BACKGROUND VIDEO INPUT	Yes
HDCP COMPLIANCE	Yes
VIDEO BANDWIDTH	DVI/HDMI Single Link - 4.95Gbps
	VGA - 165 MHz
	Component - 30 MHz
	S-Video – 13.5 MHz
	Composite – 13.5 MHz
SUPPORTED RESOLUTIONS	480i / 480p / 720p / 1080i / 1080p (60) / 1920x1200@75 / 1600x1200@60
AUDIO SUPPORT	No
CONTROL	RS232 / RS485
EMBEDDED VIDEO MIXER	Yes
ABILITY TO CASCADE	Yes
INPUT TMDS SIGNAL	1.2 Volts (peak – peak)
ESD PROTECTION	Human body model - ± 15 kV (air gap discharge) & ± 8 kV (contact discharge)
INPUT	4 x VGA (through included DVI to VGA Adapter)
	4 x DVI
	4 x HDMI (through HDMI to DVI Cable / Adapter, not supplied)
	4 x Component (through included adapter)
	4 x Composite (through included cable)
	4 x S-Video (through included cable)
	1 x RS232
	1 x RS485
OUTPUT	1 x DVI (Also supports HDMI signal by DVI to HDMI Cable) 1 x VGA
DVI CONNECTOR TYPE	DVI-I (29-Pin female)
VGA CONNECTOR TYPE	HD-15 (15-pin D-sub female)
S-VIDEO CONNECTOR	9 Pin
RS232 CONNECTOR	DE-9 (9-pin D-sub female)
RCA CONNECTOR	75 Ω
RJ45 CONNECTOR	WE/SS 8P8C with 2 LED indicators
DIMENSIONS	11.8" x 15.3" x 1.7" (L x W x H)
SIZE	1U Rack-mount with ears
POWER SUPPLY	AC 100-240V
POWER CONSUMPTION	35 Watts (max)
OPERATING TEMPERATURE	0~40°C [32~104°F]
STORAGE TEMPERATURE	-20~60°C [-4~140°F]
RELATIVE HUMIDITY	20~90% RH [no condensation]



12. RESOLUTIONS COMPATIBILITY

12.1 DVI / COMPONENT / VGA

SUPPORTED MODE	RESOLUTION
NTSC/480i/525i	720x240 @60Hz
PAL/576i/625i	720x288 @50Hz
480p/525p	720x483 @60Hz
480p (16:9)	960x483 @60Hz
576p/625p	720x756 @50Hz
(HDTV) 720p	1280x720 @50Hz
(HDTV) 720p	1280x720 @60Hz
(HDTV) 1080i	1920x1080 @50Hz
(HDTV) 1080i	1920x1080 @60Hz
(HDTV) 1080p	1920x1080 @30Hz
VESA	720x400 @85Hz
VESA	640x350 @85Hz
VESA	640x400 @85Hz
IBM	720x400 @70Hz
IBM	720x350 @70Hz
IBM	640x350 @70Hz
IBM	640x400 @70Hz
VESA	640x480 @60Hz
MAC	640x480 @67Hz
VESA	640x480 @72Hz
VESA	640x480 @75Hz
VESA	640x480 @85Hz
VESA	800x600 @56Hz
VESA	800x600 @60Hz
VESA	800x600 @72Hz

SUPPORTED MODE	RESOLUTION
VESA	800x600 @75Hz
VESA	800x600 @85Hz
MAC	832x624 @75Hz
VESA	1024x768 @60Hz
MAC	1024x768 @60Hz
VESA	1024x768 @70Hz
IBM	1024x768 @72Hz
VESA	1024x768 @75Hz
MAC	1024x768 @75Hz
VESA	1024x768 @85Hz
VESA	1152x864 @75Hz
MAC	1152x870 @75Hz
SUN	1152x900 @66Hz
SUN	1152x900 @76Hz
VESA	1280x960 @60Hz
VESA	1280x960 @85Hz
VESA	1280x1024 @60Hz
HP	1280x1024 @60Hz
IBM	1280x1024 @67Hz
HP	1280x1024 @72Hz
VESA	1280x1024 @75Hz
SUN	1280x1024 @76Hz
VESA	1600x1200 @60Hz
VESA	1920x1200 @60Hz

12.2 DVI-OUT

SUPPORTED MODE	RESOLUTION	SUPPORTED MODE	RESOLUTION
(HDTV) 720p	1280x720 @50Hz	VESA	1366x768 @60Hz
(HDTV) 720p	1280x720 @60Hz	VESA	1400x1050 @60Hz
(HDTV) 1080p	1920x1080 @60Hz	VESA	1400x1050 @50Hz
VESA	640x480 @60Hz	VESA	1152x864 @75Hz
VESA	800x600 @60Hz	VESA	1600x1200 @60Hz
VESA	1024x768 @60Hz	VESA	1920x1200 @50Hz
VESA	1152x864 @75Hz	VESA	1920x1200 @60Hz
VESA	1280x1024 @60Hz		



13. GENERAL TROUBLESHOOTING

PROBLEM	POSSIBLE SOLUTION
NO POWER	<ul style="list-style-type: none"> • Ensure that DVI-SPLITPRO-4X is plugged in • If you are recovering from power outage, accidentally unplug the adapter or other power surge conditions, leave the device off for an at least a minute and then power it on again.
NO OR DISTORTED IMAGE	<ul style="list-style-type: none"> • Make sure all cables are in good working condition and properly connected to the DVI-SPLITPRO-4X and displays. • Configure the output video resolution so that it doesn't exceed the native resolution of the display. (in this case, the message of "out of range" is usually showed on your screen)
POOR QUALITY	<ul style="list-style-type: none"> • We suggest that don't use T-connectors to split your video source into to images displayed on two different screens. That will lower output video quality. Use a distribution amplifier instead of T-connectors. • Make sure the video source is not compressed and maintains the highest native resolution.
WRONG COLOR	<ul style="list-style-type: none"> • Press "Color Balance" key for auto configuration. Auto color configuration only works at VGA and Component inputs.
NO VIDEO AFTER FACTORY HARDWARE AND SOFTWARE RESET	<ul style="list-style-type: none"> • Always perform a hard power reset from the back of the unit using the power switch on back right. • In the configuration software after the factory reset navigate to: <ul style="list-style-type: none"> ➤ Advance setting button ➤ Ensure the correct COM Port is enabled ➤ Wait until Green check mark and Device Ready! is complete ➤ Proceed to "Device Setting/Testing" "Execute Selector" ➤ Select "Modular Configure" then Press Execute Button





AV Connectivity, Distribution And Beyond...

TECHNICAL SUPPORT

CONTACT US



Phone: 1 (866) 508 0269



Email: support@avenview.com



USA Head Office Avenview Corp. 275 Woodward Avenue Kenmore, NY 14217

Disclaimer

While every precaution has been taken in the preparation of this document, Avenview Inc. assumes no liability with respect to the operation or use of Avenview hardware, software or other products and documentation described herein, for any act or omission of Avenview concerning such products or this documentation, for any interruption of service, loss or interruption of business, loss of anticipatory profits, or for punitive, incidental or consequential damages in connection with the furnishing, performance, or use of the Avenview hardware, software, or other products and documentation provided herein.

Avenview Inc. reserves the right to make changes without further notice to a product or system described herein to improve reliability, function or design. With respect to Avenview products which this document relates, Avenview disclaims all express or implied warranties regarding such products, including but not limited to, the implied warranties of merchantability, fitness for a particular purpose, and non-infringement.