

EVID FM4.2

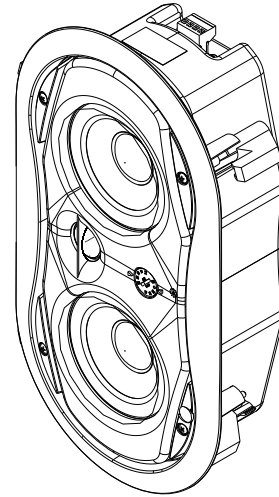

Electro-Voice

- 4 inch two-way system with polypropylene diaphragm for reliable long-term operation
- Extremely compact depth fits into tight spaces including walls and tight ceiling spaces
- Titanium coated tweeter gives even uniform high frequency coverage
- Front baffle wattage tap adjustment allows for easy level matching after installation
- Integrated low loss matching transformer allows for either 70v/100v or 8 ohm operation



The EVID FM4.2 flush-mounted loudspeaker system from Electro-Voice is a complete two-way in-wall loudspeaker package. The package consists of a bezel assembly, grille, rear enclosure, 4 inch two-way loudspeaker coupled with a 4 inch passive radiator and an internal line-matching transformer. The loudspeaker features 4 inch low-frequency cone and high-temperature voice-coil assembly along with a 4 inch long excursion passive radiator and titanium coated dome tweeter. The EVID FM4.2 loudspeaker utilizes a crossover network, centered at 3,600 Hz, that provides 16-dB-per-octave tweeter protection outside of its operating range. In addition the EVID FM4.2 features a comprehensive protection circuit to shield the woofer and tweeter drivers from excessive power levels.

The EVID FM4.2 utilizes a transformer that offers a selection of 1.75, 3.75, 7.5, 15 or 30 watts delivered to the loudspeaker system using either 70-V or 100-V lines. The wattage is selected via a convenient switch on the front baffle. The unit can also be operated as an 8-ohm speaker via the same front panel selector switch.

The perforated grille is finished in semi-gloss white powder-coated enamel. The baffle and bezel is constructed from heat resistant ABS. The rear enclosure is constructed from zinc-plated, steel. The rear enclosure provides an optimum internal volume, ensuring extended low-frequency performance. It is constructed from heavy-gauge, rugged steel. The steel rear enclosure was optimized using FEA to virtually eliminate panel resonance. The entire enclosure is less

than 4 inch deep providing an easy installation into nearly any tight wall or ceiling space. A rear cover, with provisions for a junction box fitting, provides access to a 4-pin terminal block that allows direct connection to the speaker and provides pass through to additional speakers. FM4.2 loudspeakers provide wide dispersion, high-efficiency, high-maximum output, ease of installation, and wide-range reproduction of music or voice.

Technical specifications

Frequency Response (-3 dB):	70 Hz - 20 kHz
Frequency Range (-10 dB):	52 Hz - 20 kHz
Sensitivity:	87 dB (SPL 1W/1m)
Maximum SPL:	110 dB
Coverage:	150° ¹
Impedance:	8 ohms nominal (transformer bypass)
Crossover Frequency:	3.6 kHz
Rec. Highpass Frequency:	70 Hz
Power Handling:	50W Cont. Prog. / 200W Peak ²
HF Transducer:	1 in (25.4 mm)
LF Transducer:	4 in (101.6 mm) Passive Radiator: 4 in. (101.6 mm)

Transformer Taps:	70V: 1.75, 3.75, 7.5, 15, or 30W 100V: 3.75, 7.5, 15, or 30W Bypass: 8 ohms nominal
Connectors:	4 pin phoenix style terminals
Enclosure Material:	Baffle: UL 94V-0 rated ABS Backcan: Zinc plated steel
Color:	White
Grille:	Perforated powdercoated steel with safety tether
Mounting System:	Integrated toggle anchors
Support Hardware:	Cutout template, Paint Shield
Dimensions:	349.9 mm x 188.3 mm x 96.5 mm (13.77 in x 7.42 in x 3.80 in)
Net Weight (Each):	2.9 kg (6.5 lb)
Shipping Weight (Pair):	6.8 kg (15.0 lb)

¹Measured on an IEC Baffle. Symmetric coverage angle.

²Continuous Program Rating: 3 dB greater than continuous pink noise rating (IEC-shaped pink noise with 6 dB crest factor)



Notice!

All specifications based on Half-Space Environment as flush-mounted.

Architectural and engineering specifications:

The EVID FM4.2 loudspeaker system shall be comprised of a baffle/bezel assembly, front grille, rear enclosure, transformer, 4 inch passive radiator, and 4 inch loudspeaker. The loudspeaker will feature a 4 inch low-frequency cone and a high-temperature voice-coil assembly, coupled with a 4-inch passive radiator. A 1 inch wide dispersion titanium coated dome tweeter extends the response to 20 kHz. Frequency response, uniform from 85 Hz to 18 kHz. Pressure sensitivity, 87 dB SPL at 1 meter (85 dB at 4 feet) on axis with one watt of band-limited pink noise from 500 Hz to 3 kHz (ref. 20µPa). Minimum impedance, 8.2 ohms. The loudspeaker shall be 349.9 mm (13.77 in) by 188.3 mm (7.42 in) and 96.5 mm (3.80 in) deep. Weight shall be 2.9 kg (6.5 lb) each. The flush-mounted loudspeaker package shall be the Electro-Voice model FM4.2.

Block diagram:

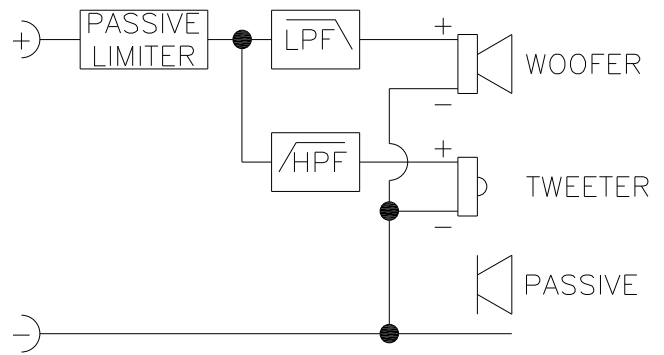

Dimensions:

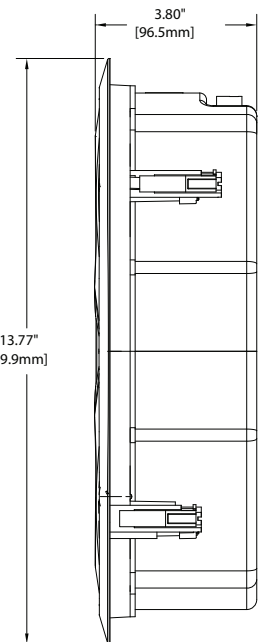
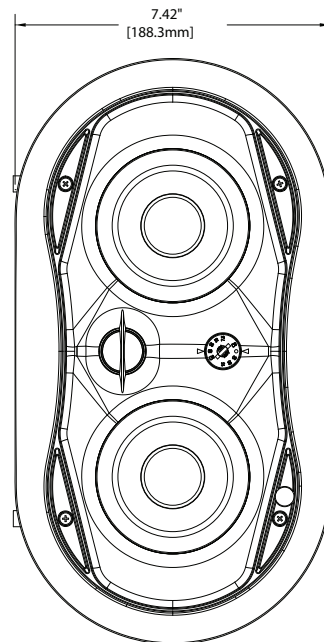
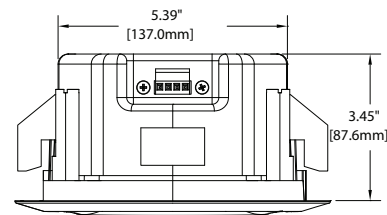

Frequency response and impedance:

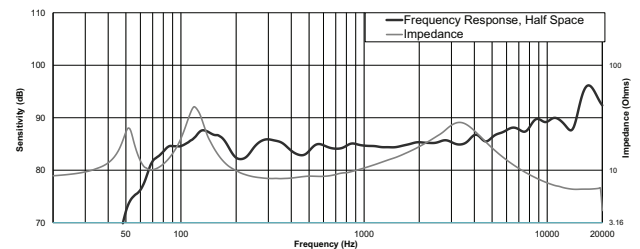

Beamwidth:

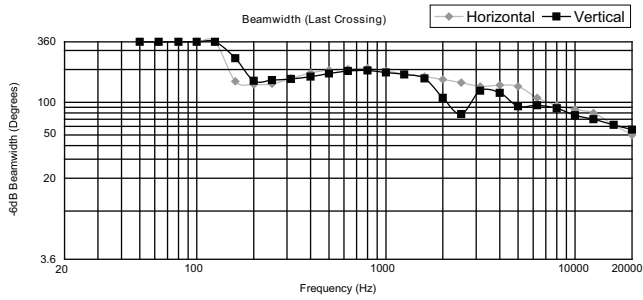

Directivity:

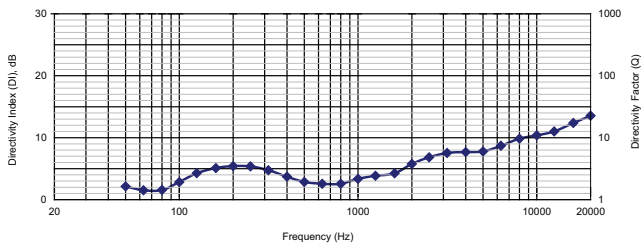

Compatible System Solutions, Electronics:

PA2400T 2x400 70v Power Amplifier

PA2250T 2x250 70v Power Amplifier

PA2450L 2x450 Power Amplifier

PA4150L 4x150 Power Amplifier

Parts included

Quantity	Component
2	Ceiling speakers
1	User manual
1	Datasheet
1	Warranty card
2	Grilles
2	Paint shields

Ordering information

EVID FM4.2

4 inch 2-way w/passive radiator, fully sealed, 30W (8 Ohms) / 100 V (30/15/7.5/3.75W); white, price per pair

Order number **FM4.2**

Represented by:

Germany:

Bosch Sicherheitssysteme GmbH
Robert-Bosch-Ring 5
85630 Grasbrunn
Germany

Bosch Security Systems, Inc.
12000 Portland Avenue South
Burnsville MN 55337
USA

www.electrovoice.com